



⚠ Read this manual carefully before operating this vehicle.

OWNER'S MANUAL

MT-07

MT07

MT07A

1WS-28199-ER

 **Read this manual carefully before operating this vehicle. This manual should stay with this vehicle if it is sold.**



YAMAHA MOTOR ELECTRONICS CO., LTD.
1450-6, Mori, Mori-machi, Shuchi-gun, Shizuoka-ken, 437-0292 Japan

DECLARATION of CONFORMITY

We

Company: YAMAHA MOTOR ELECTRONICS CO., LTD.
Address: 1450-6, Mori, Mori-Machi, Shuchi-gun, Shizuoka-Ken, 437-0292 Japan

Hereby declare that the product:

Kind of equipment: IMMOBILIZER
Type-designation: SSL-00

is in compliance with following norm(s) or documents:

R&TTE Directive(1999/5/EC)
EN300 330-2 v1.3.1(2006-01), EN300 330-2 v1.5.1(2010-02)
EN60950-1:2006/A11:2009
Two or Three-Wheel Motor Vehicles Directive(97/24/EC: Chapter 8, EMC)

Place of issue: Shizuoka, Japan

Date of issue: 1 Aug. 2002

Revision record

No.	Contents	Date
1	To change contact person and integrate type-designation.	9 Jun. 2005
2	Version up the norm of EN60950 to EN60950-1	27 Feb. 2006
3	To change company name	1 Mar. 2007
4	version up of the following norm: • EN300 330-2 v1.1.1 to EN300 330-2 v1.3.1 and EN300 330-2 v1.5.1 • EN60950-1:2001 to EN60950-1:2006/A11:2009	8 Jul. 2010

General manager of quality assurance div.



Welcome to the Yamaha world of motorcycling!

As the owner of the MT07/MT07A, you are benefiting from Yamaha's vast experience and newest technology regarding the design and manufacture of high-quality products, which have earned Yamaha a reputation for dependability.

Please take the time to read this manual thoroughly, so as to enjoy all advantages of your MT07/MT07A. The Owner's Manual does not only instruct you in how to operate, inspect and maintain your motorcycle, but also in how to safeguard yourself and others from trouble and injury.

In addition, the many tips given in this manual will help keep your motorcycle in the best possible condition. If you have any further questions, do not hesitate to contact your Yamaha dealer.

The Yamaha team wishes you many safe and pleasant rides. So, remember to put safety first!

Yamaha continually seeks advancements in product design and quality. Therefore, while this manual contains the most current product information available at the time of printing, there may be minor discrepancies between your motorcycle and this manual. If there is any question concerning this manual, please consult a Yamaha dealer.



 **WARNING**

Please read this manual carefully and completely before operating this motorcycle.

IMPORTANT MANUAL INFORMATION

EAU10134

Particularly important information is distinguished in this manual by the following notations:

	This is the safety alert symbol. It is used to alert you to potential personal injury hazards. Obey all safety messages that follow this symbol to avoid possible injury or death.
 WARNING	A WARNING indicates a hazardous situation which, if not avoided, could result in death or serious injury.
NOTICE	A NOTICE indicates special precautions that must be taken to avoid damage to the vehicle or other property.
TIP	A TIP provides key information to make procedures easier or clearer.

*Product and specifications are subject to change without notice.

IMPORTANT MANUAL INFORMATION

EAU10201

**MT07/MT07A
OWNER'S MANUAL
©2014 by Yamaha Motor Co., Ltd.
1st edition, August 2014
All rights reserved.
Any reprinting or unauthorized use
without the written permission of
Yamaha Motor Co., Ltd.
is expressly prohibited.
Printed in Japan.**

TABLE OF CONTENTS

SAFETY INFORMATION	1-1	Sidestand	3-24	Tires	6-15
DESCRIPTION	2-1	Ignition circuit cut-off system	3-25	Cast wheels	6-18
Left view	2-1	Auxiliary DC connector	3-27	Adjusting the clutch lever free play.....	6-18
Right view.....	2-2	FOR YOUR SAFETY –		Checking the brake lever free play.....	6-19
Controls and instruments	2-3	PRE-OPERATION CHECKS	4-1	Brake light switches	6-19
INSTRUMENT AND CONTROL		OPERATION AND IMPORTANT		Checking the front and rear brake pads	6-20
FUNCTIONS	3-1	RIDING POINTS	5-1	Checking the brake fluid level	6-21
Immobilizer system.....	3-1	Starting the engine.....	5-1	Changing the brake fluid	6-22
Main switch/steering lock.....	3-2	Shifting	5-2	Drive chain slack.....	6-22
Indicator lights and warning lights.....	3-3	Tips for reducing fuel consumption.....	5-3	Cleaning and lubricating the drive chain.....	6-24
Multi-function meter unit	3-6	Engine break-in	5-3	Checking and lubricating the cables.....	6-25
Handlebar switches	3-13	Parking	5-4	Checking and lubricating the throttle grip and cable	6-25
Clutch lever	3-14	PERIODIC MAINTENANCE AND		Checking and lubricating the brake and shift pedals.....	6-25
Shift pedal	3-14	ADJUSTMENT	6-1	Checking and lubricating the brake and clutch levers	6-26
Brake lever.....	3-14	Owner’s tool kit.....	6-2	Checking and lubricating the sidestand.....	6-27
Brake pedal	3-15	Periodic maintenance chart for the emission control system.....	6-3	Lubricating the rear suspension ...	6-27
ABS (for ABS models)	3-15	General maintenance and lubrication chart.....	6-4	Lubricating the swingarm pivots.....	6-27
Fuel tank cap	3-16	Checking the spark plugs	6-8	Checking the front fork.....	6-28
Fuel.....	3-17	Engine oil and oil filter cartridge.....	6-9	Checking the steering.....	6-28
Fuel tank breather hose and overflow hose.....	3-18	Coolant.....	6-11	Checking the wheel bearings	6-29
Catalytic converter	3-19	Replacing the air filter element and cleaning the check hose.....	6-14	Battery	6-29
Seats	3-19	Checking the throttle grip free play	6-15		
Helmet holding cable.....	3-21	Valve clearance	6-15		
Storage compartment	3-22				
Adjusting the shock absorber assembly.....	3-23				
Luggage strap holders	3-24				

TABLE OF CONTENTS

Replacing the fuses.....	6-31
Replacing the headlight bulb.....	6-32
Tail/brake light.....	6-34
Replacing a turn signal light bulb	6-34
Replacing the license plate light bulb	6-35
Replacing the auxiliary light bulb	6-36
Supporting the motorcycle.....	6-36
Front wheel (for non-ABS models).....	6-37
Rear wheel (for non-ABS models).....	6-39
Troubleshooting	6-41
Troubleshooting charts	6-42

MOTORCYCLE CARE AND

STORAGE	7-1
Matte color caution	7-1
Care	7-1
Storage.....	7-3

SPECIFICATIONS.....

8-1

CONSUMER INFORMATION.....

Identification numbers.....

9-1

INDEX.....

10-1

EAU1028B

Be a Responsible Owner

As the vehicle's owner, you are responsible for the safe and proper operation of your motorcycle.

Motorcycles are single-track vehicles. Their safe use and operation are dependent upon the use of proper riding techniques as well as the expertise of the operator. Every operator should know the following requirements before riding this motorcycle.

He or she should:

- Obtain thorough instructions from a competent source on all aspects of motorcycle operation.
- Observe the warnings and maintenance requirements in this Owner's Manual.
- Obtain qualified training in safe and proper riding techniques.
- Obtain professional technical service as indicated in this Owner's Manual and/or when made necessary by mechanical conditions.

- Never operate a motorcycle without proper training or instruction. Take a training course. Beginners should receive training from a certified instructor. Contact an authorized motorcycle dealer to find out about the training courses nearest you.

Safe Riding

Perform the pre-operation checks each time you use the vehicle to make sure it is in safe operating condition. Failure to inspect or maintain the vehicle properly increases the possibility of an accident or equipment damage. See page 4-1 for a list of pre-operation checks.

- This motorcycle is designed to carry the operator and a passenger.
- The failure of motorists to detect and recognize motorcycles in traffic is the predominating cause of automobile/motorcycle accidents. Many accidents have been caused by an automobile driver who did not see the motorcycle. Making yourself conspicuous ap-

pears to be very effective in reducing the chance of this type of accident.

Therefore:

- Wear a brightly colored jacket.
- Use extra caution when you are approaching and passing through intersections, since intersections are the most likely places for motorcycle accidents to occur.
- Ride where other motorists can see you. Avoid riding in another motorist's blind spot.
- Never maintain a motorcycle without proper knowledge. Contact an authorized motorcycle dealer to inform you on basic motorcycle maintenance. Certain maintenance can only be carried out by certified staff.

- Many accidents involve inexperienced operators. In fact, many operators who have been involved in accidents do not even have a current motorcycle license.
 - Make sure that you are qualified and that you only lend your motorcycle to other qualified operators.
 - Know your skills and limits. Staying within your limits may help you to avoid an accident.
 - We recommend that you practice riding your motorcycle where there is no traffic until you have become thoroughly familiar with the motorcycle and all of its controls.
- Many accidents have been caused by error of the motorcycle operator. A typical error made by the operator is veering wide on a turn due to excessive speed or undercornering (insufficient lean angle for the speed).
 - Always obey the speed limit and never travel faster than warranted by road and traffic conditions.
 - Always signal before turning or changing lanes. Make sure that other motorists can see you.
- The posture of the operator and passenger is important for proper control.
 - The operator should keep both hands on the handlebar and both feet on the operator footrests during operation to maintain control of the motorcycle.
 - The passenger should always hold onto the operator, the seat strap or grab bar, if equipped, with both hands and keep both feet on the passenger footrests. Never carry a passenger unless he or she can firmly place both feet on the passenger footrests.
- Never ride under the influence of alcohol or other drugs.
- This motorcycle is designed for on-road use only. It is not suitable for off-road use.

Protective Apparel

The majority of fatalities from motorcycle accidents are the result of head injuries. The use of a safety helmet is the single most critical factor in the prevention or reduction of head injuries.

- Always wear an approved helmet.
- Wear a face shield or goggles. Wind in your unprotected eyes could contribute to an impairment of vision that could delay seeing a hazard.
- The use of a jacket, heavy boots, trousers, gloves, etc., is effective in preventing or reducing abrasions or lacerations.
- Never wear loose-fitting clothes, otherwise they could catch on the control levers, footrests, or wheels and cause injury or an accident.
- Always wear protective clothing that covers your legs, ankles, and feet. The engine or exhaust system become very hot during or after operation and can cause burns.
- A passenger should also observe the above precautions.

SAFETY INFORMATION

1

Avoid Carbon Monoxide Poisoning

All engine exhaust contains carbon monoxide, a deadly gas. Breathing carbon monoxide can cause headaches, dizziness, drowsiness, nausea, confusion, and eventually death.

Carbon Monoxide is a colorless, odorless, tasteless gas which may be present even if you do not see or smell any engine exhaust. Deadly levels of carbon monoxide can collect rapidly and you can quickly be overcome and unable to save yourself. Also, deadly levels of carbon monoxide can linger for hours or days in enclosed or poorly ventilated areas. If you experience any symptoms of carbon monoxide poisoning, leave the area immediately, get fresh air, and SEEK MEDICAL TREATMENT.

- Do not run engine indoors. Even if you try to ventilate engine exhaust with fans or open windows and doors, carbon monoxide can rapidly reach dangerous levels.
- Do not run engine in poorly ventilated or partially enclosed areas such as barns, garages, or carports.

- Do not run engine outdoors where engine exhaust can be drawn into a building through openings such as windows and doors.

Loading

Adding accessories or cargo to your motorcycle can adversely affect stability and handling if the weight distribution of the motorcycle is changed. To avoid the possibility of an accident, use extreme caution when adding cargo or accessories to your motorcycle. Use extra care when riding a motorcycle that has added cargo or accessories. Here, along with the information about accessories below, are some general guidelines to follow if loading cargo to your motorcycle:

The total weight of the operator, passenger, accessories and cargo must not exceed the maximum load limit.

Operation of an overloaded vehicle could cause an accident.

Maximum load:

MT07 176 kg (388 lb)
MT07A 173 kg (381 lb)

When loading within this weight limit, keep the following in mind:

- Cargo and accessory weight should be kept as low and close to the motorcycle as possible. Securely pack your heaviest items as close to the center of the vehicle as possible and make sure to distribute the weight as evenly as possible on both sides of the motorcycle to minimize imbalance or instability.
- Shifting weights can create a sudden imbalance. Make sure that accessories and cargo are securely attached to the motorcycle before riding. Check accessory mounts and cargo restraints frequently.
- Properly adjust the suspension for your load (suspension-adjustable models only), and check the condition and pressure of your tires.
- Never attach any large or heavy items to the handlebar, front fork, or front fender. These items, including such cargo as sleeping bags, duffel bags, or

tents, can create unstable handling or a slow steering response.

- **This vehicle is not designed to pull a trailer or to be attached to a sidecar.**

Genuine Yamaha Accessories

Choosing accessories for your vehicle is an important decision. Genuine Yamaha accessories, which are available only from a Yamaha dealer, have been designed, tested, and approved by Yamaha for use on your vehicle.

Many companies with no connection to Yamaha manufacture parts and accessories or offer other modifications for Yamaha vehicles. Yamaha is not in a position to test the products that these aftermarket companies produce. Therefore, Yamaha can neither endorse nor recommend the use of accessories not sold by Yamaha or modifications not specifically recommended by Yamaha, even if sold and installed by a Yamaha dealer.

Aftermarket Parts, Accessories, and Modifications

While you may find aftermarket products similar in design and quality to genuine Yamaha accessories, recognize that some aftermarket accessories or modifications are not suitable because of potential safety hazards to you or others. Installing aftermarket products or having other modifications performed to your vehicle that change any of the vehicle's design or operation characteristics can put you and others at greater risk of serious injury or death. You are responsible for injuries related to changes in the vehicle.

Keep the following guidelines in mind, as well as those provided under "Loading" when mounting accessories.

- Never install accessories or carry cargo that would impair the performance of your motorcycle. Carefully inspect the accessory before using it to make sure that it does not in any way reduce ground clearance or cornering clearance, limit suspension travel,

steering travel or control operation, or obscure lights or reflectors.

- Accessories fitted to the handlebar or the front fork area can create instability due to improper weight distribution or aerodynamic changes. If accessories are added to the handlebar or front fork area, they must be as lightweight as possible and should be kept to a minimum.
- Bulky or large accessories may seriously affect the stability of the motorcycle due to aerodynamic effects. Wind may attempt to lift the motorcycle, or the motorcycle may become unstable in cross winds. These accessories may also cause instability when passing or being passed by large vehicles.
- Certain accessories can displace the operator from his or her normal riding position. This improper position limits the freedom of movement of the

SAFETY INFORMATION

1

operator and may limit control ability, therefore, such accessories are not recommended.

- Use caution when adding electrical accessories. If electrical accessories exceed the capacity of the motorcycle's electrical system, an electric failure could result, which could cause a dangerous loss of lights or engine power.

Aftermarket Tires and Rims

The tires and rims that came with your motorcycle were designed to match the performance capabilities and to provide the best combination of handling, braking, and comfort. Other tires, rims, sizes, and combinations may not be appropriate. Refer to page 6-15 for tire specifications and more information on replacing your tires.

Transporting the Motorcycle

Be sure to observe following instructions before transporting the motorcycle in another vehicle.

- Remove all loose items from the motorcycle.

- Check that the fuel cock (if equipped) is in the "OFF" position and that there are no fuel leaks.
- Point the front wheel straight ahead on the trailer or in the truck bed, and choke it in a rail to prevent movement.
- Shift the transmission in gear (for models with a manual transmission).
- Secure the motorcycle with tie-downs or suitable straps that are attached to solid parts of the motorcycle, such as the frame or upper front fork triple clamp (and not, for example, to rubber-mounted handlebars or turn signals, or parts that could break). Choose the location for the straps carefully so the straps will not rub against painted surfaces during transport.
- The suspension should be compressed somewhat by the tie-downs, if possible, so that the motorcycle will not bounce excessively during transport.

Left view

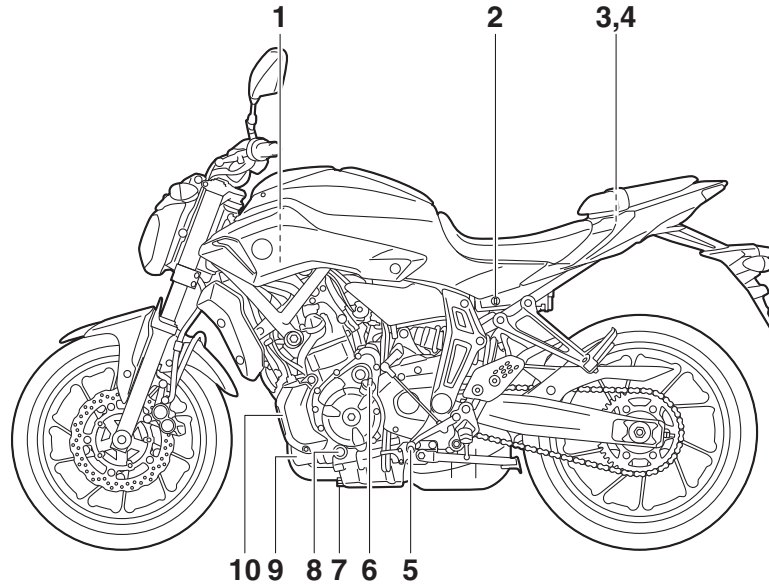

1. Auxiliary DC connector (page 3-27)
2. Seat lock (page 3-19)
3. Storage compartment (page 3-22)
4. Owner's tool kit (page 6-2)
5. Shift pedal (page 3-14)
6. Engine oil filler cap (page 6-9)
7. Engine oil drain bolt (page 6-9)
8. Engine oil level check window (page 6-9)

9. Engine oil filter cartridge (page 6-9)
10. Coolant reservoir (page 6-11)

DESCRIPTION

EAU10421

Right view

2

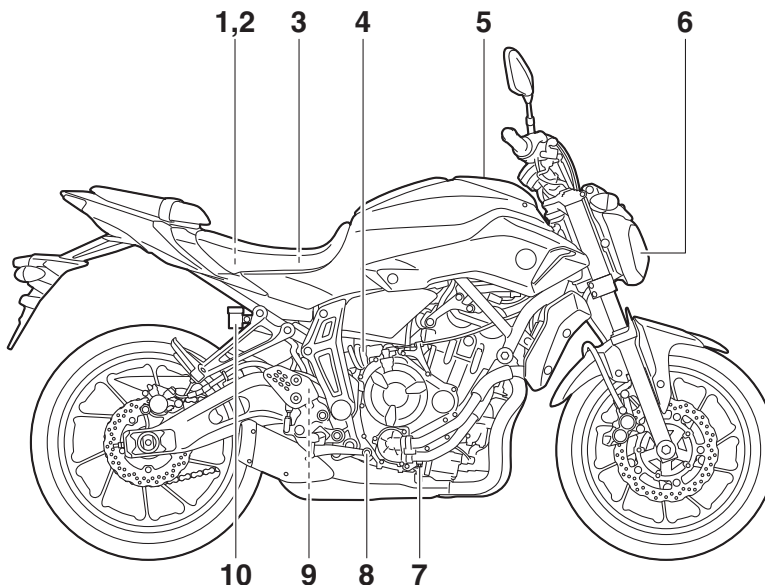

1. Main fuse (page 6-31)

2. Fuse box (page 6-31)

3. Battery (page 6-29)

4. Shock absorber assembly spring preload adjusting ring (page 3-23)

5. Fuel tank cap (page 3-16)

6. Headlight (page 6-32)

7. Coolant drain bolt (page 6-12)

8. Brake pedal (page 3-15)

9. Rear brake light switch (page 6-19)

10. Rear brake fluid reservoir (page 6-21)

Controls and instruments

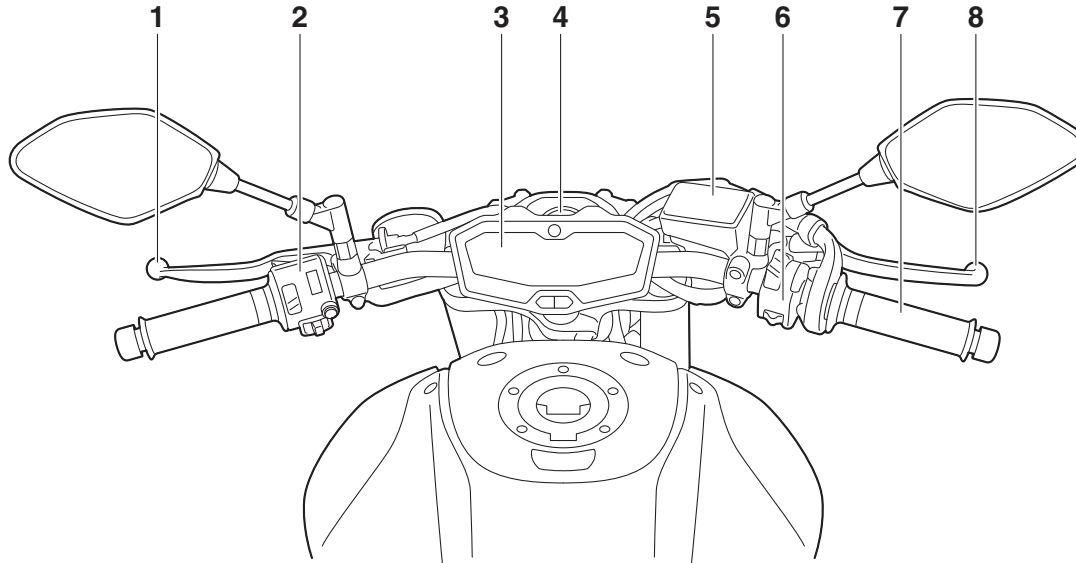

1. Clutch lever (page 3-14)
2. Left handlebar switches (page 3-13)
3. Multi-function meter unit (page 3-6)
4. Main switch/steering lock (page 3-2)
5. Front brake fluid reservoir (page 6-21)
6. Right handlebar switches (page 3-13)
7. Throttle grip (page 6-15)
8. Brake lever (page 3-14)

INSTRUMENT AND CONTROL FUNCTIONS

Immobilizer system

EAU10978

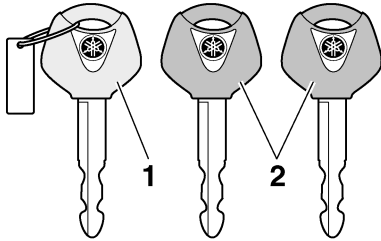

1. Code re-registering key (red bow)
2. Standard keys (black bow)

This vehicle is equipped with an immobilizer system to help prevent theft by re-registering codes in the standard keys. This system consists of the following:

- a code re-registering key (with a red bow)
- two standard keys (with a black bow) that can be re-registered with new codes
- a transponder (which is installed in the code re-registering key)
- an immobilizer unit
- an ECU

- an immobilizer system indicator light (See page 3-5.)

The key with the red bow is used to register codes in each standard key. Since re-registering is a difficult process, take the vehicle along with all three keys to a Yamaha dealer to have them re-registered. Do not use the key with the red bow for driving. It should only be used for re-registering the standard keys. Always use a standard key for driving.

ECA11822

NOTICE

- **DO NOT LOSE THE CODE RE-REGISTERING KEY! CONTACT YOUR DEALER IMMEDIATELY IF IT IS LOST!** If the code re-registering key is lost, registering new codes in the standard keys is impossible. The standard keys can still be used to start the vehicle, however if code re-registering is required (i.e., if a new standard key is made or all keys are lost) the entire immobilizer system must be replaced. Therefore, it is highly recom-

mended to use either standard key and keep the code re-registering key in a safe place.

- Do not submerge any key in water.
- Do not expose any key to excessively high temperatures.
- Do not place any key close to magnets (this includes, but not limited to, products such as speakers, etc.).
- Do not place items that transmit electrical signals close to any key.
- Do not place heavy items on any key.
- Do not grind any key or alter its shape.
- Do not disassemble the plastic part of any key.
- Do not put two keys of any immobilizer system on the same key ring.
- Keep the standard keys as well as keys of other immobilizer systems away from this vehicle's code re-registering key.

INSTRUMENT AND CONTROL FUNCTIONS

- Keep other immobilizer system keys away from the main switch as they may cause signal interference.

Main switch/steering lock

EAU10473

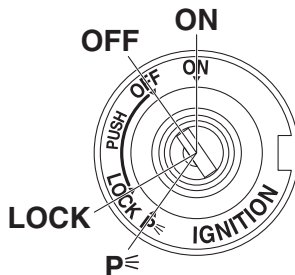

The main switch/steering lock controls the ignition and lighting systems, and is used to lock the steering. The various positions are described below.

TIP

Be sure to use the standard key (black bow) for regular use of the vehicle. To minimize the risk of losing the code re-registering key (red bow), keep it in a safe place and only use it for code re-registering.

EAU38531

ON

All electrical circuits are supplied with power; the meter lighting, taillight, license plate light and auxiliary light come on, and the engine can be started. The key cannot be removed.

TIP

The headlight comes on automatically when the engine is started and stays on until the key is turned to “OFF”, even if the engine stalls.

EAU10662

OFF

All electrical systems are off. The key can be removed.

EAU10062

WARNING

Never turn the key to “OFF” or “LOCK” while the vehicle is moving. Otherwise the electrical systems will be switched off, which may result in loss of control or an accident.

INSTRUMENT AND CONTROL FUNCTIONS

LOCK

The steering is locked, and all electrical systems are off. The key can be removed.

EAU10685

3

To lock the steering

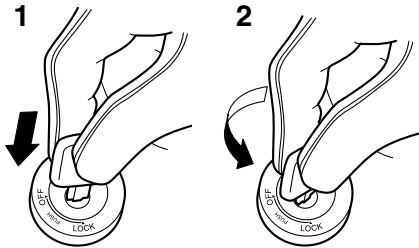

1. Push.
2. Turn.

1. Turn the handlebars all the way to the left.
2. Push the key in from the “OFF” position, and then turn it to “LOCK” while still pushing it.
3. Remove the key.

To unlock the steering

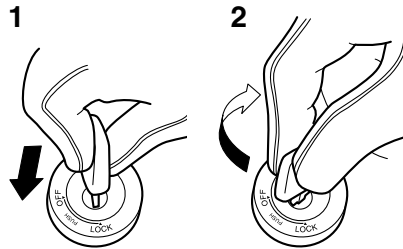

1. Push.
2. Turn.

Push the key in, and then turn it to “OFF” while still pushing it.

P⊥ (Parking)

The hazard lights and turn signal lights can be turned on, but all other electrical systems are off. The key can be removed.

The steering must be locked before the key can be turned to “P⊥”.

EAU59680

ECA20760

NOTICE

Using the hazard or turn signal lights for an extended length of time may cause the battery to discharge.

Indicator lights and warning lights

EAU49395

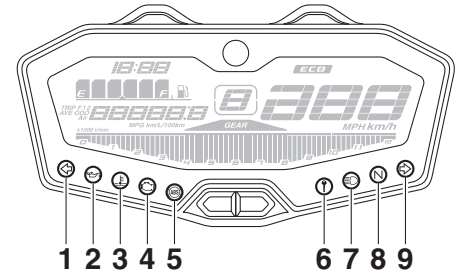

1. Left turn signal indicator light “⤵”
2. Oil pressure warning light “⚠️”
3. Coolant temperature warning light “🌡️”
4. Engine trouble warning light “⚠️”
5. Anti-lock Brake System (ABS) warning light “⊕” (for ABS models)
6. Immobilizer system indicator light “🔑”
7. High beam indicator light “☰”
8. Neutral indicator light “N”
9. Right turn signal indicator light “⤵”

Turn signal indicator lights “⤵” and “⤴”

EAU11031

The corresponding indicator light flashes when the turn signal switch is pushed to the left or right.

INSTRUMENT AND CONTROL FUNCTIONS

Neutral indicator light “N”

EAU11061

This indicator light comes on when the transmission is in the neutral position.

High beam indicator light “ ”

EAU11081

This indicator light comes on when the high beam of the headlight is switched on.

Oil pressure warning light “ ”

EAU59962

This warning light comes on if the engine oil pressure is low.

The electrical circuit of the warning light can be checked by turning the key to “ON”. The warning light should come on again after going off briefly, and then remain on until the engine is started.

If the warning light does not come on initially when the key is turned to “ON”, have a Yamaha dealer check the electrical circuit.

ECA21210

NOTICE

If the warning light comes on when the engine is running, stop the engine immediately and check oil level.

If the oil level is below the minimum level, add sufficient oil of the recommended type to raise it up to the correct level. If the oil pressure warning light remains on even if the oil level is correct, immediately turn the engine off and have a Yamaha dealer check the vehicle.

TIP

If the warning light does not go off after starting the engine, check the engine oil level and add oil if necessary. (See page 6-9.)

If the warning light remains on after adding engine oil, have a Yamaha dealer check the vehicle.

Coolant temperature warning light “ ”

EAU11447

This warning light comes on if the engine overheats. If this occurs, stop the engine immediately and allow the engine to cool.

The electrical circuit of the warning light can be checked by turning the key to “ON”. The warning light should come on for a few seconds, and then go off.

If the warning light does not come on initially when the key is turned to “ON”, or if the warning light remains on, have a Yamaha dealer check the electrical circuit.

ECA10022

NOTICE

Do not continue to operate the engine if it is overheating.

TIP

- For radiator-fan-equipped vehicles, the radiator fan(s) automatically switch on or off according to the coolant temperature in the radiator.
- If the engine overheats, see page 6-43 for further instructions.

Engine trouble warning light “ ”

EAU46443

This warning light comes on if a problem is detected in the electrical circuit monitoring the engine. If this occurs,

INSTRUMENT AND CONTROL FUNCTIONS

have a Yamaha dealer check the self-diagnosis system. (See page 3-11 for an explanation of the self-diagnosis device.)

The electrical circuit of the warning light can be checked by turning the key to “ON”. The warning light should come on for a few seconds, and then go off.

If the warning light does not come on initially when the key is turned to “ON”, or if the warning light remains on, have a Yamaha dealer check the electrical circuit.

TIP

This warning light will come on when the key is turned to “ON” and the start switch is pushed, but this does not indicate a malfunction.

ABS warning light “ EAU58530

In normal operation, the ABS warning light comes on when the key is turned to “ON”, and goes off after traveling at a speed of 10 km/h (6 mi/h) or higher.

If the ABS warning light:

- does not come on when the key is turned to “ON”
- comes on or flashes while riding
- does not go off after traveling at a speed of 10 km/h (6 mi/h) or higher

The ABS may not work correctly. If any of the above occurs, have a Yamaha dealer check the system as soon as possible. (See page 3-15 for an explanation of the ABS.)

EWA16041



If the ABS warning light does not go off after traveling at a speed of 10 km/h (6 mi/h) or higher, or if the warning light comes on or flashes while riding, the brake system reverts to conventional braking. If either of the above occurs, or if the warning light does not come on at all, use extra caution to avoid possible wheel lock during emergency braking. Have a Yamaha dealer check the brake system and electrical circuits as soon as possible.

EAU26878

Immobilizer system indicator light “ The electrical circuit of the indicator light can be checked by turning the key to “ON”. The indicator light should come on for a few seconds, and then go off.

If the indicator light does not come on initially when the key is turned to “ON”, or if the indicator light remains on, have a Yamaha dealer check the electrical circuit.

When the key is turned to “OFF” and 30 seconds have passed, the indicator light will start flashing indicating the immobilizer system is enabled. After 24 hours have passed, the indicator light will stop flashing, however the immobilizer system is still enabled.

The self-diagnosis device also detects problems in the immobilizer system circuits. (See page 3-11 for an explanation of the self-diagnosis device.)

INSTRUMENT AND CONTROL FUNCTIONS

Multi-function meter unit

EAU59973

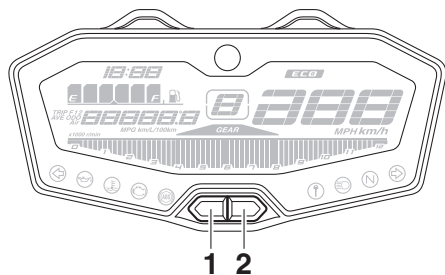

1. Left set button
2. Right set button

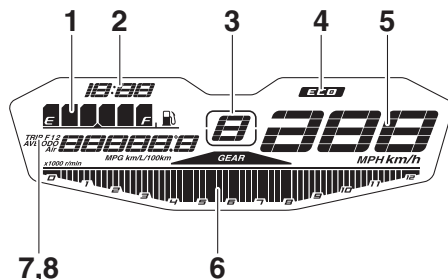

1. Fuel meter
2. Clock
3. Transmission gear display
4. Eco indicator "ECO"
5. Speedometer
6. Tachometer
7. Multi-function display
8. Self-diagnosis device

WARNING

Be sure to stop the vehicle before making any setting changes to the multi-function meter unit. Changing settings while riding can distract the operator and increase the risk of an accident.

The multi-function meter unit is equipped with the following:

- a speedometer

- a tachometer
- a clock
- a fuel meter
- an eco indicator
- a transmission gear display
- a multi-function display
- a self-diagnosis device
- a brightness control mode

TIP

- Be sure to turn the key to "ON" before using the left and right set buttons except for setting the brightness control mode.
- For the U.K. only: To switch the speedometer and multi-function display between kilometers and miles, set the multi-function display to the odometer mode or a tripmeter mode, and then press the left set button for at least three seconds.

Speedometer

The speedometer shows the vehicle's traveling speed.

INSTRUMENT AND CONTROL FUNCTIONS

3

Tachometer

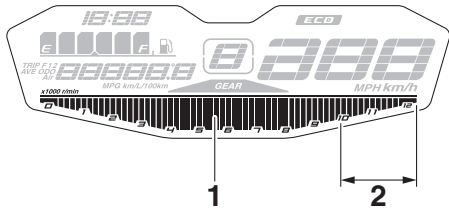

1. Tachometer
2. Tachometer red zone

The tachometer allows the rider to monitor the engine speed and keep it within the ideal power range.

ECA10032

NOTICE

Do not operate the engine in the tachometer red zone.

Red zone: 10000 r/min and above

Clock

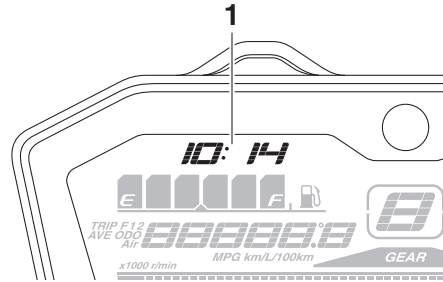

1. Clock

The clock displays when the key is turned to “ON”. In addition, the clock can be displayed for 10 seconds by pushing the left set button when the main switch is in the “OFF”, “LOCK” or “P<” position.

To set the clock

1. Turn the key to “ON”.
2. Push the left set button and right set button together for at least two seconds.
3. When the hour digits start flashing, push the right set button to set the hours.
4. Push the left set button, and the minute digits will start flashing.

5. Push the right set button to set the minutes.
6. Push the left set button and then release it to start the clock.

Fuel meter

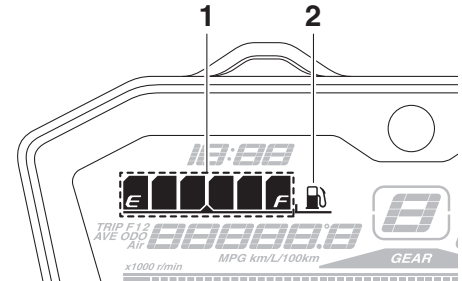

1. Fuel meter
2. Fuel level warning indicator “”

The fuel meter indicates the amount of fuel in the fuel tank. The display segments of the fuel meter disappear towards “E” (Empty) as the fuel level decreases. When the last segment and fuel level warning indicator “” start flashing, refuel as soon as possible.

INSTRUMENT AND CONTROL FUNCTIONS

TIP

This fuel meter is equipped with a self-diagnosis system. If a problem is detected in the electrical circuit, the following cycle is repeated until the malfunction is corrected: fuel level segments and fuel level warning indicator “” flash eight times, then go off for approximately 3 seconds. If this occurs, have a Yamaha dealer check the electrical circuit.

Eco indicator

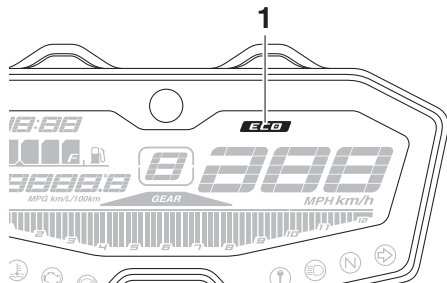

1. Eco indicator “ECO”

This indicator comes on when the vehicle is being operated in an environmentally friendly, fuel-efficient manner. The indicator goes off when the vehicle is stopped.

TIP

Consider the following tips to reduce fuel consumption:

- Avoid high engine speeds during acceleration.
- Travel at a constant speed.
- Select the transmission gear that is appropriate for the vehicle speed.

Transmission gear display

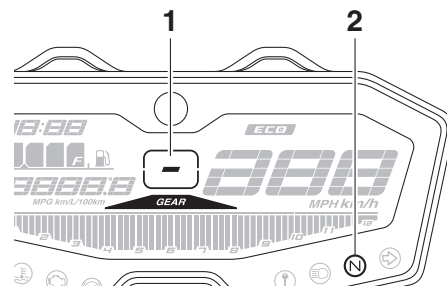

1. Transmission gear display
2. Neutral indicator light “N”

This display shows the selected gear. The neutral position is indicated by “-” and by the neutral indicator light.

Multi-function display

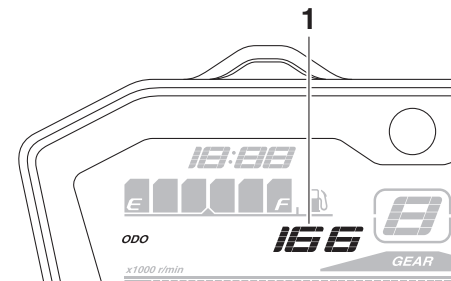

1. Multi-function display

The multi-function display is equipped with the following:

- an odometer
- two tripmeters (which show the distance traveled since they were last set to zero)
- a fuel reserve tripmeter (which shows the distance traveled since the left segment of the fuel meter started flashing)
- a coolant temperature display
- an ambient temperature display

INSTRUMENT AND CONTROL FUNCTIONS

3

- an instantaneous fuel consumption display
- an average fuel consumption display

Push the left set button to switch the display between the odometer mode “ODO”, tripmeter modes “TRIP 1” and “TRIP 2”, instantaneous fuel consumption mode “km/L” or “L/100 km”, average fuel consumption mode “AVE_ _ _ km/L” or “AVE_ _ _ L/100 km”, coolant temperature mode “_ _ °C”, and ambient temperature mode “Air_ _ °C” in the following order:

ODO → TRIP 1 → TRIP 2 → km/L or L/100 km → AVE_ _ _ km/L or AVE_ _ _ L/100 km → _ _ °C → Air_ _ °C → ODO

For the UK only:

Push the left set button to switch the display between the odometer mode “ODO”, tripmeter modes “TRIP 1” and “TRIP 2”, instantaneous fuel consumption mode “km/L”, “L/100 km” or “MPG”, average fuel consumption mode “AVE_ _ _ km/L”, “AVE_ _ _ L/100 km” or “AVE_ _ _ MPG”, coolant

temperature mode “_ _ °C”, and ambient temperature mode “Air_ _ °C” in the following order:

ODO → TRIP 1 → TRIP 2 → km/L, L/100 km or MPG → AVE_ _ _ km/L, AVE_ _ _ L/100 km or AVE_ _ _ MPG → _ _ °C → Air_ _ °C → ODO

TIP

Push the right set button to switch the display in the reverse order.

If the fuel level warning indicator “” and left segment of the fuel meter start flashing, the display automatically changes to the fuel reserve tripmeter mode “TRIP F” and starts counting the distance traveled from that point. In that case, push the left set button to switch the display between the various tripmeter, odometer, instantaneous fuel consumption and average fuel consumption modes in the following order:

TRIP F → km/L or L/100 km → AVE_ _ _ km/L or AVE_ _ _ L/100 km → _ _ °C → Air_ _ °C → ODO → TRIP 1 → TRIP 2 → TRIP F

For the UK only:

TRIP F → km/L, L/100 km or MPG → AVE_ _ _ km/L, AVE_ _ _ L/100 km or AVE_ _ _ MPG → _ _ °C → Air_ _ °C → ODO → TRIP 1 → TRIP 2 → TRIP F

To reset a tripmeter, select it by pushing the left set button, and then push the right set button for at least one second.

If you do not reset the fuel reserve tripmeter manually, it resets itself automatically and the display returns to the prior mode after refueling and traveling 5 km (3 mi).

INSTRUMENT AND CONTROL FUNCTIONS

Instantaneous fuel consumption display

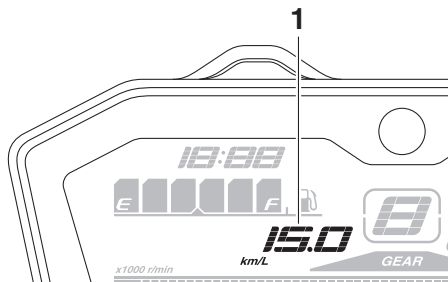

1. Instantaneous fuel consumption display

The instantaneous fuel consumption display can be set to either “km/L”, “L/100 km” or “MPG” (for the UK only).

- “km/L”: The distance that can be traveled on 1.0 L of fuel under the current riding conditions is shown.
- “L/100 km”: The amount of fuel necessary to travel 100 km under the current riding conditions is shown.
- “MPG” (for the UK only): The distance that can be traveled on 1.0 Imp.gal of fuel under the current riding conditions is shown.

To switch between the instantaneous fuel consumption displays, push the left set button for one second when one of the displays is shown.

TIP

If traveling at speeds under 20 km/h (12 mi/h), “_ _ . _” is displayed.

Average fuel consumption mode

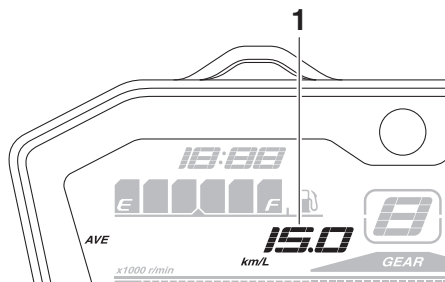

1. Average fuel consumption display

The average fuel consumption display can be set to either “AVE_ _ . _ km/L”, “AVE_ _ . _ L/100 km” or “AVE_ _ . _ MPG” (for the UK only).

This display shows the average fuel consumption since it was last reset.

- “AVE_ _ . _ km/L”: The average distance that can be traveled on 1.0 L of fuel is shown.
- “AVE_ _ . _ L/100 km”: The average amount of fuel necessary to travel 100 km is shown.
- “AVE_ _ . _ MPG” (for the UK only): The average distance that can be traveled on 1.0 Imp.gal of fuel is shown.

To switch between the average fuel consumption displays, push the left set button for one second when one of the displays is shown.

To reset the average fuel consumption display, select it by pushing the left set button, and then push the right set button for at least one second.

TIP

After resetting an average fuel consumption display, “_ _ . _” is shown for that display until the vehicle has traveled 1 km (0.6 mi).

INSTRUMENT AND CONTROL FUNCTIONS

Coolant temperature display

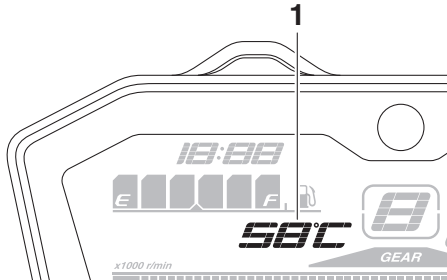

1. Coolant temperature display

This display shows the coolant temperature from 40 °C to 116 °C in 1 °C increments.

If the message “HI” flashes, stop the vehicle, then stop the engine, and let the engine cool. (See page 6-43.)

TIP

- When the coolant temperature is below 40 °C, “LO” will be displayed.
- The coolant temperature varies with changes in the weather and engine load.

Ambient temperature display

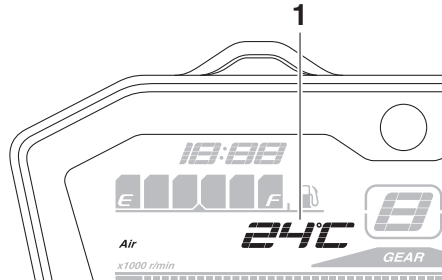

1. Ambient temperature display



This display shows the ambient temperature from -9 °C to 99 °C in 1 °C increments. The temperature displayed may vary from the ambient temperature.

TIP

- When the ambient temperature is below -9 °C, “LO” will be displayed.
- The accuracy of the temperature reading may be affected when riding slowly [approximately under 20 km/h (12.5 mi/h)] or when stopped at traffic signals, railroad crossings, etc.

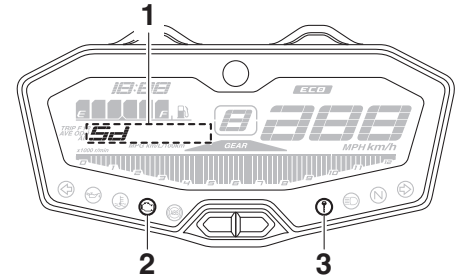
Self-diagnosis device



1. Error code display
2. Engine trouble warning light “”
3. Immobilizer system indicator light “”

This model is equipped with a self-diagnosis device for various electrical circuits.

If a problem is detected in any of those circuits, the engine trouble warning light will come on and the display will indicate an error code.

If the display indicates any error codes, note the code number, and then have a Yamaha dealer check the vehicle.

The self-diagnosis device also detects problems in the immobilizer system circuits.

INSTRUMENT AND CONTROL FUNCTIONS

If a problem is detected in the immobilizer system circuits, the immobilizer system indicator light will flash and the display will indicate an error code.

TIP

If the display indicates error code 52, this could be caused by transponder interference. If this error code appears, try the following.

1. Use the code re-registering key to start the engine.

TIP

Make sure there are no other immobilizer keys close to the main switch, and do not keep more than one immobilizer key on the same key ring! Immobilizer system keys may cause signal interference, which may prevent the engine from starting.

2. If the engine starts, turn it off and try starting the engine with the standard keys.
3. If one or both of the standard keys do not start the engine, take the vehicle, the code re-registering

key and both standard keys to a Yamaha dealer and have the standard keys re-registered.

ECA11591

NOTICE

If the display indicates an error code, the vehicle should be checked as soon as possible in order to avoid engine damage.

Brightness control mode

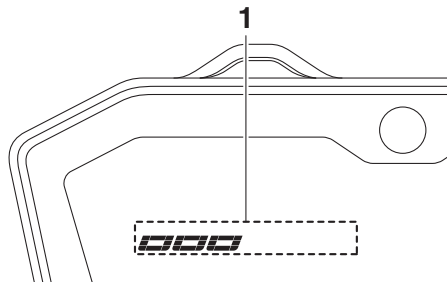

1. Brightness level display

This function allows you to adjust the brightness of the multi-function meter unit panel to suit the outside lighting conditions.

To adjust the brightness

1. Turn the key to “OFF”.

2. Push and hold the left set button.
3. Turn the key to “ON” and continue pushing the left set button until the display switches to the brightness control mode.
4. Push the right set button to set the brightness level.
5. Push the left set button to confirm the selected brightness level and exit the brightness control mode.

INSTRUMENT AND CONTROL FUNCTIONS

Handlebar switches

Left

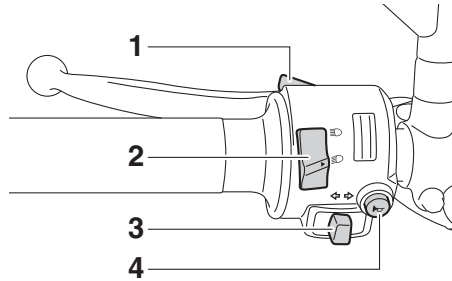

1. Pass switch “ $\equiv\bigcirc$ ”
2. Dimmer switch “ $\equiv\bigcirc/\bigcirc\equiv$ ”
3. Turn signal switch “ \leftarrow/\rightarrow ”
4. Horn switch “ H ”

Right

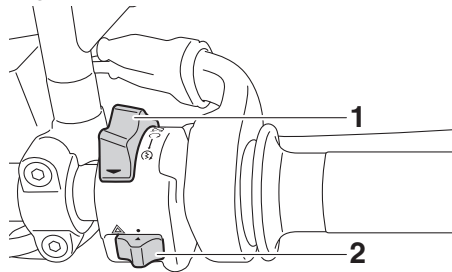

1. Start/Engine stop switch “ $\text{S}/\bigcirc/\text{X}$ ”
2. Hazard switch “ \triangle ”

EAU1234G

Pass switch “ $\equiv\bigcirc$ ”

Press this switch to flash the headlight.

EAU12351

Dimmer switch “ $\equiv\bigcirc/\bigcirc\equiv$ ”

Set this switch to “ $\equiv\bigcirc$ ” for the high beam and to “ $\bigcirc\equiv$ ” for the low beam.

EAU12401

Turn signal switch “ \leftarrow/\rightarrow ”

To signal a right-hand turn, push this switch to “ \rightarrow ”. To signal a left-hand turn, push this switch to “ \leftarrow ”. When released, the switch returns to the center position. To cancel the turn signal lights, push the switch in after it has returned to the center position.

EAU12461

Horn switch “ H ”

Press this switch to sound the horn.

EAU12501

Start/Engine stop switch “ $\text{S}/\bigcirc/\text{X}$ ”

To crank the engine with the starter, set this switch to “ \bigcirc ”, and then push the “ S ” side of the switch. See page 5-1 for starting instructions prior to starting the engine.

EAU54211

Set this switch to “ X ” to stop the engine in case of an emergency, such as when the vehicle overturns or when the throttle cable is stuck.

The engine trouble warning light will come on when the key is turned to “ON” and the start switch is pushed, but this does not indicate a malfunction.

EAU41701

Hazard switch “ \triangle ”

With the key in the “ON” or “ P ” position, use this switch to turn on the hazard lights (simultaneous flashing of all turn signal lights).

EAU12734

The hazard lights are used in case of an emergency or to warn other drivers when your vehicle is stopped where it might be a traffic hazard.

NOTICE

Do not use the hazard lights for an extended length of time with the engine not running, otherwise the battery may discharge.

ECA10062

Clutch lever

EAU12821

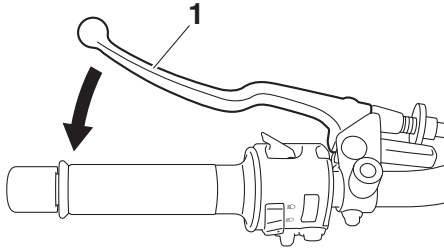

1. Clutch lever

The clutch lever is located at the left handlebar grip. To disengage the clutch, pull the lever toward the handlebar grip. To engage the clutch, release the lever. The lever should be pulled rapidly and released slowly for smooth clutch operation.

The clutch lever is equipped with a clutch switch, which is part of the ignition circuit cut-off system. (See page 3-25.)

Shift pedal

EAU12872

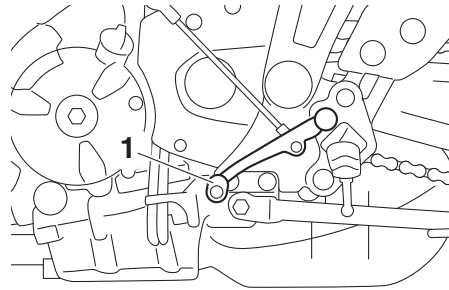

1. Shift pedal

The shift pedal is located on the left side of the motorcycle and is used in combination with the clutch lever when shifting the gears of the 6-speed constant-mesh transmission equipped on this motorcycle.

Brake lever

EAU26825

The brake lever is located on the right side of the handlebar. To apply the front brake, pull the lever toward the throttle grip.

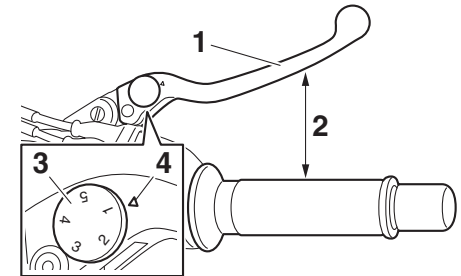

1. Brake lever
2. Distance between brake lever and throttle grip
3. Brake lever position adjusting dial
4. “△” mark

The brake lever is equipped with a brake lever position adjusting dial. To adjust the distance between the brake lever and the throttle grip, turn the adjusting dial while holding the lever pushed away from the throttle grip. Make sure that the appropriate setting on the adjusting dial is aligned with the “△” mark on the brake lever.

INSTRUMENT AND CONTROL FUNCTIONS

Brake pedal

EAU12942

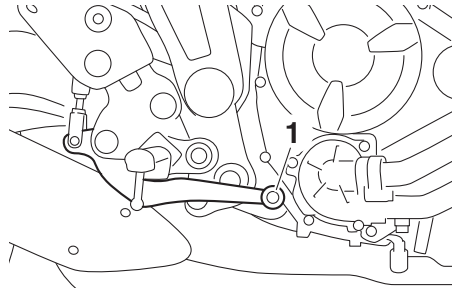

1. Brake pedal

The brake pedal is on the right side of the motorcycle. To apply the rear brake, press down on the brake pedal.

ABS (for ABS models)

EAU60020

The Yamaha ABS (Anti-lock Brake System) features a dual electronic control system, which acts on the front and rear brakes independently.

Operate the brakes with ABS as you would conventional brakes. If the ABS is activated, a pulsating sensation may be felt at the brake lever or brake pedal. In this situation, continue to apply the brakes and let the ABS work; do not “pump” the brakes as this will reduce braking effectiveness.

EWA16051

WARNING

Always keep a sufficient distance from the vehicle ahead to match the riding speed even with ABS.

- **The ABS performs best with long braking distances.**
- **On certain surfaces, such as rough or gravel roads, the braking distance may be longer with the ABS than without.**

The ABS is monitored by an ECU, which will revert the system to conventional braking if a malfunction occurs.

TIP

- The ABS performs a self-diagnosis test each time the vehicle first starts off after the key is turned to “ON” and the vehicle has traveled at a speed of 10 km/h (6 mi/h) or higher. During this test, a “clicking” noise can be heard from the hydraulic control unit, and if the brake lever or brake pedal is even slightly applied, a vibration can be felt at the lever and pedal, but these do not indicate a malfunction.
- This ABS has a test mode which allows the owner to experience the pulsation at the brake lever or brake pedal when the ABS is operating. However, special tools are required, so please consult your Yamaha dealer when performing this test.

INSTRUMENT AND CONTROL FUNCTIONS

ECA20100

NOTICE

Be careful not to damage the wheel sensor or wheel sensor rotor; otherwise, improper performance of the ABS will result.

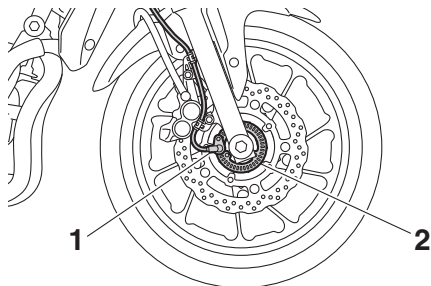

1. Front wheel sensor
2. Front wheel sensor rotor

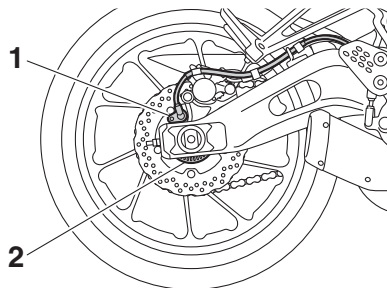

1. Rear wheel sensor
2. Rear wheel sensor rotor

EAU13075

Fuel tank cap

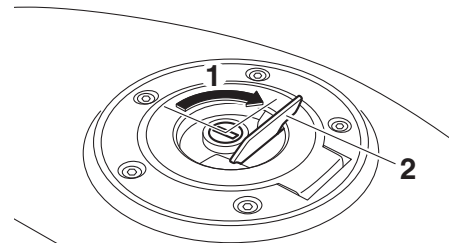

1. Unlock.
2. Fuel tank cap lock cover

To open the fuel tank cap

Open the fuel tank cap lock cover, insert the key into the lock, and then turn it 1/4 turn clockwise. The lock will be released and the fuel tank cap can be opened.

To close the fuel tank cap

1. Push the fuel tank cap into position with the key inserted in the lock.
2. Turn the key counterclockwise to the original position, remove it, and then close the lock cover.

3

INSTRUMENT AND CONTROL FUNCTIONS

TIP _____

The fuel tank cap cannot be closed unless the key is in the lock. In addition, the key cannot be removed if the cap is not properly closed and locked.

3

⚠ WARNING _____

EWA11092

Make sure that the fuel tank cap is properly closed after filling fuel. Leaking fuel is a fire hazard.

Fuel

Make sure there is sufficient gasoline in the tank.

EAU13222

EWA10882

⚠ WARNING _____

Gasoline and gasoline vapors are extremely flammable. To avoid fires and explosions and to reduce the risk of injury when refueling, follow these instructions.

1. Before refueling, turn off the engine and be sure that no one is sitting on the vehicle. Never refuel while smoking, or while in the vicinity of sparks, open flames, or other sources of ignition such as the pilot lights of water heaters and clothes dryers.
2. Do not overfill the fuel tank. When refueling, be sure to insert the pump nozzle into the fuel tank filler hole. Stop filling when the fuel reaches the bottom of the filler tube. Because fuel expands when it heats up, heat from the engine or the sun can cause fuel to spill out of the fuel tank.

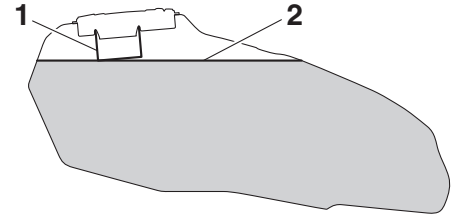

1. Fuel tank filler tube
2. Maximum fuel level

3. Wipe up any spilled fuel immediately. **NOTICE: Immediately wipe off spilled fuel with a clean, dry, soft cloth, since fuel may deteriorate painted surfaces or plastic parts.** [ECA10072]
4. Be sure to securely close the fuel tank cap.

EWA15152

⚠ WARNING _____

Gasoline is poisonous and can cause injury or death. Handle gasoline with care. Never siphon gasoline by mouth. If you should swallow some gasoline or inhale a lot of gasoline vapor, or get some gasoline in your eyes, see your doctor immedi-

ately. If gasoline spills on your skin, wash with soap and water. If gasoline spills on your clothing, change your clothes.

EAU58110

Recommended fuel:

Premium unleaded gasoline (Gasohol (E10) acceptable)

Fuel tank capacity:

14 L (3.70 US gal, 3.08 Imp.gal)

Fuel reserve amount:

2.7 L (0.71 US gal, 0.59 Imp.gal)

ECA11401

NOTICE

Use only unleaded gasoline. The use of leaded gasoline will cause severe damage to internal engine parts, such as the valves and piston rings, as well as to the exhaust system.

Your Yamaha engine has been designed to use premium unleaded gasoline with a research octane number of 95 or higher. If knocking (or pinging) occurs, use a gasoline of a different

brand. Use of unleaded fuel will extend spark plug life and reduce maintenance costs.

Gasohol

There are two types of gasohol: gasohol containing ethanol and that containing methanol. Gasohol containing ethanol can be used if the ethanol content does not exceed 10% (E10). Gasohol containing methanol is not recommended by Yamaha because it can cause damage to the fuel system or vehicle performance problems.

Fuel tank breather hose and overflow hose

EAU55512

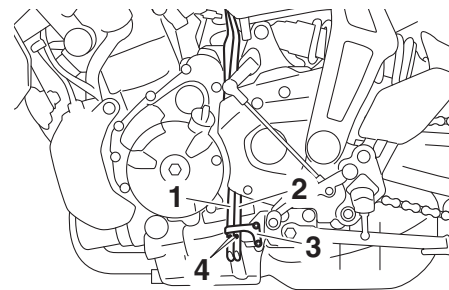

1. Fuel tank overflow hose
2. Fuel tank breather hose
3. Clamp
4. Original position (paint mark)

Before operating the motorcycle:

- Check each hose connection.
- Check each hose for cracks or damage, and replace if necessary.
- Make sure that the end of each hose is not blocked, and clean if necessary.
- Make sure that each hose is routed through the clamp.
- Make sure that the paint mark on each hose is below the clamp.

INSTRUMENT AND CONTROL FUNCTIONS

Catalytic converter

EAU13434

This model is equipped with a catalytic converter in the exhaust system.

EWA10863

⚠ WARNING

3

The exhaust system is hot after operation. To prevent a fire hazard or burns:

- Do not park the vehicle near possible fire hazards such as grass or other materials that easily burn.
- Park the vehicle in a place where pedestrians or children are not likely to touch the hot exhaust system.
- Make sure that the exhaust system has cooled down before doing any maintenance work.
- Do not allow the engine to idle more than a few minutes. Long idling can cause a build-up of heat.

NOTICE

ECA10702

Use only unleaded gasoline. The use of leaded gasoline will cause unreparable damage to the catalytic converter.

Seats

EAU59901

Passenger seat

To remove the passenger seat

1. Insert the key into the seat lock, and then turn it counterclockwise.

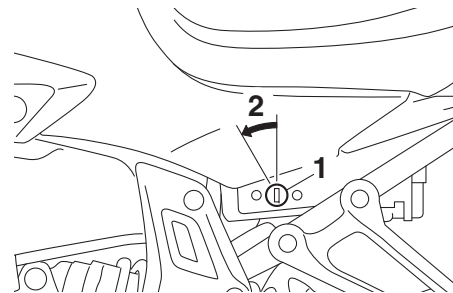

1. Seat lock
2. Unlock.

2. While holding the key in that position, lift the rear of the passenger seat and pull it backward.

INSTRUMENT AND CONTROL FUNCTIONS

To install the passenger seat

1. Insert the projections on the front of the passenger seat into the seat holders as shown, and then push the rear of the seat down to lock it in place.

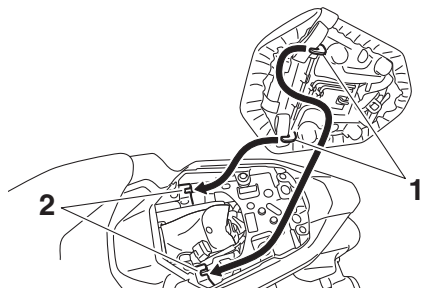

1. Projection
2. Seat holder

2. Remove the key.

Rider seat

To remove the rider seat

1. Remove the passenger seat, and then remove the hexagon wrench located on the bottom of the seat.

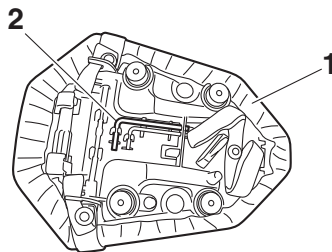

1. Passenger seat
2. Hexagon wrench

2. Pull up the corners on the rear of the rider seat as shown and remove the bolts with the hexagon wrench.

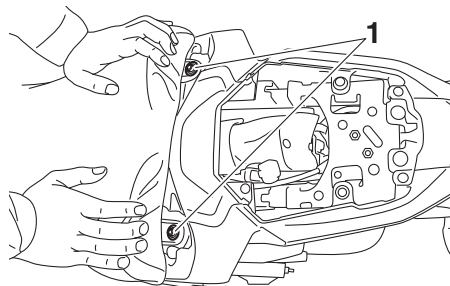

1. Bolt

3. Lift the seat rearward and up to remove it.

To install the rider seat

1. Fit the slot in the seat onto the projection on the frame cross member as shown, and then place the seat in the original position.

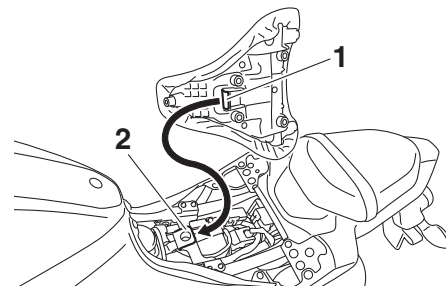

1. Slot
2. Projection

2. Install the bolts with the hexagon wrench.
3. Insert the hexagon wrench back into its holder on the passenger seat.
4. Install the passenger seat.

TIP

Make sure that the seats are properly secured before riding.

INSTRUMENT AND CONTROL FUNCTIONS

EAU59981

Helmet holding cable

A helmet holding cable is located on the bottom of the passenger seat. Use this cable in conjunction with the screwdriver to secure a helmet to the vehicle.

3

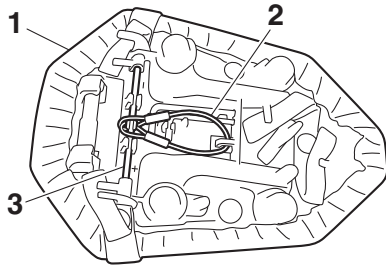

1. Passenger seat
2. Helmet holding cable
3. Screwdriver

To secure a helmet with the helmet holding cable

1. Remove the passenger seat. (See page 3-19.)
2. Remove the screwdriver from its holders on the passenger seat, and then remove the helmet holding cable from the screwdriver.

TIP

When removing the screwdriver, slide the screwdriver toward the “+” mark on the passenger seat.

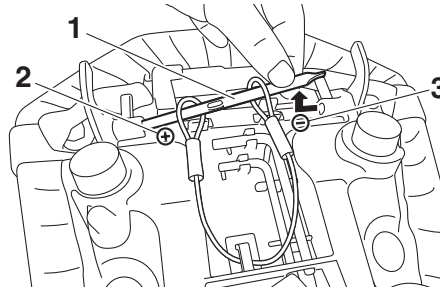

1. Screwdriver
2. “+” mark
3. “-” mark

3. Pass the helmet holding cable through the buckle on the helmet strap.
4. Hook the cable loops over the screwdriver, install the screwdriver by first inserting the screwdriver into the holder with the “+” mark, and then slide the screwdriver toward the holder with the “-” mark.

TIP

Make sure that the screwdriver is securely positioned between its holders, and then position the cable loops toward the middle of the screwdriver before installing the passenger seat.

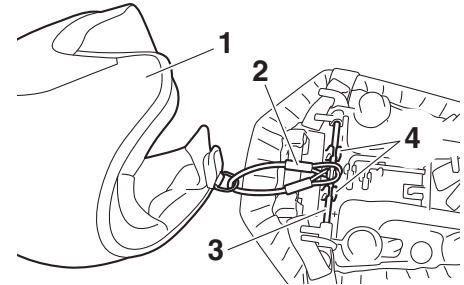

1. Helmet
2. Helmet holding cable
3. Screwdriver
4. Holder

5. Install the passenger seat.

WARNING! Never ride with a helmet attached to the helmet holder, since the helmet may hit objects, causing loss of control and possibly an accident. [EWA10162]

INSTRUMENT AND CONTROL FUNCTIONS

To release a helmet from the helmet holding cable

1. Remove the passenger seat.
2. Remove the screwdriver, then remove the helmet holding cable from the helmet.
3. Store the cable under the seat by hooking the cable loops over the screwdriver, install the screwdriver in its original position, and then hook the helmet holding cable over the hook on the bottom of the passenger seat.

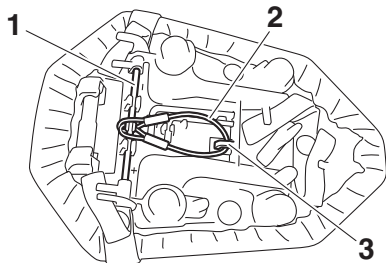

1. Screwdriver
2. Helmet holding cable
3. Hook
4. Install the passenger seat.

Storage compartment

EAU14465

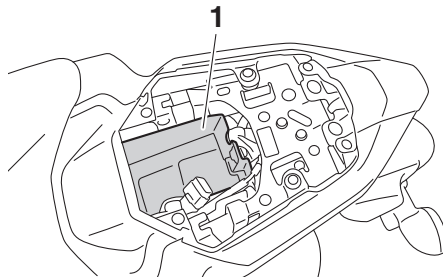

1. Storage compartment

The storage compartment is located under the passenger seat. (See page 3-19.)

When storing documents or other items in the storage compartment, be sure to wrap them in a plastic bag so that they will not get wet. When washing the vehicle, be careful not to let any water enter the storage compartment.

EWA10962

! WARNING

- Do not exceed the load limit of 1.5 kg (3 lb) for the storage compartment.

- Do not exceed the maximum load of MT07 176 kg (388 lb) MT07A 173 kg (381 lb) for the vehicle.

INSTRUMENT AND CONTROL FUNCTIONS

3

Adjusting the shock absorber assembly

EAU47001

This shock absorber assembly is equipped with a spring preload adjusting ring.

ECA10102

NOTICE

To avoid damaging the mechanism, do not attempt to turn beyond the maximum or minimum settings.

Adjust the spring preload as follows. To increase the spring preload and thereby harden the suspension, turn the adjusting ring in direction (a). To decrease the spring preload and thereby soften the suspension, turn the adjusting ring in direction (b).

- Align the appropriate notch in the adjusting ring with the position indicator on the shock absorber.
- Use the special wrench and extension bar included in the owner's tool kit to make the adjustment.

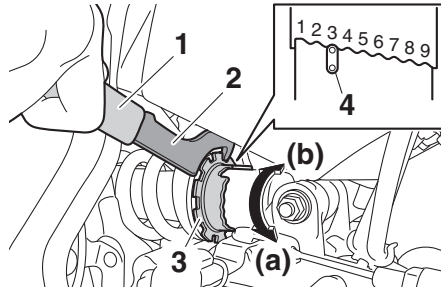

1. Extension bar
2. Special wrench
3. Spring preload adjusting ring
4. Position indicator

Spring preload setting:

- Minimum (soft):
1
- Standard:
3
- Maximum (hard):
9

EWA10222

WARNING

This shock absorber assembly contains highly pressurized nitrogen gas. Read and understand the following information before handling the shock absorber assembly.

- Do not tamper with or attempt to open the cylinder assembly.
- Do not subject the shock absorber assembly to an open flame or other high heat source. This may cause the unit to explode due to excessive gas pressure.
- Do not deform or damage the cylinder in any way. Cylinder damage will result in poor damping performance.
- Do not dispose of a damaged or worn-out shock absorber assembly yourself. Take the shock absorber assembly to a Yamaha dealer for any service.

Luggage strap holders

EAU38963

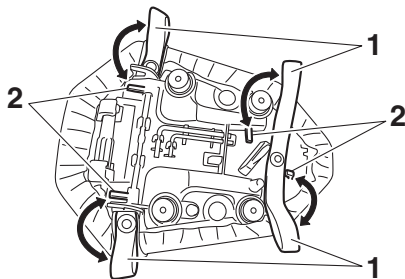

1. Luggage strap holder
2. Hook

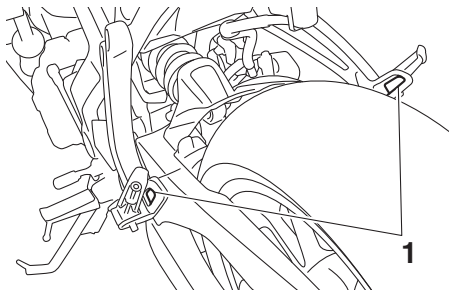

1. Luggage strap holder

There are six luggage strap holders, four on the bottom of the passenger seat and one on each passenger footrest. To use the luggage strap holders

on the passenger seat, remove the passenger seat. (See page 3-19.) Unhook the straps from the hooks, and then install the seat with the straps hanging out from under the passenger seat.

Sidestand

EAU15306

The sidestand is located on the left side of the frame. Raise the sidestand or lower it with your foot while holding the vehicle upright.

TIP

The built-in sidestand switch is part of the ignition circuit cut-off system, which cuts the ignition in certain situations. (See the following section for an explanation of the ignition circuit cut-off system.)

EWA10242

⚠ WARNING

The vehicle must not be ridden with the sidestand down, or if the sidestand cannot be properly moved up (or does not stay up), otherwise the sidestand could contact the ground and distract the operator, resulting in a possible loss of control. Yamaha's ignition circuit cut-off system has been designed to assist the operator in fulfilling the responsibility of raising the sidestand before starting off. Therefore, check

INSTRUMENT AND CONTROL FUNCTIONS

this system regularly and have a Yamaha dealer repair it if it does not function properly.

3

EAU57950

Ignition circuit cut-off system

The ignition circuit cut-off system (comprising the sidestand switch, clutch switch and neutral switch) has the following functions.

- It prevents starting when the transmission is in gear and the sidestand is up, but the clutch lever is not pulled.
- It prevents starting when the transmission is in gear and the clutch lever is pulled, but the sidestand is still down.
- It cuts the running engine when the transmission is in gear and the sidestand is moved down.

Periodically check the operation of the ignition circuit cut-off system according to the following procedure.

INSTRUMENT AND CONTROL FUNCTIONS

With the engine turned off:

1. Move the sidestand down.
2. Make sure that the start/engine stop switch is set to “○”.
3. Turn the key on.
4. Shift the transmission into the neutral position.
5. Push the “⊕” side of the start/engine stop switch.

Does the engine start?

YES

NO

With the engine still running:

6. Move the sidestand up.
7. Keep the clutch lever pulled.
8. Shift the transmission into gear.
9. Move the sidestand down.

Does the engine stall?

YES

NO

After the engine has stalled:

10. Move the sidestand up.
11. Keep the clutch lever pulled.
12. Push the “⊕” side of the start/engine stop switch.

Does the engine start?

YES

NO

The system is OK. **The motorcycle can be ridden.**



WARNING

If a malfunction is noted, have a Yamaha dealer check the system before riding.

The neutral switch may not be working correctly.
The motorcycle should not be ridden until checked by a Yamaha dealer.

The sidestand switch may not be working correctly.
The motorcycle should not be ridden until checked by a Yamaha dealer.

The clutch switch may not be working correctly.
The motorcycle should not be ridden until checked by a Yamaha dealer.

INSTRUMENT AND CONTROL FUNCTIONS

Auxiliary DC connector

EAU59950

This vehicle is equipped with an auxiliary DC connector. A 12-V accessory connected to the auxiliary DC connector can be used when the key is in the "ON" position.

EWA12532

⚠ WARNING

To prevent electrical shock or short-circuiting, make sure that the cap is installed when the auxiliary DC connector is not being used.

3

ECA20090

NOTICE

The accessory connected to the auxiliary DC connector should not be used with the engine turned off, and the load must never exceed 24 W (2 A), otherwise the fuse may blow or the battery may discharge.

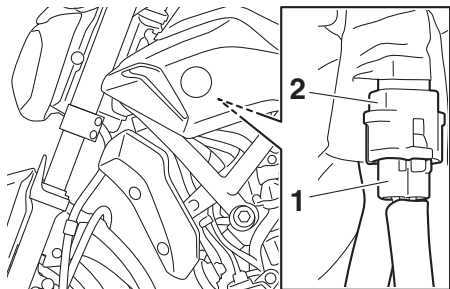

1. Auxiliary DC connector
2. Auxiliary DC connector cap

FOR YOUR SAFETY – PRE-OPERATION CHECKS

EAU15598

Inspect your vehicle each time you use it to make sure the vehicle is in safe operating condition. Always follow the inspection and maintenance procedures and schedules described in the Owner's Manual.

EWA11152

WARNING

Failure to inspect or maintain the vehicle properly increases the possibility of an accident or equipment damage. Do not operate the vehicle if you find any problem. If a problem cannot be corrected by the procedures provided in this manual, have the vehicle inspected by a Yamaha dealer.

4

Before using this vehicle, check the following points:

ITEM	CHECKS	PAGE
Fuel	<ul style="list-style-type: none">• Check fuel level in fuel tank.• Refuel if necessary.• Check fuel line for leakage.• Check fuel tank breather hose and overflow hose for obstructions, cracks or damage, and check hose connections.	3-17, 3-18
Engine oil	<ul style="list-style-type: none">• Check oil level in engine.• If necessary, add recommended oil to specified level.• Check vehicle for oil leakage.	6-9
Coolant	<ul style="list-style-type: none">• Check coolant level in reservoir.• If necessary, add recommended coolant to specified level.• Check cooling system for leakage.	6-11
Front brake	<ul style="list-style-type: none">• Check operation.• If soft or spongy, have Yamaha dealer bleed hydraulic system.• Check brake pads for wear.• Replace if necessary.• Check fluid level in reservoir.• If necessary, add specified brake fluid to specified level.• Check hydraulic system for leakage.	6-20, 6-21

FOR YOUR SAFETY – PRE-OPERATION CHECKS

ITEM	CHECKS	PAGE
Rear brake	<ul style="list-style-type: none"> • Check operation. • If soft or spongy, have Yamaha dealer bleed hydraulic system. • Check brake pads for wear. • Replace if necessary. • Check fluid level in reservoir. • If necessary, add specified brake fluid to specified level. • Check hydraulic system for leakage. 	6-20, 6-21
Clutch	<ul style="list-style-type: none"> • Check operation. • Lubricate cable if necessary. • Check lever free play. • Adjust if necessary. 	6-18
Throttle grip	<ul style="list-style-type: none"> • Make sure that operation is smooth. • Check throttle grip free play. • If necessary, have Yamaha dealer adjust throttle grip free play and lubricate cable and grip housing. 	6-15, 6-25
Control cables	<ul style="list-style-type: none"> • Make sure that operation is smooth. • Lubricate if necessary. 	6-25
Drive chain	<ul style="list-style-type: none"> • Check chain slack. • Adjust if necessary. • Check chain condition. • Lubricate if necessary. 	6-22, 6-24
Wheels and tires	<ul style="list-style-type: none"> • Check for damage. • Check tire condition and tread depth. • Check air pressure. • Correct if necessary. 	6-15, 6-18
Brake and shift pedals	<ul style="list-style-type: none"> • Make sure that operation is smooth. • Lubricate pedal pivoting points if necessary. 	6-25
Brake and clutch levers	<ul style="list-style-type: none"> • Make sure that operation is smooth. • Lubricate lever pivoting points if necessary. 	6-26
Sidestand	<ul style="list-style-type: none"> • Make sure that operation is smooth. • Lubricate pivot if necessary. 	6-27

FOR YOUR SAFETY – PRE-OPERATION CHECKS

ITEM	CHECKS	PAGE
Chassis fasteners	<ul style="list-style-type: none">• Make sure that all nuts, bolts and screws are properly tightened.• Tighten if necessary.	—
Instruments, lights, signals and switches	<ul style="list-style-type: none">• Check operation.• Correct if necessary.	—
Sidestand switch	<ul style="list-style-type: none">• Check operation of ignition circuit cut-off system.• If system is not working correctly, have Yamaha dealer check vehicle.	3-24

OPERATION AND IMPORTANT RIDING POINTS

EAU15952

EAU48711

EAU59851

Read the Owner's Manual carefully to become familiar with all controls. If there is a control or function you do not understand, ask your Yamaha dealer.

EWA10272

WARNING

Failure to familiarize yourself with the controls can lead to loss of control, which could cause an accident or injury.

5

TIP

This model is equipped with:

- a lean angle sensor to stop the engine in case of a turnover. In this case, the multi-function display indicates error code 30, but this is not a malfunction. Turn the key to "OFF" and then to "ON" to clear the error code. Failing to do so will prevent the engine from starting even though the engine will crank when pushing the start switch.
- an engine auto-stop system. The engine stops automatically if left idling for 20 minutes. If the engine stops, simply push the start switch to restart the engine.

Starting the engine

In order for the ignition circuit cut-off system to enable starting, one of the following conditions must be met:

- The transmission is in the neutral position.
- The transmission is in gear with the clutch lever pulled and the sidestand up.

See page 3-25 for more information.

1. Turn the key to "ON" and make sure that the start/engine stop switch is set to "○".

The following warning lights and indicator light should come on for a few seconds, then go off.

- Coolant temperature warning light
- Engine trouble warning light
- Immobilizer system indicator light
- Oil pressure warning light (This warning light comes on again after going off briefly, and then remains on until the engine is started.)

OPERATION AND IMPORTANT RIDING POINTS

ECA20790

NOTICE

- If the above warning or indicator lights do not come on initially when the key is turned to “ON”, or if a warning or indicator light (except the oil pressure warning light) remains on, see page 3-3 for the corresponding warning and indicator light circuit check.
- After going off once, the oil pressure warning light will come back on until the engine is started. If the warning light does not come on, or if the warning light does not go off after starting the engine, see page 3-3 for the engine oil pressure warning light circuit check.

For ABS models:

The ABS warning light should come on when the key is turned to “ON”, and then go off after traveling at a speed of 10 km/h (6 mi/h) or higher.

ECA17682

NOTICE

If the ABS warning light does not come on and then go off as explained above, see page 3-3 for the warning light circuit check.

2. Shift the transmission into the neutral position. The neutral indicator light should come on. If not, ask a Yamaha dealer to check the electrical circuit.
3. Start the engine by pushing the “(⊖)” side of the start/engine stop switch.

If the engine fails to start, release the start/engine stop switch, wait a few seconds, and then try again. Each starting attempt should be as short as possible to preserve the battery. Do not crank the engine more than 10 seconds on any one attempt.

ECA11043

NOTICE

For maximum engine life, never accelerate hard when the engine is cold!

EAU16672

Shifting

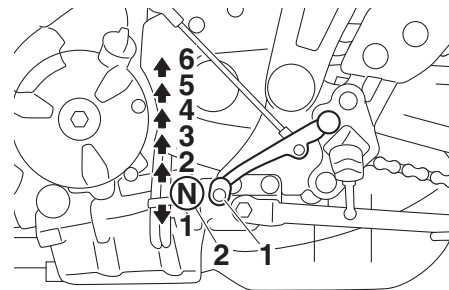

1. Shift pedal
2. Neutral position

Shifting gears lets you control the amount of engine power available for starting off, accelerating, climbing hills, etc.

The gear positions are shown in the illustration.

TIP

To shift the transmission into the neutral position, press the shift pedal down repeatedly until it reaches the end of its travel, and then slightly raise it.

OPERATION AND IMPORTANT RIDING POINTS

NOTICE

ECA10261

- Even with the transmission in the neutral position, do not coast for long periods of time with the engine off, and do not tow the motorcycle for long distances. The transmission is properly lubricated only when the engine is running. Inadequate lubrication may damage the transmission.
 - Always use the clutch while changing gears to avoid damaging the engine, transmission, and drive train, which are not designed to withstand the shock of forced shifting.
-

Tips for reducing fuel consumption

EAU16811

Fuel consumption depends largely on your riding style. Consider the following tips to reduce fuel consumption:

- Shift up swiftly, and avoid high engine speeds during acceleration.
- Do not rev the engine while shifting down, and avoid high engine speeds with no load on the engine.
- Turn the engine off instead of letting it idle for an extended length of time (e.g., in traffic jams, at traffic lights or at railroad crossings).

Engine break-in

EAU16842

There is never a more important period in the life of your engine than the period between 0 and 1600 km (1000 mi). For this reason, you should read the following material carefully.

Since the engine is brand new, do not put an excessive load on it for the first 1600 km (1000 mi). The various parts in the engine wear and polish themselves to the correct operating clearances. During this period, prolonged full-throttle operation or any condition that might result in engine overheating must be avoided.

EAU17094

0–1000 km (0–600 mi)

Avoid prolonged operation above 5000 r/min. **NOTICE: After 1000 km (600 mi) of operation, the engine oil must be changed and the oil filter cartridge or element replaced.** [ECA10303]

1000–1600 km (600–1000 mi)

Avoid prolonged operation above 6000 r/min.

OPERATION AND IMPORTANT RIDING POINTS

1600 km (1000 mi) and beyond

The vehicle can now be operated normally.

ECA10311

NOTICE

- Keep the engine speed out of the tachometer red zone.
 - If any engine trouble should occur during the engine break-in period, immediately have a Yamaha dealer check the vehicle.
-

EAU17214

Parking

When parking, stop the engine, and then remove the key from the main switch.

EWA10312

⚠ WARNING

- Since the engine and exhaust system can become very hot, park in a place where pedestrians or children are not likely to touch them and be burned.
 - Do not park on a slope or on soft ground, otherwise the vehicle may overturn, increasing the risk of a fuel leak and fire.
 - Do not park near grass or other flammable materials which might catch fire.
-

PERIODIC MAINTENANCE AND ADJUSTMENT

EAU17245

EWA15123

EAU17303

Periodic inspection, adjustment, and lubrication will keep your vehicle in the safest and most efficient condition possible. Safety is an obligation of the vehicle owner/operator. The most important points of vehicle inspection, adjustment, and lubrication are explained on the following pages.

The intervals given in the periodic maintenance charts should be simply considered as a general guide under normal riding conditions. However, depending on the weather, terrain, geographical location, and individual use, the maintenance intervals may need to be shortened.

WARNING

EWA10322

Failure to properly maintain the vehicle or performing maintenance activities incorrectly may increase your risk of injury or death during service or while using the vehicle. If you are not familiar with vehicle service, have a Yamaha dealer perform service.

WARNING

Turn off the engine when performing maintenance unless otherwise specified.

- **A running engine has moving parts that can catch on body parts or clothing and electrical parts that can cause shocks or fires.**
 - **Running the engine while servicing can lead to eye injury, burns, fire, or carbon monoxide poisoning – possibly leading to death. See page 1-3 for more information about carbon monoxide.**
-

WARNING

EWA15461

Brake discs, calipers, drums, and linings can become very hot during use. To avoid possible burns, let brake components cool before touching them.

Emission controls not only function to ensure cleaner air, but are also vital to proper engine operation and maximum performance. In the following periodic maintenance charts, the services related to emissions control are grouped separately. These services require specialized data, knowledge, and equipment. Maintenance, replacement, or repair of the emission control devices and systems may be performed by any repair establishment or individual that is certified (if applicable). Yamaha dealers are trained and equipped to perform these particular services.

PERIODIC MAINTENANCE AND ADJUSTMENT

Owner's tool kit

EAU59910

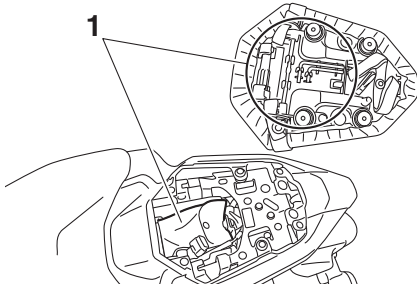

1. Owner's tool kit

The owner's tool kit is located under the passenger seat. Some tools are also located on the bottom of the passenger seat. (See page 3-19.)

The service information included in this manual and the tools provided in the owner's tool kit are intended to assist you in the performance of preventive maintenance and minor repairs. However, additional tools such as a torque wrench may be necessary to perform certain maintenance work correctly.

TIP _____

If you do not have the tools or experience required for a particular job, have a Yamaha dealer perform it for you.

PERIODIC MAINTENANCE AND ADJUSTMENT

EAU46862

TIP

- The annual checks must be performed every year, except if a kilometer-based maintenance, or for the UK, a mileage-based maintenance, is performed instead.
- From 50000 km (30000 mi), repeat the maintenance intervals starting from 10000 km (6000 mi).
- Items marked with an asterisk should be performed by a Yamaha dealer as they require special tools, data and technical skills.

EAU46911

Periodic maintenance chart for the emission control system

NO.	ITEM	CHECK OR MAINTENANCE JOB	ODOMETER READING					ANNUAL CHECK
			1000 km (600 mi)	10000 km (6000 mi)	20000 km (12000 mi)	30000 km (18000 mi)	40000 km (24000 mi)	
1	* Fuel line	<ul style="list-style-type: none"> • Check fuel hoses for cracks or damage. 		√	√	√	√	√
2	* Spark plugs	<ul style="list-style-type: none"> • Check condition. • Clean and regap. 		√		√		
		<ul style="list-style-type: none"> • Replace. 			√		√	
3	* Valves	<ul style="list-style-type: none"> • Check valve clearance. • Adjust. 	Every 40000 km (24000 mi)					
4	* Fuel injection system	<ul style="list-style-type: none"> • Adjust synchronization. 	√	√	√	√	√	√

PERIODIC MAINTENANCE AND ADJUSTMENT

EAU1770K

General maintenance and lubrication chart

NO.	ITEM	CHECK OR MAINTENANCE JOB	ODOMETER READING					ANNUAL CHECK
			1000 km (600 mi)	10000 km (6000 mi)	20000 km (12000 mi)	30000 km (18000 mi)	40000 km (24000 mi)	
1	* Air filter element	• Replace.					√	
2	Air filter check hose	• Clean.	√	√	√	√	√	
3	Clutch	• Check operation. • Adjust.	√	√	√	√	√	
4	* Front brake	• Check operation, fluid level and vehicle for fluid leakage.	√	√	√	√	√	√
		• Replace brake pads.	Whenever worn to the limit					
5	* Rear brake	• Check operation, fluid level and vehicle for fluid leakage.	√	√	√	√	√	√
		• Replace brake pads.	Whenever worn to the limit					
6	* Brake hoses	• Check for cracks or damage. • Check for correct routing and clamping.		√	√	√	√	√
		• Replace.	Every 4 years					
7	* Brake fluid	• Replace.	Every 2 years					
8	* Wheels	• Check runout and for damage.		√	√	√	√	
9	* Tires	• Check tread depth and for damage. • Replace if necessary. • Check air pressure. • Correct if necessary.		√	√	√	√	√
10	* Wheel bearings	• Check bearings for looseness or damage.		√	√	√	√	

6

PERIODIC MAINTENANCE AND ADJUSTMENT

NO.	ITEM	CHECK OR MAINTENANCE JOB	ODOMETER READING					ANNUAL CHECK
			1000 km (600 mi)	10000 km (6000 mi)	20000 km (12000 mi)	30000 km (18000 mi)	40000 km (24000 mi)	
11	* Swingarm	• Check operation and for excessive play.		√	√	√	√	
		• Lubricate with lithium-soap-based grease.	Every 50000 km (30000 mi)					
12	Drive chain	<ul style="list-style-type: none"> • Check chain slack, alignment and condition. • Adjust and lubricate chain with a special O-ring chain lubricant thoroughly. 	Every 800 km (500 mi) and after washing the motorcycle, riding in the rain or riding in wet areas					
13	* Steering bearings	• Check bearing play and steering for roughness.	√	√	√	√	√	
		• Lubricate with lithium-soap-based grease.	Every 20000 km (12000 mi)					
14	* Chassis fasteners	• Make sure that all nuts, bolts and screws are properly tightened.		√	√	√	√	√
15	Brake lever pivot shaft	• Lubricate with silicone grease.		√	√	√	√	√
16	Brake pedal pivot shaft	• Lubricate with lithium-soap-based grease.		√	√	√	√	√
17	Clutch lever pivot shaft	• Lubricate with lithium-soap-based grease.		√	√	√	√	√
18	Shift pedal pivot shaft	• Lubricate with lithium-soap-based grease.		√	√	√	√	√
19	Sidestand	<ul style="list-style-type: none"> • Check operation. • Lubricate with lithium-soap-based grease. 		√	√	√	√	√
20	* Sidestand switch	• Check operation.	√	√	√	√	√	√

PERIODIC MAINTENANCE AND ADJUSTMENT

NO.	ITEM	CHECK OR MAINTENANCE JOB	ODOMETER READING					ANNUAL CHECK
			1000 km (600 mi)	10000 km (6000 mi)	20000 km (12000 mi)	30000 km (18000 mi)	40000 km (24000 mi)	
21	* Front fork	<ul style="list-style-type: none"> • Check operation and for oil leakage. 		√	√	√	√	
22	* Shock absorber assembly	<ul style="list-style-type: none"> • Check operation and shock absorber for oil leakage. 		√	√	√	√	
23	* Rear suspension relay arm and connecting arm pivoting points	<ul style="list-style-type: none"> • Check operation. 		√	√	√	√	
		<ul style="list-style-type: none"> • Lubricate with lithium-soap-based grease. 			√		√	
24	Engine oil	<ul style="list-style-type: none"> • Change. • Check oil level and vehicle for oil leakage. 	√	√	√	√	√	√
25	Engine oil filter cartridge	<ul style="list-style-type: none"> • Replace. 	√		√		√	
26	* Cooling system	<ul style="list-style-type: none"> • Check coolant level and vehicle for coolant leakage. 		√	√	√	√	√
		<ul style="list-style-type: none"> • Change coolant. 	Every 3 years					
27	* Front and rear brake switches	<ul style="list-style-type: none"> • Check operation. 	√	√	√	√	√	√
28	Moving parts and cables	<ul style="list-style-type: none"> • Lubricate. 		√	√	√	√	√
29	* Throttle grip	<ul style="list-style-type: none"> • Check operation. • Check throttle grip free play, and adjust if necessary. • Lubricate cable and grip housing. 		√	√	√	√	√
30	* Lights, signals and switches	<ul style="list-style-type: none"> • Check operation. • Adjust headlight beam. 	√	√	√	√	√	√

PERIODIC MAINTENANCE AND ADJUSTMENT

EAU18681

TIP

- Air filter
 - This model's air filter is equipped with a disposable oil-coated paper element, which must not be cleaned with compressed air to avoid damaging it.
 - The air filter element needs to be replaced more frequently when riding in unusually wet or dusty areas.
 - Hydraulic brake service
 - Regularly check and, if necessary, correct the brake fluid level.
 - Every two years replace the internal components of the brake master cylinders and calipers, and change the brake fluid.
 - Replace the brake hoses every four years and if cracked or damaged.
-

PERIODIC MAINTENANCE AND ADJUSTMENT

Checking the spark plugs

EAU19653

The spark plugs are important engine components, which should be checked periodically, preferably by a Yamaha dealer. Since heat and deposits will cause any spark plug to slowly erode, they should be removed and checked in accordance with the periodic maintenance and lubrication chart. In addition, the condition of the spark plugs can reveal the condition of the engine.

The porcelain insulator around the center electrode of each spark plug should be a medium-to-light tan (the ideal color when the vehicle is ridden normally), and all spark plugs installed in the engine should have the same color. If any spark plug shows a distinctly different color, the engine could be operating improperly. Do not attempt to diagnose such problems yourself. Instead, have a Yamaha dealer check the vehicle.

If a spark plug shows signs of electrode erosion and excessive carbon or other deposits, it should be replaced.

Specified spark plug:
NGK/LMAR8A-9

Before installing a spark plug, the spark plug gap should be measured with a wire thickness gauge and, if necessary, adjusted to specification.

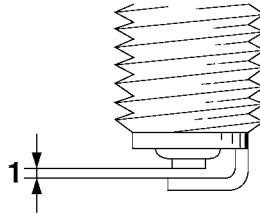

1. Spark plug gap

Spark plug gap:
0.8–0.9 mm (0.031–0.035 in)

Clean the surface of the spark plug gasket and its mating surface, and then wipe off any grime from the spark plug threads.

Tightening torque:
Spark plug:
13 Nm (1.3 m·kgf, 9.4 ft·lbf)

TIP

If a torque wrench is not available when installing a spark plug, a good estimate of the correct torque is 1/4–1/2 turn past finger tight. However, the spark plug should be tightened to the specified torque as soon as possible.

ECA10841

NOTICE

Do not use any tools to remove or install the spark plug cap, otherwise the ignition coil coupler may get damaged. The spark plug cap may be difficult to remove because the rubber seal on the end of the cap fits tightly. To remove the spark plug cap, simply twist it back and forth while pulling it out; to install it, twist it back and forth while pushing it in.

PERIODIC MAINTENANCE AND ADJUSTMENT

EAU60470

Engine oil and oil filter cartridge

The engine oil level should be checked before each ride. In addition, the oil must be changed and the oil filter cartridge replaced at the intervals specified in the periodic maintenance and lubrication chart.

To check the engine oil level

1. Place the vehicle on a level surface and hold it in an upright position. A slight tilt to the side can result in a false reading.
2. Start the engine, warm it up for several minutes, and then turn it off.
3. Wait a few minutes until the oil settles, and then check the oil level through the engine oil level check window located at the bottom-left side of the crankcase.

TIP

The engine oil should be between the minimum and maximum level marks.

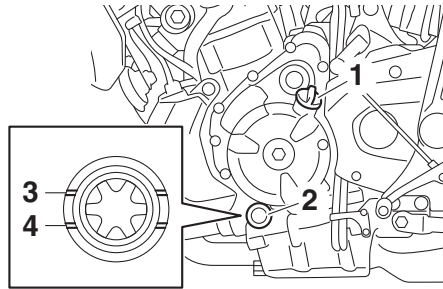

1. Engine oil filler cap
2. Engine oil level check window
3. Maximum level mark
4. Minimum level mark

4. If the engine oil is below the minimum level mark, add sufficient oil of the recommended type to raise it to the correct level.

To change the engine oil (with or without oil filter cartridge replacement)

1. Place the vehicle on a level surface.
2. Start the engine, warm it up for several minutes, and then turn it off.
3. Place an oil pan under the engine to collect the used oil.

4. Remove the engine oil filler cap, the engine oil drain bolt and its gasket to drain the oil from the crankcase.

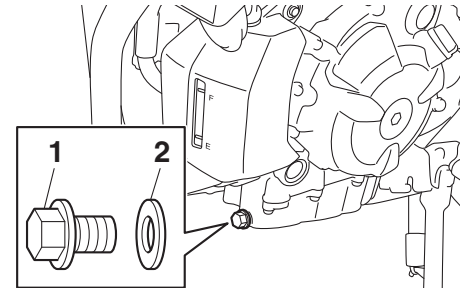

1. Engine oil drain bolt
2. Gasket

TIP

Skip steps 5–7 if the oil filter cartridge is not being replaced.

5. Remove the oil filter cartridge with an oil filter wrench.

PERIODIC MAINTENANCE AND ADJUSTMENT

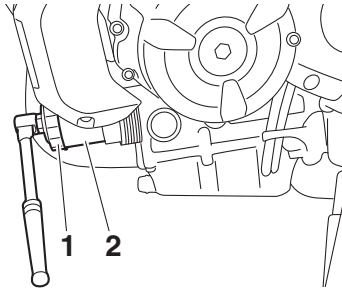

1. Oil filter wrench
2. Oil filter cartridge

TIP _____
An oil filter wrench is available at a Yamaha dealer.

6. Apply a thin coat of clean engine oil to the O-ring of the new oil filter cartridge.

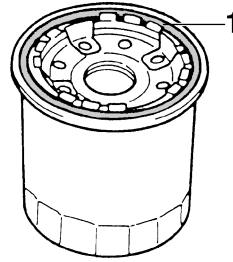

1. O-ring

TIP _____
Make sure that the O-ring is properly seated.

7. Install the new oil filter cartridge with an oil filter wrench, and then tighten it to the specified torque with a torque wrench.

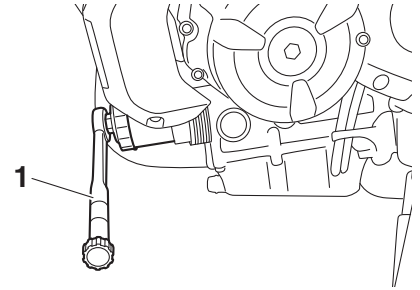

1. Torque wrench

Tightening torque:
Oil filter cartridge:
17 Nm (1.7 m·kgf, 12 ft·lbf)

8. Install the engine oil drain bolt and its new gasket, and then tighten the bolt to the specified torque.

Tightening torque:
Engine oil drain bolt:
43 Nm (4.3 m·kgf, 31 ft·lbf)

9. Refill with the specified amount of the recommended engine oil, and then install and tighten the oil filler cap.

PERIODIC MAINTENANCE AND ADJUSTMENT

Recommended engine oil:

See page 8-1.

Oil quantity:

Without oil filter cartridge replacement:

2.30 L (2.43 US qt, 2.02 Imp.qt)

With oil filter cartridge replacement:

2.60 L (2.75 US qt, 2.29 Imp.qt)

TIP

Be sure to wipe off spilled oil on any parts after the engine and exhaust system have cooled down.

NOTICE

- In order to prevent clutch slippage (since the engine oil also lubricates the clutch), do not mix any chemical additives. Do not use oils with a diesel specification of "CD" or oils of a higher quality than specified. In addition, do not use oils labeled "ENERGY CONSERVING II" or higher.
- Make sure that no foreign material enters the crankcase.

10. Start the engine, and then let it idle for several minutes while checking it for oil leakage. If oil is leaking, immediately turn the engine off and check for the cause.

TIP

After the engine is started, the engine oil pressure warning light should go off.

NOTICE

If the oil pressure warning light flickers or remains on even if the oil level is correct, immediately turn the engine off and have a Yamaha dealer check the vehicle.

11. Turn the engine off, wait a few minutes until the oil settles, and then check the oil level and correct it if necessary.

Coolant

The coolant level should be checked before each ride. In addition, the coolant must be changed at the intervals specified in the periodic maintenance and lubrication chart.

To check the coolant level

1. Place the vehicle on a level surface and hold it in an upright position.

TIP

- The coolant level must be checked on a cold engine since the level varies with engine temperature.
- Make sure that the vehicle is positioned straight up when checking the coolant level. A slight tilt to the side can result in a false reading.

2. Check the coolant level in the coolant reservoir.

TIP

The coolant should be between the minimum and maximum level marks.

EAU20071

EAU20093

ECA20860

ECA11621

PERIODIC MAINTENANCE AND ADJUSTMENT

EAU59861

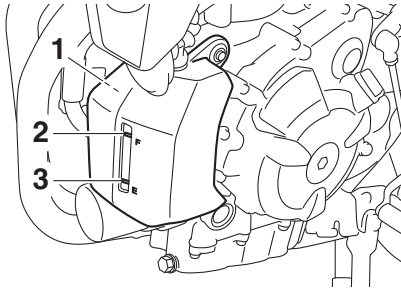

1. Coolant reservoir
2. Maximum level mark
3. Minimum level mark

3. If the coolant is at or below the minimum level mark, remove the reservoir cap.

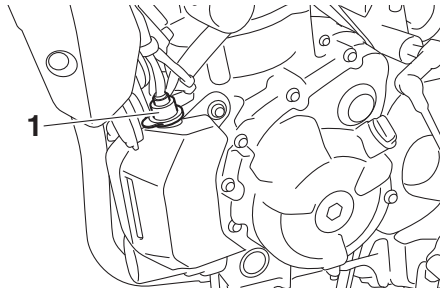

1. Coolant reservoir cap

4. Add coolant to the maximum level mark, and then install the reservoir cap. **WARNING! Remove only the coolant reservoir cap. Never attempt to remove the radiator cap when the engine is hot.**
[EWA15162] **NOTICE: If coolant is not available, use distilled water or soft tap water instead. Do not use hard water or salt water since it is harmful to the engine. If water has been used instead of coolant, replace it with coolant as soon as possible, otherwise the cooling system will not be protected against frost and corrosion. If water has been added to the coolant, have a Yamaha dealer check the anti-freeze content of the coolant as soon as possible, otherwise the effectiveness of the coolant will be reduced.**[ECA10473]

Coolant reservoir capacity (up to the maximum level mark):
0.25 L (0.26 US qt, 0.22 Imp.qt)

To change the coolant

1. Place the vehicle on a level surface and let the engine cool if necessary.
2. Place a container under the engine to collect the used coolant.
3. Remove the radiator cap retaining bolt and radiator cap. **WARNING! Never attempt to remove the radiator cap when the engine is hot.**[EWA10382]

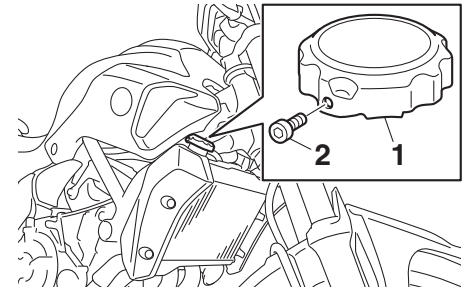

1. Radiator cap
2. Radiator cap retaining bolt

4. Remove the coolant reservoir cover by removing the bolt and quick fastener, and then remove the coolant reservoir.

PERIODIC MAINTENANCE AND ADJUSTMENT

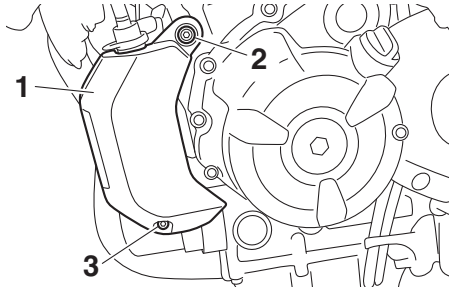

1. Coolant reservoir cover
2. Bolt
3. Quick fastener

6. Remove the coolant reservoir cap.

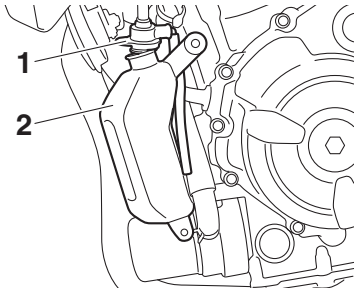

1. Coolant reservoir cap
2. Coolant reservoir

6. Drain the coolant from the coolant reservoir by turning it upside down.

7. Install the coolant reservoir and its cover by placing them in the original position, and then installing the bolt and quick fastener.

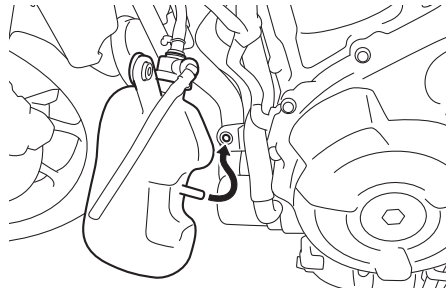

8. Remove the coolant drain bolt and its gasket to drain the cooling system.

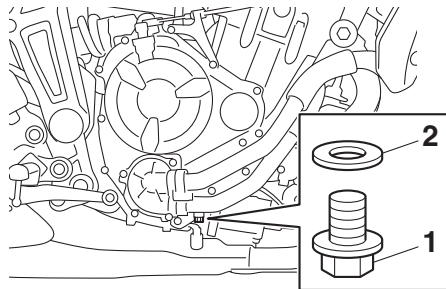

1. Coolant drain bolt
2. Gasket

9. After the coolant is completely drained, thoroughly flush the cooling system with clean tap water.
10. Install the coolant drain bolt and its new gasket, and then tighten the bolt to the specified torque.

Tightening torque:

Coolant drain bolt:
7 Nm (0.7 m·kgf, 5.1 ft·lbf)

11. Pour the specified amount of the recommended coolant into the radiator and reservoir.

Antifreeze/water mixture ratio:

1:1

Recommended antifreeze:

High-quality ethylene glycol antifreeze containing corrosion inhibitors for aluminum engines

Coolant quantity:

Radiator capacity (including all routes):

1.60 L (1.69 US qt, 1.41 Imp.qt)

Coolant reservoir capacity (up to the maximum level mark):

0.25 L (0.26 US qt, 0.22 Imp.qt)

12. Install the coolant reservoir cap.
13. Install the radiator cap.

PERIODIC MAINTENANCE AND ADJUSTMENT

14. Start the engine, let it idle for several minutes, and then turn it off.
15. Remove the radiator cap to check the coolant level in the radiator. If necessary, add sufficient coolant until it reaches the top of the radiator, and then install the radiator cap and radiator cap retaining bolt.
16. Check the coolant level in the reservoir. If necessary, remove the coolant reservoir cap, add coolant to the maximum level mark, and then install the cap.
17. Start the engine, and then check the vehicle for coolant leakage. If coolant is leaking, have a Yamaha dealer check the cooling system.

Replacing the air filter element and cleaning the check hose EAU60450

The air filter element should be replaced at the intervals specified in the periodic maintenance and lubrication chart. Have a Yamaha dealer replace the air filter element more frequently if you are riding in unusually wet or dusty areas. However, the air filter check hose can be easily reached and should be frequently checked and cleaned if necessary.

To clean the air filter check hose

1. Check the hose under the air filter case for accumulated dirt or water.

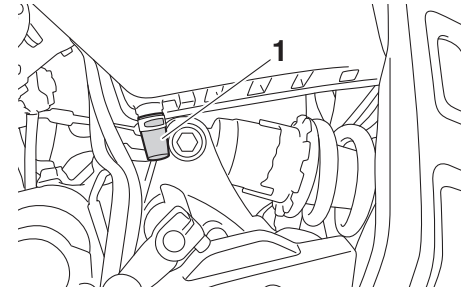

1. Air filter check hose

2. If dirt or water is visible, remove the hose, clean it, and then install it.

PERIODIC MAINTENANCE AND ADJUSTMENT

Checking the throttle grip free play

EAU21385

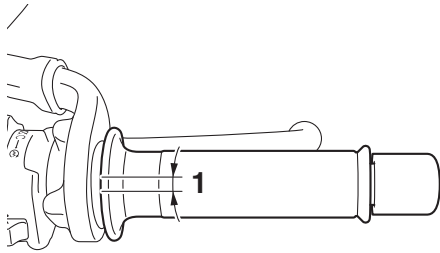

6

1. Throttle grip free play

The throttle grip free play should measure 3.0–5.0 mm (0.12–0.20 in) at the inner edge of the throttle grip. Periodically check the throttle grip free play and, if necessary, have a Yamaha dealer adjust it.

Valve clearance

EAU21402

The valve clearance changes with use, resulting in improper air-fuel mixture and/or engine noise. To prevent this from occurring, the valve clearance must be adjusted by a Yamaha dealer at the intervals specified in the periodic maintenance and lubrication chart.

Tires

EAU60460

Tires are the only contact between the vehicle and the road. Safety in all conditions of riding depends on a relatively small area of road contact. Therefore, it is essential to maintain the tires in good condition at all times and replace them at the appropriate time with the specified tires.

Tire air pressure

The tire air pressure should be checked and, if necessary, adjusted before each ride.

EWA10504

⚠ WARNING

Operation of this vehicle with improper tire pressure may cause severe injury or death from loss of control.

- The tire air pressure must be checked and adjusted on cold tires (i.e., when the temperature of the tires equals the ambient temperature).
- The tire air pressure must be adjusted in accordance with the riding speed and with the total

PERIODIC MAINTENANCE AND ADJUSTMENT

weight of rider, passenger, cargo, and accessories approved for this model.

Tire air pressure (measured on cold tires):

Front:
225 kPa (2.25 kgf/cm², 33 psi)

Rear:
250 kPa (2.50 kgf/cm², 36 psi)

High-speed riding:

Front:
225 kPa (2.25 kgf/cm², 33 psi)

Rear:
250 kPa (2.50 kgf/cm², 36 psi)

Maximum load*:

MT07 176 kg (388 lb)

MT07A 173 kg (381 lb)

* Total weight of rider, passenger, cargo and accessories

EWA10512



WARNING

Never overload your vehicle. Operation of an overloaded vehicle could cause an accident.

Tire inspection

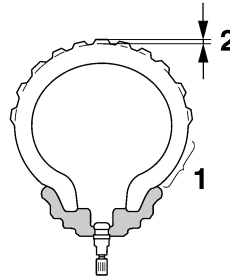

1. Tire sidewall
2. Tire tread depth

The tires must be checked before each ride. If the center tread depth reaches the specified limit, if the tire has a nail or glass fragments in it, or if the sidewall is cracked, have a Yamaha dealer replace the tire immediately.

Minimum tire tread depth (front and rear):

1.6 mm (0.06 in)

TIP

The tire tread depth limits may differ from country to country. Always comply with the local regulations.



WARNING

- Have a Yamaha dealer replace excessively worn tires. Besides being illegal, operating the vehicle with excessively worn tires decreases riding stability and can lead to loss of control.
- The replacement of all wheel and brake-related parts, including the tires, should be left to a Yamaha dealer, who has the necessary professional knowledge and experience to do so.
- Ride at moderate speeds after changing a tire since the tire surface must first be “broken in” for it to develop its optimal characteristics.

EWA10472

PERIODIC MAINTENANCE AND ADJUSTMENT

EWA10601

Tire information

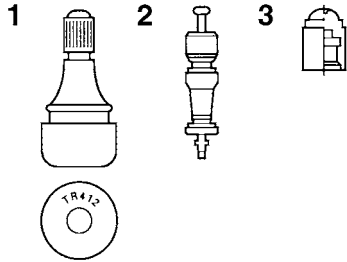

1. Tire air valve
2. Tire air valve core
3. Tire air valve cap with seal

6

This motorcycle is equipped with tubeless tires and rubber tire air valves. Tires age, even if they have not been used or have only been used occasionally. Cracking of the tread and sidewall rubber, sometimes accompanied by carcass deformation, is an evidence of aging. Old and aged tires shall be checked by tire specialists to ascertain their suitability for further use.

EWA10482

⚠ WARNING

- **The front and rear tires should be of the same make and design, otherwise the handling**

characteristics of the motorcycle may be different, which could lead to an accident.

- **Always make sure that the valve caps are securely installed to prevent air pressure leakage.**
- **Use only the tire valves and valve cores listed below to avoid tire deflation during a high-speed ride.**

After extensive tests, only the tires listed below have been approved for this model by Yamaha Motor Co., Ltd.

Front tire:

Size:
120/70 ZR17M/C (58W)
Manufacturer/model:
MICHELIN/PILOT ROAD 3
BRIDGESTONE/BT023F F

Rear tire:

Size:
180/55 ZR17M/C (73W)
Manufacturer/model:
MICHELIN/PILOT ROAD 3A
BRIDGESTONE/BT023R M

FRONT and REAR:

Tire air valve:
TR412
Valve core:
#9100 (original)

⚠ WARNING

This motorcycle is fitted with super-high-speed tires. Note the following points in order to make the most efficient use of these tires.

- **Use only the specified replacement tires. Other tires may run the danger of bursting at super high speeds.**
- **Brand-new tires can have a relatively poor grip on certain road surfaces until they have been “broken in”. Therefore, it is advisable before doing any high-speed riding to ride conservatively for approximately 100 km (60 mi) after installing a new tire.**
- **The tires must be warmed up before a high-speed run.**
- **Always adjust the tire air pressure according to the operating conditions.**

PERIODIC MAINTENANCE AND ADJUSTMENT

EAU21963

EAU33892

Cast wheels

To maximize the performance, durability, and safe operation of your vehicle, note the following points regarding the specified wheels.

- The wheel rims should be checked for cracks, bends, warpage or other damage before each ride. If any damage is found, have a Yamaha dealer replace the wheel. Do not attempt even the smallest repair to the wheel. A deformed or cracked wheel must be replaced.
- The wheel should be balanced whenever either the tire or wheel has been changed or replaced. An unbalanced wheel can result in poor performance, adverse handling characteristics, and a shortened tire life.

Adjusting the clutch lever free play

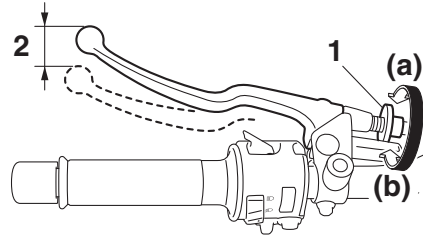

1. Clutch lever free play adjusting bolt
2. Clutch lever free play

The clutch lever free play should measure 5.0–10.0 mm (0.20–0.39 in) as shown. Periodically check the clutch lever free play and, if necessary, adjust it as follows.

To increase the clutch lever free play, turn the clutch lever free play adjusting bolt at the clutch lever in direction (a). To decrease the clutch lever free play, turn the adjusting bolt in direction (b).

TIP

If the specified clutch lever free play cannot be obtained as described above, proceed as follows.

1. Fully turn the adjusting bolt at the clutch lever in direction (a) to loosen the clutch cable.
2. Loosen the locknut at the crankcase.
3. To increase the clutch lever free play, turn the clutch lever free play adjusting nut in direction (a). To decrease the clutch lever free play, turn the adjusting nut in direction (b).

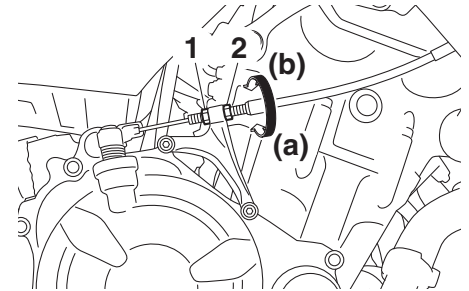

1. Locknut
2. Clutch lever free play adjusting nut

4. Tighten the locknut.

PERIODIC MAINTENANCE AND ADJUSTMENT

Checking the brake lever free play

EAU37914

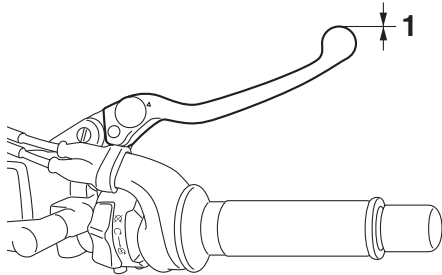

1. No brake lever free play

There should be no free play at the brake lever end. If there is free play, have a Yamaha dealer inspect the brake system.

EWA14212

⚠ WARNING

A soft or spongy feeling in the brake lever can indicate the presence of air in the hydraulic system. If there is air in the hydraulic system, have a Yamaha dealer bleed the system before operating the vehicle. Air in the hydraulic system will diminish the

braking performance, which may result in loss of control and an accident.

Brake light switches

EAU57070

For non-ABS models

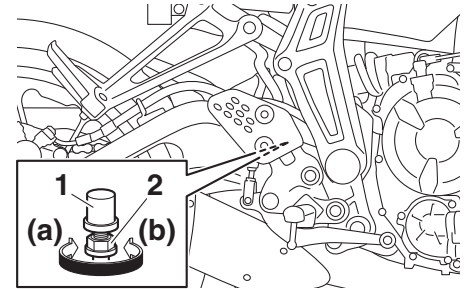

1. Rear brake light switch
2. Rear brake light switch adjusting nut

The brake light, which is activated by the brake pedal and brake lever, should come on just before braking takes effect. If necessary, adjust the rear brake light switch as follows, but the front brake light switch should be adjusted by a Yamaha dealer.

Turn the rear brake light switch adjusting nut while holding the rear brake light switch in place. To make the brake light come on earlier, turn the ad-

PERIODIC MAINTENANCE AND ADJUSTMENT

justing nut in direction (a). To make the brake light come on later, turn the adjusting nut in direction (b).

For ABS models

The brake light, which is activated by the brake pedal and brake lever, should come on just before braking takes effect. If necessary, have a Yamaha dealer adjust the brake light switches.

Checking the front and rear brake pads

EAU22393

The front and rear brake pads must be checked for wear at the intervals specified in the periodic maintenance and lubrication chart.

Front brake pads

EAU36891

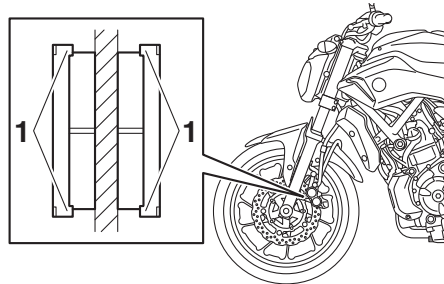

1. Brake pad wear indicator

Each front brake pad is provided with wear indicators, which allows you to check the brake pad wear without having to disassemble the brake. To check the brake pad wear, check the position of the wear indicators while applying the brake. If a brake pad has worn to the point that a wear indicator almost

touches the brake disc, have a Yamaha dealer replace the brake pads as a set.

Rear brake pads

EAU46292

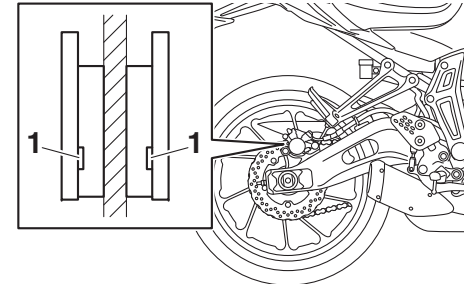

1. Brake pad wear indicator groove

Each rear brake pad is provided with wear indicator grooves, which allow you to check the brake pad wear without having to disassemble the brake. To check the brake pad wear, check the wear indicator grooves. If a brake pad has worn to the point that a wear indicator groove almost appears, have a Yamaha dealer replace the brake pads as a set.

PERIODIC MAINTENANCE AND ADJUSTMENT

Checking the brake fluid level

EAU40262

Before riding, check that the brake fluid is above the minimum level mark. Check the brake fluid level with the top of the reservoir level. Replenish the brake fluid if necessary.

Front brake

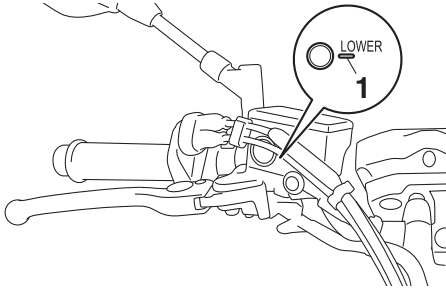

1. Minimum level mark

Rear brake

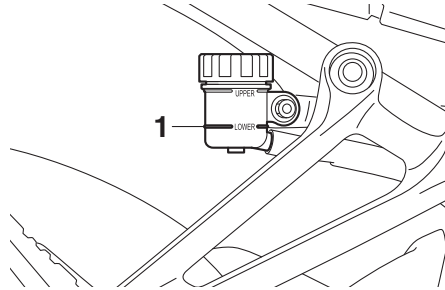

1. Minimum level mark

Specified brake fluid:
DOT 4

EWA16011

WARNING

Improper maintenance can result in loss of braking ability. Observe these precautions:

- Insufficient brake fluid may allow air to enter the brake system, reducing braking performance.
- Clean the filler cap before removing. Use only DOT 4 brake fluid from a sealed container.

- Use only the specified brake fluid; otherwise, the rubber seals may deteriorate, causing leakage.
- Refill with the same type of brake fluid. Adding a brake fluid other than DOT 4 may result in a harmful chemical reaction.
- Be careful that water or dust does not enter the brake fluid reservoir when refilling. Water will significantly lower the boiling point of the fluid and may result in vapor lock, and dirt may clog the ABS hydraulic unit valves.

ECA17641

NOTICE

Brake fluid may damage painted surfaces or plastic parts. Always clean up spilled fluid immediately.

As the brake pads wear, it is normal for the brake fluid level to gradually go down. A low brake fluid level may indicate worn brake pads and/or brake system leakage; therefore, be sure to check the brake pads for wear and the brake system for leakage. If the brake

PERIODIC MAINTENANCE AND ADJUSTMENT

fluid level goes down suddenly, have a Yamaha dealer check the cause before further riding.

Changing the brake fluid

EAU22733

Have a Yamaha dealer change the brake fluid at the intervals specified in the periodic maintenance and lubrication chart. In addition, have the oil seals of the master cylinders and calipers as well as the brake hoses replaced at the intervals listed below or whenever they are damaged or leaking.

- Oil seals: Replace every two years.
- Brake hoses: Replace every four years.

Drive chain slack

EAU22762

The drive chain slack should be checked before each ride and adjusted if necessary.

To check the drive chain slack

EAU60040

1. Place the motorcycle on the side-stand.

TIP _____

When checking and adjusting the drive chain slack, there should be no weight on the motorcycle.

2. Shift the transmission into the neutral position.
3. Push down on the drive chain under the end of the drive chain guide with a force of 15 N (1.5 kgf, 3.0 lbf).
4. Measure the drive chain slack between the drive chain guide and the center of the chain as shown.

Drive chain slack:

51.0–56.0 mm (2.01–2.20 in)

PERIODIC MAINTENANCE AND ADJUSTMENT

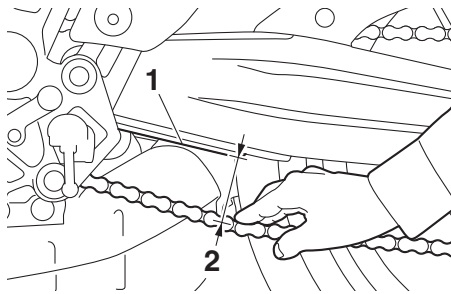

1. Drive chain guide
2. Drive chain slack

5. If the drive chain slack is incorrect, adjust it as follows.

To adjust the drive chain slack

EAU59920

Consult a Yamaha dealer before adjusting the drive chain slack.

1. Loosen the locknut at each end of the swingarm, and then loosen the axle nut.

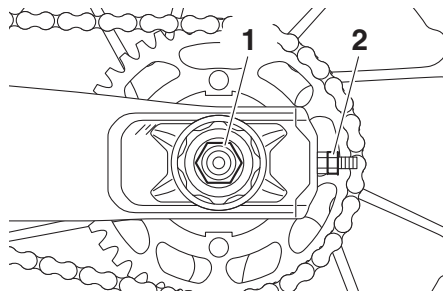

1. Axle nut
2. Locknut

2. To tighten the drive chain, turn the drive chain slack adjusting nut at each end of the swingarm in direction (a). To loosen the drive chain, turn the adjusting nut at each end of the swingarm in direction (b), and then push the rear wheel forward. **NOTICE: Improper drive chain slack will overload the engine as well as other vital parts of the motorcycle and can lead to chain slippage or breakage. If the drive chain slack is more than 58.0 mm (2.28 in), the chain can damage the frame, swingarm, and other parts. To prevent**

this from occurring, keep the drive chain slack within the specified limits. [ECA17791]

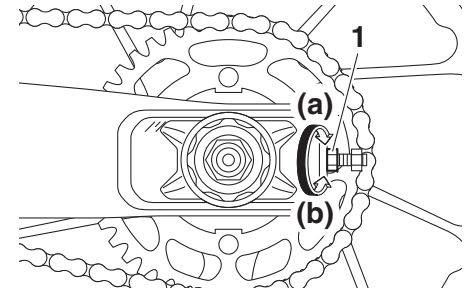

1. Drive chain slack adjusting nut

TIP

Using the alignment marks on each side of the swingarm, make sure that both drive chain slack adjusting plates are in the same position for proper wheel alignment.

PERIODIC MAINTENANCE AND ADJUSTMENT

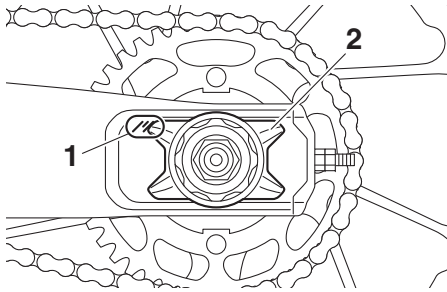

1. Alignment marks
2. Drive chain slack adjusting plate
3. Tighten the axle nut, and then tighten the locknuts to the specified torques.

Tightening torques:

Axle nut:

105 Nm (10.5 m·kgf, 76 ft·lbf)

Locknut:

16 Nm (1.6 m·kgf, 12 ft·lbf)

4. Make sure that the drive chain slack adjusting plates are in the same position, the drive chain slack is correct, and the drive chain moves smoothly.

Cleaning and lubricating the drive chain

EAU23026

The drive chain must be cleaned and lubricated at the intervals specified in the periodic maintenance and lubrication chart, otherwise it will quickly wear out, especially when riding in dusty or wet areas. Service the drive chain as follows.

ECA10584

NOTICE

The drive chain must be lubricated after washing the motorcycle, riding in the rain or riding in wet areas.

1. Clean the drive chain with kerosene and a small soft brush.
NOTICE: To prevent damaging the O-rings, do not clean the drive chain with steam cleaners, high-pressure washers or inappropriate solvents. [ECA11122]
2. Wipe the drive chain dry.
3. Thoroughly lubricate the drive chain with a special O-ring chain lubricant. **NOTICE:** Do not use engine oil or any other lubricants for the drive chain, as they

may contain substances that could damage the O-rings.

[ECA11112]

PERIODIC MAINTENANCE AND ADJUSTMENT

6

Checking and lubricating the cables

EAU23098

The operation of all control cables and the condition of the cables should be checked before each ride, and the cables and cable ends should be lubricated if necessary. If a cable is damaged or does not move smoothly, have a Yamaha dealer check or replace it. **WARNING! Damage to the outer housing of cables may result in internal rusting and cause interference with cable movement. Replace damaged cables as soon as possible to prevent unsafe conditions.** [EWA10712]

Recommended lubricant:
Yamaha cable lubricant or other suitable cable lubricant

Checking and lubricating the throttle grip and cable

EAU23115

The operation of the throttle grip should be checked before each ride. In addition, the cable should be lubricated by a Yamaha dealer at the intervals specified in the periodic maintenance chart.

The throttle cable is equipped with a rubber cover. Make sure that the cover is securely installed. Even though the cover is installed correctly, it does not completely protect the cable from water entry. Therefore, use care not to pour water directly onto the cover or cable when washing the vehicle. If the cable or cover becomes dirty, wipe clean with a moist cloth.

Checking and lubricating the brake and shift pedals

EAU44275

The operation of the brake and shift pedals should be checked before each ride, and the pedal pivots should be lubricated if necessary.

Brake pedal

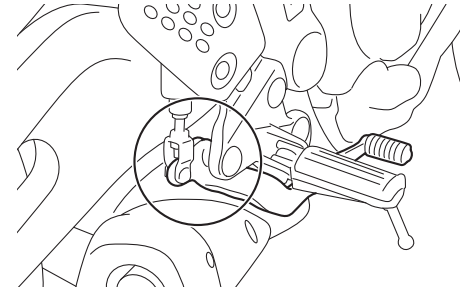

Shift pedal

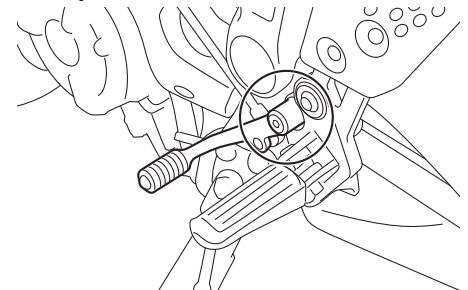

PERIODIC MAINTENANCE AND ADJUSTMENT

Recommended lubricant:
Lithium-soap-based grease

Checking and lubricating the ^{EAU23144}brake and clutch levers

The operation of the brake and clutch levers should be checked before each ride, and the lever pivots should be lubricated if necessary.

Recommended lubricants:
Brake lever:
Silicone grease
Clutch lever:
Lithium-soap-based grease

Brake lever

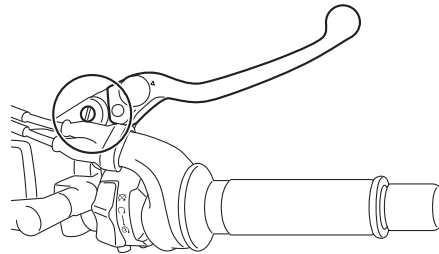

Clutch lever

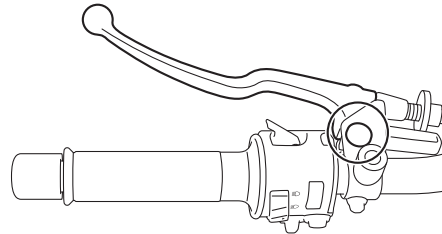

PERIODIC MAINTENANCE AND ADJUSTMENT

Checking and lubricating the sidestand

EAU23203

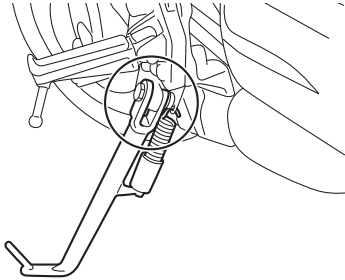

The operation of the sidestand should be checked before each ride, and the sidestand pivot and metal-to-metal contact surfaces should be lubricated if necessary.

EWA10732

⚠ WARNING

If the sidestand does not move up and down smoothly, have a Yamaha dealer check or repair it. Otherwise, the sidestand could contact the ground and distract the operator, resulting in a possible loss of control.

Recommended lubricant:
Lithium-soap-based grease

Lubricating the rear suspension

EAU23252



The pivoting points of the rear suspension must be lubricated by a Yamaha dealer at the intervals specified in the periodic maintenance and lubrication chart.

Recommended lubricant:
Lithium-soap-based grease

Lubricating the swingarm pivots

EAUM1653

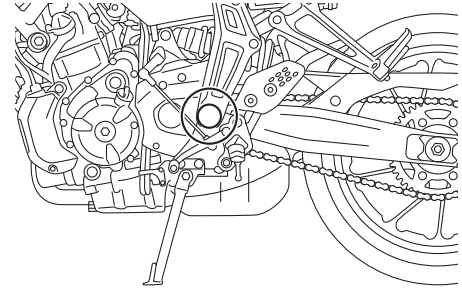

The swingarm pivots must be lubricated by a Yamaha dealer at the intervals specified in the periodic maintenance and lubrication chart.

Recommended lubricant:
Lithium-soap-based grease

PERIODIC MAINTENANCE AND ADJUSTMENT

EAU23273

Checking the front fork

The condition and operation of the front fork must be checked as follows at the intervals specified in the periodic maintenance and lubrication chart.

To check the condition

Check the inner tubes for scratches, damage and excessive oil leakage.

To check the operation

1. Place the vehicle on a level surface and hold it in an upright position. **WARNING! To avoid injury, securely support the vehicle so there is no danger of it falling over.** [EWA10752]
2. While applying the front brake, push down hard on the handlebars several times to check if the front fork compresses and rebounds smoothly.

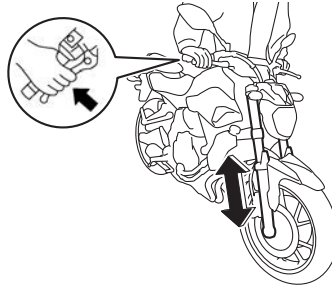

ECA10591

NOTICE

If any damage is found or the front fork does not operate smoothly, have a Yamaha dealer check or repair it.

EAU23284

Checking the steering

Worn or loose steering bearings may cause danger. Therefore, the operation of the steering must be checked as follows at the intervals specified in the periodic maintenance and lubrication chart.

1. Place a stand under the engine to raise the front wheel off the ground. (See page 6-36 for more information.) **WARNING! To avoid injury, securely support the vehicle so there is no danger of it falling over.** [EWA10752]
2. Hold the lower ends of the front fork legs and try to move them forward and backward. If any free play can be felt, have a Yamaha dealer check or repair the steering.

PERIODIC MAINTENANCE AND ADJUSTMENT

6

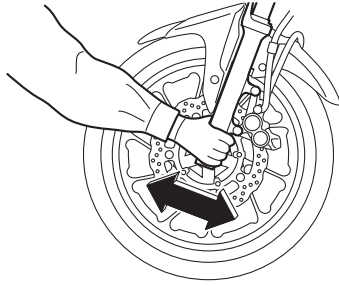

Checking the wheel bearings

EAU23292

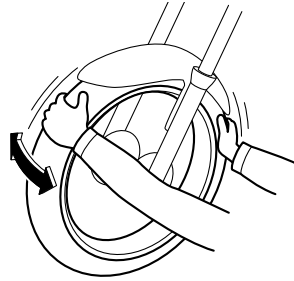

The front and rear wheel bearings must be checked at the intervals specified in the periodic maintenance and lubrication chart. If there is play in the wheel hub or if the wheel does not turn smoothly, have a Yamaha dealer check the wheel bearings.

Battery

EAU50211

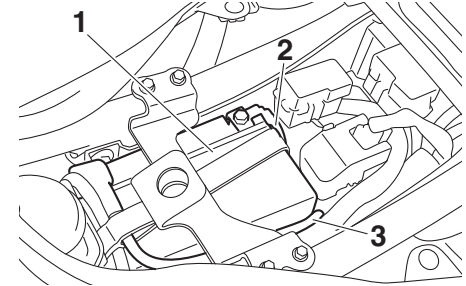

1. Battery
2. Negative battery lead (black)
3. Positive battery lead (red)

The battery is located under the rider seat. (See page 3-19.)

This model is equipped with a VRLA (Valve Regulated Lead Acid) battery. There is no need to check the electrolyte or to add distilled water. However, the battery lead connections need to be checked and, if necessary, tightened.

EWA10761

WARNING

- **Electrolyte is poisonous and dangerous since it contains sulfuric acid, which causes severe**

PERIODIC MAINTENANCE AND ADJUSTMENT

burns. Avoid any contact with skin, eyes or clothing and always shield your eyes when working near batteries. In case of contact, administer the following FIRST AID.

- **EXTERNAL:** Flush with plenty of water.
- **INTERNAL:** Drink large quantities of water or milk and immediately call a physician.
- **EYES:** Flush with water for 15 minutes and seek prompt medical attention.
- **Batteries produce explosive hydrogen gas. Therefore, keep sparks, flames, cigarettes, etc., away from the battery and provide sufficient ventilation when charging it in an enclosed space.**
- **KEEP THIS AND ALL BATTERIES OUT OF THE REACH OF CHILDREN.**

To charge the battery

Have a Yamaha dealer charge the battery as soon as possible if it seems to have discharged. Keep in mind that the

battery tends to discharge more quickly if the vehicle is equipped with optional electrical accessories.

ECA16522

NOTICE

To charge a VRLA (Valve Regulated Lead Acid) battery, a special (constant-voltage) battery charger is required. Using a conventional battery charger will damage the battery.

To store the battery

1. If the vehicle will not be used for more than one month, remove the battery, fully charge it, and then place it in a cool, dry place. **NOTICE: When removing the battery, be sure the key is turned to “OFF”, then disconnect the negative lead before disconnecting the positive lead.**

[ECA16303]

2. If the battery will be stored for more than two months, check it at least once a month and fully charge it if necessary.
3. Fully charge the battery before installation. **NOTICE: When installing the battery, be sure the key**

is turned to “OFF”, then connect the positive lead before connecting the negative lead. [ECA16841]

4. After installation, make sure that the battery leads are properly connected to the battery terminals.

ECA16531

NOTICE

Always keep the battery charged. Storing a discharged battery can cause permanent battery damage.

PERIODIC MAINTENANCE AND ADJUSTMENT

EAU59870

Replacing the fuses

The main fuse and the fuse boxes, which contain the fuses for the individual circuits, are located under the rider seat. (See page 3-19.)

TIP

To access the main fuse, remove the starter relay cover as shown.

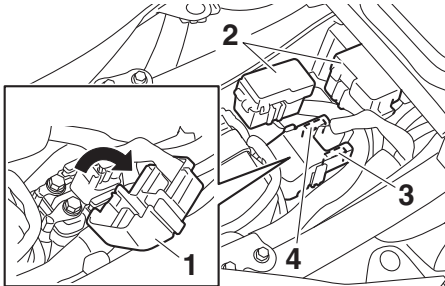

1. Starter relay cover
2. Fuse box
3. Spare main fuse
4. Main fuse

MT07

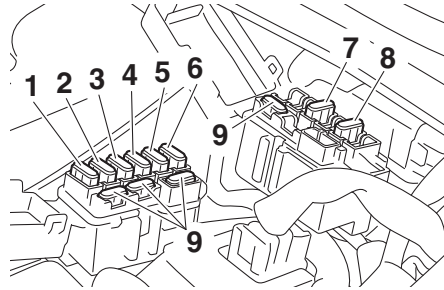

1. Ignition fuse
2. Signaling system fuse
3. Headlight fuse
4. Fuel injection system fuse
5. Backup fuse (for clock and immobilizer system)
6. Radiator fan fuse
7. Parking lighting fuse
8. Auxiliary fuse
9. Spare fuse

MT07A

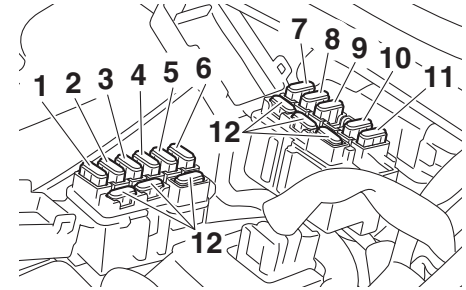

1. Ignition fuse
2. Signaling system fuse
3. Headlight fuse
4. Fuel injection system fuse
5. Backup fuse (for clock and immobilizer system)
6. Radiator fan fuse
7. ABS solenoid fuse
8. ABS motor fuse
9. Parking lighting fuse
10. Auxiliary fuse
11. ABS control unit fuse
12. Spare fuse

If a fuse is blown, replace it as follows.

1. Turn the key to "OFF" and turn off the electrical circuit in question.
2. Remove the blown fuse, and then install a new fuse of the specified amperage. **WARNING! Do not**

PERIODIC MAINTENANCE AND ADJUSTMENT

use a fuse of a higher amperage rating than recommended to avoid causing extensive damage to the electrical system and possibly a fire. [EWA15132]

Specified fuses:

Main fuse:

30.0 A

Auxiliary fuse:

2.0 A

Headlight fuse:

15.0 A

Signaling system fuse:

10.0 A

Ignition fuse:

10.0 A

Parking lighting fuse:

7.5 A

Radiator fan fuse:

10.0 A

ABS motor fuse:

MT07A 30.0 A

ABS solenoid fuse:

MT07A 20.0 A

Fuel injection system fuse:

10.0 A

ABS control unit fuse:

MT07A 7.5 A

Backup fuse:

7.5 A

3. Turn the key to “ON” and turn on the electrical circuit in question to check if the device operates.
4. If the fuse immediately blows again, have a Yamaha dealer check the electrical system.

Replacing the headlight bulb

EAU59881

This model is equipped with a halogen bulb headlight. If the headlight bulb burns out, replace it as follows.

ECA10651

NOTICE

Take care not to damage the following parts:

- **Headlight bulb**

Do not touch the glass part of the headlight bulb to keep it free from oil, otherwise the transparency of the glass, the luminosity of the bulb, and the bulb life will be adversely affected. Thoroughly clean off any dirt and fingerprints on the headlight bulb using a cloth moistened with alcohol or thinner.

- **Headlight lens**

Do not affix any type of tinted film or stickers to the headlight lens.

Do not use a headlight bulb of a wattage higher than specified.

PERIODIC MAINTENANCE AND ADJUSTMENT

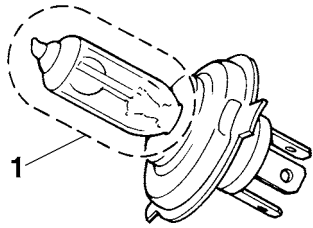

1. Do not touch the glass part of the bulb.

1. Remove the headlight unit by removing the bolt and washer on each side.

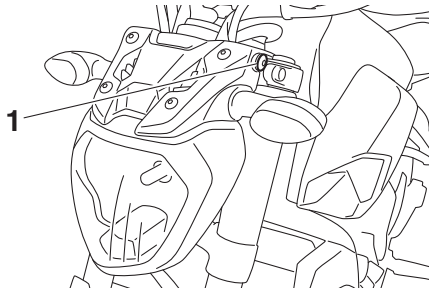

1. Bolt and washer

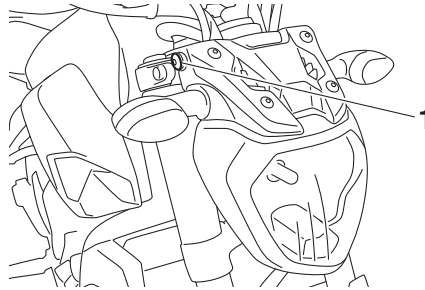

1. Bolt and washer

2. Disconnect the headlight coupler, and then remove the headlight bulb cover.

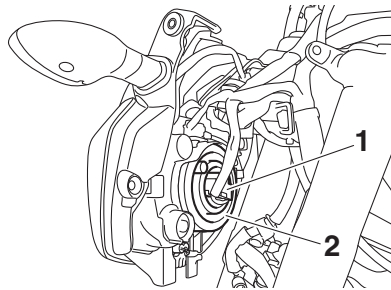

1. Headlight coupler
2. Headlight bulb cover

3. Unhook the headlight bulb holder, then remove the burnt-out bulb.

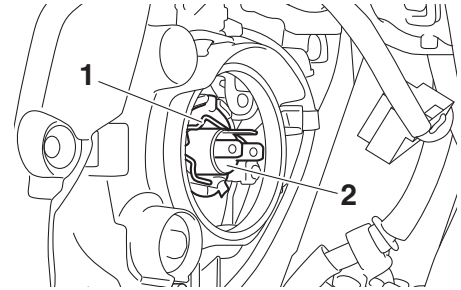

1. Headlight bulb holder
2. Headlight bulb

4. Place a new headlight bulb into position, then secure it with the bulb holder.
5. Install the headlight bulb cover, then connect the coupler.
6. Install the headlight unit as shown, and then install the washer and bolt on each side.

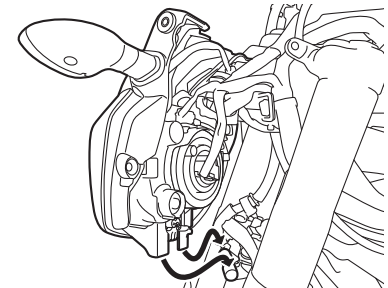

PERIODIC MAINTENANCE AND ADJUSTMENT

7. Have a Yamaha dealer adjust the headlight beam if necessary.

Tail/brake light

EAU24182

This model is equipped with an LED-type tail/brake light. If the tail/brake light does not come on, have a Yamaha dealer check it.

Replacing a turn signal light bulb

EAU24205

1. Remove the turn signal light lens by removing the screw.

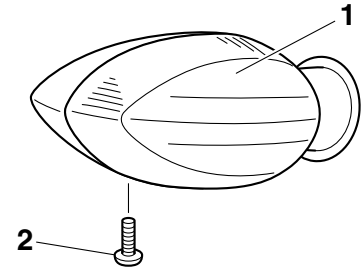

1. Turn signal light lens
2. Screw

2. Remove the burnt-out bulb by pushing it in and turning it counterclockwise.

PERIODIC MAINTENANCE AND ADJUSTMENT

EAU59890

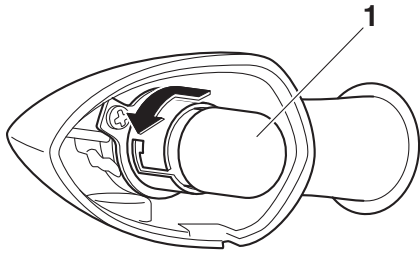

1. Turn signal light bulb
3. Insert a new bulb into the socket, push it in, and then turn it clockwise until it stops.
4. Install the lens by installing the screw. **NOTICE: Do not over-tighten the screw, otherwise the lens may break.** [ECA11192]

Replacing the license plate light bulb

1. Remove the license plate light unit by removing the nuts, washers and collars, and then remove the license plate light bulb socket (together with the bulb) by pulling it out.

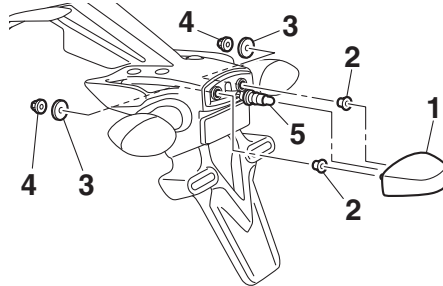

1. License plate light unit
2. Collar
3. Washer
4. Nut
5. License plate light bulb socket

2. Remove the burnt-out bulb by pulling it out.

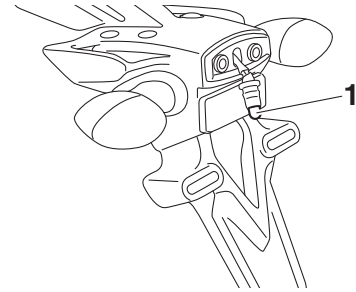

1. License plate light bulb
3. Insert a new bulb into the socket.
4. Install the socket (together with the bulb) by pushing it in, and then install the license plate light unit by installing the collars, washers and nuts.

Replacing the auxiliary light bulb

EAU46405

If the auxiliary light bulb burns out, replace it as follows.

1. Remove the headlight unit. (See page 6-32.)
2. Remove the auxiliary light bulb socket (together with the bulb) by turning it counterclockwise.

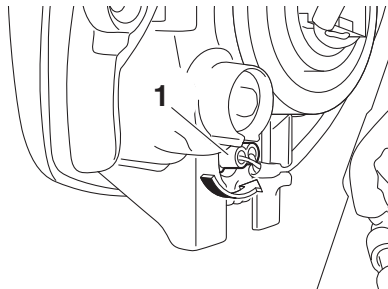

1. Auxiliary light bulb socket

3. Remove the burnt-out bulb by pulling it out of the socket.

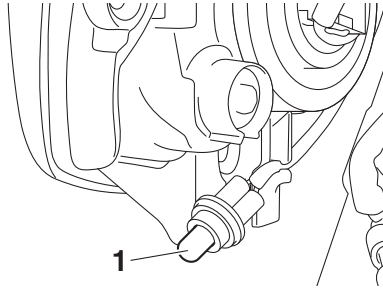

1. Auxiliary light bulb

4. Insert a new bulb into the socket.
5. Install the socket (together with the bulb) by turning it clockwise.
6. Install the headlight unit.

Supporting the motorcycle

EAU24351

Since this model is not equipped with a centerstand, follow these precautions when removing the front and rear wheel or performing other maintenance requiring the motorcycle to stand upright. Check that the motorcycle is in a stable and level position before starting any maintenance. A strong wooden box can be placed under the engine for added stability.

To service the front wheel

1. Stabilize the rear of the motorcycle by using a motorcycle stand or, if an additional motorcycle stand is not available, by placing a jack under the frame in front of the rear wheel.
2. Raise the front wheel off the ground by using a motorcycle stand.

To service the rear wheel

Raise the rear wheel off the ground by using a motorcycle stand or, if a motorcycle stand is not available, by placing

PERIODIC MAINTENANCE AND ADJUSTMENT

a jack either under each side of the frame in front of the rear wheel or under each side of the swingarm.

Front wheel (for non-ABS models)

EAU44792

WARNING

EWA14841

For the ABS model, have a Yamaha dealer remove and install the wheel.

EAU59931

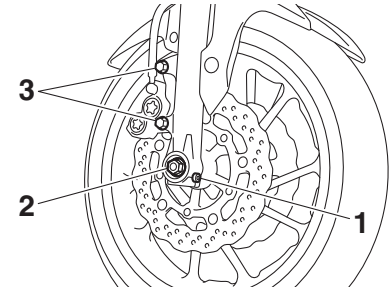

1. Front wheel axle pinch bolt
2. Wheel axle
3. Brake caliper bolt

To remove the front wheel

EWA10822

WARNING

To avoid injury, securely support the vehicle so there is no danger of it falling over.

1. Loosen the front wheel axle pinch bolt, then the wheel axle and the brake caliper bolts.

2. Lift the front wheel off the ground according to the procedure in the previous section “Supporting the motorcycle”.
3. Remove the brake hose holder on the left side by removing the bolt.

PERIODIC MAINTENANCE AND ADJUSTMENT

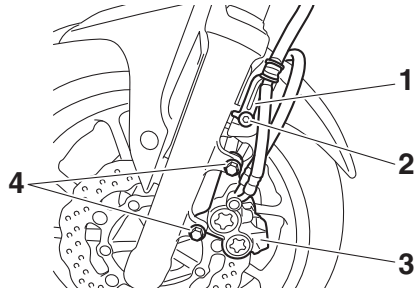

1. Brake hose holder
2. Bolt
3. Brake caliper
4. Brake caliper bolt

4. Remove the brake caliper on each side by removing the bolts.
NOTICE: Do not apply the brake after the brake calipers have been removed, otherwise the brake pads will be forced shut.

[ECA11052]

5. Pull the wheel axle out, and then remove the wheel.

To install the front wheel

1. Lift the wheel up between the fork legs.
2. Insert the wheel axle from the right side.

3. Lower the front wheel so that it is on the ground, and then put the sidestand down.
4. Install the brake calipers by installing the bolts.

TIP

Make sure that there is enough space between the brake pads before installing the brake calipers onto the brake discs.

5. Install the brake hose holder by installing the bolt.
6. Tighten the brake caliper bolts and the brake hose holder bolt to the specified torques.

Tightening torques:

Brake caliper bolt:
40 Nm (4.0 m·kgf, 29 ft·lbf)
Brake hose holder bolt:
7 Nm (0.7 m·kgf, 5.1 ft·lbf)

7. Tighten the wheel axle, and then the wheel axle pinch bolt to the specified torques.

Tightening torques:

Wheel axle:
65 Nm (6.5 m·kgf, 47 ft·lbf)
Front wheel axle pinch bolt:
23 Nm (2.3 m·kgf, 17 ft·lbf)

8. Push down hard on the handlebar several times to check for proper fork operation.

PERIODIC MAINTENANCE AND ADJUSTMENT

Rear wheel (for non-ABS models)

EAU44802

⚠ WARNING

EWA14841

For the ABS model, have a Yamaha dealer remove and install the wheel.

EAU59940

To remove the rear wheel

EWA10822

⚠ WARNING

To avoid injury, securely support the vehicle so there is no danger of it falling over.

1. Loosen the locknut and drive chain slack adjusting nut on each side of the swingarm.
2. Loosen the axle nut.

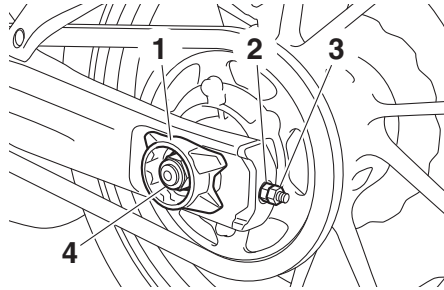

1. Drive chain slack adjusting plate
2. Drive chain slack adjusting nut
3. Locknut
4. Axle nut

3. Lift the rear wheel off the ground according to the procedure on page 6-36.
4. Remove the axle nut and the drive chain slack adjusting plate.
5. Push the wheel forward, and then remove the drive chain from the rear sprocket.

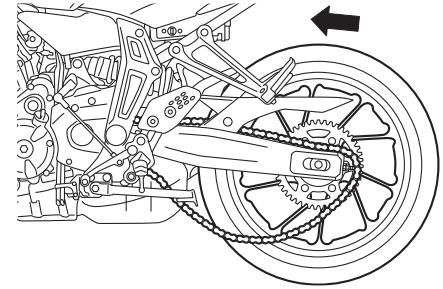

TIP

- If the drive chain is difficult to remove, remove the wheel axle first, and then lift the wheel upward enough to remove the drive chain from the rear sprocket.
- The drive chain does not need to be disassembled in order to remove and install the rear wheel.

6. While supporting the brake caliper and slightly lifting the wheel, pull the wheel axle out and remove the drive chain slack adjusting plate.

PERIODIC MAINTENANCE AND ADJUSTMENT

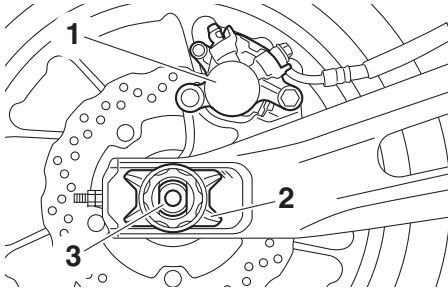

1. Brake caliper
2. Drive chain slack adjusting plate
3. Wheel axle

TIP
A rubber mallet may be useful to tap the wheel axle out.

7. Remove the wheel. **NOTICE: Do not apply the brake after the wheel and brake disc have been removed, otherwise the brake pads will be forced shut.** [ECA11073]

To install the rear wheel

1. Install the wheel, the brake caliper bracket, and the drive chain slack adjusting plate by inserting the wheel axle from the right-hand side.

- TIP**
- Make sure that the slot in the brake caliper bracket is fit over the retainer on the swingarm.
 - Make sure that there is enough space between the brake pads before installing the wheel.
 - Make sure that the arrow mark on each chain puller is pointing upward.

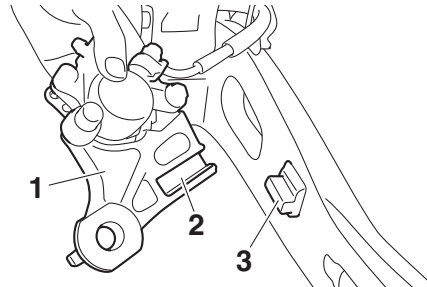

1. Brake caliper bracket
2. Slot
3. Retainer

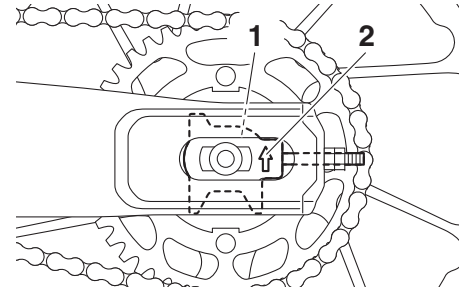

1. Drive chain puller
2. Arrow mark
2. Install the drive chain onto the rear sprocket.
3. Install the drive chain slack adjusting plate and the axle nut.
4. Lower the rear wheel so that it is on the ground, and then put the sidestand down.
5. Adjust the drive chain slack. (See page 6-22.)
6. Tighten the axle nut, and then tighten the locknuts to the specified torques.

PERIODIC MAINTENANCE AND ADJUSTMENT

Tightening torques:

Axle nut:

105 Nm (10.5 m·kgf, 76 ft·lbf)

Locknut:

16 Nm (1.6 m·kgf, 12 ft·lbf)

EAU25872

Troubleshooting

Although Yamaha motorcycles receive a thorough inspection before shipment from the factory, trouble may occur during operation. Any problem in the fuel, compression, or ignition systems, for example, can cause poor starting and loss of power.

The following troubleshooting charts represent quick and easy procedures for checking these vital systems yourself. However, should your motorcycle require any repair, take it to a Yamaha dealer, whose skilled technicians have the necessary tools, experience, and know-how to service the motorcycle properly.

Use only genuine Yamaha replacement parts. Imitation parts may look like Yamaha parts, but they are often inferior, have a shorter service life and can lead to expensive repair bills.

EWA15142



When checking the fuel system, do not smoke, and make sure there are no open flames or sparks in the area, including pilot lights from water

heaters or furnaces. Gasoline or gasoline vapors can ignite or explode, causing severe injury or property damage.

Troubleshooting charts

Starting problems or poor engine performance

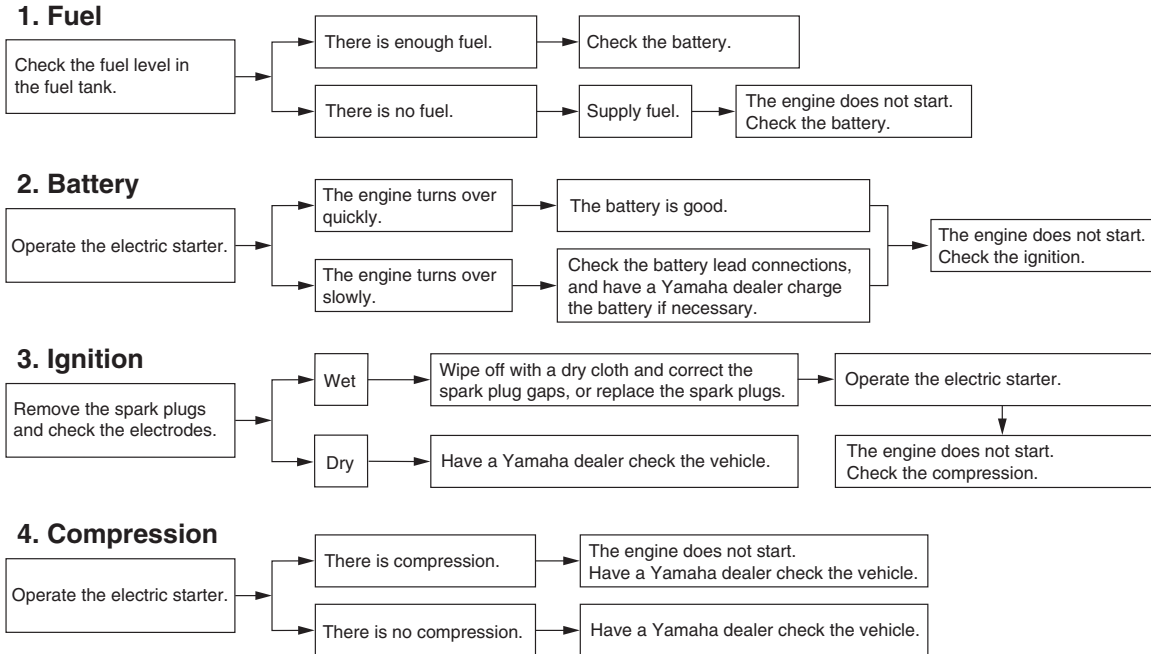

PERIODIC MAINTENANCE AND ADJUSTMENT

Engine overheating

EWA10401

⚠ WARNING

- Do not remove the radiator cap when the engine and radiator are hot. Scalding hot fluid and steam may be blown out under pressure, which could cause serious injury. Be sure to wait until the engine has cooled.
- After removing the radiator cap retaining bolt, place a thick rag, like a towel, over the radiator cap, and then slowly rotate the cap counterclockwise to the detent to allow any residual pressure to escape. When the hissing sound has stopped, press down on the cap while turning it counterclockwise, and then remove the cap.

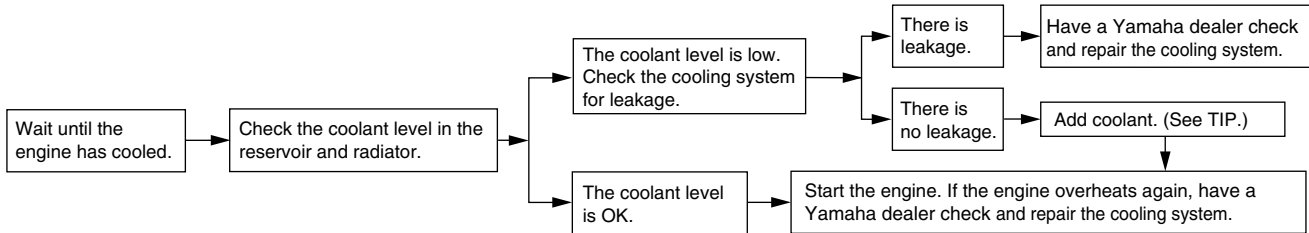

TIP

If coolant is not available, tap water can be temporarily used instead, provided that it is changed to the recommended coolant as soon as possible.

Matte color caution

EAU37834

NOTICE

Some models are equipped with matte colored finished parts. Be sure to consult a Yamaha dealer for advice on what products to use before cleaning the vehicle. Using a brush, harsh chemical products or cleaning compounds when cleaning these parts will scratch or damage their surface. Wax also should not be applied to any matte colored finished parts.

ECA15193

Care

EAU26015

While the open design of a motorcycle reveals the attractiveness of the technology, it also makes it more vulnerable. Rust and corrosion can develop even if high-quality components are used. A rusty exhaust pipe may go unnoticed on a car, however, it detracts from the overall appearance of a motorcycle. Frequent and proper care does not only comply with the terms of the warranty, but it will also keep your motorcycle looking good, extend its life and optimize its performance.

Before cleaning

1. Cover the muffler outlet with a plastic bag after the engine has cooled down.
2. Make sure that all caps and covers as well as all electrical couplers and connectors, including the spark plug caps, are tightly installed.
3. Remove extremely stubborn dirt, like oil burnt onto the crankcase, with a degreasing agent and a brush, but never apply such prod-

ucts onto seals, gaskets, sprockets, the drive chain and wheel axles. Always rinse the dirt and degreaser off with water.

Cleaning

ECA10773

NOTICE

- Avoid using strong acidic wheel cleaners, especially on spoked wheels. If such products are used on hard-to-remove dirt, do not leave the cleaner on the affected area any longer than instructed. Also, thoroughly rinse the area off with water, immediately dry it, and then apply a corrosion protection spray.
- Improper cleaning can damage plastic parts (such as cowlings, panels, windshields, headlight lenses, meter lenses, etc.) and the mufflers. Use only a soft, clean cloth or sponge with water to clean plastic. However, if the plastic parts cannot be thoroughly cleaned with water, diluted mild detergent with water may be used. Be sure to rinse

MOTORCYCLE CARE AND STORAGE

off any detergent residue using plenty of water, as it is harmful to plastic parts.

- Do not use any harsh chemical products on plastic parts. Be sure to avoid using cloths or sponges which have been in contact with strong or abrasive cleaning products, solvent or thinner, fuel (gasoline), rust removers or inhibitors, brake fluid, antifreeze or electrolyte.
- Do not use high-pressure washers or steam-jet cleaners since they cause water seepage and deterioration in the following areas: seals (of wheel and swing-arm bearings, fork and brakes), electric components (couplers, connectors, instruments, switches and lights), breather hoses and vents.
- For motorcycles equipped with a windshield: Do not use strong cleaners or hard sponges as they will cause dulling or scratching. Some cleaning compounds for plastic may leave scratches on the wind-

shield. Test the product on a small hidden part of the windshield to make sure that it does not leave any marks. If the windshield is scratched, use a quality plastic polishing compound after washing.

After normal use

Remove dirt with warm water, a mild detergent, and a soft, clean sponge, and then rinse thoroughly with clean water. Use a toothbrush or bottlebrush for hard-to-reach areas. Stubborn dirt and insects will come off more easily if the area is covered with a wet cloth for a few minutes before cleaning.

After riding in the rain, near the sea or on salt-sprayed roads

Since sea salt or salt sprayed on roads during winter are extremely corrosive in combination with water, carry out the following steps after each ride in the rain, near the sea or on salt-sprayed roads.

TIP

Salt sprayed on roads in the winter may remain well into spring.

1. Clean the motorcycle with cold water and a mild detergent, after the engine has cooled down. **NOTICE: Do not use warm water since it increases the corrosive action of the salt.** [ECA10792]
2. Apply a corrosion protection spray on all metal, including chrome- and nickel-plated, surfaces to prevent corrosion.

After cleaning

1. Dry the motorcycle with a chamois or an absorbing cloth.
2. Immediately dry the drive chain and lubricate it to prevent it from rusting.
3. Use a chrome polish to shine chrome, aluminum and stainless-steel parts, including the exhaust system. (Even the thermally induced discoloring of stainless-steel exhaust systems can be removed through polishing.)

MOTORCYCLE CARE AND STORAGE

4. To prevent corrosion, it is recommended to apply a corrosion protection spray on all metal, including chrome- and nickel-plated, surfaces.
5. Use spray oil as a universal cleaner to remove any remaining dirt.
6. Touch up minor paint damage caused by stones, etc.
7. Wax all painted surfaces.
8. Let the motorcycle dry completely before storing or covering it.

EWA11132

WARNING

Contaminants on the brakes or tires can cause loss of control.

- **Make sure that there is no oil or wax on the brakes or tires.**
- **If necessary, clean the brake discs and brake linings with a regular brake disc cleaner or acetone, and wash the tires with warm water and a mild detergent. Before riding at higher speeds, test the motorcycle's braking performance and cornering behavior.**

ECA10801

NOTICE

- **Apply spray oil and wax sparingly and make sure to wipe off any excess.**
- **Never apply oil or wax to any rubber and plastic parts, but treat them with a suitable care product.**
- **Avoid using abrasive polishing compounds as they will wear away the paint.**

TIP

- Consult a Yamaha dealer for advice on what products to use.
- Washing, rainy weather or humid climates can cause the headlight lens to fog. Turning the headlight on for a short period of time will help remove the moisture from the lens.

EAU26183

Storage

Short-term

Always store your motorcycle in a cool, dry place and, if necessary, protect it against dust with a porous cover. Be sure the engine and the exhaust system are cool before covering the motorcycle.

ECA10811

NOTICE

- **Storing the motorcycle in a poorly ventilated room or covering it with a tarp, while it is still wet, will allow water and humidity to seep in and cause rust.**
- **To prevent corrosion, avoid damp cellars, stables (because of the presence of ammonia) and areas where strong chemicals are stored.**

Long-term

Before storing your motorcycle for several months:

1. Follow all the instructions in the "Care" section of this chapter.

MOTORCYCLE CARE AND STORAGE

2. Fill up the fuel tank and add fuel stabilizer (if available) to prevent the fuel tank from rusting and the fuel from deteriorating.
3. Perform the following steps to protect the cylinders, piston rings, etc. from corrosion.
 - a. Remove the spark plug caps and spark plugs.
 - b. Pour a teaspoonful of engine oil into each spark plug bore.
 - c. Install the spark plug caps onto the spark plugs, and then place the spark plugs on the cylinder head so that the electrodes are grounded. (This will limit sparking during the next step.)
 - d. Turn the engine over several times with the starter. (This will coat the cylinder walls with oil.)
WARNING! To prevent damage or injury from sparking, make sure to ground the spark plug electrodes while turning the engine over.
 - e. Remove the spark plug caps from the spark plugs, and then install the spark plugs and the spark plug caps.
4. Lubricate all control cables and the pivoting points of all levers and pedals as well as of the side-stand/centerstand.
5. Check and, if necessary, correct the tire air pressure, and then lift the motorcycle so that both of its wheels are off the ground. Alternatively, turn the wheels a little every month in order to prevent the tires from becoming degraded in one spot.
6. Cover the muffler outlet with a plastic bag to prevent moisture from entering it.
7. Remove the battery and fully charge it. Store it in a cool, dry place and charge it once a month. Do not store the battery in an excessively cold or warm place [less than 0 °C (30 °F) or more than 30 °C (90 °F)]. For more information on storing the battery, see page 6-29.

TIP

Make any necessary repairs before storing the motorcycle.

[EWA10952]

Dimensions:

Overall length:
2085 mm (82.1 in)
Overall width:
745 mm (29.3 in)
Overall height:
1090 mm (42.9 in)
Seat height:
805 mm (31.7 in)
Wheelbase:
1400 mm (55.1 in)
Ground clearance:
140 mm (5.51 in)
Minimum turning radius:
2694 mm (106.1 in)

Weight:

Curb weight:
MT07 179 kg (395 lb)
MT07A 182 kg (401 lb)

Engine:

Engine type:
Liquid cooled 4-stroke, DOHC
Cylinder arrangement:
Inline 2-cylinder
Displacement:
689 cm³
Bore × stroke:
80.0 × 68.6 mm (3.15 × 2.70 in)
Compression ratio:
11.50 : 1
Starting system:
Electric starter
Lubrication system:
Wet sump

Engine oil:

Recommended brand:
YAMALUBE
Type:
SAE 10W-30, 10W-40, 10W-50, 15W-40,
20W-40 or 20W-50

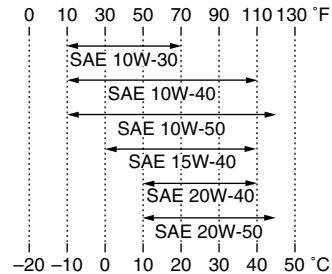

Recommended engine oil grade:
API service SG type or higher, JASO
standard MA

Engine oil quantity:
Without oil filter cartridge replacement:
2.30 L (2.43 US qt, 2.02 Imp.qt)
With oil filter cartridge replacement:
2.60 L (2.75 US qt, 2.29 Imp.qt)

Cooling system:

Coolant reservoir capacity (up to the
maximum level mark):
0.25 L (0.26 US qt, 0.22 Imp.qt)
Radiator capacity (including all routes):
1.60 L (1.69 US qt, 1.41 Imp.qt)

Air filter:

Air filter element:
Oil-coated paper element

Fuel:

Recommended fuel:
Premium unleaded gasoline (Gasohol (E10)
acceptable)
Fuel tank capacity:
14 L (3.70 US gal, 3.08 Imp.gal)
Fuel reserve amount:
2.7 L (0.71 US gal, 0.59 Imp.gal)

Fuel injection:

Throttle body:
ID mark:
MT07 1WS1 00
MT07 (35 kW) 1WS2 20
MT07A 1WS1 00
MT07A (35 kW) 1WS2 20

Spark plug(s):

Manufacturer/model:
NGK/LMAR8A-9
Spark plug gap:
0.8–0.9 mm (0.031–0.035 in)

Clutch:

Clutch type:
Wet, multiple-disc

Transmission:

Primary reduction ratio:
1.925 (77/40)
Final drive:
Chain
Secondary reduction ratio:
2.688 (43/16)
Transmission type:
Constant mesh 6-speed
Operation:
Left foot operation

SPECIFICATIONS

Gear ratio:

- 1st:
2.846 (37/13)
- 2nd:
2.125 (34/16)
- 3rd:
1.632 (31/19)
- 4th:
1.300 (26/20)
- 5th:
1.091 (24/22)
- 6th:
0.964 (27/28)

Chassis:

- Frame type:
Diamond
- Caster angle:
24.80 °
- Trail:
90 mm (3.5 in)

Front tire:

- Type:
Tubeless
- Size:
120/70 ZR17M/C (58W)
- Manufacturer/model:
MICHELIN/PILOT ROAD 3
- Manufacturer/model:
BRIDGESTONE/BT023F F

Rear tire:

- Type:
Tubeless
- Size:
180/55 ZR17M/C (73W)

- Manufacturer/model:
MICHELIN/PILOT ROAD 3A

- Manufacturer/model:
BRIDGESTONE/BT023R M

Loading:

- Maximum load:
MT07 176 kg (388 lb)
MT07A 173 kg (381 lb)
(Total weight of rider, passenger, cargo
and accessories)

Tire air pressure (measured on cold tires):

- Loading condition:
MT07 0–176 kg (0–388 lb)
MT07A 0–173 kg (0–381 lb)
- Front:
225 kPa (2.25 kgf/cm², 33 psi)
- Rear:
250 kPa (2.50 kgf/cm², 36 psi)
- High-speed riding:
Front:
225 kPa (2.25 kgf/cm², 33 psi)
Rear:
250 kPa (2.50 kgf/cm², 36 psi)

Front wheel:

- Wheel type:
Cast wheel
- Rim size:
17M/C x MT3.50

Rear wheel:

- Wheel type:
Cast wheel
- Rim size:
17M/C x MT5.50

Front brake:

- Type:
Dual disc brake
- Operation:
Right hand operation
- Specified brake fluid:
DOT 4

Rear brake:

- Type:
Single disc brake
- Operation:
Right foot operation
- Specified brake fluid:
DOT 4

Front suspension:

- Type:
Telescopic fork
- Spring/shock absorber type:
Coil spring/oil damper
- Wheel travel:
130 mm (5.1 in)

Rear suspension:

- Type:
Swingarm (link suspension)
- Spring/shock absorber type:
Coil spring/gas-oil damper
- Wheel travel:
130 mm (5.1 in)

Electrical system:

- Ignition system:
TCI
- Charging system:
AC magneto

Battery:

Model:
YTZ10S
Voltage, capacity:
12 V, 8.6 Ah

Headlight:

Bulb type:
Halogen bulb

Bulb voltage, wattage × quantity:

Headlight:
12 V, 60.0 W/55.0 W × 1

Tail/brake light:
LED

Front turn signal light:
12 V, 10.0 W × 2

Rear turn signal light:
12 V, 10.0 W × 2

Auxiliary light:
12 V, 5.0 W × 1

License plate light:
12 V, 5.0 W × 1

Meter lighting:
LED

Neutral indicator light:
LED

High beam indicator light:
LED

Oil pressure warning light:
LED

Turn signal indicator light:
LED

Coolant temperature warning light:
LED

Engine trouble warning light:
LED

ABS warning light:
MT07A LED

Immobilizer system indicator light:
LED

Fuses:

Main fuse:
30.0 A

Auxiliary fuse:
2.0 A

Headlight fuse:
15.0 A

Signaling system fuse:
10.0 A

Ignition fuse:
10.0 A

Parking lighting fuse:
7.5 A

Radiator fan fuse:
10.0 A

Fuel injection system fuse:
10.0 A

ABS control unit fuse:
MT07A 7.5 A

ABS motor fuse:
MT07A 30.0 A

ABS solenoid fuse:
MT07A 20.0 A

Backup fuse:
7.5 A

CONSUMER INFORMATION

EAU53562

Identification numbers

Record the vehicle identification number, engine serial number, and the model label information in the spaces provided below. These identification numbers are needed when registering the vehicle with the authorities in your area and when ordering spare parts from a Yamaha dealer.

VEHICLE IDENTIFICATION NUMBER:

ENGINE SERIAL NUMBER:

MODEL LABEL INFORMATION:

Vehicle identification number

EAU26401

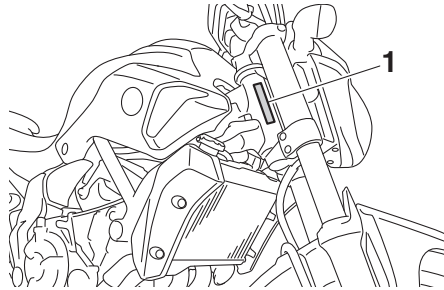

1. Vehicle identification number

The vehicle identification number is stamped into the steering head pipe. Record this number in the space provided.

TIP

The vehicle identification number is used to identify your motorcycle and may be used to register your motorcycle with the licensing authority in your area.

Engine serial number

EAU26441

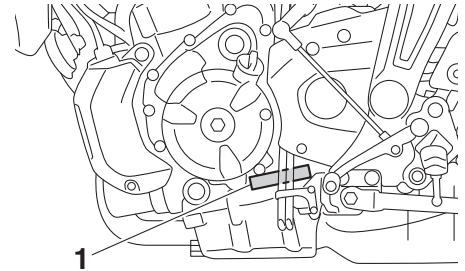

1. Engine serial number

The engine serial number is stamped into the crankcase.

Model label

EAU26521

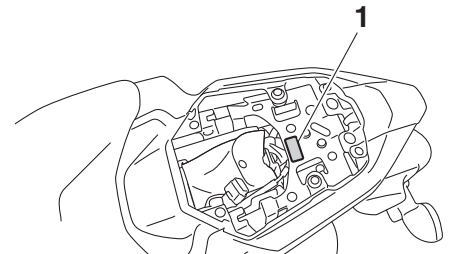

1. Model label

CONSUMER INFORMATION

The model label is affixed to the frame under the passenger seat. (See page 3-19.) Record the information on this label in the space provided. This information will be needed when ordering spare parts from a Yamaha dealer.

INDEX

A

- ABS (for ABS models).....3-15
- ABS warning light (for ABS models)3-5
- Air filter element and check hose,
replacing and cleaning6-14
- Auxiliary DC connector3-27
- Auxiliary light bulb, replacing.....6-36

B

- Battery6-29
- Brake and clutch levers,
checking and lubricating6-26
- Brake and shift pedals,
checking and lubricating6-25
- Brake fluid, changing6-22
- Brake fluid level, checking6-21
- Brake lever3-14
- Brake lever free play, checking.....6-19
- Brake light switches.....6-19
- Brake pedal.....3-15

C

- Cables, checking and lubricating6-25
- Care7-1
- Catalytic converter.....3-19
- Clutch lever.....3-14
- Clutch lever free play, adjusting6-18
- Coolant6-11
- Coolant temperature warning light3-4

D

- Dimmer switch3-13
- Drive chain, cleaning and lubricating...6-24
- Drive chain slack.....6-22

E

- Engine break-in.....5-3
- Engine oil and oil filter cartridge6-9

- Engine serial number.....9-1
- Engine trouble warning light.....3-4

F

- Front and rear brake pads, checking ... 6-20
- Front fork, checking6-28
- Fuel.....3-17
- Fuel consumption, tips for reducing5-3
- Fuel tank breather hose and overflow
hose3-18
- Fuel tank cap.....3-16
- Fuses, replacing6-31

H

- Handlebar switches.....3-13
- Hazard switch.....3-13
- Headlight bulb, replacing6-32
- Helmet holding cable3-21
- High beam indicator light3-4
- Horn switch3-13

I

- Identification numbers.....9-1
- Ignition circuit cut-off system.....3-25
- Immobilizer system3-1
- Immobilizer system indicator light.....3-5
- Indicator lights and warning lights3-3

L

- License plate light bulb, replacing.....6-35
- Luggage strap holders3-24

M

- Main switch/steering lock.....3-2
- Maintenance and lubrication, periodic...6-4
- Maintenance, emission control
system.....6-3
- Matte color, caution7-1
- Model label.....9-1

- Multi-function meter unit.....3-6

N

- Neutral indicator light.....3-4

O

- Oil pressure warning light3-4

P

- Parking5-4
- Part locations2-1
- Pass switch3-13

R

- Rear suspension, lubricating6-27

S

- Safety information.....1-1
- Seats3-19
- Shifting.....5-2
- Shift pedal.....3-14
- Shock absorber assembly, adjusting...3-23
- Sidestand3-24
- Sidestand, checking and lubricating.....6-27
- Spark plugs, checking6-8
- Specifications8-1
- Start/Engine stop switch.....3-13
- Starting the engine.....5-1
- Steering, checking6-28
- Storage7-3
- Storage compartment.....3-22
- Supporting the motorcycle6-36
- Swingarm pivots, lubricating6-27

T

- Tail/brake light6-34
- Throttle grip and cable,
checking and lubricating6-25
- Throttle grip free play, checking6-15
- Tires6-15

Tool kit.....	6-2
Troubleshooting.....	6-41
Troubleshooting charts.....	6-42
Turn signal indicator lights	3-3
Turn signal light bulb, replacing	6-34
Turn signal switch.....	3-13
V	
Valve clearance	6-15
Vehicle identification number	9-1
W	
Wheel bearings, checking	6-29
Wheel, front (for non-ABS models).....	6-37
Wheel, rear (for non-ABS models).....	6-39
Wheels.....	6-18

