



⚠ Read this manual carefully before operating this vehicle.

OWNER'S MANUAL



CW50
CW50L
CW50N

2B6-F8199-E1

 **Read this manual carefully before operating this vehicle. This manual should stay with this vehicle if it is sold.**

Welcome to the Yamaha world of motorcycling!

As the owner of the CW50/CW50L/CW50N, you are benefiting from Yamaha's vast experience and newest technology regarding the design and manufacture of high-quality products, which have earned Yamaha a reputation for dependability. Please take the time to read this manual thoroughly, so as to enjoy all advantages of your CW50/CW50L/CW50N. The Owner's Manual does not only instruct you in how to operate, inspect and maintain your scooter, but also in how to safeguard yourself and others from trouble and injury.

In addition, the many tips given in this manual will help keep your scooter in the best possible condition. If you have any further questions, do not hesitate to contact your Yamaha dealer.

The Yamaha team wishes you many safe and pleasant rides. So, remember to put safety first!

Yamaha continually seeks advancements in product design and quality. Therefore, while this manual contains the most current product information available at the time of printing, there may be minor discrepancies between your scooter and this manual. If there is any question concerning this manual, please consult a Yamaha dealer.



Please read this manual carefully and completely before operating this scooter.







- TIP**
-
- This mark identifies the recommended fuel for this vehicle as specified by European regulation (EN228).
 - Check that gasoline nozzle has the same identifier when fueling.
-

IMPORTANT MANUAL INFORMATION

EAU10133

Particularly important information is distinguished in this manual by the following notations:

| | |
|--|---|
|  | This is the safety alert symbol. It is used to alert you to potential personal injury hazards. Obey all safety messages that follow this symbol to avoid possible injury or death. |
|  | A WARNING indicates a hazardous situation which, if not avoided, could result in death or serious injury. |
|  | A NOTICE indicates special precautions that must be taken to avoid damage to the vehicle or other property. |
|  | A TIP provides key information to make procedures easier or clearer. |

*Product and specifications are subject to change without notice.

IMPORTANT MANUAL INFORMATION

EAUM1011

**CW50/CW50L/CW50N
OWNER'S MANUAL
©2012 by MBK INDUSTRIE
1st edition, October 2012
All rights reserved
Any reprinting or unauthorized use
without the written permission of
MBK INDUSTRIE
is expressly prohibited.
Printed in France.**

TABLE OF CONTENTS

| | | | | | |
|--|------|---|------|---|------|
| SAFETY INFORMATION | 1-1 | Luggage hook | 3-11 | Cast wheels | 6-13 |
| Further safe-riding points | 1-5 | | | Checking the front brake lever free play | 6-13 |
| DESCRIPTION | 2-1 | FOR YOUR SAFETY – | | Adjusting the rear brake lever free play | 6-13 |
| Left view | 2-1 | PRE-OPERATION CHECKS | 4-1 | Checking the front brake pads and rear brake shoes | 6-14 |
| Right view | 2-2 | | | Checking the brake fluid level | 6-15 |
| INSTRUMENT AND CONTROL | | OPERATION AND IMPORTANT | | Changing the brake fluid | 6-16 |
| FUNCTIONS | 3-1 | RIDING POINTS | 5-1 | Checking and lubricating the cables | 6-16 |
| Main switch/steering lock | 3-1 | Starting a cold engine | 5-1 | Checking and lubricating the throttle grip and cable | 6-16 |
| Indicator lights and warning lights | 3-2 | Starting off | 5-2 | Lubricating the front and rear brake levers | 6-17 |
| Speedometer unit (CW50/CW50L) | 3-3 | Acceleration and deceleration | 5-2 | Checking and lubricating the centerstand | 6-17 |
| Speedometer unit (CW50N) | 3-4 | Braking | 5-3 | Checking the front fork | 6-18 |
| Fuel gauge (CW50/CW50L) | 3-4 | Tips for reducing fuel consumption | 5-3 | Checking the steering | 6-19 |
| Handlebar switches | 3-5 | Engine break-in | 5-4 | Checking the wheel bearings | 6-19 |
| Front brake lever | 3-5 | Parking | 5-4 | Battery | 6-19 |
| Rear brake lever | 3-6 | | | Replacing the fuse | 6-21 |
| Fuel and 2-stroke engine oil tank caps | 3-6 | PERIODIC MAINTENANCE AND | | Replacing a headlight bulb | 6-22 |
| Fuel | 3-7 | ADJUSTMENT | 6-1 | Replacing the tail/brake light bulb | 6-22 |
| Catalytic converter | 3-8 | Periodic maintenance chart for the emission control system | 6-2 | Replacing a turn signal light bulb | 6-23 |
| 2-stroke engine oil | 3-8 | General maintenance and lubrication chart | 6-3 | Troubleshooting | 6-23 |
| Kickstarter | 3-9 | Removing and installing the cowling and panels | 6-6 | Troubleshooting chart | 6-24 |
| Securing bracket | 3-9 | Checking the spark plug | 6-7 | | |
| Seat | 3-9 | Final transmission oil | 6-8 | | |
| Anti-theft device housing | 3-10 | Cleaning the air filter element | 6-9 | | |
| Adjusting the shock absorber assembly (CW50L model only) | 3-10 | Adjusting the carburetor | 6-10 | | |
| | | Checking the throttle grip free play | 6-10 | | |
| | | Tires | 6-10 | | |

TABLE OF CONTENTS

| | |
|-------------------------------------|-----|
| SCOOTER CARE AND STORAGE ... | 7-1 |
| Matte color caution | 7-1 |
| Care | 7-1 |
| Storage | 7-3 |
| SPECIFICATIONS | 8-1 |
| CONSUMER INFORMATION | 9-1 |
| Identification numbers | 9-1 |

SAFETY INFORMATION

EAUT1018

1

Be a Responsible Owner

As the vehicle's owner, you are responsible for the safe and proper operation of your scooter.

Scooters are single-track vehicles.

Their safe use and operation are dependent upon the use of proper riding techniques as well as the expertise of the operator. Every operator should know the following requirements before riding this scooter.

He or she should:

- Obtain thorough instructions from a competent source on all aspects of scooter operation.
- Observe the warnings and maintenance requirements in this Owner's Manual.
- Obtain qualified training in safe and proper riding techniques.
- Obtain professional technical service as indicated in this Owner's Manual and/or when made necessary by mechanical conditions.

- Never operate a scooter without proper training or instruction. Take a training course. Beginners should receive training from a certified instructor. Contact an authorized scooter dealer to find out about the training courses nearest you.

Safe Riding

Perform the pre-operation checks each time you use the vehicle to make sure it is in safe operating condition. Failure to inspect or maintain the vehicle properly increases the possibility of an accident or equipment damage. See page 4-1 for a list of pre-operation checks.

- This scooter is designed to carry the operator and a passenger.

TIP

Although this scooter is designed to carry a passenger, always comply with the local regulations.

- The failure of motorists to detect and recognize scooters in traffic is the predominating cause of automobile/scooter accidents. Many accidents have been caused by an

automobile driver who did not see the scooter. Making yourself conspicuous appears to be very effective in reducing the chance of this type of accident.

Therefore:

- Wear a brightly colored jacket.
- Use extra caution when you are approaching and passing through intersections, since intersections are the most likely places for scooter accidents to occur.
- Ride where other motorists can see you. Avoid riding in another motorist's blind spot.
- Never maintain a scooter without proper knowledge. Contact an authorized scooter dealer to inform you on basic scooter maintenance. Certain maintenance can only be carried out by certified staff.

- Many accidents involve inexperienced operators. In fact, many operators who have been involved in accidents do not even have a current driver's license.
 - Make sure that you are qualified and that you only lend your scooter to other qualified operators.
 - Know your skills and limits. Staying within your limits may help you to avoid an accident.
 - We recommend that you practice riding your scooter where there is no traffic until you have become thoroughly familiar with the scooter and all of its controls.
- Many accidents have been caused by error of the scooter operator. A typical error made by the operator is veering wide on a turn due to excessive speed or undercornering (insufficient lean angle for the speed).
 - Always obey the speed limit and never travel faster than warranted by road and traffic conditions.
- Always signal before turning or changing lanes. Make sure that other motorists can see you.
- The posture of the operator and passenger is important for proper control.
 - The operator should keep both hands on the handlebar and both feet on the operator footrests during operation to maintain control of the scooter.
 - The passenger should always hold onto the operator, the seat strap or grab bar, if equipped, with both hands and keep both feet on the passenger footrests. Never carry a passenger unless he or she can firmly place both feet on the passenger footrests.
- Never ride under the influence of alcohol or other drugs.
- This scooter is designed for on-road use only. It is not suitable for off-road use.

Protective Apparel

The majority of fatalities from scooter accidents are the result of head injuries. The use of a safety helmet is the single most critical factor in the prevention or reduction of head injuries.

- Always wear an approved helmet.
- Wear a face shield or goggles. Wind in your unprotected eyes could contribute to an impairment of vision that could delay seeing a hazard.
- The use of a jacket, substantial shoes, trousers, gloves, etc., is effective in preventing or reducing abrasions or lacerations.
- Never wear loose-fitting clothes, otherwise they could catch on the control levers or wheels and cause injury or an accident.
- Always wear protective clothing that covers your legs, ankles, and feet. The engine or exhaust system become very hot during or after operation and can cause burns.
- A passenger should also observe the above precautions.

SAFETY INFORMATION

1

Avoid Carbon Monoxide Poisoning

All engine exhaust contains carbon monoxide, a deadly gas. Breathing carbon monoxide can cause headaches, dizziness, drowsiness, nausea, confusion, and eventually death.

Carbon Monoxide is a colorless, odorless, tasteless gas which may be present even if you do not see or smell any engine exhaust. Deadly levels of carbon monoxide can collect rapidly and you can quickly be overcome and unable to save yourself. Also, deadly levels of carbon monoxide can linger for hours or days in enclosed or poorly ventilated areas. If you experience any symptoms of carbon monoxide poisoning, leave the area immediately, get fresh air, and **SEEK MEDICAL TREATMENT**.

- Do not run engine indoors. Even if you try to ventilate engine exhaust with fans or open windows and doors, carbon monoxide can rapidly reach dangerous levels.
- Do not run engine in poorly ventilated or partially enclosed areas such as barns, garages, or carports.

- Do not run engine outdoors where engine exhaust can be drawn into a building through openings such as windows and doors.

Loading

Adding accessories or cargo to your scooter can adversely affect stability and handling if the weight distribution of the scooter is changed. To avoid the possibility of an accident, use extreme caution when adding cargo or accessories to your scooter. Use extra care when riding a scooter that has added cargo or accessories. Here, along with the information about accessories below, are some general guidelines to follow if loading cargo to your scooter:

The total weight of the operator, passenger, accessories and cargo must not exceed the maximum load limit.

Operation of an overloaded vehicle could cause an accident.

| |
|---|
| Maximum load: 185 kg (408 lb) |
|---|

When loading within this weight limit, keep the following in mind:

- Cargo and accessory weight should be kept as low and close to the scooter as possible. Securely pack your heaviest items as close to the center of the vehicle as possible and make sure to distribute the weight as evenly as possible on both sides of the scooter to minimize imbalance or instability.
- Shifting weights can create a sudden imbalance. Make sure that accessories and cargo are securely attached to the scooter before riding. Check accessory mounts and cargo restraints frequently.
 - Properly adjust the suspension for your load (suspension-adjustable models only), and check the condition and pressure of your tires.
 - Never attach any large or heavy items to the handlebar, front fork, or front fender. Such items can create unstable handling or a slow steering response.
- **This vehicle is not designed to pull a trailer or to be attached to a sidecar.**

Genuine Yamaha Accessories

Choosing accessories for your vehicle is an important decision. Genuine Yamaha accessories, which are available only from a Yamaha dealer, have been designed, tested, and approved by Yamaha for use on your vehicle.

Many companies with no connection to Yamaha manufacture parts and accessories or offer other modifications for Yamaha vehicles. Yamaha is not in a position to test the products that these aftermarket companies produce. Therefore, Yamaha can neither endorse nor recommend the use of accessories not sold by Yamaha or modifications not specifically recommended by Yamaha, even if sold and installed by a Yamaha dealer.

Aftermarket Parts, Accessories, and Modifications

While you may find aftermarket products similar in design and quality to genuine Yamaha accessories, recognize that some aftermarket accessories or modifications are not suitable because of potential safety hazards to you or others. Installing aftermarket prod-

ucts or having other modifications performed to your vehicle that change any of the vehicle's design or operation characteristics can put you and others at greater risk of serious injury or death. You are responsible for injuries related to changes in the vehicle.

Keep the following guidelines in mind, as well as those provided under "Loading" when mounting accessories.

- Never install accessories or carry cargo that would impair the performance of your scooter. Carefully inspect the accessory before using it to make sure that it does not in any way reduce ground clearance or cornering clearance, limit suspension travel, steering travel or control operation, or obscure lights or reflectors.
- Accessories fitted to the handlebar or the front fork area can create instability due to improper weight distribution or aerodynamic changes. If accessories are added to the handlebar or front fork area, they must be as lightweight as possible and should be kept to a minimum.
- Bulky or large accessories may seriously affect the stability of the scooter due to aerodynamic effects. Wind may attempt to lift the scooter, or the scooter may become unstable in cross winds. These accessories may also cause instability when passing or being passed by large vehicles.
- Certain accessories can displace the operator from his or her normal riding position. This improper position limits the freedom of movement of the operator and may limit control ability, therefore, such accessories are not recommended.
- Use caution when adding electrical accessories. If electrical accessories exceed the capacity of the scooter's electrical system, an electric failure could result, which could cause a dangerous loss of lights or engine power.

SAFETY INFORMATION

1

Aftermarket Tires and Rims

The tires and rims that came with your scooter were designed to match the performance capabilities and to provide the best combination of handling, braking, and comfort. Other tires, rims, sizes, and combinations may not be appropriate. Refer to page 6-10 for tire specifications and more information on replacing your tires.

Transporting the Scooter

Be sure to observe following instructions before transporting the scooter in another vehicle.

- Remove all loose items from the scooter.
- Point the front wheel straight ahead on the trailer or in the truck bed, and choke it in a rail to prevent movement.
- Secure the scooter with tie-downs or suitable straps that are attached to solid parts of the scooter, such as the frame or upper front fork triple clamp (and not, for example, to rubber-mounted handlebars or turn signals, or parts that could break). Choose the location for the

straps carefully so the straps will not rub against painted surfaces during transport.

- The suspension should be compressed somewhat by the tie-downs, if possible, so that the scooter will not bounce excessively during transport.

EAU10373

Further safe-riding points

- Be sure to signal clearly when making turns.
- Braking can be extremely difficult on a wet road. Avoid hard braking, because the scooter could slide. Apply the brakes slowly when stopping on a wet surface.
- Slow down as you approach a corner or turn. Once you have completed a turn, accelerate slowly.
- Be careful when passing parked cars. A driver might not see you and open a door in your path.
- Railroad crossings, streetcar rails, iron plates on road construction sites, and manhole covers become extremely slippery when wet. Slow down and cross them with caution. Keep the scooter upright, otherwise it could slide out from under you.
- The brake pads could get wet when you wash the scooter. After washing the scooter, check the brakes before riding.

- Always wear a helmet, gloves, trousers (tapered around the cuff and ankle so they do not flap), and a bright colored jacket.
- Do not carry too much luggage on the scooter. An overloaded scooter is unstable. Use a strong cord to secure any luggage to the carrier (if equipped). A loose load will affect the stability of the scooter and could divert your attention from the road. (See page 1-3.)

DESCRIPTION

EAU10410

Left view

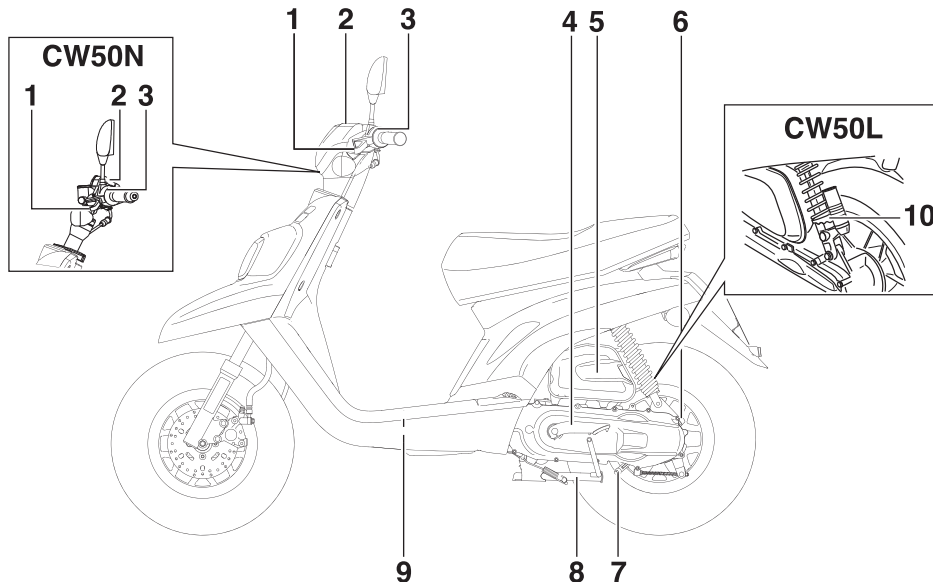

1. Rear brake lever (page 3-6)
2. Speedometer unit (page 3-3)
3. Left handlebar switches (page 3-5)
4. Kickstarter (page 3-9)
5. Air filter element (page 6-9)
6. Final transmission oil filler cap (page 6-8)
7. Final transmission oil drain bolt (page 6-8)
8. Centerstand (page 6-17)

9. Battery/fuse (page 6-19/6-21)
10. Shock absorber assembly spring preload adjusting ring (page 3-10)

Right view

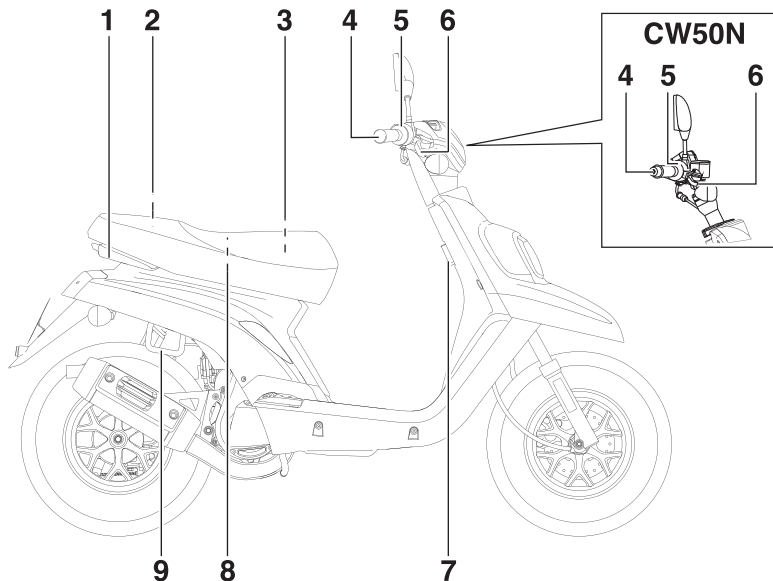

1. Grab bar (page 5-2)
2. Oil tank cap (page 3-8)
3. Fuel tank cap (page 3-6)
4. Throttle grip (page 6-10)
5. Right handlebar switch (page 3-5)
6. Front brake lever (page 3-5)
7. Luggage hook (page 3-11)
8. Anti-theft device housing (page 3-10)

9. Securing bracket (page 3-9)

INSTRUMENT AND CONTROL FUNCTIONS

Main switch/steering lock

EAU10461

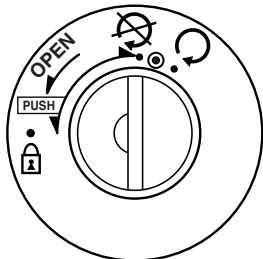

ZAU00253

The main switch/steering lock controls the ignition and lighting systems, and is used to lock the steering. The various positions are described below.

ON “○”

EAU10640

All electrical circuits are supplied with power, and the engine can be started. The key cannot be removed.

TIP

The headlight, meter lighting and tail-light come on automatically when the engine is started.

OFF “⊗”

EAU10661

All electrical systems are off. The key can be removed.

EWA10061

! WARNING

Never turn the key to “⊗” or “⊔” while the vehicle is moving. Otherwise the electrical systems will be switched off, which may result in loss of control or an accident.

CHECK “⊙” (CW50/CW50L)

EAU10670

The 2-stroke engine oil level warning light should come on. (See page 3-2.)

CHECK “⊙” (CW50N)

EAUM2920

The 2-stroke engine oil level warning light and the fuel level warning light should come on. (See page 3-2.)

LOCK “⊔”

EAU10684

The steering is locked, and all electrical systems are off. The key can be removed.

To lock the steering

1. Turn the handlebars all the way to the left.
2. Push the key in from the “⊗” position, and then turn it to “⊔” while still pushing it.
3. Remove the key.

To unlock the steering

Push the key in, and then turn it to “⊗” while still pushing it.

INSTRUMENT AND CONTROL FUNCTIONS

Indicator lights and warning lights

CW50/CW50L

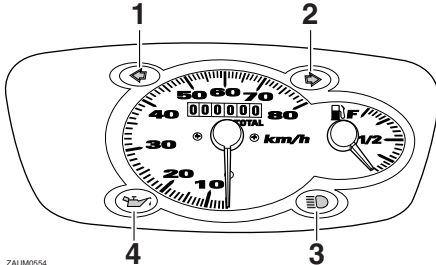

ZAUM0554

1. Left turn signal indicator light “”
2. Right turn signal indicator light “”
3. High beam indicator light “”
4. Oil level warning light “”

EAU49392

CW50N

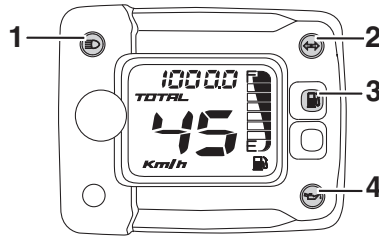

ZAUM0962

1. High beam indicator light “”
2. Turn signal indicator light “ ”
3. Fuel level warning light “”
4. Oil level warning light “”

Turn signal indicator lights “” and “” (CW50/CW50L)

EAU11030

The corresponding indicator light flashes when the turn signal switch is pushed to the left or right.

Turn signal indicator light “ ” (CW50N)

EAU11020

This indicator light flashes when the turn signal switch is pushed to the left or right.

High beam indicator light “”

EAU11080

This indicator light comes on when the high beam of the headlight is switched on.

Oil level warning light “”

EAU11181

This warning light comes on when the key is in the “” position or if the oil level in the 2-stroke engine oil tank is low during operation. If the warning light comes on during operation, stop immediately and fill the oil tank with Yamalube 2 or equivalent 2-stroke engine oil of either JASO grade “FC” or ISO grades “EG-C” or “EG-D”. The warning light should go off after the 2-stroke engine oil tank has been refilled.

TIP

If the warning light does not come on when the key is in the “” position or does not go off after the 2-stroke engine oil tank has been refilled, have a Yamaha dealer check the electrical circuit.

INSTRUMENT AND CONTROL FUNCTIONS

NOTICE

ECA16291

Do not operate the vehicle until you know that the engine oil level is sufficient.

EAM2910

Fuel level warning light “A line drawing of a motorcycle instrument cluster. The digital display shows '10000 F' at the top, 'TOTAL' below it, and a large '45' in the center. Below the '45' is 'Km/h' and a fuel tank icon with a lightning bolt through it, indicating the warning light is on. There are several indicator lights around the cluster, including a battery light, a headlight indicator, and a neutral indicator.

ZAUM0963

This warning light comes on when only the last two segments of the fuel meter are displayed, approximately 1.5 L (0.40 US gal, 0.33 Imp.gal) of fuel remains in the fuel tank. If this occurs, refuel as soon as possible.

TIP

- Do not allow the fuel tank to empty itself completely.

- The last segment of the fuel meter and the fuel symbol will flash when the fuel tank is nearly empty.
- The electrical circuit of the warning light can be checked as follows.

Turn the key to “

Speedometer unit (CW50/CW50L)

EAU11621

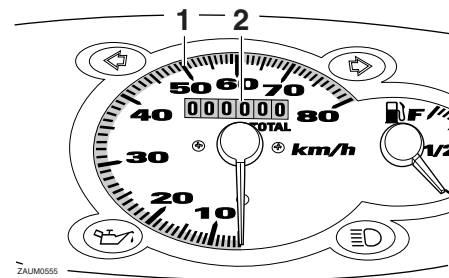

ZAUM0555

1. Speedometer
2. Odometer

UK ONLY

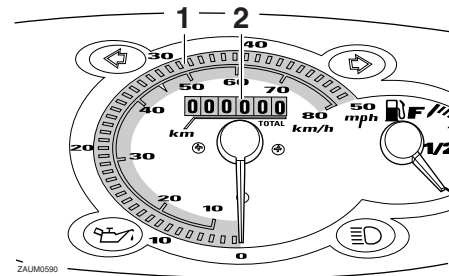

ZAUM0590

1. Speedometer
2. Odometer

INSTRUMENT AND CONTROL FUNCTIONS

The speedometer unit is equipped with a speedometer and an odometer. The speedometer shows riding speed. The odometer shows the total distance traveled.

Speedometer unit (CW50N) EAUM1590

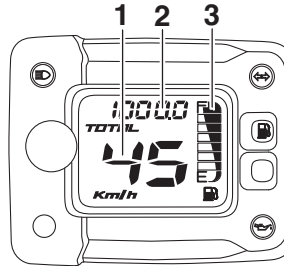

ZAUIM0964

1. Speedometer
2. Odometer
3. Fuel meter

The speedometer unit is equipped with a speedometer, an odometer and a fuel meter. The speedometer shows riding speed. The odometer shows the total distance traveled. The fuel meter indicates the amount of fuel in the fuel tank. (See page 3-2 for an explanation of the fuel level warning light.)

Fuel gauge (CW50/CW50L) EAU12111

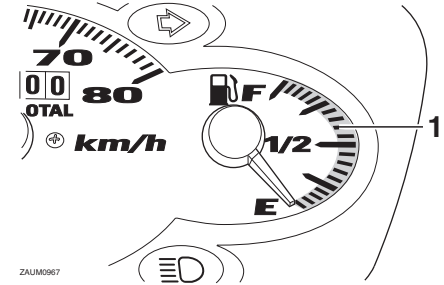

ZAUIM0967

1. Fuel gauge

The fuel gauge indicates the amount of fuel in the fuel tank. The needle moves towards "E" (Empty) as the fuel level decreases. When the needle reaches "E", approximately 1.2 L (0.32 US gal, 0.26 Imp.gal) of fuel remain in the fuel tank. If this occurs, refuel as soon as possible.



INSTRUMENT AND CONTROL FUNCTIONS

Handlebar switches

EAU1234B

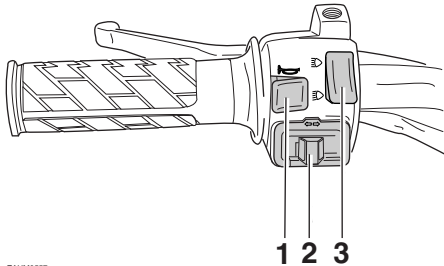
Left



- ZALUM0557
1. Horn switch “”
 2. Turn signal switch “”
 3. Dimmer switch “”

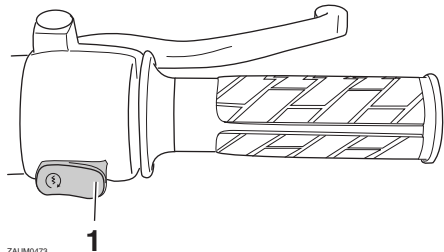

Right



- ZALUM0473
1. Start switch “”



Dimmer switch “”

EAU12400

Set this switch to “” for the high beam and to “” for the low beam.

Turn signal switch “”

EAU12460

To signal a right-hand turn, push this switch to “”. To signal a left-hand turn, push this switch to “”. When released, the switch returns to the center position. To cancel the turn signal lights, push the switch in after it has returned to the center position.

Horn switch “”

EAU12500

Press this switch to sound the horn.

Start switch “”

EAUM1132

Push this switch while applying the front or rear brake to crank the engine with the starter. See page 5-1 for starting instructions prior to starting the engine.

Front brake lever

EAU12901

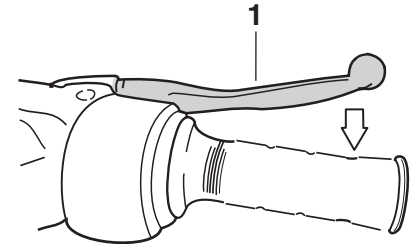

ZALUM0791

1. Front brake lever

The front brake lever is located on the right side of the handlebar. To apply the front brake, pull this lever toward the throttle grip.

Rear brake lever

EAU12951

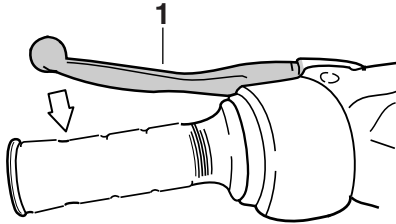

ZALUM0085

1. Rear brake lever

The rear brake lever is located on the left side of the handlebar. To apply the rear brake, pull this lever toward the handlebar grip.

Fuel and 2-stroke engine oil tank caps

EAU13202

The fuel tank cap and the 2-stroke engine oil tank cap are located under the seat. (See page 3-9.)

Fuel tank cap

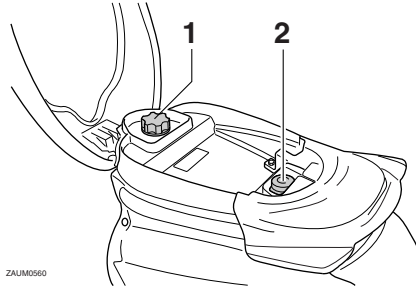

ZALUM0560

1. Fuel tank cap
2. 2-stroke engine oil tank cap

To remove the fuel tank cap, turn it counterclockwise, and then pull it off.

To install the fuel tank cap, turn it clockwise.

2-stroke engine oil tank cap

To remove the 2-stroke engine oil tank cap, pull it off.

To install the 2-stroke engine oil tank cap, push it into the oil tank opening.

EWA10141

WARNING

Make sure that the fuel and 2-stroke engine oil tank caps are properly installed before riding the scooter. Leaking fuel is a fire hazard.

INSTRUMENT AND CONTROL FUNCTIONS

Fuel

EAU13212

Make sure there is sufficient gasoline in the tank.

EWA10881

WARNING

Gasoline and gasoline vapors are extremely flammable. To avoid fires and explosions and to reduce the risk of injury when refueling, follow these instructions.

1. Before refueling, turn off the engine and be sure that no one is sitting on the vehicle. Never refuel while smoking, or while in the vicinity of sparks, open flames, or other sources of ignition such as the pilot lights of water heaters and clothes dryers.
2. Do not overfill the fuel tank. Stop filling when the fuel reaches the bottom of the filler tube. Because fuel expands when it heats up, heat from the engine or the sun can cause fuel to spill out of the fuel tank.

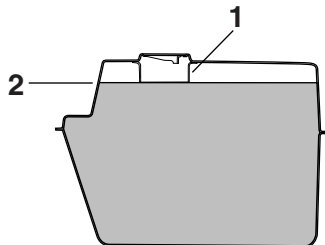

ZAJM0020

1. Fuel tank filler tube
2. Maximum fuel level
3. Wipe up any spilled fuel immediately. **NOTICE: Immediately wipe off spilled fuel with a clean, dry, soft cloth, since fuel may deteriorate painted surfaces or plastic parts.** (ECA10071)
4. Be sure to securely close the fuel tank cap.

EWA15151

WARNING

Gasoline is poisonous and can cause injury or death. Handle gasoline with care. Never siphon gasoline by mouth. If you should swallow some gasoline or inhale a lot of gasoline vapor, or get some gasoline in your eyes, see your doctor immedi-

ately. If gasoline spills on your skin, wash with soap and water. If gasoline spills on your clothing, change your clothes.

EAUM2730

Recommended fuel:

Premium unleaded gasoline only

Fuel tank capacity:

5.3 L (1.40 US gal, 1.17 Imp.gal)

Fuel reserve amount (when the fuel level warning light comes on):

CW50 1.2 L (0.32 US gal,
0.26 Imp.gal)

CW50L 1.2 L (0.32 US gal,
0.26 Imp.gal)

CW50N 1.5 L (0.40 US gal,
0.33 Imp.gal)

Your Yamaha engine has been designed to use premium unleaded gasoline with a research octane number of 95 or higher. If knocking (or pinging) occurs, use a gasoline of a different brand. Use of unleaded fuel will extend spark plug life and reduce maintenance costs.

Catalytic converter

EAU13433

This model is equipped with a catalytic converter in the exhaust system.

EWA10862



The exhaust system is hot after operation. To prevent a fire hazard or burns:

- Do not park the vehicle near possible fire hazards such as grass or other materials that easily burn.
- Park the vehicle in a place where pedestrians or children are not likely to touch the hot exhaust system.
- Make sure that the exhaust system has cooled down before doing any maintenance work.
- Do not allow the engine to idle more than a few minutes. Long idling can cause a build-up of heat.

NOTICE

Use only unleaded gasoline. The use of leaded gasoline will cause unrepairable damage to the catalytic converter.

ECA10701

2-stroke engine oil

EAU13453

Make sure that there is sufficient 2-stroke engine oil in the oil tank. Add the recommended 2-stroke engine oil as necessary.

Recommended oil:

See page 8-1.

Oil quantity:

1.10 L (1.16 US qt, 0.97 Imp.qt)

ECA16670

NOTICE

Make sure that the 2-stroke engine oil tank cap is properly installed.

INSTRUMENT AND CONTROL FUNCTIONS

Kickstarter

EAUS1050

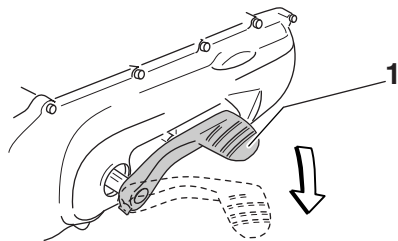

ZALUM0146

1. Kickstarter

To start the engine, push the kickstarter down lightly with your foot until the gears engage, and then push it down smoothly but forcefully.

Securing bracket

EAUT1040

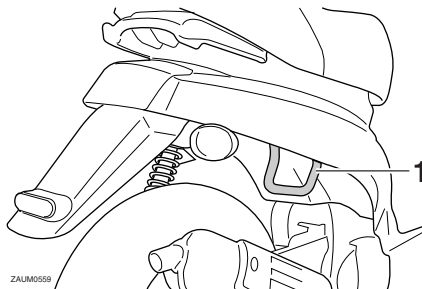

ZALUM0559

1. Securing bracket

To prevent theft, the securing bracket can be used to chain the scooter to a stationary object such as a lamppost or a fence.

To secure the scooter with a chain or cable lock, place the scooter on the centerstand, pass the chain or cable through the securing bracket and around the stationary object, and then lock the chain or cable lock.

EWAT1020



WARNING

Be sure to remove the chain or cable before riding, otherwise the scooter may overturn, causing damage or injury.

Seat

EAU13932

To open the seat

1. Place the scooter on the centerstand.
2. Insert the key into the main switch, and then turn it counterclockwise to "OPEN".

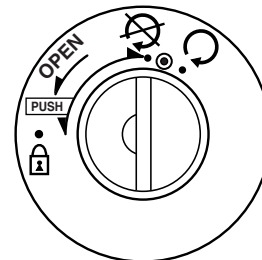

ZALUM0253

TIP

Do not push inward when turning the key.

3. Fold the seat up.

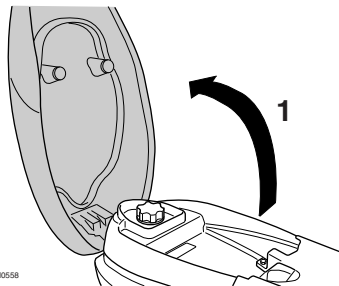

ZALUM0558

1. Open.

To close the seat

1. Fold the seat down, and then push it down to lock it in place.
2. Remove the key from the main switch if the scooter will be left unattended.

TIP

Make sure that the seat is properly secured before riding.

Anti-theft device housing

EAUM1580

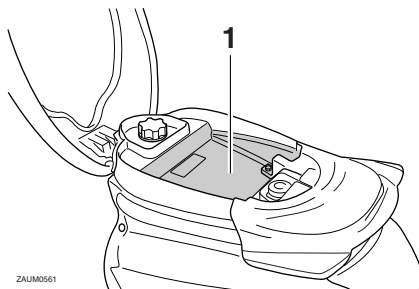

ZALUM0561

1. Anti-theft device housing

The anti-theft device housing, located under the seat, is designed to store a joint type anti-theft device with a maximum length of 1 meter. (See page 3-9 for seat opening and closing procedures.)

TIP

Some anti-theft devices cannot fit into the housing due to their size or shape.

Adjusting the shock absorber assembly (CW50L model only)

EAU14833

This shock absorber assembly is equipped with a spring preload adjusting ring.

ECA10101

NOTICE

To avoid damaging the mechanism, do not attempt to turn beyond the maximum or minimum settings.

Adjust the spring preload as follows.

To increase the spring preload and thereby harden the suspension, turn the adjusting ring in direction (a). To decrease the spring preload and thereby soften the suspension, turn the adjusting ring in direction (b).

INSTRUMENT AND CONTROL FUNCTIONS

EWA10221

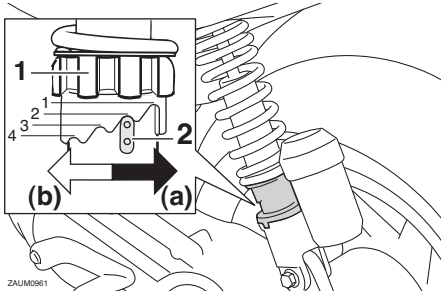

1. Spring preload adjusting ring
2. Position indicator

Align the appropriate notch in the adjusting ring with the position indicator on the shock absorber.

Spring preload setting:

Minimum (soft):

1

Standard:

2

Maximum (hard):

4

WARNING

This shock absorber assembly contains highly pressurized nitrogen gas. Read and understand the following information before handling the shock absorber assembly.

- Do not tamper with or attempt to open the cylinder assembly.
- Do not subject the shock absorber assembly to an open flame or other high heat source. This may cause the unit to explode due to excessive gas pressure.
- Do not deform or damage the cylinder in any way. Cylinder damage will result in poor damping performance.
- Do not dispose of a damaged or worn-out shock absorber assembly yourself. Take the shock absorber assembly to a Yamaha dealer for any service.

Luggage hook

EAUT1072

WARNING

EWAT1031

- Do not exceed the load limit of 3 kg (6.6 lb) for the luggage hook.
- Do not exceed the maximum load of 185 kg (408 lb) for the vehicle.

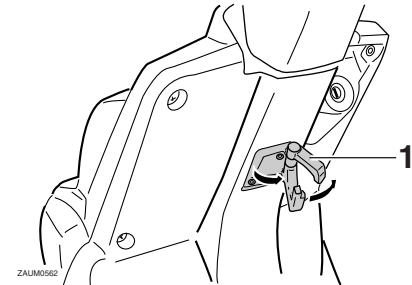

1. Luggage hook

FOR YOUR SAFETY – PRE-OPERATION CHECKS

EAU15597

Inspect your vehicle each time you use it to make sure the vehicle is in safe operating condition. Always follow the inspection and maintenance procedures and schedules described in the Owner's Manual.

EWA11151

WARNING

Failure to inspect or maintain the vehicle properly increases the possibility of an accident or equipment damage. Do not operate the vehicle if you find any problem. If a problem cannot be corrected by the procedures provided in this manual, have the vehicle inspected by a Yamaha dealer.

Before using this vehicle, check the following points:

| ITEM | CHECKS | PAGE |
|------------------------|---|------------|
| Fuel | <ul style="list-style-type: none">• Check fuel level in fuel tank.• Refuel if necessary.• Check fuel line for leakage. | 3-7 |
| 2-stroke engine oil | <ul style="list-style-type: none">• Check oil level in oil tank.• If necessary, add recommended oil to specified level.• Check vehicle for oil leakage. | 3-8 |
| Final transmission oil | <ul style="list-style-type: none">• Check vehicle for oil leakage. | 6-8 |
| Front brake | <ul style="list-style-type: none">• Check operation.• If soft or spongy, have Yamaha dealer bleed hydraulic system.• Check brake pads for wear.• Replace if necessary.• Check fluid level in reservoir.• If necessary, add specified brake fluid to specified level.• Check hydraulic system for leakage. | 6-14, 6-15 |
| Rear brake | <ul style="list-style-type: none">• Check operation.• Lubricate cable if necessary.• Check lever free play.• Adjust if necessary. | 6-13, 6-14 |

FOR YOUR SAFETY – PRE-OPERATION CHECKS

| ITEM | CHECKS | PAGE |
|--|--|------------|
| Throttle grip | <ul style="list-style-type: none"> • Make sure that operation is smooth. • Check throttle grip free play. • If necessary, have Yamaha dealer adjust throttle grip free play and lubricate cable and grip housing. | 6-10, 6-16 |
| Wheels and tires | <ul style="list-style-type: none"> • Check for damage. • Check tire condition and tread depth. • Check air pressure. • Correct if necessary. | 6-10, 6-13 |
| Brake levers | <ul style="list-style-type: none"> • Make sure that operation is smooth. • Lubricate lever pivoting points if necessary. | 6-17 |
| Centerstand | <ul style="list-style-type: none"> • Make sure that operation is smooth. • Lubricate pivot if necessary. | 6-17 |
| Chassis fasteners | <ul style="list-style-type: none"> • Make sure that all nuts, bolts and screws are properly tightened. • Tighten if necessary. | — |
| Instruments, lights, signals and switches | <ul style="list-style-type: none"> • Check operation. • Correct if necessary. | — |
| Battery | <ul style="list-style-type: none"> • Check fluid level. • Fill with distilled water if necessary. | 6-19 |

OPERATION AND IMPORTANT RIDING POINTS

EAU15951

Read the Owner's Manual carefully to become familiar with all controls. If there is a control or function you do not understand, ask your Yamaha dealer.

EWA10271

WARNING

Failure to familiarize yourself with the controls can lead to loss of control, which could cause an accident or injury.

Starting a cold engine

EAU16566

ECA10250

NOTICE

See page 5-4 for engine break-in instructions prior to operating the vehicle for the first time.

1. Turn the key to "●", and when the oil level warning light comes on, turn the key to "○".

ECA10240

NOTICE

If the oil level warning light does not come on, have a Yamaha dealer check the electrical circuit.

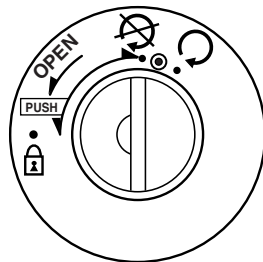

ZALM0253

2. Close the throttle completely.

3. While applying the front or rear brake, start the engine by pushing the start switch or by pushing the kickstarter lever down.

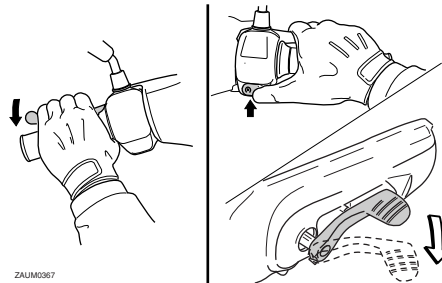

If the engine fails to start by pushing the start switch, release the switch, wait a few seconds, and then try again. Each starting attempt should be as short as possible to preserve the battery. Do not crank the engine more than 5 seconds on any one attempt. If the engine does not start with the starter motor, try using the kickstarter.

OPERATION AND IMPORTANT RIDING POINTS

NOTICE

ECA11042

For maximum engine life, never accelerate hard when the engine is cold!

Starting off

EAU16761

TIP

Before starting off, allow the engine to warm up.

1. While pulling the rear brake lever with your left hand and holding the grab bar with your right hand, push the scooter off the centerstand.

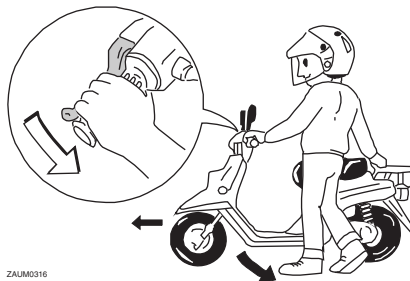

ZALUM0316

2. Sit astride the seat, and then adjust the rear view mirrors.
3. Switch the turn signals on.
4. Check for oncoming traffic, and then slowly turn the throttle grip (on the right) in order to take off.
5. Switch the turn signals off.

Acceleration and deceleration

EAU16780

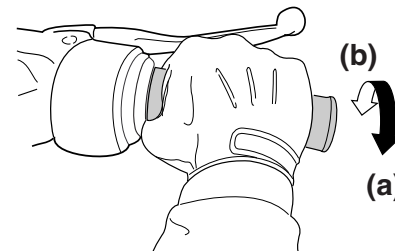

ZALUM0199

The speed can be adjusted by opening and closing the throttle. To increase the speed, turn the throttle grip in direction (a). To reduce the speed, turn the throttle grip in direction (b).

Braking

EAU16793

EWA10300

WARNING

- **Avoid braking hard or suddenly (especially when leaning over to one side), otherwise the scooter may skid or overturn.**
- **Railroad crossings, streetcar rails, iron plates on road construction sites, and manhole covers become extremely slippery when wet. Therefore, slow down when approaching such areas and cross them with caution.**
- **Keep in mind that braking on a wet road is much more difficult.**
- **Ride slowly down a hill, as braking downhill can be very difficult.**

1. Close the throttle completely.
2. Apply both front and rear brakes simultaneously while gradually increasing the pressure.

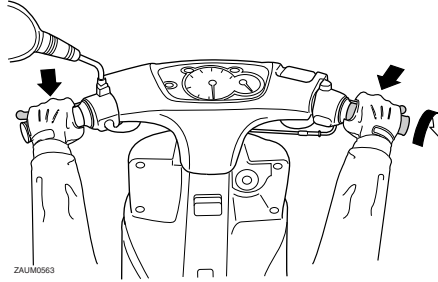

EAU16820

Tips for reducing fuel consumption

Fuel consumption depends largely on your riding style. Consider the following tips to reduce fuel consumption:

- Avoid high engine speeds during acceleration.
- Avoid high engine speeds with no load on the engine.
- Turn the engine off instead of letting it idle for an extended length of time (e.g., in traffic jams, at traffic lights or at railroad crossings).

OPERATION AND IMPORTANT RIDING POINTS

5

Engine break-in

EAU16830

There is never a more important period in the life of your engine than the period between 0 and 1000 km (600 mi). For this reason, you should read the following material carefully.

Since the engine is brand new, do not put an excessive load on it for the first 1000 km (600 mi). The various parts in the engine wear and polish themselves to the correct operating clearances. During this period, prolonged full-throttle operation or any condition that might result in engine overheating must be avoided.

EAUM2091

0–150 km (0–90 mi)

Avoid prolonged operation above 1/3 throttle. Vary the speed of the scooter from time to time. Do not operate it at one set throttle position.

150–500 km (90–300 mi)

Avoid prolonged operation above 1/2 throttle.

500–1000 km (300–600 mi)

Avoid cruising speeds in excess of 3/4 throttle.

1000 km (600 mi) and beyond

Avoid prolonged full throttle operation. Vary speeds occasionally. **NOTICE:** After 1000 km (600 mi) of operation, the final transmission oil must be changed.^[ECAM1071]

ECA10270

NOTICE

If any engine trouble should occur during the engine break-in period, immediately have a Yamaha dealer check the vehicle.

EAU17213

Parking

When parking, stop the engine, and then remove the key from the main switch.

EWA10311

WARNING

- Since the engine and exhaust system can become very hot, park in a place where pedestrians or children are not likely to touch them and be burned.
- Do not park on a slope or on soft ground, otherwise the vehicle may overturn, increasing the risk of a fuel leak and fire.
- Do not park near grass or other flammable materials which might catch fire.

PERIODIC MAINTENANCE AND ADJUSTMENT

EAU17244

Periodic inspection, adjustment, and lubrication will keep your vehicle in the safest and most efficient condition possible. Safety is an obligation of the vehicle owner/operator. The most important points of vehicle inspection, adjustment, and lubrication are explained on the following pages.

The intervals given in the periodic maintenance charts should be simply considered as a general guide under normal riding conditions. However, depending on the weather, terrain, geographical location, and individual use, the maintenance intervals may need to be shortened.

EWA10321

WARNING

Failure to properly maintain the vehicle or performing maintenance activities incorrectly may increase your risk of injury or death during service or while using the vehicle. If you are not familiar with vehicle service, have a Yamaha dealer perform service.

EWA15122

WARNING

Turn off the engine when performing maintenance unless otherwise specified.

- **A running engine has moving parts that can catch on body parts or clothing and electrical parts that can cause shocks or fires.**
- **Running the engine while servicing can lead to eye injury, burns, fire, or carbon monoxide poisoning – possibly leading to death. See page 1-3 for more information about carbon monoxide.**

EWA15460

WARNING

Brake discs, calipers, drums, and linings can become very hot during use. To avoid possible burns, let brake components cool before touching them.

EAU17302

Emission controls not only function to ensure cleaner air, but are also vital to proper engine operation and maximum performance. In the following periodic maintenance charts, the services related to emissions control are grouped separately. These services require specialized data, knowledge, and equipment. Maintenance, replacement, or repair of the emission control devices and systems may be performed by any repair establishment or individual that is certified (if applicable). Yamaha dealers are trained and equipped to perform these particular services.

PERIODIC MAINTENANCE AND ADJUSTMENT

EAU46871

TIP

- **The annual checks must be performed every year, except if a kilometer-based maintenance, or for the UK, a mileage-based maintenance, is performed instead.**
- From 30000 km (17500 mi), repeat the maintenance intervals starting from 6000 km (3500 mi).
- Items marked with an asterisk should be performed by a Yamaha dealer as they require special tools, data and technical skills.

EAU46920

Periodic maintenance chart for the emission control system

| NO. | ITEM | CHECK OR MAINTENANCE JOB | ODOMETER READING | | | | | ANNUAL CHECK |
|-----|--------------|---|---------------------|----------------------|-----------------------|------------------------|------------------------|--------------|
| | | | 1000 km (600 mi) | 6000 km (3500 mi) | 12000 km (7000 mi) | 18000 km (10500 mi) | 24000 km (14000 mi) | |
| 1 | * Fuel line | • Check fuel and vacuum hoses for cracks or damage. | | √ | √ | √ | √ | √ |
| 2 | Spark plug | • Replace. | | √ | √ | √ | √ | √ |
| 3 | * Carburetor | • Adjust engine idling speed. | √ | √ | √ | √ | √ | √ |

6

PERIODIC MAINTENANCE AND ADJUSTMENT

EAU17718

General maintenance and lubrication chart

| NO. | ITEM | CHECK OR MAINTENANCE JOB | ODOMETER READING | | | | | ANNUAL CHECK |
|-----|--------------------|--|----------------------------|----------------------|-----------------------|------------------------|------------------------|--------------|
| | | | 1000 km (600 mi) | 6000 km (3500 mi) | 12000 km (7000 mi) | 18000 km (10500 mi) | 24000 km (14000 mi) | |
| 1 | Air filter element | • Clean. | | √ | | √ | | |
| | | • Replace. | | | √ | √ | | |
| 2 | * Battery | <ul style="list-style-type: none"> • Check electrolyte level and specific gravity. • Make sure that the breather hose is properly routed. | | √ | √ | √ | √ | √ |
| 3 | * Front brake | • Check operation, fluid level and vehicle for fluid leakage. | √ | √ | √ | √ | √ | √ |
| | | • Replace brake pads. | Whenever worn to the limit | | | | | |
| 4 | * Rear brake | • Check operation and adjust brake lever free play. | √ | √ | √ | √ | √ | √ |
| | | • Replace brake shoes. | Whenever worn to the limit | | | | | |
| 5 | * Brake hose | <ul style="list-style-type: none"> • Check for cracks or damage. • Check for correct routing and clamping. | | √ | √ | √ | √ | √ |
| | | • Replace. | Every 4 years | | | | | |
| 6 | * Wheels | • Check runout and for damage. | | √ | √ | √ | √ | |
| 7 | * Tires | <ul style="list-style-type: none"> • Check tread depth and for damage. • Replace if necessary. • Check air pressure. • Correct if necessary. | | √ | √ | √ | √ | √ |
| 8 | * Wheel bearings | • Check bearing for looseness or damage. | | √ | √ | √ | √ | |

PERIODIC MAINTENANCE AND ADJUSTMENT

| NO. | ITEM | CHECK OR MAINTENANCE JOB | ODOMETER READING | | | | | ANNUAL CHECK |
|-----|---------------------------------|---|---------------------------|----------------------|-----------------------|------------------------|------------------------|--------------|
| | | | 1000 km (600 mi) | 6000 km (3500 mi) | 12000 km (7000 mi) | 18000 km (10500 mi) | 24000 km (14000 mi) | |
| 9 | * Steering bearings | • Check bearing play and steering for roughness. | √ | √ | √ | √ | √ | |
| | | • Lubricate with lithium-soap-based grease. | Every 24000 km (14000 mi) | | | | | |
| 10 | * Chassis fasteners | • Make sure that all nuts, bolts and screws are properly tightened. | | √ | √ | √ | √ | √ |
| 11 | Front brake lever pivot shaft | • Lubricate with silicone grease. | | √ | √ | √ | √ | √ |
| 12 | Rear brake lever pivot shaft | • Lubricate with lithium-soap-based grease. | | √ | √ | √ | √ | √ |
| 13 | Centerstand | • Check operation. • Lubricate. | | √ | √ | √ | √ | √ |
| 14 | * Front fork | • Check operation and for oil leakage. | | √ | √ | √ | √ | |
| 15 | * Shock absorber assembly | • Check operation and shock absorber for oil leakage. | | √ | √ | √ | √ | |
| 16 | * Autolube pump | • Check operation. • Bleed if necessary. | √ | | √ | | √ | √ |
| 17 | Final transmission oil | • Check vehicle for oil leakage. | √ | √ | | √ | | |
| | | • Change. | √ | | √ | | √ | |
| 18 | * V-belt | • Replace. | Every 10000 km (6000 mi) | | | | | |
| 19 | * Front and rear brake switches | • Check operation. | √ | √ | √ | √ | √ | √ |
| 20 | Moving parts and cables | • Lubricate. | | √ | √ | √ | √ | √ |

PERIODIC MAINTENANCE AND ADJUSTMENT

| NO. | ITEM | CHECK OR MAINTENANCE JOB | ODOMETER READING | | | | | ANNUAL CHECK |
|-----|--------------------------------|--|---------------------|----------------------|-----------------------|------------------------|------------------------|--------------|
| | | | 1000 km (600 mi) | 6000 km (3500 mi) | 12000 km (7000 mi) | 18000 km (10500 mi) | 24000 km (14000 mi) | |
| 21 | * Throttle grip | <ul style="list-style-type: none"> • Check operation. • Check throttle grip free play, and adjust if necessary. • Lubricate cable and grip housing. | | √ | √ | √ | √ | √ |
| 22 | * Lights, signals and switches | <ul style="list-style-type: none"> • Check operation. • Adjust headlight beam. | √ | √ | √ | √ | √ | √ |

EAUM2070

TIP

- The air filter needs more frequent service if you are riding in unusually wet or dusty areas.
- Hydraulic brake service
 - Regularly check and, if necessary, correct the brake fluid level.
 - Every two years change the brake fluid.
 - Replace the brake hoses every four years and if cracked or damaged.

PERIODIC MAINTENANCE AND ADJUSTMENT

Removing and installing the cowling and panels

EAU18722

The cowling and panels shown need to be removed to perform some of the maintenance jobs described in this chapter. Refer to this section each time the cowling or a panel needs to be removed and installed.

Cowling A

EAU18790

To remove the cowling

Remove the screws, and then take the cowling off.

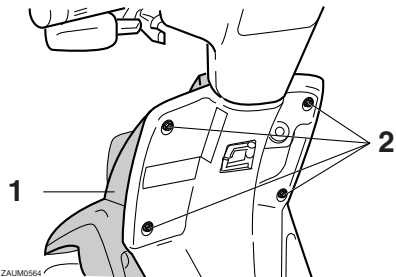

1. Cowling A
2. Screw

To install the cowling

Place the cowling in the original position, and then install the screws.

Panel A

EAU19272

To remove the panel

Remove the screw, and then pull outward on the areas shown.

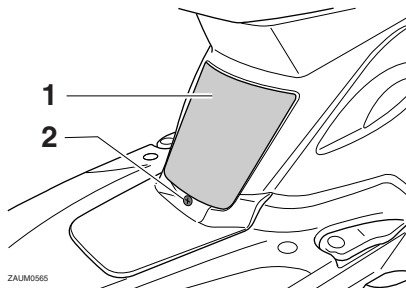

1. Panel A
2. Screw

To install the panel

Place the panel in the original position, and then install the screw.

Panel B

EAU19210

To remove the panel

Remove the screws, and then take the panel off.

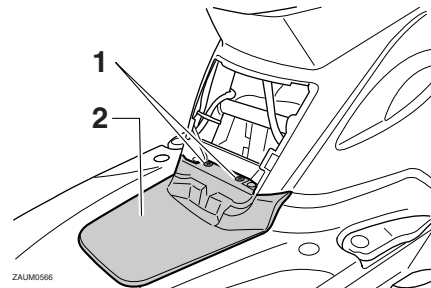

1. Screw
2. Panel B

To install the panel

Place the panel in the original position, and then install the screws.

PERIODIC MAINTENANCE AND ADJUSTMENT

Checking the spark plug

EAU19622

The spark plug is an important engine component, which should be checked periodically, preferably by a Yamaha dealer. Since heat and deposits will cause any spark plug to slowly erode, it should be removed and checked in accordance with the periodic maintenance and lubrication chart. In addition, the condition of the spark plug can reveal the condition of the engine.

The porcelain insulator around the center electrode of the spark plug should be a medium-to-light tan (the ideal color when the vehicle is ridden normally). If the spark plug shows a distinctly different color, the engine could be operating improperly. Do not attempt to diagnose such problems yourself. Instead, have a Yamaha dealer check the vehicle. If the spark plug shows signs of electrode erosion and excessive carbon or other deposits, it should be replaced.

Specified spark plug:
NGK/BR8HS

Before installing a spark plug, the spark plug gap should be measured with a wire thickness gauge and, if necessary, adjusted to specification.

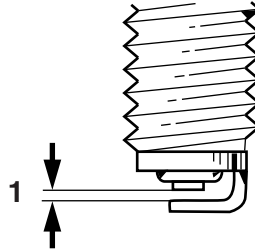

ZAUM0037

1. Spark plug gap

Spark plug gap:
0.6–0.7 mm (0.024–0.028 in)

Clean the surface of the spark plug gasket and its mating surface, and then wipe off any grime from the spark plug threads.

Tightening torque:
Spark plug:
20 Nm (2.0 m·kgf, 14 ft·lbf)

TIP

If a torque wrench is not available when installing a spark plug, a good estimate of the correct torque is 1/4–1/2 turn past finger tight. However, the spark plug should be tightened to the specified torque as soon as possible.

PERIODIC MAINTENANCE AND ADJUSTMENT

EAU20066

Final transmission oil

The final transmission case must be checked for oil leakage before each ride. If any leakage is found, have a Yamaha dealer check and repair the scooter. In addition, the final transmission oil must be changed as follows at the intervals specified in the periodic maintenance and lubrication chart.

1. Start the engine, warm up the final transmission oil by riding the scooter for several minutes, and then stop the engine.
2. Place the scooter on the center-stand.
3. Place an oil pan under the final transmission case to collect the used oil.
4. Remove the final transmission oil filler cap and its O-ring from the final transmission case.

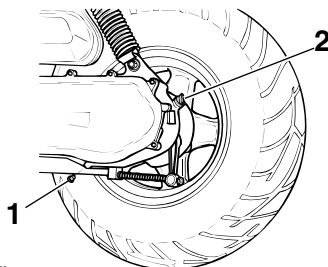

ZAJM0153

1. Final transmission oil drain bolt
2. Final transmission oil filler cap
5. Remove the final transmission oil drain bolt and its gasket to drain the oil from the final transmission case.
6. Install the final transmission oil drain bolt and its new gasket, and then tighten the bolt to the specified torque.

Tightening torque:

Final transmission oil drain bolt:
17 Nm (1.7 m·kgf, 12 ft·lbf)

7. Refill with the specified amount of the recommended final transmission oil. **WARNING! Make sure that no foreign material enters**

the final transmission case. **Make sure that no oil gets on the tire or wheel.** [EWA11311]

Recommended final transmission oil:

See page 8-1.

Oil quantity:

0.11 L (0.12 US qt, 0.10 Imp.qt)

8. Install the final transmission oil filler cap and its new O-ring, and then tighten the oil filler cap.
9. Check the final transmission case for oil leakage. If oil is leaking, check for the cause.

PERIODIC MAINTENANCE AND ADJUSTMENT

Cleaning the air filter element EAM1642

The air filter element should be cleaned at the intervals specified in the periodic maintenance and lubrication chart. Clean the air filter element more frequently if you are riding in unusually wet or dusty areas.

1. Remove the air filter case cover by removing the screws.

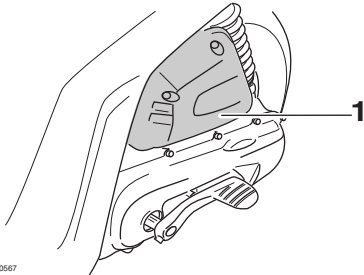

1. Air filter case cover

2. Pull the air filter element out, clean it with solvent, and then squeeze the remaining solvent out. **WARNING! Use only a dedicated parts cleaning solvent. To avoid the risk of fire or explosion, do not use gasoline or solvents with a low flash point.**

[EWA10431] **NOTICE:** To avoid damaging the foam material, handle it gently and carefully, and do not twist or wring it. [ECA10511]

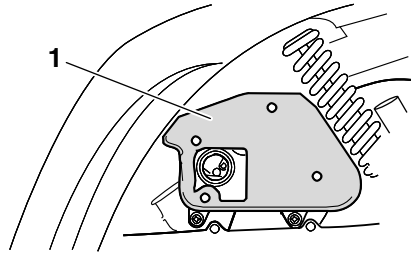

1. Air filter element

3. Apply oil of the recommended type to the entire surface of the element, and then squeeze the excess oil out.

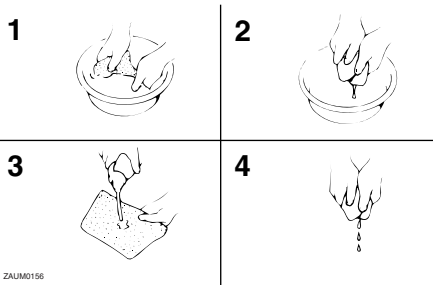

TIP

The air filter element should be wet but not dripping.

Recommended oil:
Foam air filter oil

4. Insert the element into the air filter case. **NOTICE:** Make sure that the air filter element is properly seated in the air filter case. The engine should never be operated without the air filter element installed, otherwise the piston(s) and/or cylinder(s) may become excessively worn.
5. Install the air filter case cover by installing the screws.

[ECA10481]

PERIODIC MAINTENANCE AND ADJUSTMENT

Adjusting the carburetor

EAU21300

The carburetor is an important part of the engine and requires very sophisticated adjustment. Therefore, all carburetor adjustments should be left to a Yamaha dealer, who has the necessary professional knowledge and experience.

Checking the throttle grip free play

EAU21384

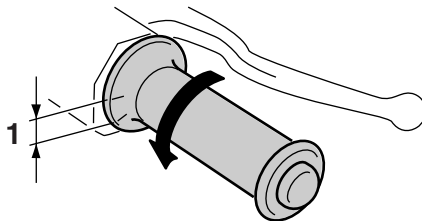

ZALIM0051

1. Throttle grip free play

The throttle grip free play should measure 1.5–3.0 mm (0.06–0.12 in) at the inner edge of the throttle grip. Periodically check the throttle grip free play and, if necessary, have a Yamaha dealer adjust it.

Tires

EAU21876

Tires are the only contact between the vehicle and the road. Safety in all conditions of riding depends on a relatively small area of road contact. Therefore, it is essential to maintain the tires in good condition at all times and replace them at the appropriate time with the specified tires.

Tire air pressure

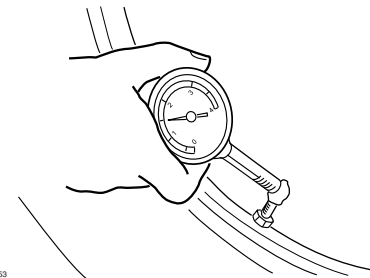

ZALIM0053

The tire air pressure should be checked and, if necessary, adjusted before each ride.

PERIODIC MAINTENANCE AND ADJUSTMENT

EWA10503

WARNING

Operation of this vehicle with improper tire pressure may cause severe injury or death from loss of control.

- The tire air pressure must be checked and adjusted on cold tires (i.e., when the temperature of the tires equals the ambient temperature).
- The tire air pressure must be adjusted in accordance with the riding speed and with the total weight of rider, passenger, cargo, and accessories approved for this model.

Tire air pressure (measured on cold tires):

0–90 kg (0–198 lb):

Front:
150 kPa (1.50 kgf/cm², 22 psi)

Rear:
150 kPa (1.50 kgf/cm², 22 psi)

90–185 kg (198–408 lb):

Front:
150 kPa (1.50 kgf/cm², 22 psi)

Rear:
150 kPa (1.50 kgf/cm², 22 psi)

Maximum load*:

185 kg (408 lb)

* Total weight of rider, passenger, cargo and accessories

EWA10511

WARNING

Never overload your vehicle. Operation of an overloaded vehicle could cause an accident.

Tire inspection

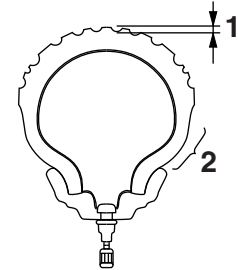

ZALUM0054

1. Tire tread depth
2. Tire sidewall

The tires must be checked before each ride. If the center tread depth reaches the specified limit, if the tire has a nail or glass fragments in it, or if the sidewall is cracked, have a Yamaha dealer replace the tire immediately.

Minimum tire tread depth (front and rear):

1.6 mm (0.06 in)

TIP

The tire tread depth limits may differ from country to country. Always comply with the local regulations.

PERIODIC MAINTENANCE AND ADJUSTMENT

Tire information

This model is equipped with tubeless tires.

Tires age, even if they have not been used or have only been used occasionally. Cracking of the tread and sidewall rubber, sometimes accompanied by carcass deformation, is an evidence of ageing. Old and aged tires shall be checked by tire specialists to ascertain their suitability for further use.

After extensive tests, only the tires listed below have been approved for this model by Yamaha Motor Co., Ltd.

Front tire:

Size:

CW50 120/90-10 57L
CW50L 120/70-12 51L
CW50N 120/90-10 57L

Manufacturer/model:

CW50 PIRELLI / SL90
CW50L PIRELLI / EVO21
CW50N PIRELLI / SL90

Rear tire:

Size:

CW50 150/80-10 65L
CW50L 130/70-12 56L
CW50N 150/80-10 65L

Manufacturer/model:

CW50 PIRELLI / SL90
CW50L PIRELLI / EVO22
CW50N PIRELLI / SL90

Yamaha dealer, who has the necessary professional knowledge and experience to do so.

- Ride at moderate speeds after changing a tire since the tire surface must first be “broken in” for it to develop its optimal characteristics.

WARNING

- Have a Yamaha dealer replace excessively worn tires. Besides being illegal, operating the vehicle with excessively worn tires decreases riding stability and can lead to loss of control.
- The replacement of all wheel and brake-related parts, including the tires, should be left to a

PERIODIC MAINTENANCE AND ADJUSTMENT

Cast wheels

To maximize the performance, durability, and safe operation of your vehicle, note the following points regarding the specified wheels.

- The wheel rims should be checked for cracks, bends, warpage or other damage before each ride. If any damage is found, have a Yamaha dealer replace the wheel. Do not attempt even the smallest repair to the wheel. A deformed or cracked wheel must be replaced.
- The wheel should be balanced whenever either the tire or wheel has been changed or replaced. An unbalanced wheel can result in poor performance, adverse handling characteristics, and a shortened tire life.

EAU21962

Checking the front brake lever free play

EAUT1221

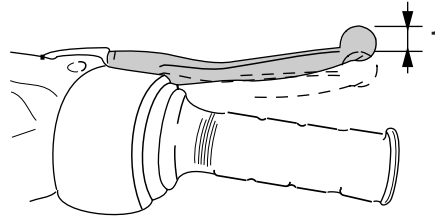

ZAUM0107

1. Front brake lever free play

The brake lever free play should measure 10.0–20.0 mm (0.39–0.79 in) as shown. Periodically check the brake lever free play and, if necessary, have a Yamaha dealer check the brake system.

⚠ WARNING

An incorrect brake lever free play indicates a hazardous condition in the brake system. Do not operate the vehicle until the brake system has been checked or repaired by a Yamaha dealer.

EWA10641

Adjusting the rear brake lever free play

EAU22170

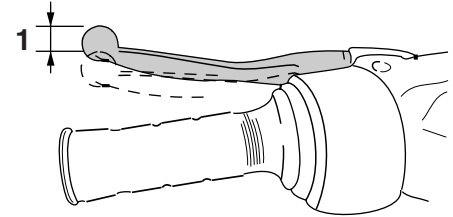

ZAUM0108

1. Rear brake lever free play

The brake lever free play should measure 10.0–20.0 mm (0.39–0.79 in) as shown. Periodically check the brake lever free play and, if necessary, adjust it as follows.

To increase the brake lever free play, turn the adjusting nut at the brake shoe plate in direction (a). To decrease the brake lever free play, turn the adjusting nut in direction (b).

PERIODIC MAINTENANCE AND ADJUSTMENT

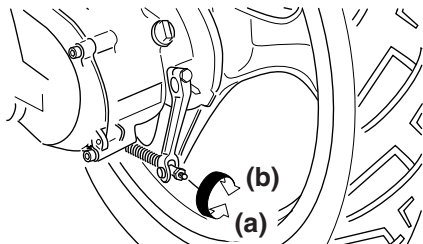

ZALUM0320

⚠ WARNING

If proper adjustment cannot be obtained as described, have a Yamaha dealer make this adjustment.

6

EWA10650

Checking the front brake pads and rear brake shoes

EAU22380

The front brake pads and the rear brake shoes must be checked for wear at the intervals specified in the periodic maintenance and lubrication chart.

Front brake pads

EAU22400

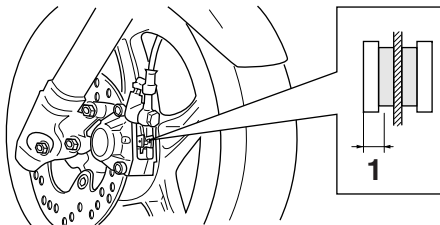

ZALUM0243

1. Lining thickness

Check each front brake pad for damage and measure the lining thickness. If a brake pad is damaged or if the lining thickness is less than 3.1 mm (0.12 in), have a Yamaha dealer replace the brake pads as a set.

Rear brake shoes

EAU22540

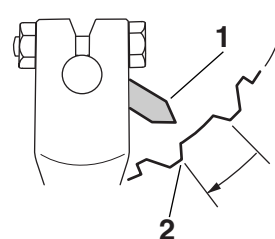

ZALUM0059

1. Wear indicator
2. Wear limit line

The rear brake is provided with a wear indicator, which allows you to check the brake shoe wear without having to disassemble the brake. To check the brake shoe wear, check the position of the wear indicator while applying the brake. If a brake shoe has worn to the point that the wear indicator reaches the wear limit line, have a Yamaha dealer replace the brake shoes as a set.

PERIODIC MAINTENANCE AND ADJUSTMENT

Checking the brake fluid level EAU32345

Before riding, check that the brake fluid is above the minimum level mark. Check the brake fluid level with the top of the reservoir level. Replenish the brake fluid if necessary.

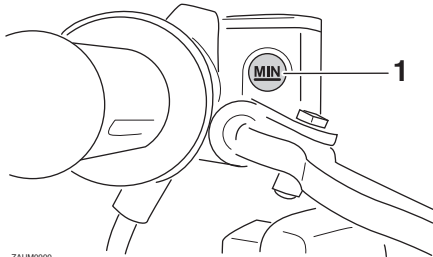

ZALUM0900

1. Minimum level mark

Specified brake fluid:
DOT 4

EWA15990

WARNING

Improper maintenance can result in loss of braking ability. Observe these precautions:

- **Insufficient brake fluid may allow air to enter the brake system, reducing braking performance.**
- **Clean the filler cap before removing. Use only DOT 4 brake fluid from a sealed container.**
- **Use only the specified brake fluid; otherwise, the rubber seals may deteriorate, causing leakage.**
- **Refill with the same type of brake fluid. Adding a brake fluid other than DOT 4 may result in a harmful chemical reaction.**
- **Be careful that water does not enter the brake fluid reservoir when refilling. Water will significantly lower the boiling point of the fluid and may result in vapor lock.**

As the brake pads wear, it is normal for the brake fluid level to gradually go down. A low brake fluid level may indicate worn brake pads and/or brake system leakage; therefore, be sure to check the brake pads for wear and the brake system for leakage. If the brake fluid level goes down suddenly, have a Yamaha dealer check the cause before further riding.

NOTICE

Brake fluid may damage painted surfaces or plastic parts. Always clean up spilled fluid immediately.

ECA17640

PERIODIC MAINTENANCE AND ADJUSTMENT

6

Changing the brake fluid

EAUM1360

Have a Yamaha dealer change the brake fluid at the intervals specified in the periodic maintenance and lubrication chart. In addition, have the brake hose replaced every four years or whenever it is damaged or leaking.

Checking and lubricating the cables

EAU50800

The operation of all control cables and the condition of the cables should be checked before each ride, and the cables and cable ends should be lubricated if necessary. If a cable is damaged or does not move smoothly, have a Yamaha dealer check or replace it. **WARNING! Damage to the outer housing of cables may result in internal rusting and cause interference with cable movement. Replace damaged cables as soon as possible to prevent unsafe conditions.**

[EWA10711]

Recommended lubricant:

Yamaha Chain and Cable Lube or 4-stroke engine oil

Checking and lubricating the throttle grip and cable

EAU23114

The operation of the throttle grip should be checked before each ride. In addition, the cable should be lubricated by a Yamaha dealer at the intervals specified in the periodic maintenance chart. The throttle cable is equipped with a rubber cover. Make sure that the cover is securely installed. Even though the cover is installed correctly, it does not completely protect the cable from water entry. Therefore, use care not to pour water directly onto the cover or cable when washing the vehicle. If the cable or cover becomes dirty, wipe clean with a moist cloth.

PERIODIC MAINTENANCE AND ADJUSTMENT

Lubricating the front and rear brake levers

EAU43642

The pivoting points of the front and rear brake levers must be lubricated at the intervals specified in the periodic maintenance and lubrication chart.

Front brake lever

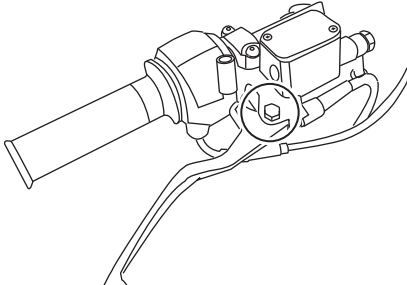

Rear brake lever

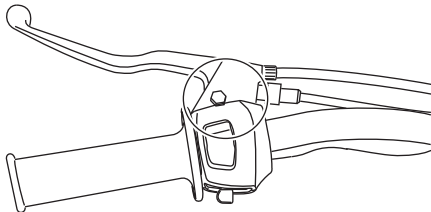

Recommended lubricants:

Front brake lever:

Silicone grease

Rear brake lever:

Lithium-soap-based grease

Checking and lubricating the centerstand

EAU23192

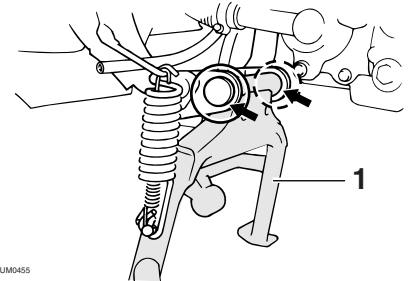

ZAUJ0455

1. Centerstand

The operation of the centerstand should be checked before each ride, and the pivots and metal-to-metal contact surfaces should be lubricated if necessary.

6

! WARNING

EWA11301

If the centerstand does not move up and down smoothly, have a Yamaha dealer check or repair it. Otherwise, the centerstand could contact the ground and distract the operator, resulting in a possible loss of control.

PERIODIC MAINTENANCE AND ADJUSTMENT

Recommended lubricant:
Lithium-soap-based grease

EAU23272

Checking the front fork

The condition and operation of the front fork must be checked as follows at the intervals specified in the periodic maintenance and lubrication chart.

To check the condition

Check the inner tubes for scratches, damage and excessive oil leakage.

To check the operation

1. Place the vehicle on a level surface and hold it in an upright position. **WARNING! To avoid injury, securely support the vehicle so there is no danger of it falling over.** [EWA10751]
2. While applying the front brake, push down hard on the handlebars several times to check if the front fork compresses and rebounds smoothly.

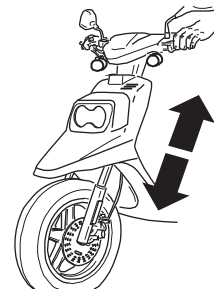

ZAJM0569

ECA10590

NOTICE

If any damage is found or the front fork does not operate smoothly, have a Yamaha dealer check or repair it.

PERIODIC MAINTENANCE AND ADJUSTMENT

Checking the steering

EAU45511

Worn or loose steering bearings may cause danger. Therefore, the operation of the steering must be checked as follows at the intervals specified in the periodic maintenance and lubrication chart.

1. Place the vehicle on the centerstand. **WARNING! To avoid injury, securely support the vehicle so there is no danger of it falling over.** [EWA10751]
2. Hold the lower ends of the front fork legs and try to move them forward and backward. If any free play can be felt, have a Yamaha dealer check or repair the steering.

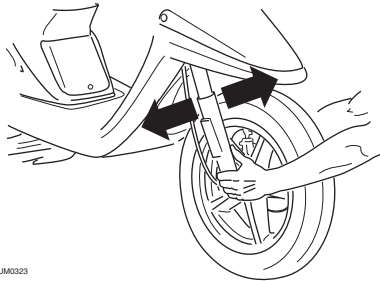

ZAJM0323

Checking the wheel bearings

EAU23291

The front and rear wheel bearings must be checked at the intervals specified in the periodic maintenance and lubrication chart. If there is play in the wheel hub or if the wheel does not turn smoothly, have a Yamaha dealer check the wheel bearings.

Battery

EAUM1404

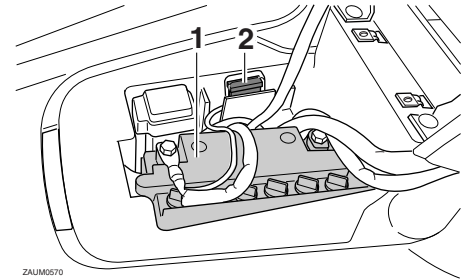

ZAJM0570

1. Battery
2. Fuse

A poorly maintained battery will corrode and discharge quickly. The electrolyte level, battery lead connections and breather hose routing should be checked before each ride and at the intervals specified in the periodic maintenance and lubrication chart.

To check the electrolyte level

1. Place the scooter on a level surface and hold it in an upright position.

PERIODIC MAINTENANCE AND ADJUSTMENT

TIP _____
Make sure that the scooter is positioned straight up when checking the electrolyte level.

2. Remove panel B. (See page 6-6.)
3. Check the electrolyte level in the battery.

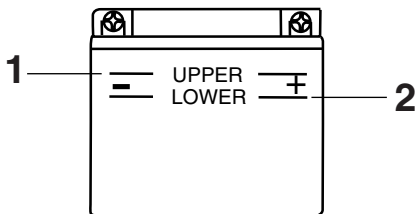

ZALUM109

1. Maximum level mark
2. Minimum level mark

TIP _____
The electrolyte should be between the minimum and maximum level marks.

4. If the electrolyte is at or below the minimum level mark, add distilled water to raise it to the maximum level mark. **NOTICE: Use only**

distilled water, as tap water contains minerals that are harmful to the battery. [ECA10611]

EWA10760

WARNING

- **Electrolyte is poisonous and dangerous since it contains sulfuric acid, which causes severe burns. Avoid any contact with skin, eyes or clothing and always shield your eyes when working near batteries. In case of contact, administer the following FIRST AID.**
 - **EXTERNAL:** Flush with plenty of water.
 - **INTERNAL:** Drink large quantities of water or milk and immediately call a physician.
 - **EYES:** Flush with water for 15 minutes and seek prompt medical attention.
- **Batteries produce explosive hydrogen gas. Therefore, keep sparks, flames, cigarettes, etc., away from the battery and provide sufficient ventilation when charging it in an enclosed space.**

- **KEEP THIS AND ALL BATTERIES OUT OF THE REACH OF CHILDREN.**

5. Check and, if necessary, tighten the battery lead connections and correct the breather hose routing.

To store the battery

1. If the scooter will not be used for more than one month, remove the battery, fully charge it, and then place it in a cool, dry place. **NOTICE: When removing the battery, be sure the key is turned to “⊗”, then disconnect the negative lead before disconnecting the positive lead.** [ECA16302]
2. If the battery will be stored for more than two months, check the specific gravity of the electrolyte at least once a month and fully charge the battery whenever necessary.
3. Fully charge the battery before installation. **NOTICE: When installing the battery, be sure the key is turned to “⊗”, then connect the positive lead before connecting the negative lead.** [ECA16840]

PERIODIC MAINTENANCE AND ADJUSTMENT

4. After installation, make sure that the battery leads are properly connected to the battery terminals and that the breather hose is properly routed, in good condition, and not obstructed. **NOTICE:** If the breather hose is positioned in such a way that the frame is exposed to electrolyte or gas expelled from the battery, the frame could suffer structural and external damages. [ECA10601]

Replacing the fuse

EAU23503

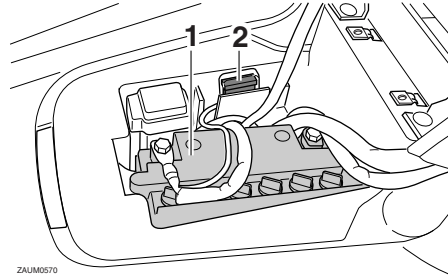

ZAU00570

1. Battery
2. Fuse

The fuse holder is located behind panel B. (See page 6-6.)

If the fuse is blown, replace it as follows.

1. Turn the key to “ \otimes ” and turn off all electrical circuits.
2. Remove the blown fuse, and then install a new fuse of the specified amperage. **WARNING! Do not use a fuse of a higher amperage rating than recommended to avoid causing extensive damage to the electrical system and possibly a fire.** [EWA15131]

Specified fuse:
7.5 A

3. Turn the key to “ \odot ” and turn on the electrical circuits to check if the devices operate.
4. If the fuse immediately blows again, have a Yamaha dealer check the electrical system.

PERIODIC MAINTENANCE AND ADJUSTMENT

Replacing a headlight bulb

EAM2930

If a headlight bulb burns out, replace it as follows.

1. Place the scooter on the center-stand.
2. Remove cowling A. (See page 6-6.)
3. Unhook the headlight bulb holder, and then remove the burnt out bulb.

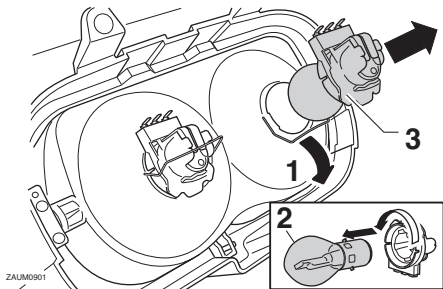

1. Unhook.
2. Headlight bulb
3. Headlight bulb holder

4. Place a new bulb into position, and then secure it with the bulb holder.
5. Install the cowling.
6. Have a Yamaha dealer adjust the headlight beam if necessary.

Replacing the tail/brake light bulb

EAU24133

1. Remove the tail/brake light lens by removing the screws.

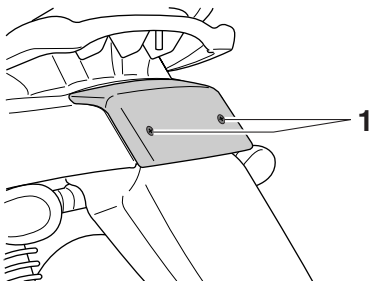

1. Screw

2. Remove the burnt-out bulb by pushing it in and turning it counter-clockwise.

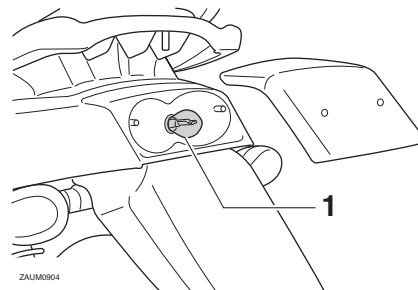

1. Tail/brake light bulb

3. Insert a new bulb into the socket, push it in, and then turn it clockwise until it stops.
4. Install the lens by installing the screws. **NOTICE: Do not over-tighten the screws, otherwise the lens may break.** [ECA10681]

PERIODIC MAINTENANCE AND ADJUSTMENT

Replacing a turn signal light bulb

EAU24204

1. Remove the turn signal light lens by removing the screw.

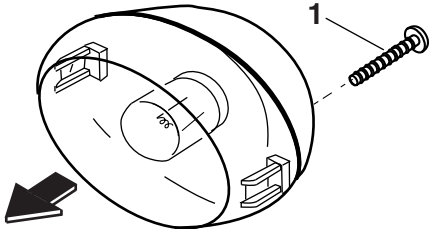

ZALUM0689

1. Screw
2. Remove the burnt-out bulb by pushing it in and turning it counter-clockwise.
3. Insert a new bulb into the socket, push it in, and then turn it clockwise until it stops.
4. Install the lens by installing the screw. **NOTICE: Do not over-tighten the screw, otherwise the lens may break.** [ECA11191]

Troubleshooting

EAU25861

Although Yamaha scooters receive a thorough inspection before shipment from the factory, trouble may occur during operation. Any problem in the fuel, compression, or ignition systems, for example, can cause poor starting and loss of power.

The following troubleshooting chart represents a quick and easy procedure for checking these vital systems yourself. However, should your scooter require any repair, take it to a Yamaha dealer, whose skilled technicians have the necessary tools, experience, and know-how to service the scooter properly.

Use only genuine Yamaha replacement parts. Imitation parts may look like Yamaha parts, but they are often inferior, have a shorter service life and can lead to expensive repair bills.

EWA15141

WARNING

When checking the fuel system, do not smoke, and make sure there are no open flames or sparks in the area, including pilot lights from water

heaters or furnaces. Gasoline or gasoline vapors can ignite or explode, causing severe injury or property damage.

PERIODIC MAINTENANCE AND ADJUSTMENT

EAU25963

Troubleshooting chart

1. Fuel

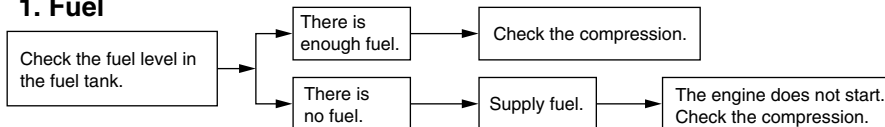

2. Compression

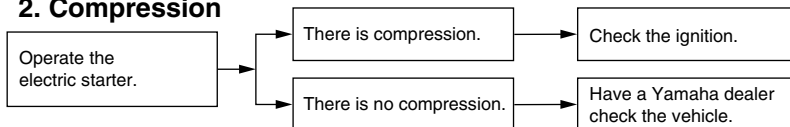

3. Ignition

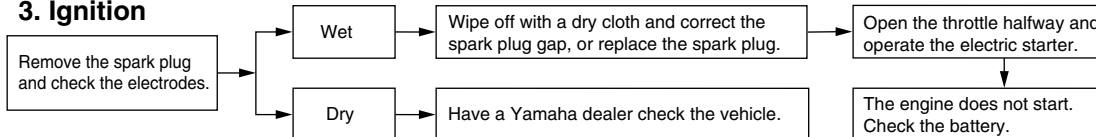

4. Battery

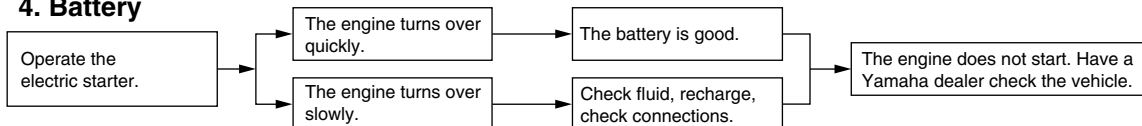

Matte color caution

EAU37833

ECA15192

NOTICE

Some models are equipped with matte colored finished parts. Be sure to consult a Yamaha dealer for advice on what products to use before cleaning the vehicle. Using a brush, harsh chemical products or cleaning compounds when cleaning these parts will scratch or damage their surface. Wax also should not be applied to any matte colored finished parts.

Care

EAU26094

While the open design of a scooter reveals the attractiveness of the technology, it also makes it more vulnerable. Rust and corrosion can develop even if high-quality components are used. A rusty exhaust pipe may go unnoticed on a car, however, it detracts from the overall appearance of a scooter. Frequent and proper care does not only comply with the terms of the warranty, but it will also keep your scooter looking good, extend its life and optimize its performance.

Before cleaning

1. Cover the muffler outlet with a plastic bag after the engine has cooled down.
2. Make sure that all caps and covers as well as all electrical couplers and connectors, including the spark plug cap, are tightly installed.
3. Remove extremely stubborn dirt, like oil burnt onto the crankcase, with a degreasing agent and a brush, but never apply such prod-

ucts onto seals, gaskets and wheel axles. Always rinse the dirt and degreaser off with water.

Cleaning

ECA10783

NOTICE

- **Avoid using strong acidic wheel cleaners, especially on spoked wheels. If such products are used on hard-to-remove dirt, do not leave the cleaner on the affected area any longer than instructed. Also, thoroughly rinse the area off with water, immediately dry it, and then apply a corrosion protection spray.**
- **Improper cleaning can damage plastic parts (such as cowlings, panels, windshields, headlight lenses, meter lenses, etc.) and the mufflers. Use only a soft, clean cloth or sponge with water to clean plastic. However, if the plastic parts cannot be thoroughly cleaned with water, diluted mild detergent with water may be used. Be sure to rinse**

SCOOTER CARE AND STORAGE

off any detergent residue using plenty of water, as it is harmful to plastic parts.

- Do not use any harsh chemical products on plastic parts. Be sure to avoid using cloths or sponges which have been in contact with strong or abrasive cleaning products, solvent or thinner, fuel (gasoline), rust removers or inhibitors, brake fluid, antifreeze or electrolyte.
- Do not use high-pressure washers or steam-jet cleaners since they cause water seepage and deterioration in the following areas: seals (of wheel and swing-arm bearings, fork and brakes), electric components (couplers, connectors, instruments, switches and lights), breather hoses and vents.
- For scooters equipped with a windshield: Do not use strong cleaners or hard sponges as they will cause dulling or scratching. Some cleaning compounds for plastic may leave scratches on the windshield.

Test the product on a small hidden part of the windshield to make sure that it does not leave any marks. If the windshield is scratched, use a quality plastic polishing compound after washing.

After normal use

Remove dirt with warm water, a mild detergent, and a soft, clean sponge, and then rinse thoroughly with clean water. Use a toothbrush or bottlebrush for hard-to-reach areas. Stubborn dirt and insects will come off more easily if the area is covered with a wet cloth for a few minutes before cleaning.

After riding in the rain, near the sea or on salt-sprayed roads

Since sea salt or salt sprayed on the roads during winter are extremely corrosive in combination with water, carry out the following steps after each ride in the rain, near the sea or on salt-sprayed roads.

TIP

Salt sprayed on roads in the winter may remain well into spring.

1. Clean the scooter with cold water and a mild detergent after the engine has cooled down. **NOTICE: Do not use warm water since it increases the corrosive action of the salt.**^[ECA10791]
2. Apply a corrosion protection spray on all metal, including chrome- and nickel-plated, surfaces to prevent corrosion.

After cleaning

1. Dry the scooter with a chamois or an absorbing cloth.
2. Use a chrome polish to shine chrome, aluminum and stainless-steel parts, including the exhaust system. (Even the thermally induced discoloring of stainless-steel exhaust systems can be removed through polishing.)

3. To prevent corrosion, it is recommended to apply a corrosion protection spray on all metal, including chrome- and nickel-plated, surfaces.
4. Use spray oil as a universal cleaner to remove any remaining dirt.
5. Touch up minor paint damage caused by stones, etc.
6. Wax all painted surfaces.
7. Let the scooter dry completely before storing or covering it.

EWA10942

WARNING

Contaminants on the brakes or tires can cause loss of control.

- **Make sure that there is no oil or wax on the brakes or tires. If necessary, clean the brake discs and brake linings with a regular brake disc cleaner or acetone, and wash the tires with warm water and a mild detergent.**
- **Before operating the scooter test its braking performance and cornering behavior.**

ECA10800

NOTICE

- **Apply spray oil and wax sparingly and make sure to wipe off any excess.**
- **Never apply oil or wax to any rubber and plastic parts, but treat them with a suitable care product.**
- **Avoid using abrasive polishing compounds as they will wear away the paint.**

TIP

- Consult a Yamaha dealer for advice on what products to use.
- Washing, rainy weather or humid climates can cause the headlight lens to fog. Turning the headlight on for a short period of time will help remove the moisture from the lens.

EAU26303

Storage

Short-term

Always store your scooter in a cool, dry place and, if necessary, protect it against dust with a porous cover. Be sure the engine and the exhaust system are cool before covering the scooter.

ECA10820

NOTICE

- **Storing the scooter in a poorly ventilated room or covering it with a tarp, while it is still wet, will allow water and humidity to seep in and cause rust.**
- **To prevent corrosion, avoid damp cellars, stables (because of the presence of ammonia) and areas where strong chemicals are stored.**

Long-term

Before storing your scooter for several months:

1. Follow all the instructions in the “Care” section of this chapter.

SCOOTER CARE AND STORAGE

2. Drain the carburetor float chamber by loosening the drain bolt; this will prevent fuel deposits from building up. Pour the drained fuel into the fuel tank.
3. Fill up the fuel tank and add fuel stabilizer (if available) to prevent the fuel tank from rusting and the fuel from deteriorating.
4. Perform the following steps to protect the cylinder, piston rings, etc. from corrosion.
 - a. Remove the spark plug cap and spark plug.
 - b. Pour a teaspoonful of engine oil into the spark plug bore.
 - c. Install the spark plug cap onto the spark plug, and then place the spark plug on the cylinder head so that the electrodes are grounded. (This will limit sparking during the next step.)
 - d. Turn the engine over several times with the starter. (This will coat the cylinder wall with oil.)**WARNING! To prevent damage or injury from sparking, make sure to ground the**

spark plug electrodes while turning the engine over.

[EWA10951]

- e. Remove the spark plug cap from the spark plug, and then install the spark plug and the spark plug cap.
5. Lubricate all control cables and the pivoting points of all levers and pedals as well as of the side-stand/centerstand.
6. Check and, if necessary, correct the tire air pressure, and then lift the scooter so that both of its wheels are off the ground. Alternatively, turn the wheels a little every month in order to prevent the tires from becoming degraded in one spot.
7. Cover the muffler outlet with a plastic bag to prevent moisture from entering it.
8. Remove the battery and fully charge it. Store it in a cool, dry place and charge it once a month. Do not store the battery in an excessively cold or warm place [less than 0 °C (30 °F) or more than 30

°C (90 °F)]. For more information on storing the battery, see page 6-19.

TIP

Make any necessary repairs before storing the scooter.

Dimensions:

- Overall length:
1685 mm (66.3 in)
- Overall width:
CW50 675 mm (26.6 in)
CW50L 675 mm (26.6 in)
CW50N 718 mm (28.3 in)
- Overall height:
CW50 1058 mm (41.7 in)
CW50L 1058 mm (41.7 in)
CW50N 1070 mm (42.1 in)
- Seat height:
768 mm (30.2 in)
- Wheelbase:
1172 mm (46.1 in)
- Ground clearance:
124 mm (4.88 in)
- Minimum turning radius:
1773 mm (69.8 in)

Weight:

- Curb weight:
82 kg (181 lb)

Engine:

- Engine type:
Air cooled 2-stroke
- Cylinder arrangement:
Single cylinder
- Displacement:
49 cm³
- Bore × stroke:
40.0 × 39.2 mm (1.57 × 1.54 in)
- Compression ratio:
7.22 : 1

Starting system:

- Electric starter and kickstarter

Lubrication system:

- Separate lubrication (Yamaha autolube)

Engine oil:

Type:

- YAMALUBE 2S or 2-stroke engine oil (JASO FC grade) or (ISO EG-C or EG-D grade)

Engine oil quantity:

Quantity:

- 1.10 L (1.16 US qt, 0.97 Imp.qt)

Final transmission oil:

Type:

- SAE 10W-30 type SE motor oil

Quantity:

- 0.11 L (0.12 US qt, 0.10 Imp.qt)

Air filter:

Air filter element:

- Wet element

Fuel:

Recommended fuel:

- Premium unleaded gasoline only

Fuel tank capacity:

- 5.3 L (1.40 US gal, 1.17 Imp.gal)

Fuel reserve amount:

- CW50 1.2 L (0.32 US gal, 0.26 Imp.gal)
- CW50L 1.2 L (0.32 US gal, 0.26 Imp.gal)
- CW50N 1.5 L (0.40 US gal, 0.33 Imp.gal)

Carburetor:

Type × quantity:

- PYA-12 x 1

Spark plug(s):

Manufacturer/model:

- NGK/BR8HS

Spark plug gap:

- 0.6–0.7 mm (0.024–0.028 in)

Clutch:

Clutch type:

- Dry, centrifugal automatic

Transmission:

Primary reduction ratio:

- 1

Final drive:

- Gear

Secondary reduction ratio:

- 12.923 (52/13x42/13)

Transmission type:

- V-belt automatic

Chassis:

Frame type:

- Underbone

Caster angle:

- 27.00 °

Trail:

- 90 mm (3.5 in)

Front tire:

Type:

- Tubeless

Size:

- CW50 120/90-10 57L
- CW50L 120/70-12 51L
- CW50N 120/90-10 57L

SPECIFICATIONS

Manufacturer/model:

CW50 PIRELLI / SL90
CW50L PIRELLI / EVO21
CW50N PIRELLI / SL90

Rear tire:

Type:
Tubeless

Size:

CW50 150/80-10 65L
CW50L 130/70-12 56L
CW50N 150/80-10 65L

Manufacturer/model:

CW50 PIRELLI / SL90
CW50L PIRELLI / EVO22
CW50N PIRELLI / SL90

Loading:

Maximum load:
185 kg (408 lb)
(Total weight of rider, passenger, cargo and accessories)

Tire air pressure (measured on cold tires):

Loading condition:
0–90 kg (0–198 lb)
Front:
150 kPa (1.50 kgf/cm², 22 psi)
Rear:
150 kPa (1.50 kgf/cm², 22 psi)

Loading condition:
90–185 kg (198–408 lb)
Front:
150 kPa (1.50 kgf/cm², 22 psi)
Rear:
150 kPa (1.50 kgf/cm², 22 psi)

Front wheel:

Wheel type:
Cast wheel
Rim size:
CW50 10xMT3.00
CW50L 12xMT3.50
CW50N 10xMT3.00

Rear wheel:

Wheel type:
Cast wheel
Rim size:
CW50 10xMT4.00
CW50L 12xMT3.50
CW50N 10xMT4.00

Front brake:

Type:
Single disc brake
Operation:
Right hand operation
Specified brake fluid:
DOT 4

Rear brake:

Type:
Drum brake
Operation:
Left hand operation

Front suspension:

Type:
Telescopic fork
Spring/shock absorber type:
Coil spring/oil damper
Wheel travel:
70.0 mm (2.76 in)

Rear suspension:

Type:
Unit swing
Spring/shock absorber type:
Coil spring/oil damper
Wheel travel:
CW50 70.0 mm (2.76 in)
CW50L 67.0 mm (2.64 in)
CW50N 70.0 mm (2.76 in)

Electrical system:

Ignition system:
DC CDI
Charging system:
AC magneto

Battery:

Model:
CB4-LB(GS), YB4L-B(YUASA)
Voltage, capacity:
12 V, 4.0 Ah

Headlight:

Bulb type:
Incandescence

Bulb voltage, wattage × quantity:

Headlight:
12 V, 25.0 W/25.0 W × 2
Tail/brake light:
12 V, 5.0 W/21.0 W × 1
Front turn signal light:
12 V, 10.0 W × 2
Rear turn signal light:
12 V, 10.0 W × 2
Meter lighting:
CW50 12 V, 1.2 W × 3
CW50L 12 V, 1.2 W × 3

Meter lighting:

CW50N EL (Electroluminescent)

High beam indicator light:

CW50 12 V, 2.0 W × 1

CW50L 12 V, 2.0 W × 1

High beam indicator light:

CW50N LED

Oil level warning light:

CW50 12 V, 2.0 W × 1

CW50L 12 V, 2.0 W × 1

Oil level warning light:

CW50N LED

Turn signal indicator light:

CW50 12 V, 2.0 W × 2

CW50L 12 V, 2.0 W × 2

Turn signal indicator light:

CW50N LED x1

Fuel level warning light:

CW50N LED

Fuses:

Main fuse:

7.5 A

CONSUMER INFORMATION

EAU48612

Identification numbers

Record the vehicle identification number and model label information in the spaces provided below for assistance when ordering spare parts from a Yamaha dealer or for reference in case the vehicle is stolen.

VEHICLE IDENTIFICATION
NUMBER:

MODEL LABEL INFORMATION:

Vehicle identification number

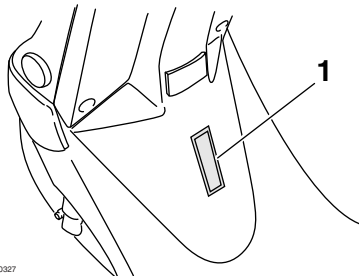

ZAUM0327

1. Vehicle identification number

The vehicle identification number is stamped into the frame.

TIP _____
The vehicle identification number is used to identify your vehicle and may be used to register it with the licensing authority in your area.

EAU26410

Model label

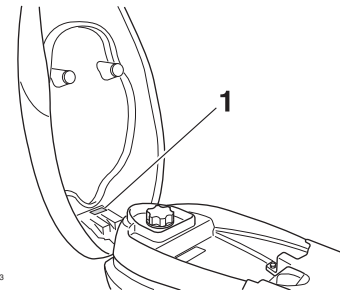

ZAUM0903

1. Model label

The model label is affixed to the bottom of the seat. (See page 3-9.) Record the information on this label in the space provided. This information will be needed when ordering spare parts from a Yamaha dealer.

EAU26490

- A**
- Acceleration and deceleration 5-2
 - Air filter element, cleaning 6-9
 - Anti-theft device housing 3-10
- B**
- Battery 6-19
 - Brake fluid, changing 6-16
 - Brake fluid level, checking 6-15
 - Brake lever, front 3-5
 - Brake lever, rear 3-6
 - Brake levers, lubricating 6-17
 - Brake pads and shoes, checking 6-14
 - Braking 5-3
- C**
- Cables, checking and lubricating 6-16
 - Carburetor, adjusting 6-10
 - Care 7-1
 - Catalytic converter 3-8
 - Centerstand, checking and lubricating 6-17
 - Cowling and panels, removing and installing 6-6
- D**
- Dimmer switch 3-5
- E**
- Engine break-in 5-4
 - Engine oil 3-8
- F**
- Final transmission oil 6-8
 - Front brake lever free play, checking ... 6-13
 - Front fork, checking 6-18
 - Fuel 3-7
 - Fuel and 2-stroke engine oil tank caps ... 3-6
 - Fuel consumption, tips for reducing 5-3
 - Fuel gauge (CW50/CW50L) 3-4
 - Fuel level warning light (CW50N) 3-3
 - Fuse, replacing 6-21
- H**
- Handlebar switches 3-5
 - Headlight bulb, replacing 6-22
 - High beam indicator light 3-2
 - Horn switch 3-5
- I**
- Identification numbers 9-1
 - Indicator lights and warning lights 3-2
- K**
- Kickstarter 3-9
- L**
- Luggage hook 3-11
- M**
- Main switch/steering lock 3-1
 - Maintenance and lubrication, periodic 6-3
 - Maintenance, emission control system ... 6-2
 - Matte color, caution 7-1
 - Model label 9-1
- O**
- Oil level warning light 3-2
- P**
- Parking 5-4
 - Part locations 2-1
- R**
- Rear brake lever free play, adjusting ... 6-13
- S**
- Safe-riding points 1-5
 - Safety information 1-1
 - Seat 3-9
 - Securing bracket 3-9
 - Shock absorber assembly, adjusting (CW50L model only) 3-10
 - Spark plug, checking 6-7
 - Specifications 8-1
 - Speedometer unit (CW50/CW50L) 3-3
 - Speedometer unit (CW50N) 3-4
 - Starting a cold engine 5-1
 - Starting off 5-2
 - Start switch 3-5
 - Steering, checking 6-19
 - Storage 7-3
- T**
- Tail/brake light bulb, replacing 6-22
 - Throttle grip and cable, checking and lubricating 6-16
 - Throttle grip free play, checking 6-10
 - Tires 6-10
 - Troubleshooting 6-23
 - Troubleshooting chart 6-24
 - Turn signal indicator light (CW50N) 3-2
 - Turn signal indicator lights (CW50/CW50L) 3-2
 - Turn signal light bulb, replacing 6-23
 - Turn signal switch 3-5
- V**
- Vehicle identification number 9-1
- W**
- Wheel bearings, checking 6-19
 - Wheels 6-13



MBK Industrie

Z.I. de Rouvroy 02100 Saint Quentin

Société Anonyme au capital de 45 000 000 €

R.C St-Quentin B 329 035 422

PRINTED IN FRANCE
2012.11 (E)