



⚠ Read this manual carefully before operating this vehicle.

OWNER'S MANUAL

SUPER

TENERE

XT1200ZE

2KB-28199-EG

 **Read this manual carefully before operating this vehicle. This manual should stay with this vehicle if it is sold.**



YAMAHA MOTOR ELECTRONICS CO., LTD.

1450-6, Mori, Mori-machi, Shuchi-gun, Shizuoka-ken, 437-0292 Japan

DECLARATION of CONFORMITY

For



Product: IMMOBILIZER
Model: 2BS-00

Supplied by

YAMAHA MOTOR ELECTRONICS
CO.,LTD.
1450-6 Mori, Mori-machi Shuchi-gun
Shizuoka 437-0292 Japan

Technical Construction File held by

YAMAHA MOTOR ELECTRONICS
CO.,LTD.
1450-6 Mori, Mori-machi Shuchi-gun
Shizuoka 437-0292 Japan

Standard used for comply

R&TTE Directive
(Article 3.1(a) Safety)
EN 60950-1: 2006 + Amd.11:2009 + Amd.1:2010 +
Amd.12: 2011
EN 62479: 2010

R&TTE Directive
(Article 3.1(b) EMC)
97/24/EC from 17.06.1997

R&TTE Directive
(Article 3.2 Spectrum)
EN 300 330-1 V1.7.1: 2010
EN 300 330-2 V1.5.1: 2010

Means of Conformity

We declare under our sole responsibility that the Product (s) is conformity with the essential requirements and other relevant requirements of the
Radio and Telecommunication Terminal Equipment (R&TTE) Directive (1999/5/EC).

Date of issue: January 12, 2015

Signature of Responsible Person:

高杉和彦

Kazuhide Takasugi
GENERAL MANAGER
QUALITY ASSURANCE DIV.

Welcome to the Yamaha world of motorcycling!

As the owner of the XT1200ZE, you are benefiting from Yamaha's vast experience and newest technology regarding the design and manufacture of high-quality products, which have earned Yamaha a reputation for dependability.

Please take the time to read this manual thoroughly, so as to enjoy all advantages of your XT1200ZE. The Owner's Manual does not only instruct you in how to operate, inspect and maintain your motorcycle, but also in how to safeguard yourself and others from trouble and injury.

In addition, the many tips given in this manual will help keep your motorcycle in the best possible condition. If you have any further questions, do not hesitate to contact your Yamaha dealer.

The Yamaha team wishes you many safe and pleasant rides. So, remember to put safety first!

Yamaha continually seeks advancements in product design and quality. Therefore, while this manual contains the most current product information available at the time of printing, there may be minor discrepancies between your motorcycle and this manual. If there is any question concerning this manual, please consult a Yamaha dealer.





Please read this manual carefully and completely before operating this motorcycle.

IMPORTANT MANUAL INFORMATION

EAU10134

Particularly important information is distinguished in this manual by the following notations:

	This is the safety alert symbol. It is used to alert you to potential personal injury hazards. Obey all safety messages that follow this symbol to avoid possible injury or death.
 WARNING	A WARNING indicates a hazardous situation which, if not avoided, could result in death or serious injury.
NOTICE	A NOTICE indicates special precautions that must be taken to avoid damage to the vehicle or other property.
TIP	A TIP provides key information to make procedures easier or clearer.

*Product and specifications are subject to change without notice.

IMPORTANT MANUAL INFORMATION

EAU10201

**XT1200ZE
OWNER'S MANUAL**
©2015 by Yamaha Motor Co., Ltd.
1st edition, April 2015
All rights reserved.
Any reprinting or unauthorized use
without the written permission of
Yamaha Motor Co., Ltd.
is expressly prohibited.
Printed in Japan.

TABLE OF CONTENTS

SAFETY INFORMATION	1-1	Adjusting the front and rear suspension	3-37	Coolant	6-15
DESCRIPTION	2-1	Carriers.....	3-42	Air filter element.....	6-17
Left view	2-1	Luggage strap holders	3-42	Checking the engine idling speed	6-17
Right view.....	2-2	Sidestand	3-43	Checking the throttle grip free play.....	6-17
Controls and instruments	2-3	Ignition circuit cut-off system	3-43	Valve clearance.....	6-18
INSTRUMENT AND CONTROL FUNCTIONS	3-1	Auxiliary DC jack.....	3-45	Tires	6-18
Immobilizer system.....	3-1	FOR YOUR SAFETY – PRE-OPERATION CHECKS	4-1	Spoke wheels	6-20
Main switch/steering lock.....	3-2	OPERATION AND IMPORTANT RIDING POINTS	5-1	Clutch lever.....	6-21
Indicator lights and warning lights.....	3-4	Starting the engine.....	5-1	Checking the brake lever free play.....	6-21
Cruise control system.....	3-7	Shifting	5-2	Brake light switches	6-22
Multi-function meter unit	3-10	Tips for reducing fuel consumption	5-3	Checking the front and rear brake pads	6-22
D-mode (drive mode).....	3-24	Engine break-in.....	5-3	Checking the brake fluid level	6-23
Handlebar switches.....	3-24	Parking	5-4	Changing the brake and clutch fluids.....	6-24
Clutch lever	3-26	PERIODIC MAINTENANCE AND ADJUSTMENT	6-1	Checking and lubricating the throttle grip and cable	6-24
Shift pedal	3-27	Owner's tool kit.....	6-2	Checking and lubricating the brake and shift pedals.....	6-25
Brake lever.....	3-27	Periodic maintenance chart for the emission control system	6-3	Checking and lubricating the brake and clutch levers	6-25
Brake pedal	3-28	General maintenance and lubrication chart.....	6-4	Checking and lubricating the centerstand and sidestand.....	6-26
ABS	3-28	Removing and installing cowlings... 6-8		Lubricating the swingarm pivots.....	6-27
Traction control system.....	3-29	Checking the spark plugs	6-10	Checking the front fork.....	6-27
Fuel tank cap.....	3-31	Engine oil and oil filter cartridge... 6-11		Checking the steering.....	6-28
Fuel.....	3-32	Final gear oil.....	6-14	Checking the wheel bearings	6-28
Fuel tank breather hose and overflow hose.....	3-33				
Catalytic converter	3-33				
Rider seat	3-34				
Adjusting the rider seat height.....	3-35				
Windshield.....	3-36				

TABLE OF CONTENTS

Battery	6-28
Replacing the fuses	6-30
Replacing a headlight bulb	6-31
Replacing an auxiliary light bulb	6-33
Turn signal light and tail/brake light	6-35
Replacing a license plate light bulb	6-35
Troubleshooting	6-36
Troubleshooting charts	6-37

MOTORCYCLE CARE AND

STORAGE	7-1
Matte color caution	7-1
Care	7-1
Storage	7-4

SPECIFICATIONS.....8-1

CONSUMER INFORMATION	9-1
Identification numbers	9-1

INDEX.....10-1

Be a Responsible Owner

As the vehicle's owner, you are responsible for the safe and proper operation of your motorcycle.

Motorcycles are single-track vehicles. Their safe use and operation are dependent upon the use of proper riding techniques as well as the expertise of the operator. Every operator should know the following requirements before riding this motorcycle.

He or she should:

- Obtain thorough instructions from a competent source on all aspects of motorcycle operation.
- Observe the warnings and maintenance requirements in this Owner's Manual.
- Obtain qualified training in safe and proper riding techniques.
- Obtain professional technical service as indicated in this Owner's Manual and/or when made necessary by mechanical conditions.

- Never operate a motorcycle without proper training or instruction. Take a training course. Beginners should receive training from a certified instructor. Contact an authorized motorcycle dealer to find out about the training courses nearest you.

Safe Riding

Perform the pre-operation checks each time you use the vehicle to make sure it is in safe operating condition. Failure to inspect or maintain the vehicle properly increases the possibility of an accident or equipment damage. See page 4-1 for a list of pre-operation checks.

- This motorcycle is designed to carry the operator and a passenger.
- The failure of motorists to detect and recognize motorcycles in traffic is the predominating cause of automobile/motorcycle accidents. Many accidents have been caused by an automobile driver who did not see the motorcycle. Making yourself conspicuous ap-

pears to be very effective in reducing the chance of this type of accident.

Therefore:

- Wear a brightly colored jacket.
- Use extra caution when you are approaching and passing through intersections, since intersections are the most likely places for motorcycle accidents to occur.
- Ride where other motorists can see you. Avoid riding in another motorist's blind spot.
- Never maintain a motorcycle without proper knowledge. Contact an authorized motorcycle dealer to inform you on basic motorcycle maintenance. Certain maintenance can only be carried out by certified staff.

- Many accidents involve inexperienced operators. In fact, many operators who have been involved in accidents do not even have a current motorcycle license.
 - Make sure that you are qualified and that you only lend your motorcycle to other qualified operators.
 - Know your skills and limits. Staying within your limits may help you to avoid an accident.
 - We recommend that you practice riding your motorcycle where there is no traffic until you have become thoroughly familiar with the motorcycle and all of its controls.
 - Many accidents have been caused by error of the motorcycle operator. A typical error made by the operator is veering wide on a turn due to excessive speed or undercornering (insufficient lean angle for the speed).
 - Always obey the speed limit and never travel faster than warranted by road and traffic conditions.
 - Always signal before turning or changing lanes. Make sure that other motorists can see you.
 - The posture of the operator and passenger is important for proper control.
 - The operator should keep both hands on the handlebar and both feet on the operator footrests during operation to maintain control of the motorcycle.
 - The passenger should always hold onto the operator, the seat strap or grab bar, if equipped, with both hands and keep both feet on the passenger footrests. Never carry a passenger unless he or she can firmly place both feet on the passenger footrests.
 - Never ride under the influence of alcohol or other drugs.
- Protective Apparel**
- The majority of fatalities from motorcycle accidents are the result of head injuries. The use of a safety helmet is the single most critical factor in the prevention or reduction of head injuries.
- Always wear an approved helmet.
- Avoid Carbon Monoxide Poisoning**
- All engine exhaust contains carbon monoxide, a deadly gas. Breathing carbon monoxide can cause headaches, dizziness, drowsiness, nausea, confusion, and eventually death.
- Wear a face shield or goggles. Wind in your unprotected eyes could contribute to an impairment of vision that could delay seeing a hazard.
 - The use of a jacket, heavy boots, trousers, gloves, etc., is effective in preventing or reducing abrasions or lacerations.
 - Never wear loose-fitting clothes, otherwise they could catch on the control levers, footrests, or wheels and cause injury or an accident.
 - Always wear protective clothing that covers your legs, ankles, and feet. The engine or exhaust system become very hot during or after operation and can cause burns.
 - A passenger should also observe the above precautions.

SAFETY INFORMATION

1

Carbon Monoxide is a colorless, odorless, tasteless gas which may be present even if you do not see or smell any engine exhaust. Deadly levels of carbon monoxide can collect rapidly and you can quickly be overcome and unable to save yourself. Also, deadly levels of carbon monoxide can linger for hours or days in enclosed or poorly ventilated areas. If you experience any symptoms of carbon monoxide poisoning, leave the area immediately, get fresh air, and **SEEK MEDICAL TREATMENT.**

- Do not run engine indoors. Even if you try to ventilate engine exhaust with fans or open windows and doors, carbon monoxide can rapidly reach dangerous levels.
- Do not run engine in poorly ventilated or partially enclosed areas such as barns, garages, or carports.
- Do not run engine outdoors where engine exhaust can be drawn into a building through openings such as windows and doors.

Loading

Adding accessories or cargo to your motorcycle can adversely affect stability and handling if the weight distribution of the motorcycle is changed. To avoid the possibility of an accident, use extreme caution when adding cargo or accessories to your motorcycle. Use extra care when riding a motorcycle that has added cargo or accessories. Here, along with the information about accessories below, are some general guidelines to follow if loading cargo to your motorcycle:

The total weight of the operator, passenger, accessories and cargo must not exceed the maximum load limit.

Operation of an overloaded vehicle could cause an accident.

<p>Maximum load: 205 kg (452 lb)</p>

When loading within this weight limit, keep the following in mind:

- Cargo and accessory weight should be kept as low and close to the motorcycle as possible. Securely pack your heaviest items as

close to the center of the vehicle as possible and make sure to distribute the weight as evenly as possible on both sides of the motorcycle to minimize imbalance or instability.

- Shifting weights can create a sudden imbalance. Make sure that accessories and cargo are securely attached to the motorcycle before riding. Check accessory mounts and cargo restraints frequently.
- Properly adjust the suspension for your load (suspension-adjustable models only), and check the condition and pressure of your tires.
- Never attach any large or heavy items to the handlebar, front fork, or front fender. These items, including such cargo as sleeping bags, duffel bags, or tents, can create unstable handling or a slow steering response.
- **This vehicle is not designed to pull a trailer or to be attached to a sidecar.**

Genuine Yamaha Accessories

Choosing accessories for your vehicle is an important decision. Genuine Yamaha accessories, which are available only from a Yamaha dealer, have been designed, tested, and approved by Yamaha for use on your vehicle.

Many companies with no connection to Yamaha manufacture parts and accessories or offer other modifications for Yamaha vehicles. Yamaha is not in a position to test the products that these aftermarket companies produce. Therefore, Yamaha can neither endorse nor recommend the use of accessories not sold by Yamaha or modifications not specifically recommended by Yamaha, even if sold and installed by a Yamaha dealer.

Aftermarket Parts, Accessories, and Modifications

While you may find aftermarket products similar in design and quality to genuine Yamaha accessories, recognize that some aftermarket accessories or modifications are not suitable because of potential safety hazards to you or others. Installing aftermarket

products or having other modifications performed to your vehicle that change any of the vehicle's design or operation characteristics can put you and others at greater risk of serious injury or death. You are responsible for injuries related to changes in the vehicle.

Keep the following guidelines in mind, as well as those provided under "Loading" when mounting accessories.

- Never install accessories or carry cargo that would impair the performance of your motorcycle. Carefully inspect the accessory before using it to make sure that it does not in any way reduce ground clearance or cornering clearance, limit suspension travel, steering travel or control operation, or obscure lights or reflectors.
- Accessories fitted to the handlebar or the front fork area can create instability due to improper weight distribution or aerodynamic changes. If accessories are added to the handlebar or

front fork area, they must be as lightweight as possible and should be kept to a minimum.

- Bulky or large accessories may seriously affect the stability of the motorcycle due to aerodynamic effects. Wind may attempt to lift the motorcycle, or the motorcycle may become unstable in cross winds. These accessories may also cause instability when passing or being passed by large vehicles.
- Certain accessories can displace the operator from his or her normal riding position. This improper position limits the freedom of movement of the operator and may limit control ability, therefore, such accessories are not recommended.
- Use caution when adding electrical accessories. If electrical accessories exceed the capacity of the motorcycle's electrical system, an electric failure could result, which could cause a dangerous loss of lights or engine power.

SAFETY INFORMATION

1

Aftermarket Tires and Rims

The tires and rims that came with your motorcycle were designed to match the performance capabilities and to provide the best combination of handling, braking, and comfort. Other tires, rims, sizes, and combinations may not be appropriate. Refer to page 6-18 for tire specifications and more information on replacing your tires.

Transporting the Motorcycle

Be sure to observe following instructions before transporting the motorcycle in another vehicle.

- Remove all loose items from the motorcycle.
- Check that the fuel cock (if equipped) is in the “OFF” position and that there are no fuel leaks.
- Point the front wheel straight ahead on the trailer or in the truck bed, and choke it in a rail to prevent movement.
- Shift the transmission in gear (for models with a manual transmission).
- Secure the motorcycle with tie-downs or suitable straps that are attached to solid parts of the motorcycle, such as the frame or upper front fork triple clamp (and not, for example, to rubber-mounted handlebars or turn signals, or parts that could break). Choose the location for the straps carefully so the straps will not rub against painted surfaces during transport.
- The suspension should be compressed somewhat by the tie-downs, if possible, so that the motorcycle will not bounce excessively during transport.

Left view

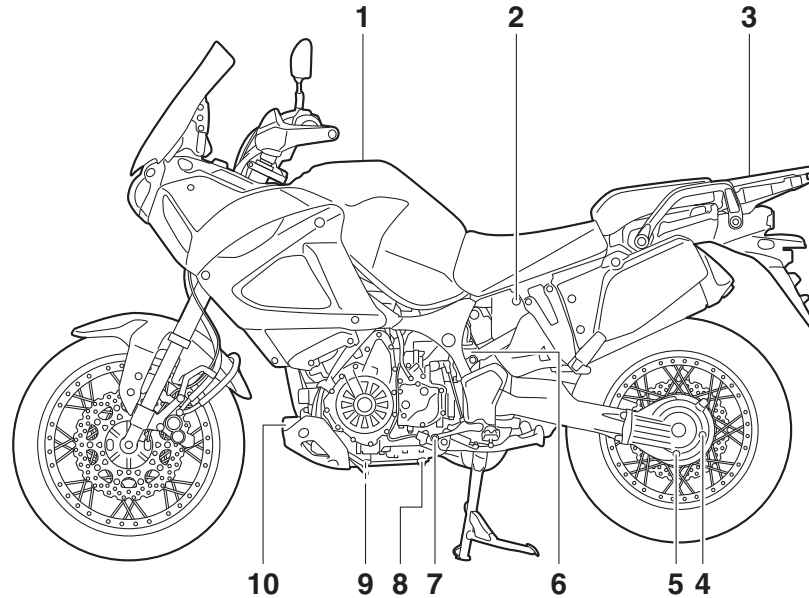

1. Fuel tank cap (page 3-31)

2. Seat lock (page 3-34)

3. Carrier (page 3-42)

4. Final gear oil filler bolt (page 6-14)

5. Final gear oil drain bolt (page 6-14)

6. Coolant reservoir (page 6-15)

7. Shift pedal (page 3-27)

8. Engine oil drain bolt (oil tank) (page 6-11)

9. Engine oil drain bolt (crankcase) (page 6-11)

10. Engine oil filter cartridge (page 6-11)

DESCRIPTION

EAU10421

Right view

2

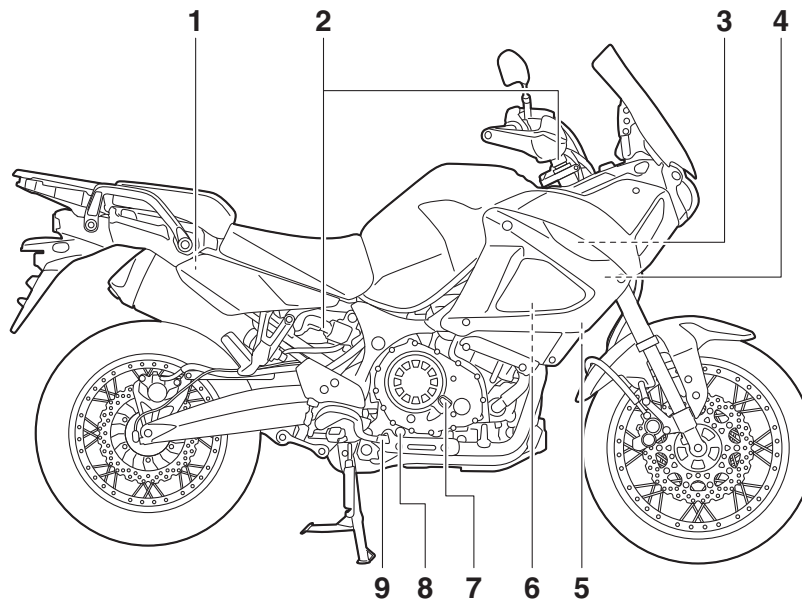

1. Rear brake fluid reservoir (page 6-23)

2. Electronically adjustable suspension system (page 3-37)

3. Fuses (page 6-30)

4. Fuse box (page 6-30)

5. Owner's tool kit (page 6-2)

6. Battery (page 6-28)

7. Engine oil filler cap (page 6-11)

8. Engine oil level check window (page 6-11)

9. Brake pedal (page 3-28)

Controls and instruments

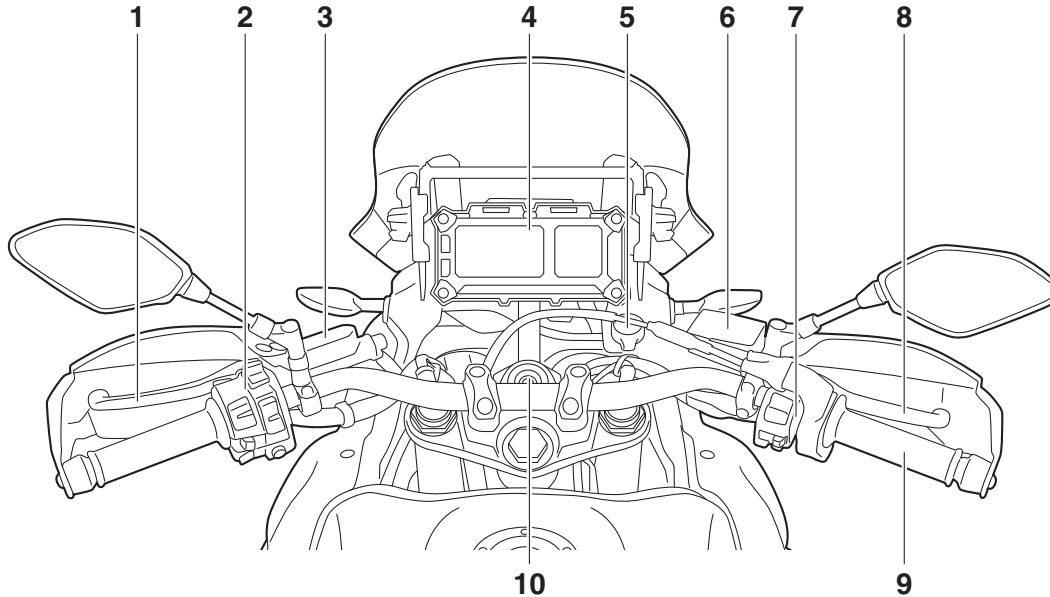

1. Clutch lever (page 3-26)

2. Left handlebar switches (page 3-24)

3. Clutch fluid reservoir (page 6-23)

4. Multi-function meter unit (page 3-10)

5. Auxiliary DC jack (page 3-45)

6. Front brake fluid reservoir (page 6-23)

7. Right handlebar switches (page 3-24)

8. Brake lever (page 3-27)

9. Throttle grip (page 6-17)

10. Main switch/steering lock (page 3-2)

INSTRUMENT AND CONTROL FUNCTIONS

Immobilizer system

EAU10978

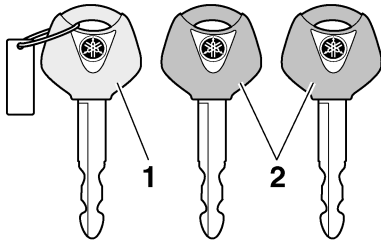

1. Code re-registering key (red bow)
2. Standard keys (black bow)

This vehicle is equipped with an immobilizer system to help prevent theft by re-registering codes in the standard keys. This system consists of the following:

- a code re-registering key (with a red bow)
- two standard keys (with a black bow) that can be re-registered with new codes
- a transponder (which is installed in the code re-registering key)
- an immobilizer unit
- an ECU

- an immobilizer system indicator light (See page 3-6.)

The key with the red bow is used to register codes in each standard key. Since re-registering is a difficult process, take the vehicle along with all three keys to a Yamaha dealer to have them re-registered. Do not use the key with the red bow for driving. It should only be used for re-registering the standard keys. Always use a standard key for driving.

ECA11822

NOTICE

- **DO NOT LOSE THE CODE RE-REGISTERING KEY! CONTACT YOUR DEALER IMMEDIATELY IF IT IS LOST!** If the code re-registering key is lost, registering new codes in the standard keys is impossible. The standard keys can still be used to start the vehicle, however if code re-registering is required (i.e., if a new standard key is made or all keys are lost) the entire immobilizer system must be replaced. Therefore, it is highly recom-

mended to use either standard key and keep the code re-registering key in a safe place.

- Do not submerge any key in water.
- Do not expose any key to excessively high temperatures.
- Do not place any key close to magnets (this includes, but not limited to, products such as speakers, etc.).
- Do not place items that transmit electrical signals close to any key.
- Do not place heavy items on any key.
- Do not grind any key or alter its shape.
- Do not disassemble the plastic part of any key.
- Do not put two keys of any immobilizer system on the same key ring.
- Keep the standard keys as well as keys of other immobilizer systems away from this vehicle's code re-registering key.

INSTRUMENT AND CONTROL FUNCTIONS

- Keep other immobilizer system keys away from the main switch as they may cause signal interference.

Main switch/steering lock

EAU10473

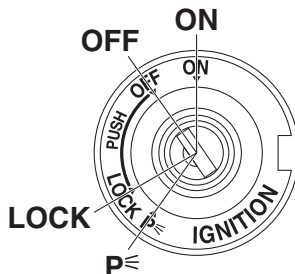

The main switch/steering lock controls the ignition and lighting systems, and is used to lock the steering. The various positions are described below.

TIP

Be sure to use the standard key (black bow) for regular use of the vehicle. To minimize the risk of losing the code re-registering key (red bow), keep it in a safe place and only use it for code re-registering.

ON

All electrical circuits are supplied with power; the meter lighting, taillights, license plate light and auxiliary lights come on, and the engine can be started. The key cannot be removed.

TIP

The headlights come on automatically when the engine is started and stay on until the key is turned to “OFF”.

OFF

All electrical systems are off. The key can be removed.

! WARNING

Never turn the key to “OFF” or “LOCK” while the vehicle is moving. Otherwise the electrical systems will be switched off, which may result in loss of control or an accident.

LOCK

The steering is locked, and all electrical systems are off. The key can be removed.

INSTRUMENT AND CONTROL FUNCTIONS

ECA20760

To lock the steering

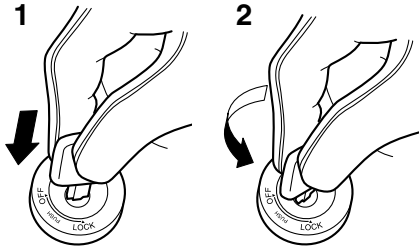

1. Push.
2. Turn.

1. Turn the handlebars all the way to the left or right.
2. Push the key in from the “OFF” position, and then turn it to “LOCK” while still pushing it.
3. Remove the key.

To unlock the steering

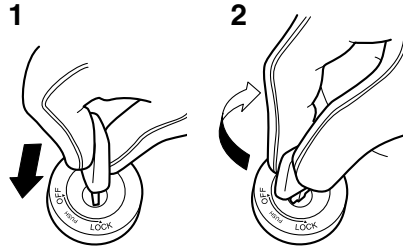

1. Push.
2. Turn.

Push the key into the main switch, and then turn it to “OFF” while still pushing it.

EAU59680

P (Parking)

The hazard lights and turn signal lights can be turned on, but all other electrical systems are off. The key can be removed.

The steering must be locked before the key can be turned to “P”.

NOTICE

Using the hazard or turn signal lights for an extended length of time may cause the battery to discharge.

INSTRUMENT AND CONTROL FUNCTIONS

Indicator lights and warning lights

EAU49397

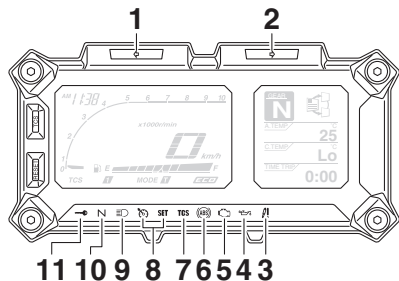

1. Left turn signal indicator light “◀”
2. Right turn signal indicator light “▶”
3. Electronically adjustable suspension system warning light “⚠”
4. Oil level warning light “⚠”
5. Engine trouble warning light “⚠”
6. Anti-lock Brake System (ABS) warning light “⊙”
7. Traction control system indicator/warning light “TCS”
8. Cruise control indicator lights
9. High beam indicator light “≡○”
10. Neutral indicator light “N”
11. Immobilizer system indicator light “→”

Turn signal indicator lights “◀” and “▶”

EAU11031

The corresponding indicator light flashes when the turn signal switch is pushed to the left or right.

Neutral indicator light “N”

EAU11061

This indicator light comes on when the transmission is in the neutral position.

High beam indicator light “≡○”

EAU11081

This indicator light comes on when the high beam of the headlight is switched on.

Oil level warning light “⚠”

EAU11255

This warning light comes on if the engine oil level is low.

The electrical circuit of the warning light can be checked by turning the key to “ON”. The warning light should come on for a few seconds, and then go off.

If the warning light does not come on initially when the key is turned to “ON”, or if the warning light remains on, have a Yamaha dealer check the electrical circuit.

TIP

- Even if the oil level is sufficient, the warning light may flicker when riding on a slope or during sudden acceleration or deceleration, but this is not a malfunction.
- This model is also equipped with a self-diagnosis device for the oil level detection circuit. If a problem is detected in the oil level detection circuit, the following cycle will be repeated until the malfunction is corrected: The oil level warning light will flash ten times, then go off for 2.5 seconds. If this occurs, have a Yamaha dealer check the vehicle.

Cruise control indicator lights

EAU58400

These indicator lights come on when the cruise control system is activated. See page 3-7 for a detailed explanation of the function of these indicator lights.

INSTRUMENT AND CONTROL FUNCTIONS

3

The electrical circuit of these indicator lights can be checked by turning the key to “ON”. These indicator lights should come on for a few seconds, and then go off.

If an indicator light does not come on initially when the key is turned to “ON”, or if an indicator light remains on, have a Yamaha dealer check the electrical circuit.

Engine trouble warning light “” EAU59110

This warning light comes on or flashes if a problem is detected in the electrical circuit monitoring the engine. If this occurs, have a Yamaha dealer check the self-diagnosis system. (See page 3-23 for an explanation of the self-diagnosis device.)

The electrical circuit of the warning light can be checked by turning the key to “ON”. The warning light should come on for a few seconds, and then go off.

If the warning light does not come on initially when the key is turned to “ON”, or if the warning light remains on, have a Yamaha dealer check the electrical circuit.

TIP

The engine trouble warning light will come on while the start switch is pushed, but this does not indicate a malfunction.

ABS warning light “” EAU59120

In normal operation, the ABS warning light comes on when the key is turned to “ON”, and goes off after traveling at a speed of 10 km/h (6 mi/h) or higher.

If the ABS warning light:

- does not come on when the key is turned to “ON”
- comes on or flashes while riding
- does not go off after traveling at a speed of 10 km/h (6 mi/h) or higher

The ABS may not work correctly. If any of the above occurs, have a Yamaha dealer check the system as soon as possible. (See page 3-28 for an explanation of the ABS.)

EWA16041

WARNING

If the ABS warning light does not go off after traveling at a speed of 10 km/h (6 mi/h) or higher, or if the warning light comes on or flashes while riding, the brake system reverts to conventional braking. If either of the above occurs, or if the warning light does not come on at all, use extra caution to avoid possible wheel lock during emergency braking. Have a Yamaha dealer check the brake system and electrical circuits as soon as possible.

TIP

The ABS warning light will also come on while the start switch is pushed, but this does not indicate a malfunction.

EAU58902

Traction control system indicator/warning light “TCS”

This indicator/warning light flashes when the traction control system engages.

The electrical circuit of the light can be checked by turning the key to “ON”. The light should come on for a few seconds, and then go off.

If the light does not come on initially when the key is turned to “ON”, or if the light remains on, have a Yamaha dealer check the electrical circuit.

If the traction control system becomes disabled while riding, “TCS OFF” is displayed, and the indicator/warning light and engine trouble warning light come on. (See page 3-29 for an explanation of the traction control system.)

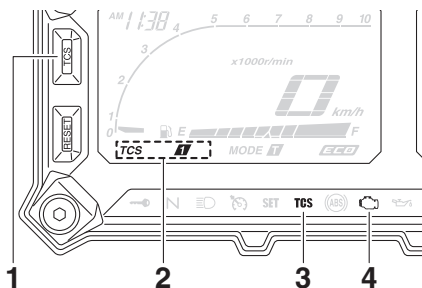

1. “TCS” button
2. Traction control system mode display
3. Traction control system indicator/warning light “TCS”
4. Engine trouble warning light “”

Reset the traction control system and the lights by following the procedures under “Resetting” on page 3-30.

Electronically adjustable suspension system warning light “”

EAU55392

This warning light comes on if a problem is detected in the electronically adjustable suspension system.

The electrical circuit of the warning light can be checked by turning the key to “ON”. The warning light should come on for a few seconds, and then go off.

If the warning light does not come on initially when the key is turned to “ON”, or if the warning light remains on, have a Yamaha dealer check the electrical circuit.

Immobilizer system indicator light “”

EAU54682

When the key is turned to “OFF” and 30 seconds have passed, the indicator light will start flashing indicating the immobilizer system is enabled. After 24

hours have passed, the indicator light will stop flashing, however the immobilizer system is still enabled.

The electrical circuit of the indicator light can be checked by turning the key to “ON”. The indicator light should come on for a few seconds, and then go off.

If the indicator light does not come on initially when the key is turned to “ON”, or if the indicator light remains on, have a Yamaha dealer check the electrical circuit.

The self-diagnosis device also detects problems in the immobilizer system circuits. (See page 3-23 for an explanation of the self-diagnosis device.)

INSTRUMENT AND CONTROL FUNCTIONS

EUAU59130

Cruise control system

This model is equipped with a cruise control system designed to maintain a set cruising speed.

The cruise control system operates only when riding in 3rd gear at speeds between about 50 km/h (31 mi/h) and 100 km/h (62 mi/h), 4th gear at speeds between about 50 km/h (31 mi/h) and 150 km/h (93 mi/h), or 5th or 6th gear at speeds between about 50 km/h (31 mi/h) and 180 km/h (112 mi/h).

EWA16341

WARNING

- **Improper use of the cruise control system may result in loss of control, which could lead to an accident. Do not activate the cruise control system in heavy traffic, poor weather conditions, or among winding, slippery, hilly, rough or gravel roads.**
- **When traveling uphill or downhill, the cruise control system may not be able to maintain the set cruising speed.**

- **To prevent accidentally activating the cruise control system, turn it off when not in use. Make sure that the cruise control system indicator light “A line drawing of the motorcycle instrument cluster. The speedometer is at the top with a needle and a 'km/h' label. Below it is a fuel gauge with 'E' and 'F' markings. At the bottom, there are several indicator lights: a 'TCS' light, a 'MODE' light, and a 'SET' light. A 'RES+/-' switch is also visible. Two callout lines point to the 'SET' light (labeled '1') and the 'RES+/-' switch (labeled '2').**

1. Cruise control system indicator light “A line drawing of the motorcycle handlebar controls. It shows the 'RES+/-' switch (labeled '1') and the 'RES+/-' switch (labeled '2').

1. Cruise control setting switch “RES+/-SET-”
2. Cruise control power switch “

Activating and setting the cruise control system

1. Push the cruise control power switch “

Adjusting the set cruising speed

While the cruise control system is operating, push the “RES+” side of the cruise control setting switch to increase the set cruising speed or the “SET-” side to decrease the set speed.

TIP

Pushing the setting switch once will change the speed in increments of approximately 2.0 km/h (1.2 mi/h). Holding the “RES+” or “SET-” side of the

INSTRUMENT AND CONTROL FUNCTIONS

cruise control setting switch down will increase or decrease the speed continuously until the switch is released.

You can also manually increase your traveling speed using the throttle. After you have accelerated, you can set a new cruising speed by pushing the “SET-” side of the setting switch. If you do not set a new cruising speed, when you return the throttle, the vehicle will decelerate to the previously set cruising speed.

Deactivating the cruise control system

Perform one of the following operations to cancel the set cruising speed. The “RES” indicator light will go off.

- Turn the throttle grip past the closed position in the deceleration direction.

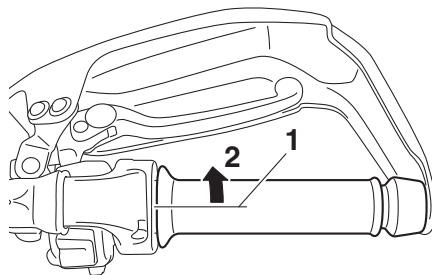

1. Closed position
2. Cruise control cancel direction

- Apply the front or rear brake.
- Disengage the clutch.

Push the power switch to turn off the cruise control system. The “RES” indicator light and the “SET” indicator light will go off.

TIP

Traveling speed decreases as soon as the cruise control system is deactivated; unless the throttle grip is turned.

Using the resume function

Push the “RES+” side of the cruise control setting switch to reactivate the cruise control system. The traveling

speed will return to the previously set cruising speed. The “SET” indicator light will come on.

EWA16351

⚠ WARNING

It is dangerous to use the resume function when the previously set cruising speed is too high for current conditions.

TIP

- The resume function operates when riding in 3rd gear at speeds between about 50 km/h (31 mi/h) and 100 km/h (62 mi/h), 4th gear at speeds between about 50 km/h (31 mi/h) and 150 km/h (93 mi/h), or 5th or 6th gear at speeds between about 50 km/h (31 mi/h) and 180 km/h (112 mi/h).
- Pushing the power switch while the system is operating will turn the system off completely and erase the previously set cruising speed. You will not be able to use the resume function until a new cruising speed has been set.

INSTRUMENT AND CONTROL FUNCTIONS

Automatic deactivation of the cruise control system

The cruise control system for this model is electronically controlled and is linked with the other control systems. The cruise control system will automatically become deactivated under the following conditions:

- The cruise control system is not able to maintain the set cruising speed.
- Wheel slip or wheel spin is detected. (If the traction control system has not been turned off, the traction control system will work.)
- The start/engine stop switch is set to the “” position.
- The engine stalls.
- The sidestand is lowered.

When traveling with a set cruising speed, if the cruise control system is deactivated under the above conditions, the “” indicator light will go off and the “SET” indicator light will flash for 4 seconds, and then go off.

When not traveling with a set cruising speed, if the start/engine stop switch is set to the “” position, the engine

stalls, or the sidestand is lowered, then the “” indicator light will go off (the “SET” indicator light will not flash).

If the cruise control system is automatically deactivated, please stop and confirm that your vehicle is in good operating condition.

Before using the cruise control system again, activate it using the power switch.

TIP



In some cases, the cruise control system may not be able to maintain the set cruising speed when the vehicle is traveling uphill or downhill.

- When the vehicle is traveling uphill, the actual traveling speed may become lower than the set cruising speed. If this occurs, accelerate to the desired traveling speed using the throttle.
- When the vehicle is traveling downhill, the actual traveling speed may become higher than the set cruising speed. If this occurs, the setting switch cannot be used to adjust the set cruising speed. To reduce the traveling

speed, apply the brakes. When the brakes are applied, the cruise control system will become deactivated.

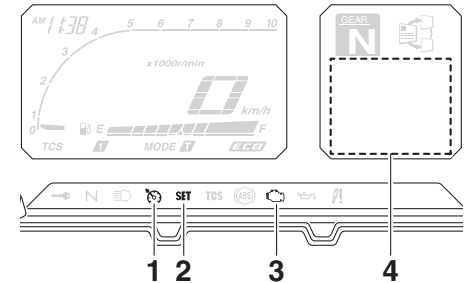
Self-diagnosis device



1. Cruise control system indicator light “”
2. Cruise control setting indicator light “SET”
3. Engine trouble warning light “”
4. Error code display

The cruise control system will also become deactivated when an irregularity with any of the vehicle systems is detected. The “SET” indicator light will go off and the “” indicator light will flash. You will not be able to use the cruise control system while the engine

INSTRUMENT AND CONTROL FUNCTIONS

trouble warning light is on, or while the cruise control system is malfunctioning.

WARNING

If the cruise control system is not working correctly, the “” indicator light will flash. If this occurs, turn the cruise control system off and have a Yamaha dealer check it.

EWA16361

NOTICE

If the display indicates an error code, the vehicle should be checked as soon as possible in order to avoid engine damage.

ECA11591

Multi-function meter unit

EAU58924

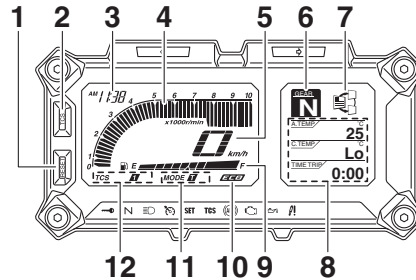

1. “RESET” button
2. “TCS” button
3. Clock
4. Tachometer
5. Speedometer
6. Transmission gear display
7. Function display
8. Information display
9. Fuel meter
10. Eco indicator “ECO”
11. Drive mode display
12. Traction control system mode display

WARNING

Be sure to stop the vehicle before making any setting changes to the multi-function meter unit. Changing

EWA12423

settings while riding can distract the operator and increase the risk of an accident.

TIP

The select switch “” and the menu switch “MENU” are located on the left handlebar. These switches allow you to control or change the settings of the multi-function meter unit.

3

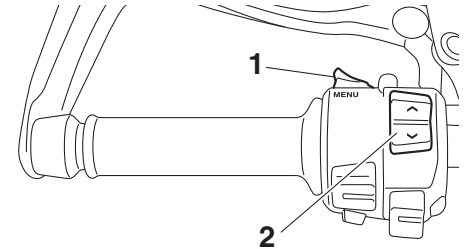

1. Menu switch “MENU”
2. Select switch “”

The multi-function meter unit is equipped with the following:

- a speedometer
- a tachometer
- a clock
- a fuel meter
- an eco indicator

INSTRUMENT AND CONTROL FUNCTIONS

3

- a transmission gear display
- a drive mode display (which shows the selected drive mode)
- a traction control system mode display (which shows the selected traction control system mode)
- a function display (which shows the selected function)
- an information display (which shows various information, such as the odometer reading)
- a setting mode display (which allows you to set, select, or reset the items shown in the information display)
- a self-diagnosis device

TIP

- Be sure to turn the key to “ON” before pushing the select switch “ \wedge/\vee ”, menu switch “MENU”, “RESET” button and “TCS” button.
- For the UK only: To switch the meter displays between kilometers and miles, see page 3-17.

Speedometer

The speedometer shows the vehicle’s traveling speed.

Tachometer

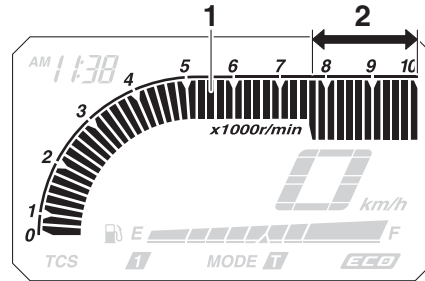

1. Tachometer
2. High-rpm zone

The electric tachometer allows the rider to monitor the engine speed and keep it within the ideal power range. When the key is turned to “ON”, the tachometer will sweep across the r/min range and then return to zero r/min in order to test the electrical circuit.

ECAM1150

NOTICE

Do not operate the engine in the tachometer high-rpm zone.

High-rpm zone: 7750 r/min and above

Fuel meter

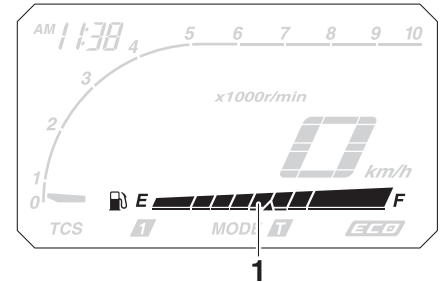

1. Fuel meter

The fuel meter indicates the amount of fuel in the fuel tank. The display segments of the fuel meter disappear towards “E” (Empty) as the fuel level decreases. When the last segment starts flashing, refuel as soon as possible.

When the key is turned to “ON”, all display segments come on once in order to test the electrical circuit.

INSTRUMENT AND CONTROL FUNCTIONS

TIP

This fuel meter is equipped with a self-diagnosis system. If a problem is detected in the electrical circuit, all display segments start flashing. If this occurs, have a Yamaha dealer check the electrical circuit.

Eco indicator

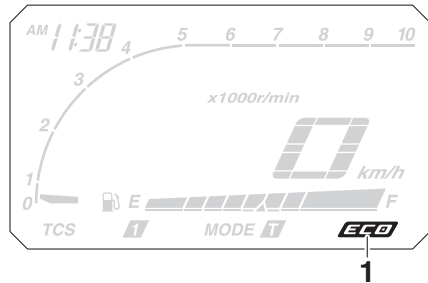

1. Eco indicator "ECO"

This indicator comes on when the vehicle is being operated in an environmentally friendly, fuel-efficient manner. The indicator goes off when the vehicle is stopped.

TIP

Consider the following tips to reduce fuel consumption:

- Avoid high engine speeds during acceleration.
- Travel at a constant speed.
- Select the transmission gear that is appropriate for the vehicle speed.

Transmission gear display

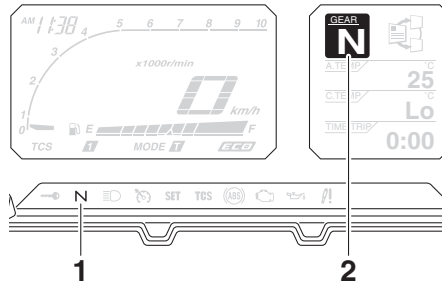

1. Neutral indicator light "N"
2. Transmission gear display

This display shows the selected gear. This model is equipped with 6 gears. The neutral position is indicated by the neutral indicator light "N" and by the transmission gear display "N". When the clutch lever is pulled or the vehicle is stopped, "—" will be displayed.

Drive mode display

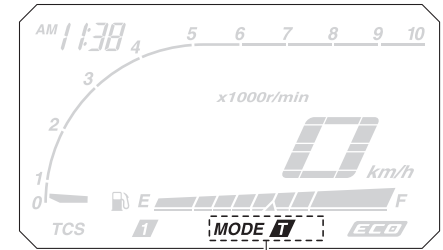

1. Drive mode display

This display indicates which drive mode has been selected: Touring mode "T" or sports mode "S". For more details on the modes and on how to select them, see pages 3-24 and 3-26.

INSTRUMENT AND CONTROL FUNCTIONS

3

Traction control system mode display

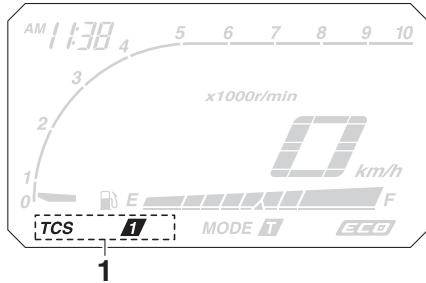

1. Traction control system mode display

This display indicates which traction control system mode has been selected: “1”, “2” or “OFF”. For more details on the modes and on how to select them, refer to page 3-29.

Function display

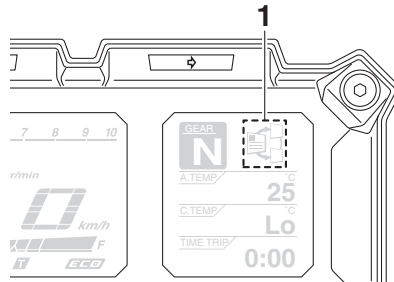

1. Function display

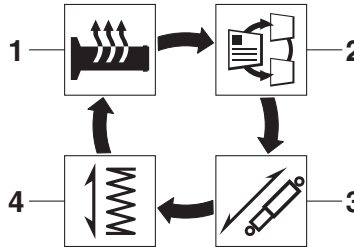

1. Grip warmer adjusting function
2. Information display selection function
3. Damping force adjusting function
4. Preload adjusting function

Push the menu switch “MENU” to switch the display between the following functions. The display changes each time the switch is pushed.

- Grip warmer adjusting function
- Information display selection function
- Damping force adjusting function
- Preload adjusting function

TIP

The preload adjusting function will appear only when the vehicle is stopped with the engine running.

The following pages contain explanation of the grip warmer and information display functions. See page 3-37 for an explanation of the preload and damping force adjusting functions.

Adjusting the grip warmer

This vehicle is equipped with grip warmers, which can only be used when the engine is running. There are 4 grip warmer settings.

INSTRUMENT AND CONTROL FUNCTIONS

Setting	Display
Off	
Low	
Middle	
High	

To increase the grip warmer temperature, push the “^” side of the select switch. To decrease the grip warmer temperature, push the “v” side of the select switch.

ECA17931

NOTICE

- Be sure to wear gloves when using the grip warmers.
- If the ambient temperature is 20 °C (68 °F) or higher, do not set the grip warmer to the high setting.
- If the handlebar grip or throttle grip becomes worn or damaged, stop using the grip warmers and replace the grips.

Selecting the information display

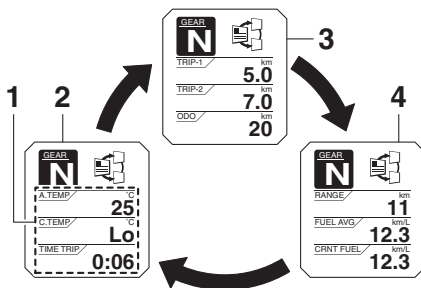

1. Information display
2. Display-1
3. Display-2
4. Display-3

There are 3 information displays. The selected information display can be switched by pushing the select switch. The following items are shown in the information displays:

- an odometer display
- tripmeter displays
- a fuel reserve tripmeter display
- an estimated traveling range display
- an elapsed time display
- an air intake temperature display
- a coolant temperature display

- an average fuel consumption display
- an instantaneous fuel consumption display

The items shown in each information display can be selected.

To set or select the items shown, see page 3-17.

Odometer display:

ODO / km
20

Tripmeter displays:

TRIP-1 / km
5.0

TRIP-2 / km
7.0

“TRIP-1” and “TRIP-2” show the distance traveled since they were last set to zero.

INSTRUMENT AND CONTROL FUNCTIONS

3

When approximately 3.9 L (1.03 US gal, 0.86 Imp.gal) of fuel remains in the fuel tank, the last segment of the fuel meter starts flashing. In addition, the information display will automatically change to the fuel reserve tripmeter mode “TRIP-F” and start counting the distance traveled from that point.

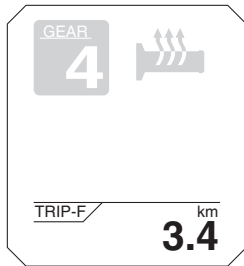

In that case, pushing the select switch switches the display between the various information displays in the following order;

TRIP-F → Display-1 → Display-2 → Display-3 → TRIP-F

To reset a tripmeter, use the select switch to select the information display that contains the tripmeter. Push the

“RESET” button briefly so that the tripmeter flashes, and then push the “RESET” button again for at least 2 seconds while the tripmeter is flashing. If you do not reset the fuel reserve tripmeter manually, it will reset itself automatically and the display will return to the prior mode after refueling and traveling 5 km (3 mi).

Estimated traveling range display:

RANGE / km
11

The distance that can be traveled with the remaining fuel in the fuel tank under the current riding conditions is shown.

Elapsed time display:

TIME TRIP /
0:06

The time that has elapsed since the key was turned to “ON” is shown. The maximum time that can be shown is 99:59.

This display is automatically reset when the key is turned to “OFF”.

TIP

There are also “TIME-2” and “TIME-3” elapsed time displays, but they cannot be set to the information display. See “Setting mode” on page 3-17 for detailed information.

Air intake temperature display:

A.TEMP / °C
25

The air intake temperature display indicates the temperature of the air drawn into the air filter case.

This display shows the air intake temperature from -9 °C to 93 °C in 1 °C increments. The temperature displayed may vary from the ambient temperature.

TIP

- -9 °C will be displayed even if the air intake temperature falls below -9 °C.

INSTRUMENT AND CONTROL FUNCTIONS

- The accuracy of the temperature reading may be affected when riding slowly [approximately under 20 km/h (12.5 mi/h)] or when stopped at traffic signals, railroad crossings, etc.

Coolant temperature display:



The coolant temperature display indicates the temperature of the coolant. The coolant temperature varies with changes in the weather and engine load.

If the message “Hi” flashes, stop the vehicle, then stop the engine, and let the engine cool. (See page 6-38.)

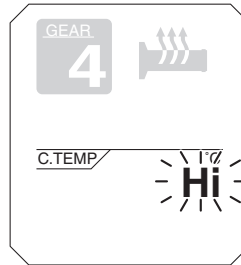

TIP

The selected information display cannot be switched while the message “Hi” is flashing.

ECA10022

NOTICE

Do not continue to operate the engine if it is overheating.

Average fuel consumption display:



The average fuel consumption display modes “km/L”, “L/100km” or “MPG” (for the UK only) show the average fuel consumption since the display was last reset.

- The “km/L” display shows the average distance that can be traveled on 1.0 L of fuel.
- The “L/100km” display shows the average amount of fuel necessary to travel 100 km.
- For the UK only: The “MPG” display shows the average distance that can be traveled on 1.0 Imp.gal of fuel.

To reset the average fuel consumption display, use the select switch to select the information display that contains the average fuel consumption display. Push the “RESET” button briefly so that the average fuel consumption display flashes, and then push the “RESET” button again for at least 2 seconds while the display is flashing.

INSTRUMENT AND CONTROL FUNCTIONS

3

TIP _____
After resetting the average fuel consumption display, “_ _.” will be shown for that display until the vehicle has traveled 1 km (0.6 mi).

ECA15474

NOTICE _____
If there is a malfunction, “- -.” will be continuously displayed. Have a Yamaha dealer check the vehicle.

Instantaneous fuel consumption display:

CRNT FUEL / km/L
12.3

The instantaneous fuel consumption display modes “km/L”, “L/100km” or “MPG” (for the UK only) show the fuel consumption under the current riding conditions.

- The “km/L” display shows the distance that can be traveled on 1.0 L of fuel.

- The “L/100km” display shows the amount of fuel necessary to travel 100 km.
- For the UK only: The “MPG” display shows the distance that can be traveled on 1.0 Imp.gal of fuel.

TIP _____
If traveling at speeds under 10 km/h (6 mi/h), “_ _.” will be displayed.

ECA15474

NOTICE _____
If there is a malfunction, “- -.” will be continuously displayed. Have a Yamaha dealer check the vehicle.

Setting mode

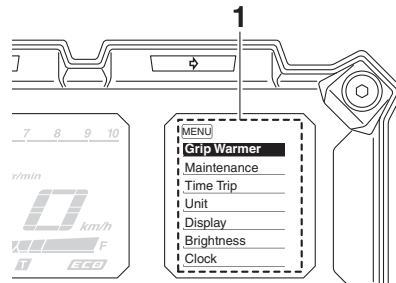

1. Setting mode display

- TIP** _____
- The transmission must be in neutral and the vehicle must be stopped to change settings in this mode.
 - Shifting the transmission into gear and starting off, or turning the key to “OFF”, saves all settings made, then exits the setting mode.

Push and hold the menu switch “MENU” for at least 2 seconds to enter the setting mode. To exit the setting mode and return to the normal display, push and hold the menu switch “MENU” again for at least 2 seconds.

Display	Description
Grip Warmer	This function allows you to set the low, middle, and high settings to 10 temperature levels.
Maintenance	This function allows you to check and reset the “OIL” oil change interval (distance traveled), and the “FREE-1” and “FREE-2” maintenance intervals.

INSTRUMENT AND CONTROL FUNCTIONS

Time Trip	This function allows you to check and reset the “TIME-2” and “TIME-3” functions. These time trips show the total elapsed time that the key has been in the “ON” position. When the key is turned to “OFF”, the time trips stop counting but are not reset. The maximum time that can be shown is 99:59. When the time trips reach 99:59, they automatically reset to 0:00 and continue counting.
Unit	This function allows you to switch the fuel consumption units between “L/100km” and “km/L”. For the UK only: This function allows you to switch the display units between kilometers and miles. When kilometers are selected, the fuel consumption units can be switched between “L/100km” and “km/L”.
Display	This function allows you to change the items shown in 3 information displays.
Brightness	This function allows you to adjust the brightness of the multi-function meter unit panel to suit the outside lighting conditions.

Clock	This function allows you to set the clock.
All Reset	This function allows you to reset all items, except the odometer and the clock.

Adjusting the temperature levels of the grip warmer settings

1. Use the select switch to highlight “Grip Warmer”.

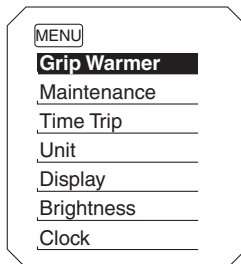

2. Push the menu switch “MENU”. The grip warmer setting display will be shown and “High” will flash in the display.

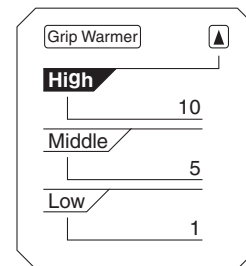

3. Push the menu switch “MENU”. The temperature level for the high setting will start flashing. Use the select switch to set the temperature level, and then push the menu switch “MENU”. “High” will start flashing.

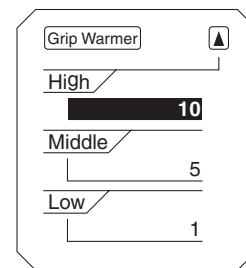

INSTRUMENT AND CONTROL FUNCTIONS

3

- Use the select switch to highlight “Middle” or “Low”, and then change the setting using the same procedure that was used for the high setting.
- When you are finished changing the settings, use the select switch to highlight “▲”, and then push the menu switch “MENU” to return to the setting mode menu.

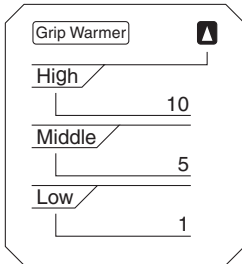

TIP
The setting can be set to 10 temperature levels.

Resetting the maintenance counters

- Use the select switch to highlight “Maintenance”.

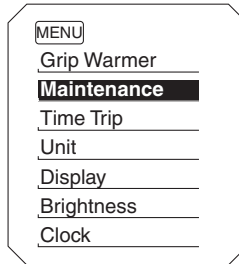

- Push the menu switch “MENU”, and then push the “RESET” button to select the item to reset.

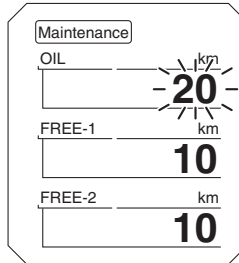

- While the selected item is flashing, push the “RESET” button for at least 2 seconds.
- Push the menu switch “MENU” to return to the setting mode menu.

Checking and resetting “TIME-2” and “TIME-3”

- Use the select switch to highlight “Time Trip”.

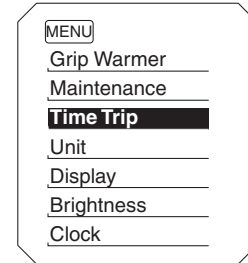

- Push the menu switch “MENU” to display “TIME-2” and “TIME-3”. To reset a time trip, push the “RESET” button to select the item to reset.

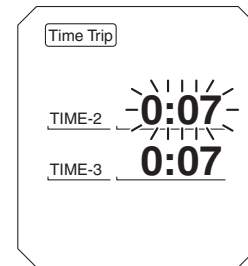

INSTRUMENT AND CONTROL FUNCTIONS

3. While the selected item is flashing, push the “RESET” button for at least 2 seconds.
4. Push the menu switch “MENU” to return to the setting mode menu.

Selecting the units

1. Use the select switch to highlight “Unit”.

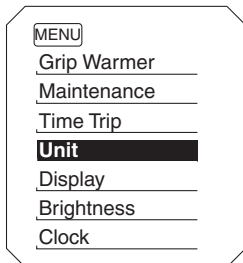

2. Push the menu switch “MENU”. The unit setting display will be shown and “km or mile” (for the UK only) or “km/L or L/100km” (except for the UK) will flash in the display.

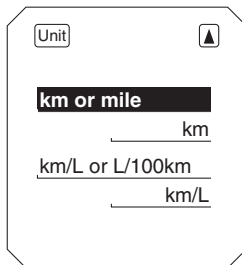

TIP

- For the UK: Continue with the following steps.
- Except for the UK: Skip steps 3–5.

3. Push the menu switch “MENU”. “km” or “mile” will flash in the display.

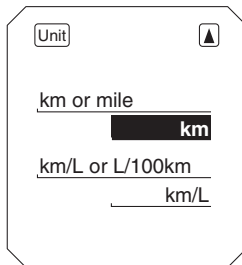

4. Use the select switch to select “km” or “mile”, and then push the menu switch “MENU”.

TIP

When “km” is selected, “L/100km” or “km/L” can be set as the fuel consumption units. To set the fuel consumption units, proceed as follows. If “mile” was selected, skip steps 5 and 6.

5. Use the select switch to select “km/L or L/100km”.
6. Push the menu switch “MENU”, use the select switch to select “L/100km” or “km/L”, and then push the menu switch “MENU” again.
7. Use the select switch to highlight “”, and then push the menu switch “MENU” to return to the setting mode menu.

INSTRUMENT AND CONTROL FUNCTIONS

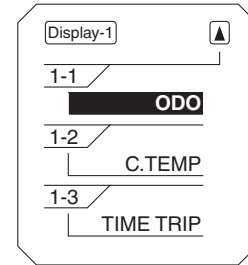
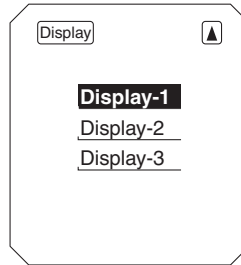
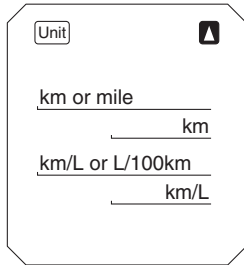

3

Selecting the display items

1. Use the select switch to highlight "Display".
2. Push the menu switch "MENU", use the select switch to highlight the display to change, and then push the menu switch "MENU" again.
3. Use the select switch to highlight the item to change, and then push the menu switch "MENU".
4. Use the select switch to select the item to show, and then push the menu switch "MENU".
5. When you are finished changing the settings, use the select switch to highlight "▲", and then push the menu switch "MENU" to return to the previous display.
6. Use the select switch to highlight "▲", and then push the menu switch "MENU" to return to the setting mode menu.

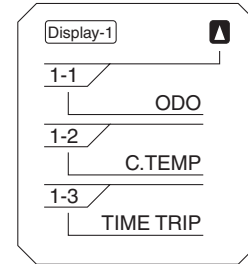
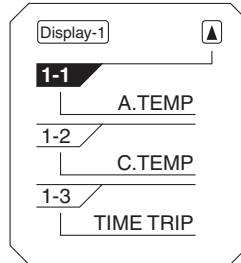
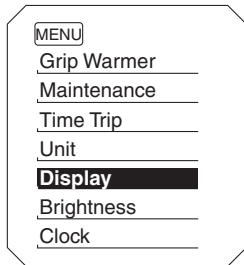

INSTRUMENT AND CONTROL FUNCTIONS

Adjusting the meter panel brightness

1. Use the select switch to highlight “Brightness”.

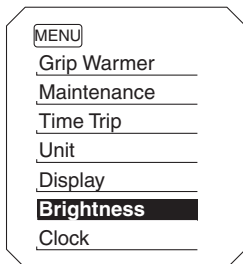

2. Push the menu switch “MENU”.
3. Use the select switch to select the desired brightness level, and then push the menu switch “MENU” to return to the setting mode menu.



Setting the clock

1. Use the select switch to highlight “Clock”.

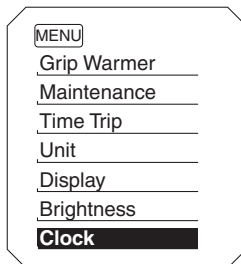

2. Push the menu switch “MENU”.
3. When the hour digits start flashing, use the select switch to set the hours.

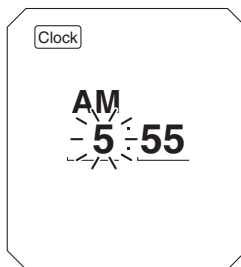

4. Push the menu switch “MENU”, and the minute digits start flashing.
5. Use the select switch to set the minutes.
6. Push the menu switch “MENU” to return to the setting mode menu.

Resetting all of the display items

1. Use the select switch to highlight “All Reset”.

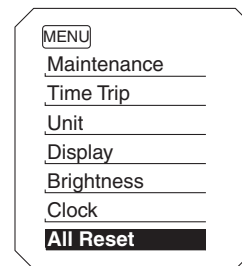

2. Push the menu switch “MENU”.
3. Use the select switch to highlight “YES”, and then push the menu switch “MENU”.

INSTRUMENT AND CONTROL FUNCTIONS

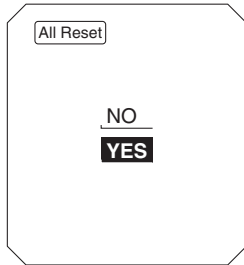



3

TIP

The odometer and the clock cannot be reset.

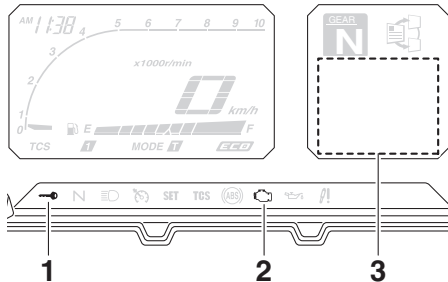
Self-diagnosis device



1. Immobilizer system indicator light “

This model is equipped with a self-diagnosis device for various electrical circuits. If a problem is detected in any of those circuits, the engine trouble warning light will come on and the information display will indicate an error code.

If the information display indicates any error codes, note the code number, and then have a Yamaha dealer check the vehicle.

The self-diagnosis device also detects problems in the immobilizer system circuits.

If a problem is detected in the immobilizer system circuits, the immobilizer system indicator light will flash and the information display will indicate an error code when the key is turned to “ON”.

TIP

If the information display indicates error code 52, this could be caused by transponder interference. If this error appears, try the following.

1. Use the code re-registering key to start the engine.

TIP

Make sure there are no other immobilizer keys close to the main switch, and do not keep more than one immobilizer key on the same key ring! Immobilizer system keys may cause signal interference, which may prevent the engine from starting.

2. If the engine starts, turn it off, and try starting the engine with the standard keys.
3. If one or both of the standard keys do not start the engine, take the vehicle, the code re-registering key and both standard keys to a Yamaha dealer and have the standard keys re-registered.

ECA11591

NOTICE

If the display indicates an error code, the vehicle should be checked as soon as possible in order to avoid engine damage.

D-mode (drive mode)

EAU49432

D-mode is an electronically controlled engine performance system with two mode selections (touring mode “T” and sports mode “S”).

Push the drive mode switch “MODE” to switch between modes. (See page 3-26 for an explanation of the drive mode switch.)

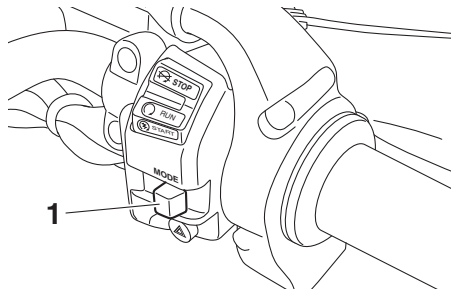

1. Drive mode switch “MODE”

TIP

Before using D-mode, make sure you understand its operation along with the operation of the drive mode switch.

Touring mode “T”

The touring mode “T” is suitable for various riding conditions.

This mode allows the rider to enjoy smooth drivability from the low-speed range to the high-speed range.

Sports mode “S”

This mode offers a sportier engine response in the low- to mid-speed range compared to the touring mode.

Handlebar switches

EAU1234H

Left

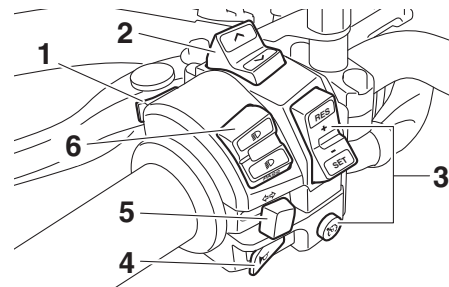

1. Menu switch “MENU”
2. Select switch “ \wedge / \vee ”
3. Cruise control switches
4. Horn switch “”
5. Turn signal switch “ \leftarrow / \rightarrow ”
6. Dimmer/Pass switch “ \equiv / \equiv /PASS”

INSTRUMENT AND CONTROL FUNCTIONS

Right

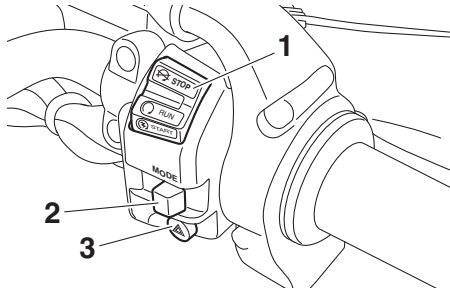

1. Start/Engine stop switch “”
2. Drive mode switch “MODE”
3. Hazard switch “”

Dimmer/Pass switch “/PASS”

EAU54201

Set this switch to “” for the high beam and to “” for the low beam. To flash the high beam, push the pass side “PASS” of the switch while the headlights are on low beam.

Turn signal switch “”

EAU12461

To signal a right-hand turn, push this switch to “”. To signal a left-hand turn, push this switch to “”. When released, the switch returns to the cen-

ter position. To cancel the turn signal lights, push the switch in after it has returned to the center position.

EAU12501

Horn switch “”

Press this switch to sound the horn.

EAU54211

Start/Engine stop switch “”

To crank the engine with the starter, set this switch to “”, and then push the “” side of the switch. See page 5-1 for starting instructions prior to starting the engine.

Set this switch to “” to stop the engine in case of an emergency, such as when the vehicle overturns or when the throttle cable is stuck.

EAU42342

The engine trouble warning light and ABS warning light may come on when the key is turned to “ON” and the start switch is pushed, but this does not indicate a malfunction.

EAU12735

Hazard switch “”

With the key in the “ON” or “” position, use this switch to turn on the hazard lights (simultaneous flashing of all turn signal lights).

The hazard lights are used in case of an emergency or to warn other drivers when your vehicle is stopped where it might be a traffic hazard.

ECA10062

NOTICE

Do not use the hazard lights for an extended length of time with the engine not running, otherwise the battery may discharge.

EAU12781

Cruise control switches

See page 3-7 for an explanation of the cruise control system.

EAU54231

Menu switch “MENU”

This switch is used to perform selections in the function display and setting mode display of the multi-function meter unit.

See “Multi-function meter unit” on page 3-10 for detailed information.

Select switch “ \wedge/\vee ”

EAU54221

This switch is used to perform selections in the function display and setting mode display of the multi-function meter unit.

See “Multi-function meter unit” on page 3-10 for detailed information.

Drive mode switch “MODE”

EAU54691

EWA15341



WARNING

Do not change the D-mode while the vehicle is moving.

Using this switch changes the drive mode to touring mode “T” or sports mode “S”.

The throttle grip must be completely closed in order to change the drive mode.

The selected mode is shown on the drive mode display. (See page 3-12.)

The drive mode cannot be changed while the cruise control system is operating.

Clutch lever

EAU12831

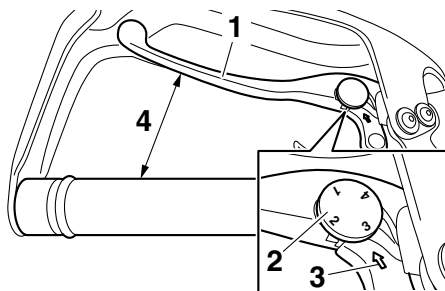

1. Clutch lever
2. Clutch lever position adjusting dial
3. Arrow mark
4. Distance between clutch lever and handlebar grip

The clutch lever is located at the left handlebar grip. To disengage the clutch, pull the lever toward the handlebar grip. To engage the clutch, release the lever. The lever should be pulled rapidly and released slowly for smooth clutch operation.

The clutch lever is equipped with a clutch lever position adjusting dial. To adjust the distance between the clutch lever and the handlebar grip, turn the adjusting dial while holding the lever pushed away from the handlebar grip.

Make sure that the appropriate setting on the adjusting dial is aligned with the arrow mark on the clutch lever.

The clutch lever is equipped with a clutch switch, which is part of the ignition circuit cut-off system. (See page 3-43.)

INSTRUMENT AND CONTROL FUNCTIONS

3

Shift pedal

EAU12872

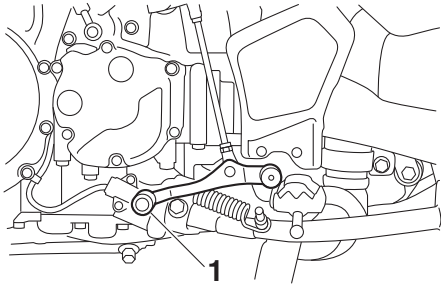

1. Shift pedal

The shift pedal is located on the left side of the motorcycle and is used in combination with the clutch lever when shifting the gears of the 6-speed constant-mesh transmission equipped on this motorcycle.

Brake lever

EAU49518

The brake lever is located on the right side of the handlebar. To apply the front brake, pull the lever toward the throttle grip.

This model is equipped with a unified brake system.

When pulling the brake lever, the front brake and a portion of the rear brake are applied. For full braking performance, apply both the brake lever and the brake pedal simultaneously.

The unified brake system is monitored by an ECU, which disables unified braking and resumes conventional braking if a malfunction occurs.

TIP

- Resistance and vibration may be felt in the brake pedal while the front brake is being applied and the unified brake system is enabled, but this does not indicate a malfunction.
- The unified brake system does not function until the vehicle starts moving.

- After coming to a stop while applying the brake lever, the unified brake system is still enabled. As further squeezing of the brake lever will not increase the braking power of the rear brake, apply the rear brake should further braking power be necessary (such as when parking on a slope).

The unified brake system disables after the brake lever is released. The brake system then reverts to the conventional type.

When the vehicle starts moving, the unified brake system is re-enabled.

- The unified brake system does not function when the brake pedal is applied alone or before the brake lever is applied.

The brake lever is equipped with a brake lever position adjusting dial. To adjust the distance between the brake lever and the throttle grip, turn the adjusting dial while holding the lever pushed away from the throttle grip.

Make sure that the appropriate setting on the adjusting dial is aligned with the “△” mark on the brake lever.

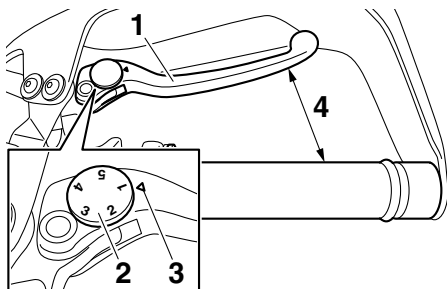

1. Brake lever
2. Brake lever position adjusting dial
3. “△” mark
4. Distance between brake lever and throttle grip

Brake pedal

EAU49482

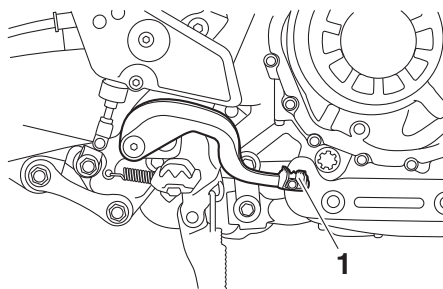

1. Brake pedal

The brake pedal is on the right side of the motorcycle. To apply the rear brake, press down on the brake pedal.

TIP

Resistance and vibration may be felt in the brake pedal while the front brake is being applied and the unified brake system is enabled, but this does not indicate a malfunction.

ABS

EAU54532

The Yamaha ABS (Anti-lock Brake System) features a dual electronic control system, which acts on the front and rear brakes independently.

Operate the brakes with ABS as you would conventional brakes. If the ABS is activated, a pulsating sensation may be felt at the brake lever or brake pedal. In this situation, continue to apply the brakes and let the ABS work; do not “pump” the brakes as this will reduce braking effectiveness.

3

WARNING

Always keep a sufficient distance from the vehicle ahead to match the riding speed even with ABS.

- The ABS performs best with long braking distances.
- On certain surfaces, such as rough or gravel roads, the braking distance may be longer with the ABS than without.

The ABS is monitored by an ECU, which will revert the system to conventional braking if a malfunction occurs.

EWA16051

INSTRUMENT AND CONTROL FUNCTIONS

3

TIP

- The ABS performs a self-diagnosis test each time the vehicle first starts off after the key is turned on and the vehicle has traveled at a speed of 10 km/h (6 mi/h) or higher. During this test, a “clicking” noise can be heard from under the seat, and if the brake lever or brake pedal is even slightly applied, a vibration can be felt at the lever and pedal, but these do not indicate a malfunction.
- This ABS has a test mode which allows the owner to experience the pulsation at the brake lever or brake pedal when the ABS is operating. However, special tools are required, so please consult your Yamaha dealer.

ECA16831

NOTICE

Keep any type of magnets (including magnetic pick-up tools, magnetic screwdrivers, etc.) away from the front and rear wheel hubs; otherwise, the magnetic rotors equipped in the wheel hubs may be damaged,

resulting in improper performance of the ABS and the unified brake system.

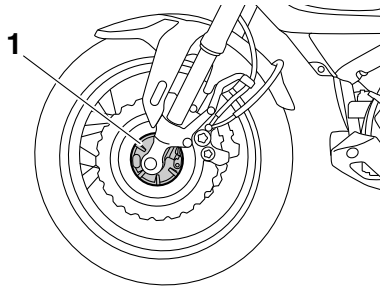

1. Front wheel hub

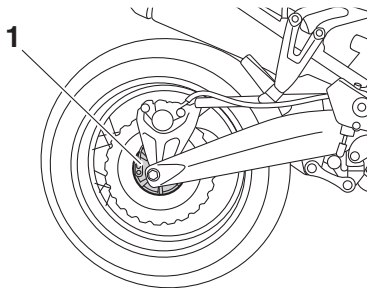

1. Rear wheel hub

EAU58942

Traction control system

The traction control system helps maintain traction when accelerating on slippery surfaces, such as unpaved or wet roads. If sensors detect that the rear wheel is starting to slip (uncontrolled spinning), the traction control system assists by regulating engine power as needed until traction is restored. The traction control system indicator/warning light flashes to let the rider know that traction control has engaged.

TIP

The rider may also notice slight changes in engine and exhaust sounds when the traction control system is engaged.

EWA15432

WARNING

The traction control system is not a substitute for riding appropriately for the conditions. Traction control cannot prevent loss of traction due to excessive speed when entering turns, when accelerating hard at a sharp lean angle, or while braking, and cannot prevent front wheel slip-

INSTRUMENT AND CONTROL FUNCTIONS

ping. As with any motorcycle, approach surfaces that may be slippery with caution and avoid especially slippery surfaces.

There are three traction control system modes:

- “TCS 1”: Default mode
- “TCS 2”: Sporty mode
This mode decreases traction control system assist, allowing the rear wheel to spin more freely than “TCS 1”.
- “TCS OFF”: The traction control system is turned off. The system may also be automatically disabled in some riding conditions (see “Resetting” on page 3-30).

When the key is turned to “ON”, the traction control system is enabled and “TCS 1” is displayed in the multi-function meter.

The traction control system mode can be changed only when the key is in the “ON” position and the vehicle is not moving.

TIP

Use the mode “TCS OFF” to help free the rear wheel if the motorcycle gets stuck in mud, sand, or other soft surfaces.

NOTICE

Use only the specified tires. (See page 6-18.) Using different sized tires will prevent the traction control system from controlling tire rotation accurately.

Setting the traction control system

WARNING

Be sure to stop the vehicle before making any setting changes to the traction control system. Changing settings while riding can distract the operator and increase the risk of an accident.

Push the “TCS” button on the multi-function meter for less than one second to change between the modes “1” and “2”. Push the button for at least two seconds to select the mode “TCS

OFF” and turn the traction control system off. Push the button again to return to the previously selected mode “1” or “2”.

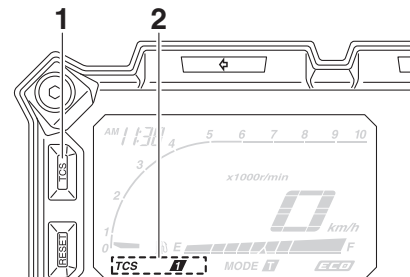

1. “TCS” button
2. Traction control system mode display

Resetting

The traction control system will be disabled in the following conditions:

- The rear wheel is rotated with the centerstand down and the key in the “ON” position.
- Either the front wheel or rear wheel comes off the ground while riding.
- Excessive rear wheel spinning

INSTRUMENT AND CONTROL FUNCTIONS

If the traction control system has been disabled, both the traction control system indicator/warning light and the engine trouble warning light come on.

3

To reset the traction control system:

Turn the key to “OFF”. Wait at least one second, then turn the key back to “ON”. The traction control system indicator/warning light should go off and the system will be enabled. The engine trouble warning light should go off after the motorcycle reaches at least 20 km/h (12 mi/h). If the traction control system indicator/warning light or the engine trouble warning light remains on after resetting, the motorcycle may still be ridden; however, have a Yamaha dealer check the motorcycle as soon as possible.

Fuel tank cap

EAU13075

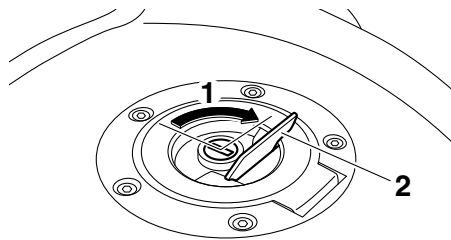

1. Unlock.
2. Fuel tank cap lock cover

To open the fuel tank cap

Open the fuel tank cap lock cover, insert the key into the lock, and then turn it 1/4 turn clockwise. The lock will be released and the fuel tank cap can be opened.

To close the fuel tank cap

1. Push the fuel tank cap into position with the key inserted in the lock.
2. Turn the key counterclockwise to the original position, remove it, and then close the lock cover.

TIP

The fuel tank cap cannot be closed unless the key is in the lock. In addition, the key cannot be removed if the cap is not properly closed and locked.

EWA11092

! WARNING

Make sure that the fuel tank cap is properly closed after filling fuel. Leaking fuel is a fire hazard.

INSTRUMENT AND CONTROL FUNCTIONS

Fuel

Make sure there is sufficient gasoline in the tank.

EAU13222

EWA10882

WARNING

Gasoline and gasoline vapors are extremely flammable. To avoid fires and explosions and to reduce the risk of injury when refueling, follow these instructions.

1. Before refueling, turn off the engine and be sure that no one is sitting on the vehicle. Never refuel while smoking, or while in the vicinity of sparks, open flames, or other sources of ignition such as the pilot lights of water heaters and clothes dryers.
2. Do not overfill the fuel tank. When refueling, be sure to insert the pump nozzle into the fuel tank filler hole. Stop filling when the fuel reaches the bottom of the filler tube. Because fuel expands when it heats up, heat from the engine or the sun can cause fuel to spill out of the fuel tank.

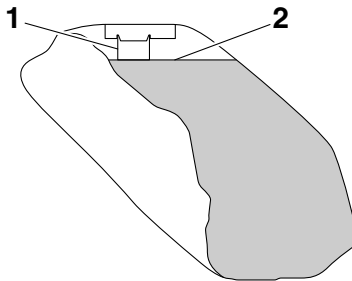

1. Fuel tank filler tube
2. Maximum fuel level
3. Wipe up any spilled fuel immediately. **NOTICE: Immediately wipe off spilled fuel with a clean, dry, soft cloth, since fuel may deteriorate painted surfaces or plastic parts.** [ECA110072]
4. Be sure to securely close the fuel tank cap.

EWA15152

WARNING

Gasoline is poisonous and can cause injury or death. Handle gasoline with care. Never siphon gasoline by mouth. If you should swallow some gasoline or inhale a lot of gasoline vapor, or get some gasoline in your eyes, see your doctor immedi-

ately. If gasoline spills on your skin, wash with soap and water. If gasoline spills on your clothing, change your clothes.

EAU58110

3

Recommended fuel:

Premium unleaded gasoline (Gasohol (E10) acceptable)

Fuel tank capacity:

23.0 L (6.08 US gal, 5.06 Imp.gal)

Fuel reserve amount:

3.9 L (1.03 US gal, 0.86 Imp.gal)

ECA11401

NOTICE

Use only unleaded gasoline. The use of leaded gasoline will cause severe damage to internal engine parts, such as the valves and piston rings, as well as to the exhaust system.

Your Yamaha engine has been designed to use premium unleaded gasoline with a research octane number of 95 or higher. If knocking (or pinging) occurs, use a gasoline of a different

INSTRUMENT AND CONTROL FUNCTIONS

brand. Use of unleaded fuel will extend spark plug life and reduce maintenance costs.

Gasohol

There are two types of gasohol: gasohol containing ethanol and that containing methanol. Gasohol containing ethanol can be used if the ethanol content does not exceed 10% (E10). Gasohol containing methanol is not recommended by Yamaha because it can cause damage to the fuel system or vehicle performance problems.

Fuel tank breather hose and overflow hose

EAU51152

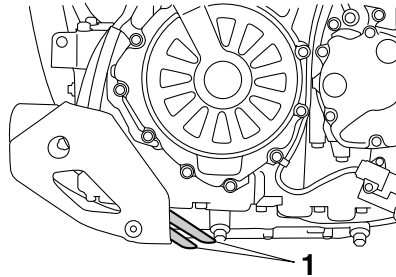

1. Fuel tank breather hose and overflow hose

Before operating the motorcycle:

- Check each hose connection.
- Check each hose for cracks or damage, and replace if necessary.
- Make sure that the end of each hose is not blocked, and clean if necessary.
- Make sure that the end of each hose is positioned outside of the cowl.

Catalytic converter

EAU13434

This model is equipped with a catalytic converter in the exhaust system.

EWA10863

WARNING

The exhaust system is hot after operation. To prevent a fire hazard or burns:

- Do not park the vehicle near possible fire hazards such as grass or other materials that easily burn.
- Park the vehicle in a place where pedestrians or children are not likely to touch the hot exhaust system.
- Make sure that the exhaust system has cooled down before doing any maintenance work.
- Do not allow the engine to idle more than a few minutes. Long idling can cause a build-up of heat.

INSTRUMENT AND CONTROL FUNCTIONS

NOTICE

Use only unleaded gasoline. The use of leaded gasoline will cause unrepairable damage to the catalytic converter.

ECA10702

Rider seat

EAU49444

To remove the rider seat

1. Insert the key into the seat lock, and then turn it counterclockwise.

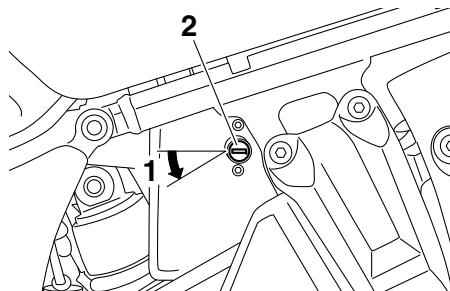

1. Unlock.
2. Seat lock

2. Lift the front of the rider seat and push the seat forward.

To install the rider seat

1. Insert the projection on the rear of the rider seat into the seat holder as shown, and then push the front of the seat down to lock it in place.

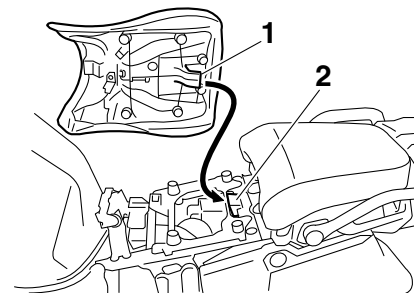

1. Projection
2. Seat holder

2. Remove the key.

TIP

- Make sure that the rider seat is properly secured before riding.
- The rider seat height can be adjusted to change the riding position. (See “Adjusting the rider seat height”.)

INSTRUMENT AND CONTROL FUNCTIONS

EAU49475

Adjusting the rider seat height

The rider seat height can be adjusted to one of two positions to suit the rider's preference.

The rider seat height was adjusted to the higher position at delivery.

3

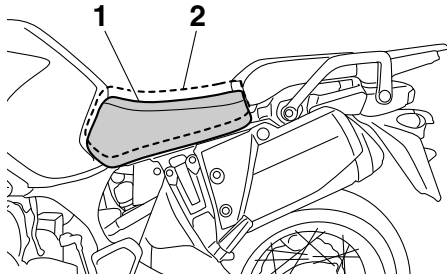

1. Low position
2. High position

To change the rider seat height to the low position

1. Remove the rider seat. (See page 3-34.)
2. Remove the rider seat height position adjuster by pulling it out.

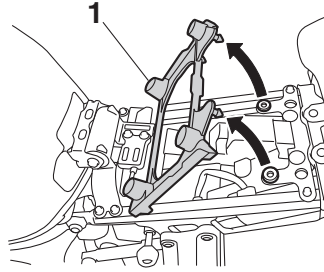

1. Rider seat height position adjuster

3. Install the rider seat height position adjuster so that the match mark is aligned with the "L" mark as shown.

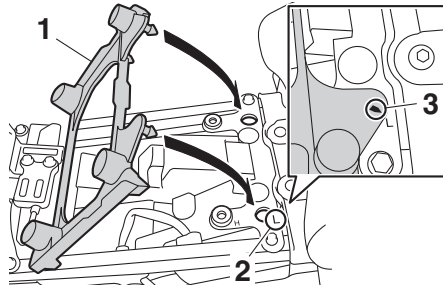

1. Rider seat height position adjuster
2. "L" mark
3. Match mark

4. Insert the projection on the rear of the rider seat into seat holder A as shown.

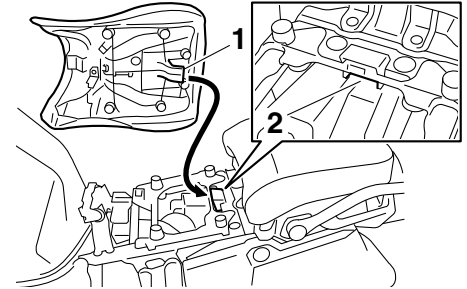

1. Projection
2. Seat holder A (for low position)

To change the rider seat height to the high position

1. Remove the rider seat. (See page 3-34.)
2. Remove the rider seat height position adjuster by pulling it out.

INSTRUMENT AND CONTROL FUNCTIONS

EAU58982

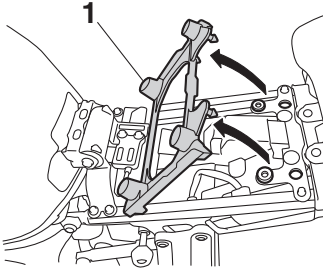

1. Rider seat height position adjuster

3. Install the rider seat height position adjuster so that the match mark is aligned with the “H” mark as shown.

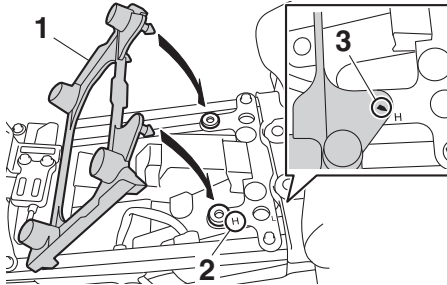

1. Rider seat height position adjuster
2. “H” mark
3. Match mark

4. Insert the projection on the rear of the rider seat into seat holder B as shown.

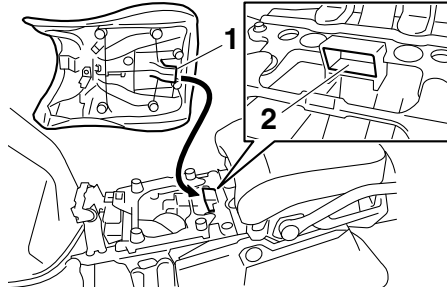

1. Projection
2. Seat holder B (for high position)

TIP

Make sure that the rider seat is properly secured before riding.

Windshield

To suit the rider’s preference, the windshield can be changed to one of four positions.

To adjust the windshield height

1. Loosen the windshield height position adjusting knob on each side of the windshield until resistance is felt. **NOTICE: Do not continue turning the knob after resistance is felt. Otherwise, the knob could be damaged.** [ECA20211]

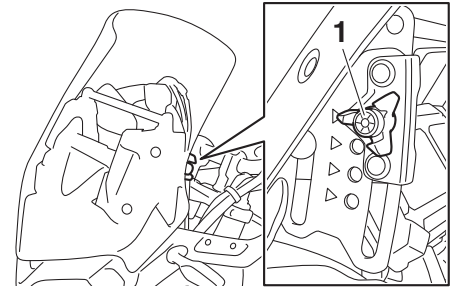

1. Windshield height position adjusting knob
2. Pull the slide plate holders outward, and then adjust the height of the windshield.

INSTRUMENT AND CONTROL FUNCTIONS

3

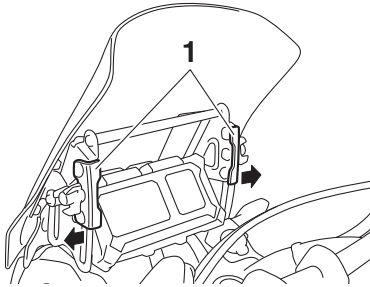

1. Slide plate holder

3. Align the slide plate holders with the match marks at the desired position.

TIP

- Make sure that the slide plate holders are aligned with the match marks at the same height on both sides of the windshield.
- Make sure that the projection on each slide plate holder fits into the corresponding hole in the slide plate.

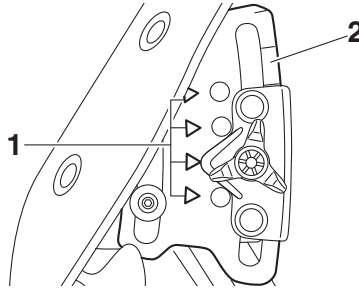

1. Match mark

2. Slide plate

4. Tighten the adjusting knobs.

EAU55424

Adjusting the front and rear suspension

This model is equipped with an electronically adjustable suspension system. The preload of the rear shock absorber and the damping forces of both the front fork and rear shock absorber can be adjusted.

EWA12423

⚠ WARNING

Be sure to stop the vehicle before making any setting changes to the multi-function meter unit. Changing settings while riding can distract the operator and increase the risk of an accident.

Preload

When riding with luggage or a passenger, use the preload adjusting function to adjust the suspension system to match the load. There are 4 preload settings.

TIP

- The preload adjusting function will appear only when the engine is running.

INSTRUMENT AND CONTROL FUNCTIONS

- Changing the preload setting will also adjust the front and rear suspension damping forces accordingly. See “Damping force” on page 3-40 for more information.
- About cold temperature operation:
 - When using the preload adjusting function, there should be no weight on the vehicle.
 - When using the preload adjusting function at ambient temperatures near or below 0 °C (32 °F), to protect the preload adjusting function motor, the electronically adjustable suspension system warning light may come on.
 - The suspension will still operate as normal, only the preload adjusting function cannot be used.
 - To reset the electronically adjustable suspension system warning light, wait approximately 6 minutes and then turn the key to “OFF” or immediately turn the key to “OFF” and then wait 6 minutes.

- If the electronically adjustable suspension system warning light remains on, have a Yamaha dealer check the suspension system.

To adjust the preload

1. Turn the key to “ON”, start the engine, and then shift the transmission into neutral.
2. Push the menu switch “MENU” to switch the function display to the preload adjusting function.

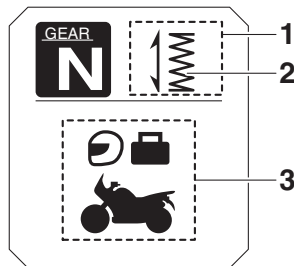

1. Function display
2. Preload adjusting function
3. Preload setting pictogram

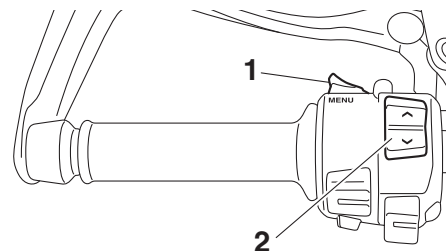

1. Menu switch “MENU”
2. Select switch “ \wedge/\vee ”
3. Use the select switch to select the desired preload setting pictogram. Select the suitable setting from the following 4 pictograms according to your load condition.

INSTRUMENT AND CONTROL FUNCTIONS

3

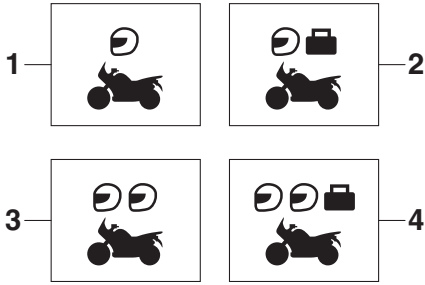

1. Solo riding
2. Solo riding and luggage
3. Passenger riding
4. Passenger riding and luggage

While the preload is being adjusted, the information display will show a group of dots moving in a circle. Once the selected pictogram returns, the preload adjustment is complete.

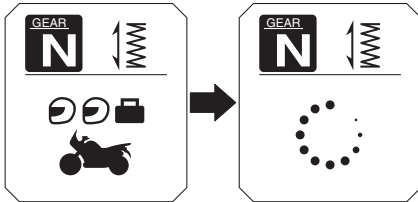

While the preload is being adjusted, the information display may change as follows.

- If the key is turned to “OFF” or the engine is stopped while the preload is being set, the following preload setting pictogram will flash to alert you that the current preload setting does not match the pictogram. If this occurs, adjust the preload again.

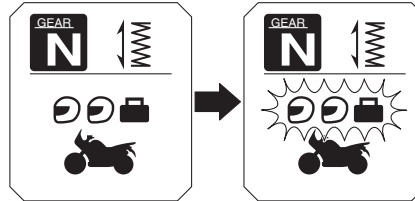

- If the vehicle starts moving, the following preload setting pictogram will flash to alert you that the current preload setting does not match the pictogram. If this occurs, stop the vehicle and adjust the preload again.

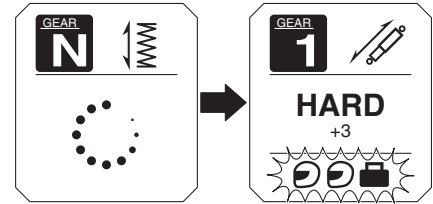

- If the preload is adjusted repeatedly, the preload setting pictogram will flash 4 times and the preload cannot be adjusted. Wait approximately 6 minutes for the preload adjusting function motor to cool down, and then try adjusting the preload again.

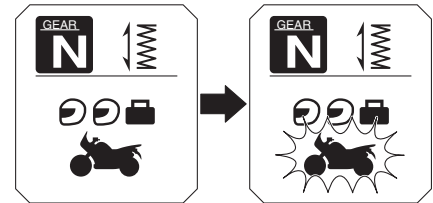

INSTRUMENT AND CONTROL FUNCTIONS

Damping force

Within each preload setting there are 3 damping force settings: “HARD” (hard), “STD” (standard) and “SOFT” (soft). When the preload setting is changed, the damping force settings will change accordingly. (The electronically adjustable suspension system will automatically adjust to the damping force settings last set for that preload setting.) To further finely adjust the damping force, each damping force setting can be set to 7 different levels.

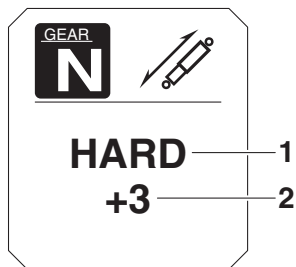

1. Damping force setting
2. Damping force setting level

TIP

If the preload setting was not completed correctly:

- The damping force setting and setting level will flash 4 times and cannot be adjusted if you try to adjust them while the vehicle is stopped.
- The preload setting pictogram will flash and the damping force cannot be adjusted if you try to adjust it while the vehicle is moving.

Be sure that the preload has been set correctly before adjusting the damping force.

To adjust the damping force and damping force setting level

1. Turn the key to “ON”.
2. Push the menu switch “MENU” to switch the function display to the damping force adjusting function.

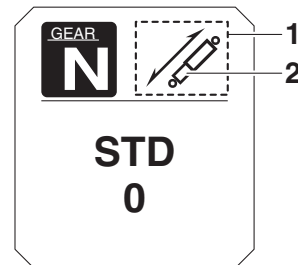

1. Function display
2. Damping force adjusting function
3. Use the select switch to select “HARD”, “STD” or “SOFT”.



1. Damping force setting
4. Push the menu switch “MENU”.
5. Use the select switch to select the desired level for the damping force setting.

INSTRUMENT AND CONTROL FUNCTIONS

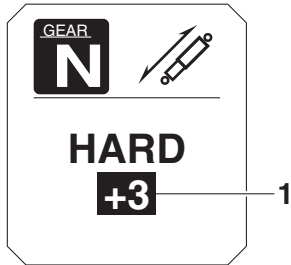

1. Damping force setting level

TIP

The damping force setting can be set to 7 levels (+3, +2, +1, 0, -1, -2 and -3). “+3” is the hardest level and “-3” is the softest level.

6. Push the menu switch “MENU”.

If the vehicle moves while you are adjusting the damping force, the information display will change to the display mode.

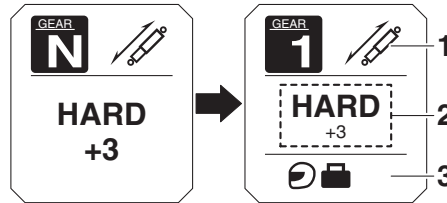

1. Damping force adjusting function

2. Damping force setting

3. Preload setting pictogram

EWA16421

⚠ WARNING

The rear shock absorber assembly contains highly pressurized nitrogen gas. Read and understand the following information before handling the shock absorber assembly.

- Do not tamper with or attempt to open the cylinder assembly.
- Do not subject the shock absorber assembly to an open flame or other high heat source. This may cause the unit to explode due to excessive gas pressure.

- Do not deform or damage the cylinder in any way. Cylinder damage will result in poor damping performance.
- Do not dispose of a damaged or worn-out shock absorber assembly yourself. Take the shock absorber assembly to a Yamaha dealer for any service.

Carriers

EAU49702

This motorcycle is equipped with a standard carrier, and with an additional carrier, located under the passenger seat. This additional carrier extends the loading surface and the loading capacity of the standard carrier.

To use the additional carrier, consult a Yamaha dealer.

Standard carrier

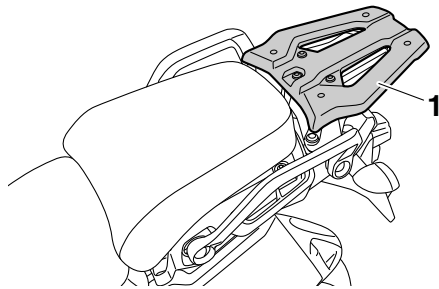

1. Standard carrier

Additional carrier

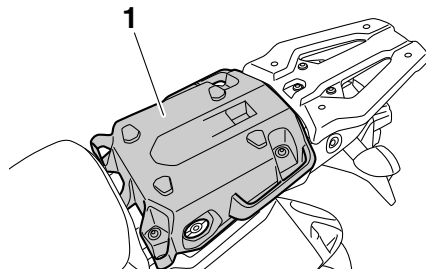

1. Additional carrier

EWA15482

! WARNING

- Do not exceed the maximum load of 205 kg (452 lb) for the vehicle.
- Do not sit on and never ride with a passenger on the standard or additional carrier.
- Do not exceed the standard carrier capacity of 5 kg (11 lb).
- Do not exceed the additional carrier capacity of 5 kg (11 lb).

ECA16822

NOTICE

Do not lift the vehicle by either carrier.

Luggage strap holders

EAU49491

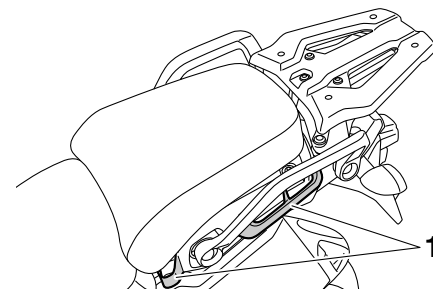

1. Luggage strap holder

There are four luggage strap holders below the passenger seat.

INSTRUMENT AND CONTROL FUNCTIONS

Sidestand

EAU15306

The sidestand is located on the left side of the frame. Raise the sidestand or lower it with your foot while holding the vehicle upright.

3

TIP

The built-in sidestand switch is part of the ignition circuit cut-off system, which cuts the ignition in certain situations. (See the following section for an explanation of the ignition circuit cut-off system.)

EWA10242

WARNING

The vehicle must not be ridden with the sidestand down, or if the sidestand cannot be properly moved up (or does not stay up), otherwise the sidestand could contact the ground and distract the operator, resulting in a possible loss of control. Yamaha's ignition circuit cut-off system has been designed to assist the operator in fulfilling the responsibility of raising the sidestand before starting off. Therefore, check

this system regularly and have a Yamaha dealer repair it if it does not function properly.

EAU54491

Ignition circuit cut-off system

The ignition circuit cut-off system (comprising the sidestand switch, clutch switch and neutral switch) has the following functions.

- It prevents starting when the transmission is in gear and the sidestand is up, but the clutch lever is not pulled.
- It prevents starting when the transmission is in gear and the clutch lever is pulled, but the sidestand is still down.
- It cuts the running engine when the transmission is in gear and the sidestand is moved down.

Periodically check the operation of the ignition circuit cut-off system according to the following procedure.

INSTRUMENT AND CONTROL FUNCTIONS

With the engine turned off:

1. Move the sidestand down.
2. Make sure that the start/engine stop switch is set to “○”.
3. Turn the key on.
4. Shift the transmission into the neutral position.
5. Push the “⊕” side of the start/engine stop switch.

Does the engine start?

YES

NO

With the engine still running:

6. Move the sidestand up.
7. Keep the clutch lever pulled.
8. Shift the transmission into gear.
9. Move the sidestand down.

Does the engine stall?

YES

NO

After the engine has stalled:

10. Move the sidestand up.
11. Keep the clutch lever pulled.
12. Push the “⊕” side of the start/engine stop switch.

Does the engine start?

YES

NO

The system is OK. **The motorcycle can be ridden.**

WARNING

- The vehicle must be placed on the centerstand during this inspection.
- If a malfunction is noted, have a Yamaha dealer check the system before riding.

The neutral switch may not be working correctly.
The motorcycle should not be ridden until checked by a Yamaha dealer.

The sidestand switch may not be working correctly.
The motorcycle should not be ridden until checked by a Yamaha dealer.

The clutch switch may not be working correctly.
The motorcycle should not be ridden until checked by a Yamaha dealer.

INSTRUMENT AND CONTROL FUNCTIONS

Auxiliary DC jack

EAU49453

EWA14361

WARNING

To prevent electrical shock or short-circuiting, make sure that the cap is installed when the auxiliary DC jack is not being used.

ECA15432

NOTICE

The accessory connected to the auxiliary DC jack should not be used with the engine turned off, and the load must never exceed 30 W (2.5 A), otherwise the fuse may blow or the battery may discharge.

This vehicle is equipped with an auxiliary DC jack.

A 12-V accessory connected to the auxiliary DC jack can be used when the key is in the “ON” position and should only be used when the engine is running.

To use the auxiliary DC jack

1. Turn the key to “OFF”.
2. Remove the auxiliary DC jack cap.

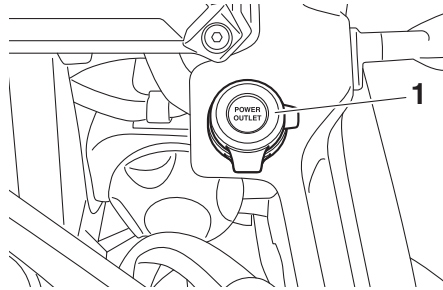

1. Auxiliary DC jack cap

3. Turn the accessory off.
4. Insert the accessory plug into the auxiliary DC jack.

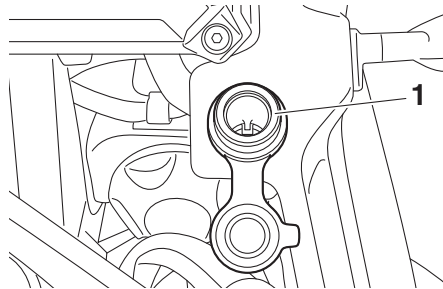

1. Auxiliary DC jack

5. Turn the key to “ON”, and then start the engine. (See page 5-1.)
6. Turn the accessory on.

FOR YOUR SAFETY – PRE-OPERATION CHECKS

EAU15598

Inspect your vehicle each time you use it to make sure the vehicle is in safe operating condition. Always follow the inspection and maintenance procedures and schedules described in the Owner's Manual.

EWA11152

WARNING

Failure to inspect or maintain the vehicle properly increases the possibility of an accident or equipment damage. Do not operate the vehicle if you find any problem. If a problem cannot be corrected by the procedures provided in this manual, have the vehicle inspected by a Yamaha dealer.

4

Before using this vehicle, check the following points:

ITEM	CHECKS	PAGE
Fuel	<ul style="list-style-type: none">• Check fuel level in fuel tank.• Refuel if necessary.• Check fuel line for leakage.• Check fuel tank breather hose and overflow hose for obstructions, cracks or damage, and check hose connections.	3-32, 3-33
Engine oil	<ul style="list-style-type: none">• Check oil level in engine.• If necessary, add recommended oil to specified level.• Check vehicle for oil leakage.	6-11
Final gear oil	<ul style="list-style-type: none">• Check vehicle for oil leakage.	6-14
Coolant	<ul style="list-style-type: none">• Check coolant level in reservoir.• If necessary, add recommended coolant to specified level.• Check cooling system for leakage.	6-15
Front brake	<ul style="list-style-type: none">• Check operation.• If soft or spongy, have Yamaha dealer bleed hydraulic system.• Check brake pads for wear.• Replace if necessary.• Check fluid level in reservoir.• If necessary, add specified brake fluid to specified level.• Check hydraulic system for leakage.	6-22, 6-23

FOR YOUR SAFETY – PRE-OPERATION CHECKS

ITEM	CHECKS	PAGE
Rear brake	<ul style="list-style-type: none"> • Check operation. • If soft or spongy, have Yamaha dealer bleed hydraulic system. • Check brake pads for wear. • Replace if necessary. • Check fluid level in reservoir. • If necessary, add specified brake fluid to specified level. • Check hydraulic system for leakage. 	6-22, 6-23
Clutch	<ul style="list-style-type: none"> • Check operation. • If soft or spongy, have Yamaha dealer bleed hydraulic system. • Check hydraulic system for leakage. 	6-21
Throttle grip	<ul style="list-style-type: none"> • Make sure that operation is smooth. • Check throttle grip free play. • If necessary, have Yamaha dealer adjust throttle grip free play and lubricate cable and grip housing. 	6-17, 6-24
Wheels and tires	<ul style="list-style-type: none"> • Check for damage. • Check tire condition and tread depth. • Check air pressure. • Correct if necessary. 	6-18, 6-20
Brake and shift pedals	<ul style="list-style-type: none"> • Make sure that operation is smooth. • Lubricate pedal pivoting points if necessary. 	6-25
Brake and clutch levers	<ul style="list-style-type: none"> • Make sure that operation is smooth. • Lubricate lever pivoting points if necessary. 	6-25
Centerstand, sidestand	<ul style="list-style-type: none"> • Make sure that operation is smooth. • Lubricate pivots if necessary. 	6-26
Chassis fasteners	<ul style="list-style-type: none"> • Make sure that all nuts, bolts and screws are properly tightened. • Tighten if necessary. 	—
Instruments, lights, signals and switches	<ul style="list-style-type: none"> • Check operation. • Correct if necessary. 	—
Sidestand switch	<ul style="list-style-type: none"> • Check operation of ignition circuit cut-off system. • If system is not working correctly, have Yamaha dealer check vehicle. 	3-43

OPERATION AND IMPORTANT RIDING POINTS

EAU15952

Read the Owner's Manual carefully to become familiar with all controls. If there is a control or function you do not understand, ask your Yamaha dealer.

EWA10272



Failure to familiarize yourself with the controls can lead to loss of control, which could cause an accident or injury.

EAU48712

TIP

This model is equipped with:

- a lean angle sensor to stop the engine in case of a turnover. In this case, the display will indicate error code 30, but this is not a malfunction. Turn the key to "OFF" and then to "ON" to clear the error code. Failing to do so will prevent the engine from starting even though the engine will crank when pushing the start switch.
- an engine auto-stop system. The engine stops automatically if left idling for 20 minutes. If the engine stops, simply push the start switch to restart the engine.

EAU58240

Starting the engine

In order for the ignition circuit cut-off system to enable starting, one of the following conditions must be met:

- The transmission is in the neutral position.
- The transmission is in gear with the clutch lever pulled and the sidestand up.

See page 3-43 for more information.

1. Turn the key to "ON" and make sure that the start/engine stop switch is set to "○".

The following warning lights and indicator lights should come on for a few seconds, then go off.

- Oil level warning light
- Engine trouble warning light
- Traction control system indicator/warning light
- Cruise control indicator lights
- Electronically adjustable suspension system warning light
- Immobilizer system indicator light

OPERATION AND IMPORTANT RIDING POINTS

ECA11834

NOTICE

If a warning or indicator light does not come on initially when the key is turned to “ON”, or if a warning or indicator light remains on, see page 3-4 for the corresponding warning and indicator light circuit check.

The ABS warning light should come on when the key is turned to “ON”, and then go off after traveling at a speed of 10 km/h (6 mi/h) or higher.

ECA17682

NOTICE

If the ABS warning light does not come on and then go off as explained above, see page 3-4 for the warning light circuit check.

2. Shift the transmission into the neutral position. The neutral indicator light should come on. If not, ask a Yamaha dealer to check the electrical circuit.
3. Start the engine by pushing the “(⊕)” side of the start/engine stop switch.

If the engine fails to start, release the start/engine stop switch, wait a few seconds, and then try again. Each starting attempt should be as short as possible to preserve the battery. Do not crank the engine more than 10 seconds on any one attempt.

ECA11043

NOTICE

For maximum engine life, never accelerate hard when the engine is cold!

EAU16673

Shifting

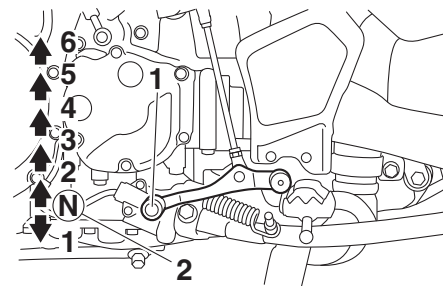

1. Shift pedal
2. Neutral position

Shifting gears lets you control the amount of engine power available for starting off, accelerating, climbing hills, etc.

The gear positions are shown in the illustration.

TIP

To shift the transmission into the neutral position, press the shift pedal down repeatedly until it reaches the end of its travel, and then slightly raise it.

NOTICE

ECA10261

- Even with the transmission in the neutral position, do not coast for long periods of time with the engine off, and do not tow the motorcycle for long distances. The transmission is properly lubricated only when the engine is running. Inadequate lubrication may damage the transmission.
- Always use the clutch while changing gears to avoid damaging the engine, transmission, and drive train, which are not designed to withstand the shock of forced shifting.

Tips for reducing fuel consumption

EAU16811

Fuel consumption depends largely on your riding style. Consider the following tips to reduce fuel consumption:

- Shift up swiftly, and avoid high engine speeds during acceleration.
- Do not rev the engine while shifting down, and avoid high engine speeds with no load on the engine.
- Turn the engine off instead of letting it idle for an extended length of time (e.g., in traffic jams, at traffic lights or at railroad crossings).

Engine break-in

EAU16842

There is never a more important period in the life of your engine than the period between 0 and 1600 km (1000 mi). For this reason, you should read the following material carefully.

Since the engine is brand new, do not put an excessive load on it for the first 1600 km (1000 mi). The various parts in the engine wear and polish themselves to the correct operating clearances. During this period, prolonged full-throttle operation or any condition that might result in engine overheating must be avoided.

5

EAU58990

0–1000 km (0–600 mi)

Avoid prolonged operation above 3900 r/min. **NOTICE: After 1000 km (600 mi) of operation, the engine oil and final gear oil must be changed, and the oil filter cartridge or element replaced.** [ECA10333]

OPERATION AND IMPORTANT RIDING POINTS

1000–1600 km (600–1000 mi)

Avoid prolonged operation above 4700 r/min.

1600 km (1000 mi) and beyond

The vehicle can now be operated normally.

ECA20190

NOTICE

- Keep the engine speed out of the tachometer high-rpm zone.
 - If any engine trouble should occur during the engine break-in period, immediately have a Yamaha dealer check the vehicle.
-

EAU17214

Parking

When parking, stop the engine, and then remove the key from the main switch.

EWA10312

WARNING

- Since the engine and exhaust system can become very hot, park in a place where pedestrians or children are not likely to touch them and be burned.
 - Do not park on a slope or on soft ground, otherwise the vehicle may overturn, increasing the risk of a fuel leak and fire.
 - Do not park near grass or other flammable materials which might catch fire.
-

PERIODIC MAINTENANCE AND ADJUSTMENT

EAU17245

EWA15123

EAU17303

Periodic inspection, adjustment, and lubrication will keep your vehicle in the safest and most efficient condition possible. Safety is an obligation of the vehicle owner/operator. The most important points of vehicle inspection, adjustment, and lubrication are explained on the following pages.

The intervals given in the periodic maintenance charts should be simply considered as a general guide under normal riding conditions. However, depending on the weather, terrain, geographical location, and individual use, the maintenance intervals may need to be shortened.

EWA10322

EWA15461

WARNING

Failure to properly maintain the vehicle or performing maintenance activities incorrectly may increase your risk of injury or death during service or while using the vehicle. If you are not familiar with vehicle service, have a Yamaha dealer perform service.

WARNING

Turn off the engine when performing maintenance unless otherwise specified.

- **A running engine has moving parts that can catch on body parts or clothing and electrical parts that can cause shocks or fires.**
- **Running the engine while servicing can lead to eye injury, burns, fire, or carbon monoxide poisoning – possibly leading to death. See page 1-2 for more information about carbon monoxide.**

WARNING

Brake discs, calipers, drums, and linings can become very hot during use. To avoid possible burns, let brake components cool before touching them.

Emission controls not only function to ensure cleaner air, but are also vital to proper engine operation and maximum performance. In the following periodic maintenance charts, the services related to emissions control are grouped separately. These services require specialized data, knowledge, and equipment. Maintenance, replacement, or repair of the emission control devices and systems may be performed by any repair establishment or individual that is certified (if applicable). Yamaha dealers are trained and equipped to perform these particular services.

PERIODIC MAINTENANCE AND ADJUSTMENT

EAU49563

Owner's tool kit

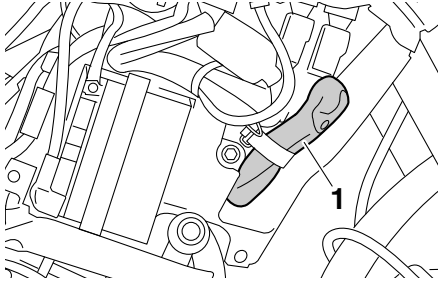

1. Owner's tool kit

6

The owner's tool kit is located behind cowling A. (See page 6-8.)

To access the owner's tool kit, remove cowling A with the hexagon wrench, located on the bottom of the rider seat. (See page 3-34.)

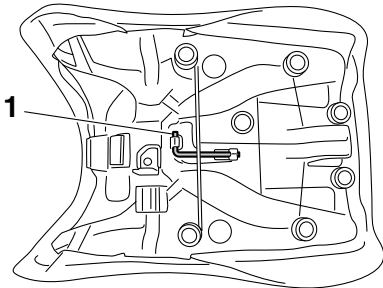

1. Hexagon wrench

The service information included in this manual and the tools provided in the owner's tool kit are intended to assist you in the performance of preventive maintenance and minor repairs. However, additional tools such as a torque wrench may be necessary to perform certain maintenance work correctly.

TIP

If you do not have the tools or experience required for a particular job, have a Yamaha dealer perform it for you.

PERIODIC MAINTENANCE AND ADJUSTMENT

EAU46862

TIP

- **The annual checks must be performed every year, except if a kilometer-based maintenance, or for the UK, a mileage-based maintenance, is performed instead.**
- From 50000 km (30000 mi), repeat the maintenance intervals starting from 10000 km (6000 mi).
- Items marked with an asterisk should be performed by a Yamaha dealer as they require special tools, data and technical skills.

Periodic maintenance chart for the emission control system

EAU46911

NO.	ITEM	CHECK OR MAINTENANCE JOB	ODOMETER READING					ANNUAL CHECK
			1000 km (600 mi)	10000 km (6000 mi)	20000 km (12000 mi)	30000 km (18000 mi)	40000 km (24000 mi)	
1	* Fuel line	<ul style="list-style-type: none"> • Check fuel hoses for cracks or damage. 		√	√	√	√	√
2	* Spark plugs	<ul style="list-style-type: none"> • Check condition. • Clean and regap. 		√		√		
		<ul style="list-style-type: none"> • Replace. 			√		√	
3	* Valves	<ul style="list-style-type: none"> • Check valve clearance. • Adjust. 	Every 40000 km (24000 mi)					
4	* Fuel injection system	<ul style="list-style-type: none"> • Adjust synchronization. 		√	√	√	√	√
5	* Muffler and exhaust pipe	<ul style="list-style-type: none"> • Check the screw clamp(s) for looseness. 	√	√	√	√	√	

PERIODIC MAINTENANCE AND ADJUSTMENT

EAU1770K

General maintenance and lubrication chart

NO.	ITEM	CHECK OR MAINTENANCE JOB	ODOMETER READING					ANNUAL CHECK
			1000 km (600 mi)	10000 km (6000 mi)	20000 km (12000 mi)	30000 km (18000 mi)	40000 km (24000 mi)	
1	* Air filter element	• Replace.					√	
2	* Clutch	• Check operation, fluid level and vehicle for fluid leakage.	√	√	√	√	√	
3	* Front brake	• Check operation, fluid level and vehicle for fluid leakage.	√	√	√	√	√	√
		• Replace brake pads.	Whenever worn to the limit					
4	* Rear brake	• Check operation, fluid level and vehicle for fluid leakage.	√	√	√	√	√	√
		• Replace brake pads.	Whenever worn to the limit					
5	* Brake hoses	• Check for cracks or damage. • Check for correct routing and clamping.		√	√	√	√	√
		• Replace.	Every 4 years					
6	* Brake fluid	• Replace.	Every 2 years					
7	* Wheels	• Check rim runout and spokes for damage. • Tighten all spokes.	At the initial 1000 km (600 mi) and every 5000 km (3000 mi) thereafter.					
8	* Tires	• Check tread depth and for damage. • Replace if necessary. • Check air pressure. • Correct if necessary.		√	√	√	√	√
9	* Wheel bearings	• Check bearings for looseness or damage.		√	√	√	√	

6

PERIODIC MAINTENANCE AND ADJUSTMENT

NO.	ITEM	CHECK OR MAINTENANCE JOB	ODOMETER READING					ANNUAL CHECK
			1000 km (600 mi)	10000 km (6000 mi)	20000 km (12000 mi)	30000 km (18000 mi)	40000 km (24000 mi)	
10	* Swingarm	• Check operation and for excessive play.		√	√	√	√	
		• Lubricate with lithium-soap-based grease.	Every 50000 km (30000 mi)					
11	* Steering bearings	• Check bearing play and steering for roughness.	√	√	√	√	√	
		• Lubricate with lithium-soap-based grease.	Every 50000 km (30000 mi)					
12	* Chassis fasteners	• Make sure that all nuts, bolts and screws are properly tightened.		√	√	√	√	√
13	Brake lever pivot shaft	• Lubricate with silicone grease.		√	√	√	√	√
14	Brake pedal pivot shaft	• Lubricate with lithium-soap-based grease.		√	√	√	√	√
15	Clutch lever pivot shaft	• Lubricate with silicone grease.		√	√	√	√	√
16	Shift pedal pivot shaft	• Lubricate with lithium-soap-based grease.		√	√	√	√	√
17	Sidestand, center-stand	• Check operation. • Lubricate with lithium-soap-based grease.		√	√	√	√	√
18	* Sidestand switch	• Check operation.	√	√	√	√	√	√
19	* Front fork	• Check operation and for oil leakage.		√	√	√	√	
20	* Shock absorber assembly	• Check operation and shock absorber for oil leakage.		√	√	√	√	

PERIODIC MAINTENANCE AND ADJUSTMENT

NO.	ITEM	CHECK OR MAINTENANCE JOB	ODOMETER READING					ANNUAL CHECK
			1000 km (600 mi)	10000 km (6000 mi)	20000 km (12000 mi)	30000 km (18000 mi)	40000 km (24000 mi)	
21 *	Rear suspension relay arm and connecting arm pivoting points	<ul style="list-style-type: none"> • Check operation. 		√	√	√	√	
22	Engine oil	<ul style="list-style-type: none"> • Change. • Check oil level and vehicle for oil leakage. 	√	√	√	√	√	√
23	Engine oil filter cartridge	<ul style="list-style-type: none"> • Replace. 	√		√		√	
24 *	Cooling system	<ul style="list-style-type: none"> • Check coolant level and vehicle for coolant leakage. 		√	√	√	√	√
		<ul style="list-style-type: none"> • Change coolant. 	Every 3 years					
25	Final gear oil	<ul style="list-style-type: none"> • Check oil level and vehicle for oil leakage. 	√	√		√		
		<ul style="list-style-type: none"> • Change. 	√		√		√	
26 *	Front and rear brake switches	<ul style="list-style-type: none"> • Check operation. 	√	√	√	√	√	√
27	Moving parts and cables	<ul style="list-style-type: none"> • Lubricate. 		√	√	√	√	√
28 *	Throttle grip	<ul style="list-style-type: none"> • Check operation. • Check throttle grip free play, and adjust if necessary. • Lubricate cable and grip housing. • Lubricate grip warmer wire and wire housing. 		√	√	√	√	√
29 *	Lights, signals and switches	<ul style="list-style-type: none"> • Check operation. • Adjust headlight beam. 	√	√	√	√	√	√

PERIODIC MAINTENANCE AND ADJUSTMENT

EAU36773

TIP

- Air filter
 - This model's air filter is equipped with a disposable oil-coated paper element, which must not be cleaned with compressed air to avoid damaging it.
 - The air filter element needs to be replaced more frequently when riding in unusually wet or dusty areas.
 - Hydraulic brake and clutch service
 - Regularly check and, if necessary, correct the brake fluid and clutch fluid levels.
 - Every two years replace the internal components of the brake master cylinders and calipers as well as clutch master and release cylinders, and change the brake and clutch fluids.
 - Replace the brake and clutch hoses every four years and if cracked or damaged.
-

PERIODIC MAINTENANCE AND ADJUSTMENT

Removing and installing cowlings

EAU18782

The cowlings shown need to be removed to perform some of the maintenance jobs described in this chapter. Refer to this section each time a cowling needs to be removed and installed.

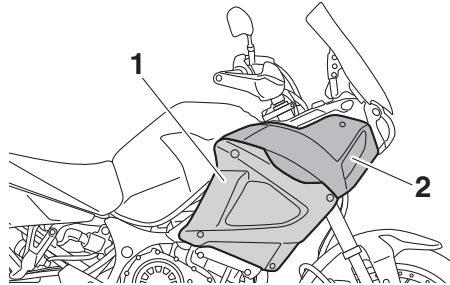

1. Cowling A
2. Cowling B

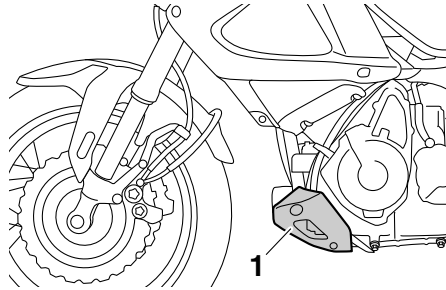

1. Cowling C

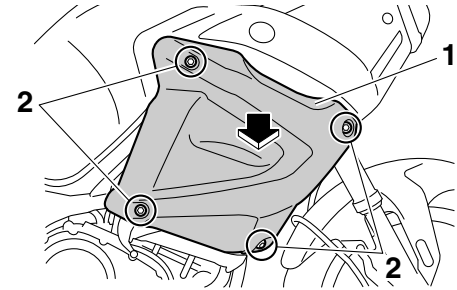

1. Cowling A
2. Quick fastener screw

EAU55960

To install the cowling

1. Fit the projections on the cowling into the matching holes in cowling B.

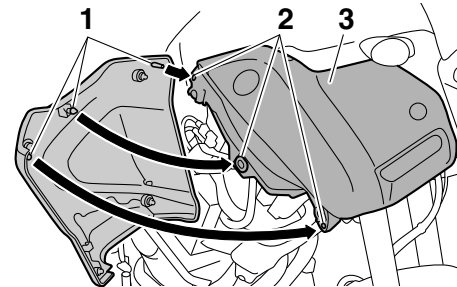

1. Projection
2. Matching hole
3. Cowling B

PERIODIC MAINTENANCE AND ADJUSTMENT

2. Install the quick fastener screws.

Cowling B

To remove the cowling

1. Remove cowling A.
2. Remove the bolts and the quick fasteners, and then pull the cowling off.

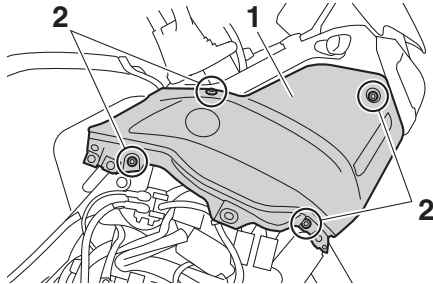

1. Cowling B
2. Bolt

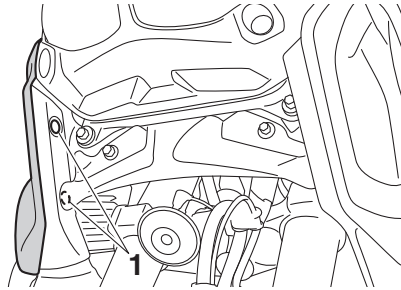

1. Quick fastener

To install the cowling

1. Place the cowling in the original position, and then install the bolts and the quick fasteners.
2. Install cowling A.

Cowling C

To remove the cowling

Remove the bolts and the nuts, and then take the cowling off.

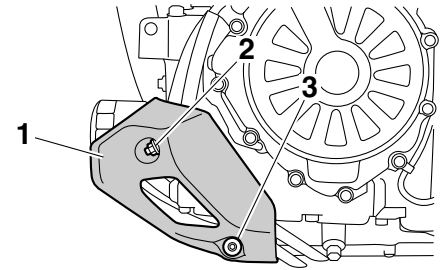

1. Cowling C
2. Nut
3. Bolt

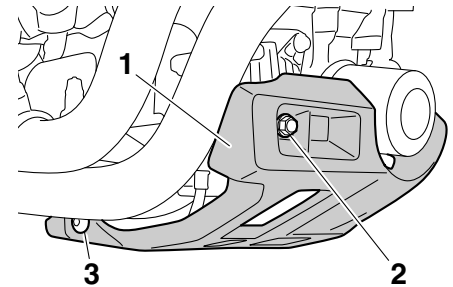

1. Cowling C
2. Nut
3. Bolt

PERIODIC MAINTENANCE AND ADJUSTMENT

To install the cowling

Place the cowling in the original position, and then install the bolts and the nuts.

Checking the spark plugs

EAU19653

The spark plugs are important engine components, which should be checked periodically, preferably by a Yamaha dealer. Since heat and deposits will cause any spark plug to slowly erode, they should be removed and checked in accordance with the periodic maintenance and lubrication chart. In addition, the condition of the spark plugs can reveal the condition of the engine.

The porcelain insulator around the center electrode of each spark plug should be a medium-to-light tan (the ideal color when the vehicle is ridden normally), and all spark plugs installed in the engine should have the same color. If any spark plug shows a distinctly different color, the engine could be operating improperly. Do not attempt to diagnose such problems yourself. Instead, have a Yamaha dealer check the vehicle.

If a spark plug shows signs of electrode erosion and excessive carbon or other deposits, it should be replaced.

Specified spark plug:
NGK/CPR8EB9

Before installing a spark plug, the spark plug gap should be measured with a wire thickness gauge and, if necessary, adjusted to specification.

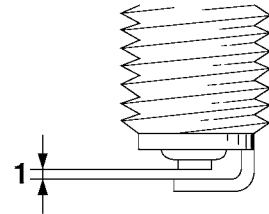

1. Spark plug gap

Spark plug gap:
0.8–0.9 mm (0.031–0.035 in)

Clean the surface of the spark plug gasket and its mating surface, and then wipe off any grime from the spark plug threads.

Tightening torque:
Spark plug:
13 Nm (1.3 m·kgf, 9.4 ft·lbf)

PERIODIC MAINTENANCE AND ADJUSTMENT

TIP _____

If a torque wrench is not available when installing a spark plug, a good estimate of the correct torque is 1/4–1/2 turn past finger tight. However, the spark plug should be tightened to the specified torque as soon as possible.

ECA10841

NOTICE _____

Do not use any tools to remove or install the spark plug cap, otherwise the ignition coil coupler may get damaged. The spark plug cap may be difficult to remove because the rubber seal on the end of the cap fits tightly. To remove the spark plug cap, simply twist it back and forth while pulling it out; to install it, twist it back and forth while pushing it in.

Engine oil and oil filter cartridge

EAU49504

The engine oil level should be checked before each ride. In addition, the oil must be changed and the oil filter cartridge replaced at the intervals specified in the periodic maintenance and lubrication chart.

To check the engine oil level

1. Place the vehicle on the centerstand. A slight tilt to the side can result in a false reading.
2. Start the engine and warm it up for ten minutes until the engine oil has reached a normal temperature of 60 °C (140 °F), and then turn the engine off.
3. Wait a few minutes until the oil settles, and then check the oil level through the engine oil level check window located at the bottom-right side of the crankcase.

TIP _____

The engine oil should be between the minimum and maximum level marks.

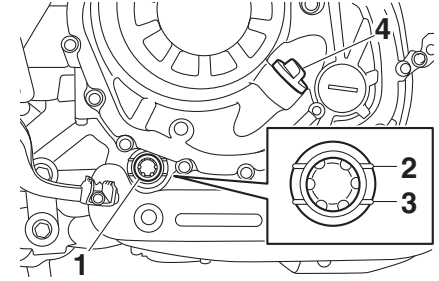

1. Engine oil level check window
2. Maximum level mark
3. Minimum level mark
4. Engine oil filler cap

4. If the engine oil is below the minimum level mark, add sufficient oil of the recommended type to raise it to the correct level.

To change the engine oil (with or without oil filter cartridge replacement)

1. Place the vehicle on a level surface.
2. Start the engine, warm it up for several minutes, and then turn it off.
3. Place an oil pan under the oil tank to collect the used oil.

PERIODIC MAINTENANCE AND ADJUSTMENT

4. Remove the engine oil filler cap, the drain bolt and its gasket to drain the oil from the oil tank.

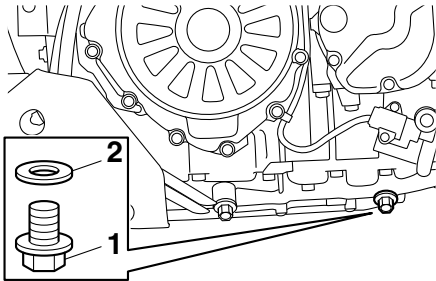

1. Engine oil drain bolt (oil tank)
2. Gasket

5. Place an oil pan under the engine to collect the used oil.
6. Remove the engine oil drain bolt and its gasket to drain the oil from the crankcase.

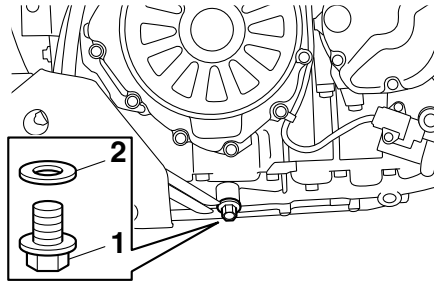

1. Engine oil drain bolt (crankcase)
2. Gasket

TIP

Skip steps 7–11 if the oil filter cartridge is not being replaced.

7. Remove cowling C. (See page 6-8.)
8. Remove the oil filter cartridge with an oil filter wrench.

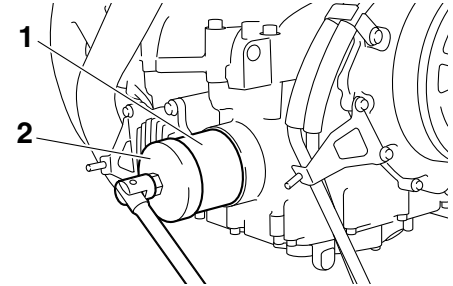

1. Oil filter cartridge
2. Oil filter wrench

TIP

An oil filter wrench is available at a Yamaha dealer.

9. Apply a thin coat of clean engine oil to the O-ring of the new oil filter cartridge.

PERIODIC MAINTENANCE AND ADJUSTMENT

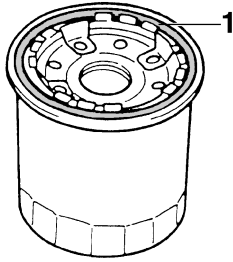

1. O-ring

TIP

Make sure that the O-ring is properly seated.

10. Install the new oil filter cartridge with an oil filter wrench, and then tighten it to the specified torque with a torque wrench.

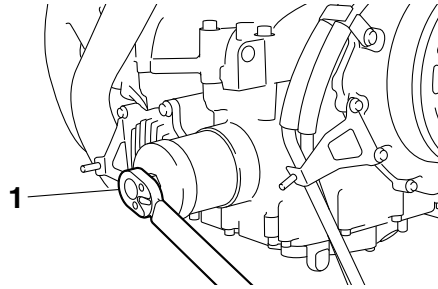

1. Torque wrench

Tightening torque:

Oil filter cartridge:
17 Nm (1.7 m·kgf, 12 ft·lbf)

11. Install the cowlings.
12. Install the engine oil drain bolts and their new gasket, and then tighten the bolts to the specified torques.

Tightening torques:

Engine oil drain bolt (crankcase):
20 Nm (2.0 m·kgf, 14 ft·lbf)
Engine oil drain bolt (oil tank):
20 Nm (2.0 m·kgf, 14 ft·lbf)

13. Refill with the specified amount of the recommended engine oil, and then install and tighten the oil filler cap.

Recommended engine oil:

See page 8-1.

Oil quantity:

Without oil filter cartridge replacement:

3.10 L (3.28 US qt, 2.73 Imp.qt)

With oil filter cartridge replacement:

3.40 L (3.59 US qt, 2.99 Imp.qt)

TIP

Be sure to wipe off spilled oil on any parts after the engine and exhaust system have cooled down.

ECA11621

NOTICE

- In order to prevent clutch slippage (since the engine oil also lubricates the clutch), do not mix any chemical additives. Do not use oils with a diesel specification of "CD" or oils of a higher quality than specified. In

PERIODIC MAINTENANCE AND ADJUSTMENT

addition, do not use oils labeled “ENERGY CONSERVING II” or higher.

- **Make sure that no foreign material enters the crankcase.**

14. Start the engine, and then let it idle for several minutes while checking it for oil leakage. If oil is leaking, immediately turn the engine off and check for the cause.

TIP

After the engine is started, the engine oil level warning light should go off if the oil level is sufficient.

ECA10402

NOTICE

If the oil level warning light flickers or remains on even if the oil level is correct, immediately turn the engine off and have a Yamaha dealer check the vehicle.

15. Turn the engine off, wait a few minutes until the oil settles, and then check the oil level and correct it if necessary.

Final gear oil

EAU20017

The final gear case must be checked for oil leakage before each ride. If any leakage is found, have a Yamaha dealer check and repair the vehicle. In addition, the final gear oil level must be checked and the oil changed as follows at the intervals specified in the periodic maintenance and lubrication chart.

EWA10371

WARNING

- **Make sure that no foreign material enters the final gear case.**
- **Make sure that no oil gets on the tire or wheel.**

To check the final gear oil level

1. Place the vehicle on the center-stand.

TIP

Make sure that the vehicle is positioned straight up when checking the oil level. A slight tilt to the side can result in a false reading.

2. Remove the final gear oil filler bolt and its gasket, and then check the oil level in the final gear case.

TIP

The oil level should be at the brim of the filler hole.

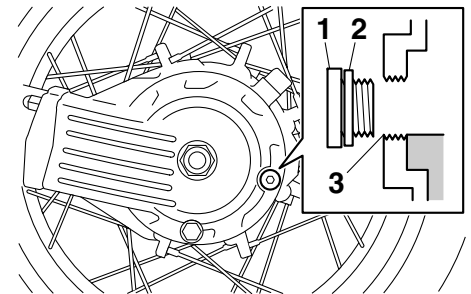

1. Final gear oil filler bolt
2. Gasket
3. Correct oil level

3. If the oil is below the brim of the filler hole, add sufficient oil of the recommended type to raise it to the correct level.
4. Check the gasket for damage, and replace it if necessary.
5. Install the final gear oil filler bolt and its gasket, and then tighten the bolt to the specified torque.

PERIODIC MAINTENANCE AND ADJUSTMENT

EAU20071

Tightening torque:

Final gear oil filler bolt:
23 Nm (2.3 m·kgf, 17 ft·lbf)

Tightening torque:

Final gear oil drain bolt:
23 Nm (2.3 m·kgf, 17 ft·lbf)

Coolant

The coolant level should be checked before each ride. In addition, the coolant must be changed at the intervals specified in the periodic maintenance and lubrication chart.

To change the final gear oil

1. Place the vehicle on a level surface.
2. Place an oil pan under the final gear case to collect the used oil.
3. Remove the final gear oil filler bolt, the final gear oil drain bolt and their gasket to drain the oil from the final gear case.

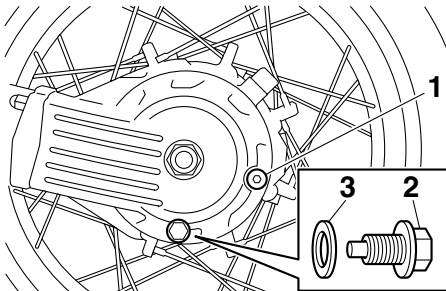

1. Final gear oil filler bolt
2. Final gear oil drain bolt
3. Gasket

4. Install the final gear oil drain bolt and its new gasket, and then tighten the bolt to the specified torque.

5. Refill with the recommended final gear oil to the brim of the filler hole.

Recommended final gear oil:

Yamaha genuine shaft drive gear oil
SAE 80W-90 API GL-5 or SAE 80
API GL-4 Hypoid gear oil

Oil quantity:

0.20 L (0.21 US qt, 0.18 Imp.qt)

6. Check the oil filler bolt gasket for damage, and replace it if necessary.
7. Install the oil filler bolt and its gasket, and then tighten the bolt to the specified torque.

Tightening torque:

Final gear oil filler bolt:
23 Nm (2.3 m·kgf, 17 ft·lbf)

8. Check the final gear case for oil leakage. If oil is leaking, check for the cause.

EAU40157

To check the coolant level

1. Place the vehicle on the centerstand.

TIP

- The coolant level must be checked on a cold engine since the level varies with engine temperature.
- Make sure that the vehicle is positioned straight up when checking the coolant level. A slight tilt to the side can result in a false reading.

2. Check the coolant level in the coolant reservoir.

TIP

The coolant should be between the minimum and maximum level marks.

PERIODIC MAINTENANCE AND ADJUSTMENT

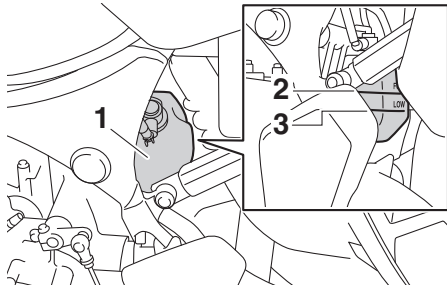

1. Coolant reservoir
2. Maximum level mark
3. Minimum level mark

3. If the coolant is at or below the minimum level mark, remove the coolant reservoir cap. **WARNING! Remove only the coolant reservoir cap. Never attempt to remove the radiator cap when the engine is hot.** [EWA15162]

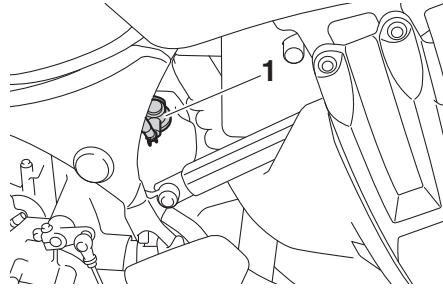

1. Coolant reservoir cap

4. Add coolant or distilled water to raise the coolant to the maximum level mark, install the coolant reservoir cap. **NOTICE: If coolant is not available, use distilled water or soft tap water instead. Do not use hard water or salt water since it is harmful to the engine. If water has been used instead of coolant, replace it with coolant as soon as possible, otherwise the cooling system will not be protected against frost and corrosion. If water has been added to the coolant, have a Yamaha dealer check the anti-freeze content of the coolant as**

soon as possible, otherwise the effectiveness of the coolant will be reduced. [ECA10473]

Coolant reservoir capacity (up to the maximum level mark):
0.26 L (0.27 US qt, 0.23 Imp.qt)

EAU33032

Changing the coolant

The coolant must be changed at the intervals specified in the periodic maintenance and lubrication chart. Have a Yamaha dealer change the coolant. **WARNING! Never attempt to remove the radiator cap when the engine is hot.** [EWA10382]

PERIODIC MAINTENANCE AND ADJUSTMENT

Air filter element

EAU36765

The air filter element must be replaced at the intervals specified in the periodic maintenance and lubrication chart. Have a Yamaha dealer replace the air filter element.

Checking the engine idling speed

EAU44735

Check the engine idling speed and, if necessary, have it corrected by a Yamaha dealer.

Engine idling speed:
1050–1150 r/min

Checking the throttle grip free play

EAU21385

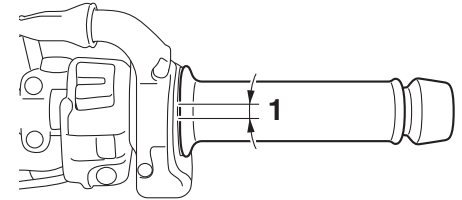

1. Throttle grip free play

The throttle grip free play should measure 3.0–5.0 mm (0.12–0.20 in) at the inner edge of the throttle grip. Periodically check the throttle grip free play and, if necessary, have a Yamaha dealer adjust it.

6

PERIODIC MAINTENANCE AND ADJUSTMENT

EAU21402

Valve clearance

The valve clearance changes with use, resulting in improper air-fuel mixture and/or engine noise. To prevent this from occurring, the valve clearance must be adjusted by a Yamaha dealer at the intervals specified in the periodic maintenance and lubrication chart.

EAU59162

Tires

Tires are the only contact between the vehicle and the road. Safety in all conditions of riding depends on a relatively small area of road contact. Therefore, it is essential to maintain the tires in good condition at all times and replace them at the appropriate time with the specified tires.

Tire air pressure

The tire air pressure should be checked and, if necessary, adjusted before each ride.

EWA10504



Operation of this vehicle with improper tire pressure may cause severe injury or death from loss of control.

- The tire air pressure must be checked and adjusted on cold tires (i.e., when the temperature of the tires equals the ambient temperature).
- The tire air pressure must be adjusted in accordance with the riding speed and with the total

weight of rider, passenger, cargo, and accessories approved for this model.

Tire air pressure (measured on cold tires):

Up to 90 kg (198 lb) load:

Front:

225 kPa (2.25 kgf/cm², 33 psi)

Rear:

250 kPa (2.50 kgf/cm², 36 psi)

90 kg (198 lb) to maximum load:

Front:

225 kPa (2.25 kgf/cm², 33 psi)

Rear:

290 kPa (2.90 kgf/cm², 42 psi)

Maximum load*:

205 kg (452 lb)

* Total weight of rider, passenger, cargo and accessories

EWA10512



Never overload your vehicle. Operation of an overloaded vehicle could cause an accident.

PERIODIC MAINTENANCE AND ADJUSTMENT

Tire inspection

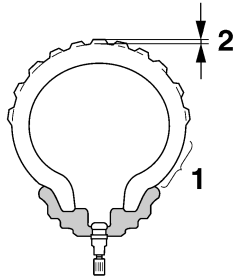

1. Tire sidewall
2. Tire tread depth

The tires must be checked before each ride. If the center tread depth reaches the specified limit, if the tire has a nail or glass fragments in it, or if the sidewall is cracked, have a Yamaha dealer replace the tire immediately.

Minimum tire tread depth (front and rear):
1.6 mm (0.06 in)

TIP

The tire tread depth limits may differ from country to country. Always comply with the local regulations.

⚠ WARNING

EWA10472

- Have a Yamaha dealer replace excessively worn tires. Besides being illegal, operating the vehicle with excessively worn tires decreases riding stability and can lead to loss of control.
- The replacement of all wheel and brake-related parts, including the tires, should be left to a Yamaha dealer, who has the necessary professional knowledge and experience to do so.
- Ride at moderate speeds after changing a tire since the tire surface must first be “broken in” for it to develop its optimal characteristics.

Tire information

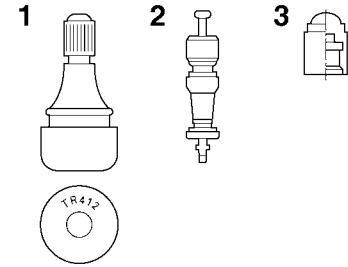

1. Tire air valve
2. Tire air valve core
3. Tire air valve cap with seal

This model is equipped with tubeless tires and tire air valves. Tires age, even if they have not been used or have only been used occasionally. Cracking of the tread and sidewall rubber, sometimes accompanied by carcass deformation, is an evidence of ageing. Old and aged tires shall be checked by tire specialists to ascertain their suitability for further use.

EWA10902

⚠ WARNING

- The front and rear tires should be of the same make and design, otherwise the handling

PERIODIC MAINTENANCE AND ADJUSTMENT

characteristics of the motorcycle may be different, which could lead to an accident.

- Always make sure that the valve caps are securely installed to prevent air pressure leakage.
- Use only the tire valves and valve cores listed below to avoid tire deflation during a ride.

After extensive tests, only the tires listed below have been approved for this model by Yamaha.

Front tire:

Size:

110/80R19M/C 59V

Manufacturer/model:

BRIDGESTONE/BW501

Rear tire:

Size:

150/70R17M/C 69V

Manufacturer/model:

BRIDGESTONE/BW502

FRONT and REAR:

Tire air valve:

TR412

Valve core:

#9100 (original)

EWA10601



This motorcycle is fitted with super-high-speed tires. Note the following points in order to make the most efficient use of these tires.

- Use only the specified replacement tires. Other tires may run the danger of bursting at super high speeds.
- Brand-new tires can have a relatively poor grip on certain road surfaces until they have been “broken in”. Therefore, it is advisable before doing any high-speed riding to ride conservatively for approximately 100 km (60 mi) after installing a new tire.
- The tires must be warmed up before a high-speed run.
- Always adjust the tire air pressure according to the operating conditions.

EAU49712

Spoke wheels

To maximize the performance, durability, and safe operation of your vehicle, note the following points regarding the specified wheels.

- The wheel rims should be checked for cracks, bends, warp-age or other damage, and the spokes for looseness or damage before each ride. If any damage is found, have a Yamaha dealer replace the wheel. Do not attempt even the smallest repair to the wheel. A deformed or cracked wheel must be replaced.
- The wheel should be balanced whenever either the tire or wheel has been changed or replaced. An unbalanced wheel can result in poor performance, adverse handling characteristics, and a shortened tire life.

PERIODIC MAINTENANCE AND ADJUSTMENT

Clutch lever

EAU42851

Since this model is equipped with a hydraulic clutch, adjusting the clutch lever free play is not needed. However, it is necessary to check the hydraulic system for leakage before each ride. If the clutch lever free play does become excessive, and shifting becomes rough or clutch slippage occurs, causing poor acceleration, there may be air in the clutch system. If there is air in the hydraulic system, have a Yamaha dealer bleed the system before operating the motorcycle.

Checking the brake lever free play

EAU37914

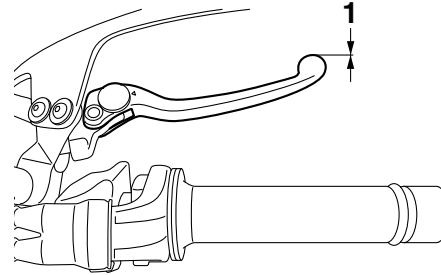

1. No brake lever free play

There should be no free play at the brake lever end. If there is free play, have a Yamaha dealer inspect the brake system.

EWA14212

WARNING

A soft or spongy feeling in the brake lever can indicate the presence of air in the hydraulic system. If there is air in the hydraulic system, have a Yamaha dealer bleed the system before operating the vehicle. Air in the hydraulic system will diminish the

braking performance, which may result in loss of control and an accident.

PERIODIC MAINTENANCE AND ADJUSTMENT

Brake light switches

EAU22283

The brake light, which is activated by the brake pedal and brake lever, should come on just before braking takes effect. Since the brake light switches are components of the cruise control system, they must be adjusted by a Yamaha dealer, who has the necessary professional knowledge and experience.

Checking the front and rear brake pads

EAU22393

The front and rear brake pads must be checked for wear at the intervals specified in the periodic maintenance and lubrication chart.

Front brake pads

EAU36891

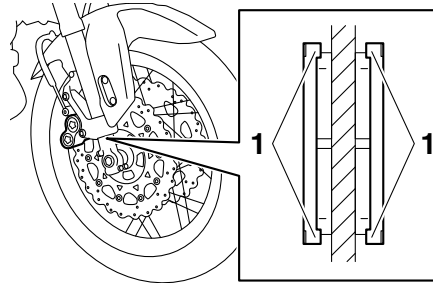

1. Brake pad wear indicator

Each front brake pad is provided with wear indicators, which allows you to check the brake pad wear without having to disassemble the brake. To check the brake pad wear, check the position of the wear indicators while applying the brake. If a brake pad has worn to the point that a wear indicator almost

touches the brake disc, have a Yamaha dealer replace the brake pads as a set.

Rear brake pads

EAU22501

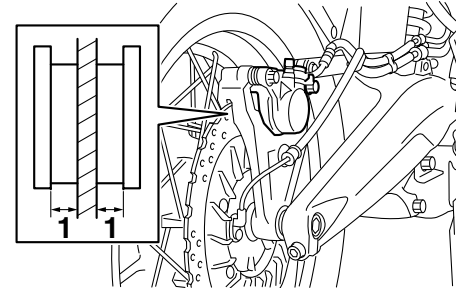

1. Lining thickness

Check each rear brake pad for damage and measure the lining thickness. If a brake pad is damaged or if the lining thickness is less than 0.8 mm (0.03 in), have a Yamaha dealer replace the brake pads as a set.

PERIODIC MAINTENANCE AND ADJUSTMENT

Checking the brake fluid level EAU40262

Before riding, check that the brake fluid is above the minimum level mark. Check the brake fluid level with the top of the reservoir level. Replenish the brake fluid if necessary.

Front brake

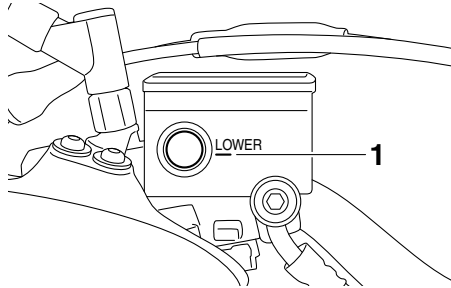

1. Minimum level mark

Rear brake

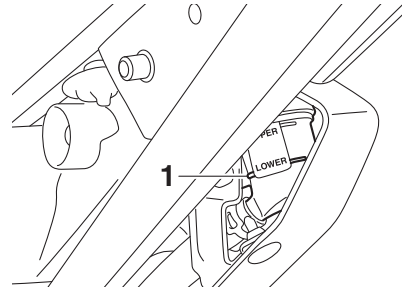

1. Minimum level mark

Specified brake fluid:
DOT 4

EWA16011

! WARNING

Improper maintenance can result in loss of braking ability. Observe these precautions:

- **Insufficient brake fluid may allow air to enter the brake system, reducing braking performance.**
- **Clean the filler cap before removing. Use only DOT 4 brake fluid from a sealed container.**

- **Use only the specified brake fluid; otherwise, the rubber seals may deteriorate, causing leakage.**
- **Refill with the same type of brake fluid. Adding a brake fluid other than DOT 4 may result in a harmful chemical reaction.**
- **Be careful that water or dust does not enter the brake fluid reservoir when refilling. Water will significantly lower the boiling point of the fluid and may result in vapor lock, and dirt may clog the ABS hydraulic unit valves.**

ECA17641

NOTICE

Brake fluid may damage painted surfaces or plastic parts. Always clean up spilled fluid immediately.

As the brake pads wear, it is normal for the brake fluid level to gradually go down. A low brake fluid level may indicate worn brake pads and/or brake system leakage; therefore, be sure to check the brake pads for wear and the brake system for leakage. If the brake

PERIODIC MAINTENANCE AND ADJUSTMENT

fluid level goes down suddenly, have a Yamaha dealer check the cause before further riding.

Changing the brake and clutch fluids

EAU22754

Have a Yamaha dealer change the brake and clutch fluids at the intervals specified in the periodic maintenance and lubrication chart. In addition, have the oil seals of the brake and clutch master cylinders and calipers as well as the brake and clutch hoses replaced at the intervals listed below or whenever they are damaged or leaking.

- Oil seals: Replace every two years.
- Brake and clutch hoses: Replace every four years.

Checking and lubricating the throttle grip and cable

EAU23115

The operation of the throttle grip should be checked before each ride. In addition, the cable should be lubricated by a Yamaha dealer at the intervals specified in the periodic maintenance chart.

The throttle cable is equipped with a rubber cover. Make sure that the cover is securely installed. Even though the cover is installed correctly, it does not completely protect the cable from water entry. Therefore, use care not to pour water directly onto the cover or cable when washing the vehicle. If the cable or cover becomes dirty, wipe clean with a moist cloth.

PERIODIC MAINTENANCE AND ADJUSTMENT

Checking and lubricating the brake and shift pedals EAU44275

The operation of the brake and shift pedals should be checked before each ride, and the pedal pivots should be lubricated if necessary.

Brake pedal

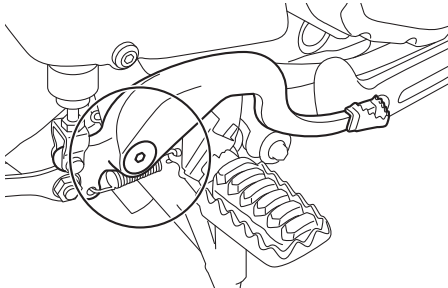

Shift pedal

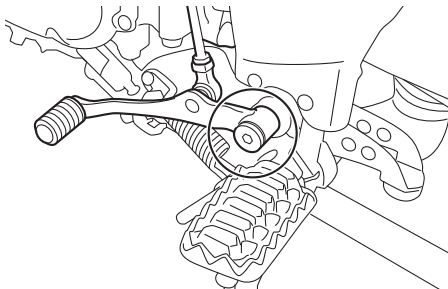

Recommended lubricant:
Lithium-soap-based grease

Checking and lubricating the brake and clutch levers EAU43602

The operation of the brake and clutch levers should be checked before each ride, and the lever pivots should be lubricated if necessary.

Brake lever

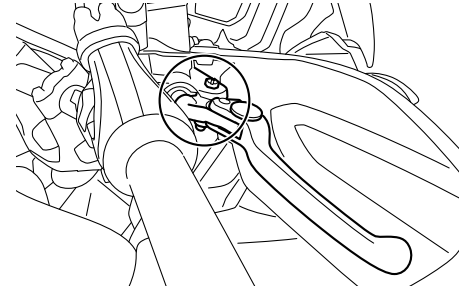

Clutch lever

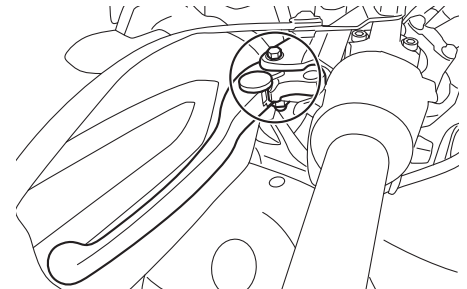

PERIODIC MAINTENANCE AND ADJUSTMENT

Recommended lubricant:
Silicone grease

Checking and lubricating the centerstand and sidestand

EAU23215

Recommended lubricant:
Lithium-soap-based grease

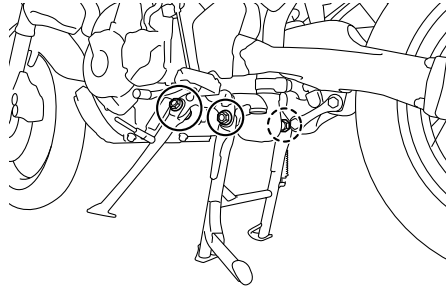

The operation of the centerstand and sidestand should be checked before each ride, and the pivots and metal-to-metal contact surfaces should be lubricated if necessary.

EWA10742

WARNING

If the centerstand or sidestand does not move up and down smoothly, have a Yamaha dealer check or repair it. Otherwise, the centerstand or sidestand could contact the ground and distract the operator, resulting in a possible loss of control.

PERIODIC MAINTENANCE AND ADJUSTMENT

Lubricating the swingarm pivots

EAUM1653

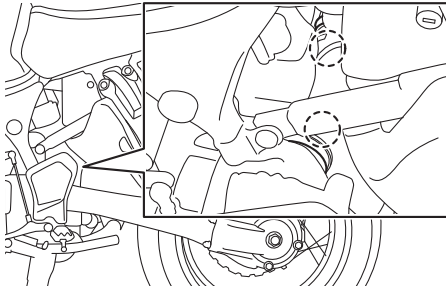

The swingarm pivots must be lubricated by a Yamaha dealer at the intervals specified in the periodic maintenance and lubrication chart.

Recommended lubricant:
Lithium-soap-based grease

Checking the front fork

EAU23273

The condition and operation of the front fork must be checked as follows at the intervals specified in the periodic maintenance and lubrication chart.

To check the condition

Check the inner tubes for scratches, damage and excessive oil leakage.

To check the operation

1. Place the vehicle on a level surface and hold it in an upright position. **WARNING! To avoid injury, securely support the vehicle so there is no danger of it falling over.** [EWA10752]
2. While applying the front brake, push down hard on the handlebars several times to check if the front fork compresses and rebounds smoothly.

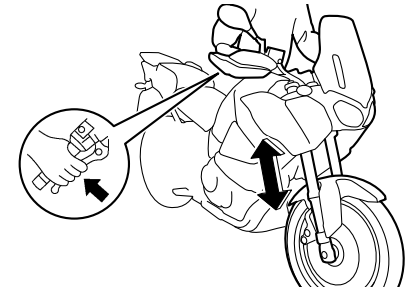

ECA10591

NOTICE

If any damage is found or the front fork does not operate smoothly, have a Yamaha dealer check or repair it.

PERIODIC MAINTENANCE AND ADJUSTMENT

EAU45512

Checking the steering

Worn or loose steering bearings may cause danger. Therefore, the operation of the steering must be checked as follows at the intervals specified in the periodic maintenance and lubrication chart.

1. Place the vehicle on the center-stand. **WARNING! To avoid injury, securely support the vehicle so there is no danger of it falling over.** [EWA10752]
2. Hold the lower ends of the front fork legs and try to move them forward and backward. If any free play can be felt, have a Yamaha dealer check or repair the steering.

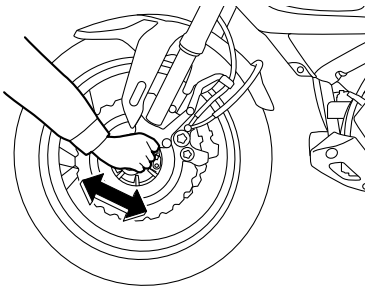

EAU23292

Checking the wheel bearings

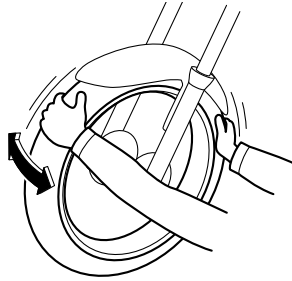

The front and rear wheel bearings must be checked at the intervals specified in the periodic maintenance and lubrication chart. If there is play in the wheel hub or if the wheel does not turn smoothly, have a Yamaha dealer check the wheel bearings.

EAU34226

Battery

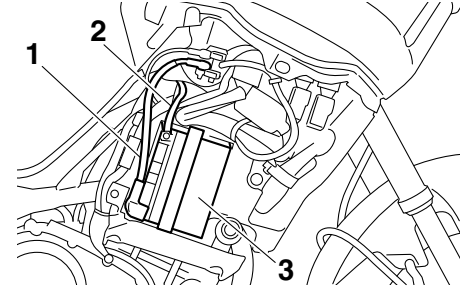

1. Positive battery lead (red)
2. Negative battery lead (black)
3. Battery

The battery is located behind cowling A. (See page 6-8.)

This model is equipped with a VRLA (Valve Regulated Lead Acid) battery. There is no need to check the electrolyte or to add distilled water. However, the battery lead connections need to be checked and, if necessary, tightened.

EWA10761

WARNING

- **Electrolyte is poisonous and dangerous since it contains sulfuric acid, which causes severe**

PERIODIC MAINTENANCE AND ADJUSTMENT

burns. Avoid any contact with skin, eyes or clothing and always shield your eyes when working near batteries. In case of contact, administer the following FIRST AID.

- **EXTERNAL:** Flush with plenty of water.
- **INTERNAL:** Drink large quantities of water or milk and immediately call a physician.
- **EYES:** Flush with water for 15 minutes and seek prompt medical attention.
- **Batteries produce explosive hydrogen gas. Therefore, keep sparks, flames, cigarettes, etc., away from the battery and provide sufficient ventilation when charging it in an enclosed space.**
- **KEEP THIS AND ALL BATTERIES OUT OF THE REACH OF CHILDREN.**

To charge the battery

Have a Yamaha dealer charge the battery as soon as possible if it seems to have discharged. Keep in mind that the

battery tends to discharge more quickly if the vehicle is equipped with optional electrical accessories.

ECA16522

NOTICE

To charge a VRLA (Valve Regulated Lead Acid) battery, a special (constant-voltage) battery charger is required. Using a conventional battery charger will damage the battery.

To store the battery

1. If the vehicle will not be used for more than one month, remove the battery, fully charge it, and then place it in a cool, dry place. **NOTICE: When removing the battery, be sure the key is turned to “OFF”, then disconnect the negative lead before disconnecting the positive lead.**
2. If the battery will be stored for more than two months, check it at least once a month and fully charge it if necessary.
3. Fully charge the battery before installation. **NOTICE: When installing the battery, be sure the key**

[ECA16303]

is turned to “OFF”, then connect the positive lead before connecting the negative lead. [ECA16841]

4. After installation, make sure that the battery leads are properly connected to the battery terminals.

ECA16531

NOTICE

Always keep the battery charged. Storing a discharged battery can cause permanent battery damage.

PERIODIC MAINTENANCE AND ADJUSTMENT

EAU58961

Replacing the fuses

The fuse boxes and the ABS motor fuse are located behind cowling A, and the main fuse, the cruise control fuse and the brake light fuse are located behind cowling B. (See page 6-8.)

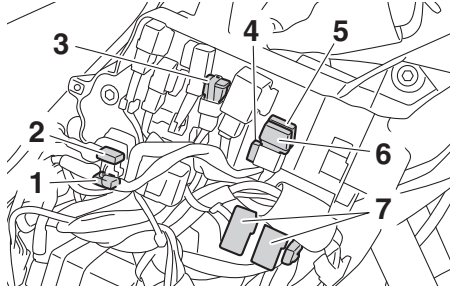

1. ABS motor fuse
2. ABS motor spare fuse
3. Main fuse
4. Spare fuse
5. Cruise control fuse
6. Brake light fuse
7. Fuse box

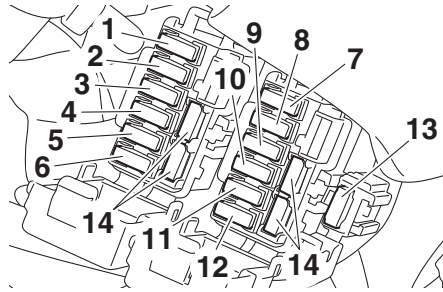

1. Headlight fuse
2. ABS solenoid fuse
3. Electronic throttle valve fuse
4. Fuel injection system fuse
5. Backup fuse (for clock and immobilizer system)
6. Radiator fan motor fuse
7. Ignition fuse
8. Signaling system fuse
9. ABS control unit fuse
10. Auxiliary DC jack fuse
11. Parking lighting fuse
12. O/P (option) fuse
13. Suspension fuse
14. Spare fuse

If a fuse is blown, replace it as follows.

1. Turn the key to “OFF” and turn off the electrical circuit in question.

2. Remove the blown fuse, and then install a new fuse of the specified amperage. **WARNING! Do not use a fuse of a higher amperage rating than recommended to avoid causing extensive damage to the electrical system and possibly a fire.** [EWA15132]

PERIODIC MAINTENANCE AND ADJUSTMENT

Specified fuses:

Main fuse:	50.0 A
Headlight fuse:	20.0 A
Brake light fuse:	1.0 A
Parking lighting fuse:	7.5 A
Signaling system fuse:	7.5 A
Ignition fuse:	20.0 A
Radiator fan motor fuse:	20.0 A
Backup fuse:	7.5 A
Electronic throttle valve fuse:	7.5 A
Fuel injection system fuse:	20.0 A
ABS solenoid fuse:	20.0 A
ABS control unit fuse:	7.5 A
ABS motor fuse:	30.0 A
Suspension fuse:	15.0 A
Cruise control fuse:	1.0 A
Auxiliary DC jack fuse:	3.0 A
O/P (option) fuse:	20.0 A

3. Turn the key to “ON” and turn on the electrical circuit in question to check if the device operates.
4. If the fuse immediately blows again, have a Yamaha dealer check the electrical system.

Replacing a headlight bulb

EAU39014

This model is equipped with halogen bulb headlights. If a headlight bulb burns out, replace it as follows.

ECA10651

NOTICE

Take care not to damage the following parts:

- **Headlight bulb**
Do not touch the glass part of the headlight bulb to keep it free from oil, otherwise the transparency of the glass, the luminosity of the bulb, and the bulb life will be adversely affected. Thoroughly clean off any dirt and fingerprints on the headlight bulb using a cloth moistened with alcohol or thinner.
- **Headlight lens**
Do not affix any type of tinted film or stickers to the headlight lens.
Do not use a headlight bulb of a wattage higher than specified.

PERIODIC MAINTENANCE AND ADJUSTMENT

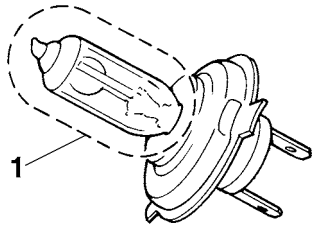

1. Do not touch the glass part of the bulb.

1. Remove the headlight bulb cover by turning it counterclockwise.

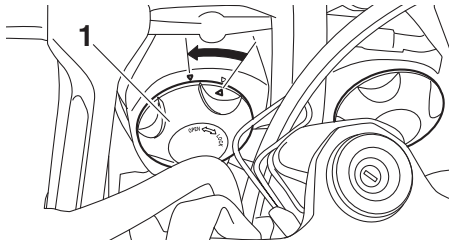

1. Headlight bulb cover

2. Disconnect the headlight coupler.

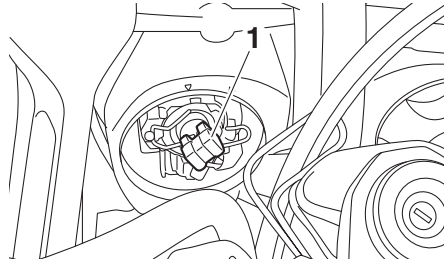

1. Headlight coupler

3. Unhook the headlight bulb holder, and then remove the burnt-out bulb.

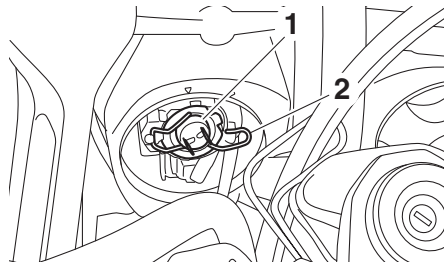

1. Headlight bulb

2. Headlight bulb holder

4. Place a new headlight bulb into position, and then secure it with the bulb holder.

5. Connect the headlight coupler.
6. Install the headlight bulb cover by turning it clockwise.
7. Have a Yamaha dealer adjust the headlight beam if necessary.

PERIODIC MAINTENANCE AND ADJUSTMENT

Replacing an auxiliary light bulb

EAU58971

This model is equipped with two auxiliary lights. If an auxiliary light bulb burns out, replace it as follows.

1. Remove the windshield by removing the screws.

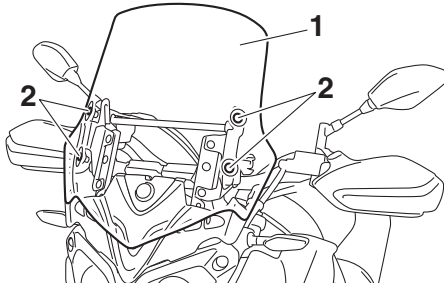

1. Windshield
2. Screw

2. Remove the cover by pulling it outward.

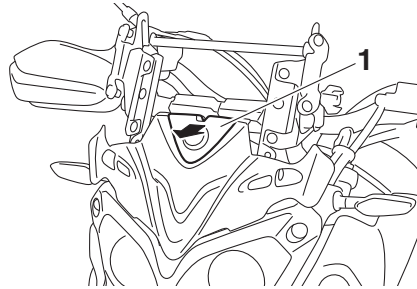

1. Cover

3. Remove the panel by removing the screws and the quick fastener screw.

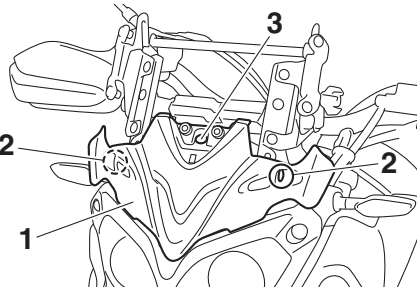

1. Panel
2. Screw
3. Quick fastener screw

4. Remove the headlight unit cover by removing the bolts.

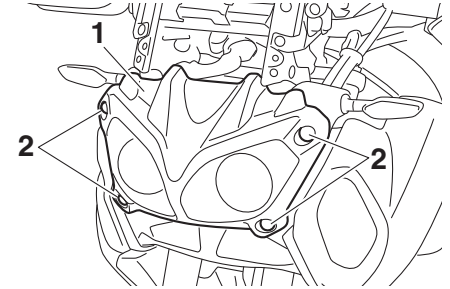

1. Headlight unit cover
2. Bolt

5. Remove the headlight unit bolts, then pull the headlight unit slightly out, making sure that it remains supported. **NOTICE: Be careful not to pull the headlight leads.**

[ECA16811]

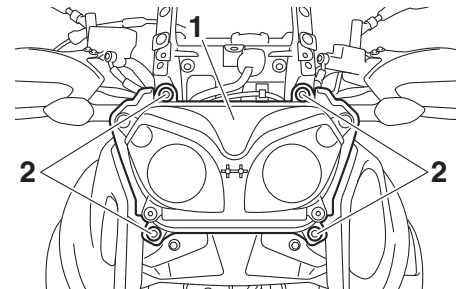

1. Headlight unit
2. Headlight unit bolt

PERIODIC MAINTENANCE AND ADJUSTMENT

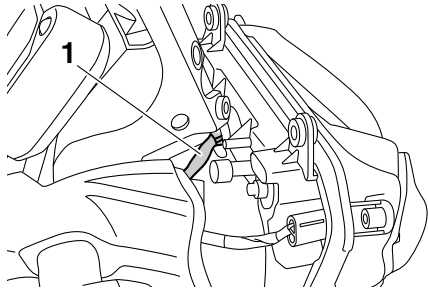

1. Headlight lead

6. Remove the auxiliary light bulb socket (together with the bulb) by turning the socket counterclockwise.

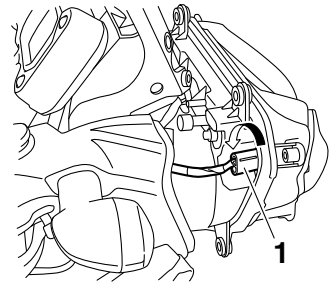

1. Auxiliary light bulb socket

7. Remove the burnt-out bulb by pulling it out.

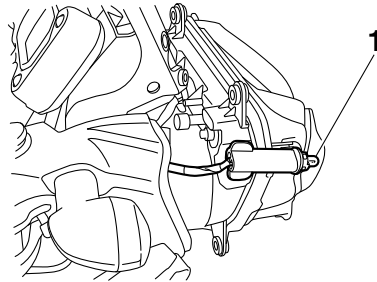

1. Auxiliary light bulb

8. Insert a new bulb into the socket.
9. Install the socket (together with the bulb) by pushing it in and turning it clockwise.
10. Install the headlight unit by installing the bolts, and then tightening them to the specified torque.

Tightening torque:

Headlight unit bolt:
7 Nm (0.7 m·kgf, 5.1 ft·lbf)

11. Install the headlight unit cover by installing the bolts.
12. Install the panel by installing the screws and the quick fastener screw.
13. Install the cover.

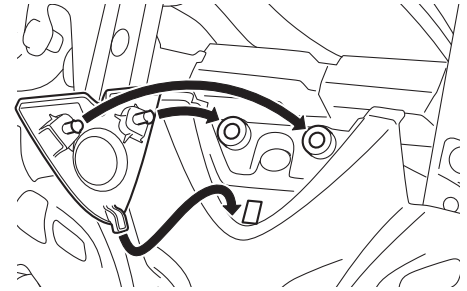

14. Install the windshield by installing the screws, and then tightening them to the specified torque. **WARNING! A loose windshield could cause an accident. Be sure to tighten the screws to the specified torque.** [EWA15511]

Tightening torque:

Windshield screw:
0.5 Nm (0.05 m·kgf, 0.36 ft·lbf)

PERIODIC MAINTENANCE AND ADJUSTMENT

Turn signal light and tail/brake light

EAU58590

This model is equipped with LED-type turn signal lights and an LED-type tail/brake light.

If a turn signal light or the tail/brake light does not come on, have a Yamaha dealer check it.

Replacing a license plate light bulb

EAU49722

1. Remove the license plate light unit bolts.

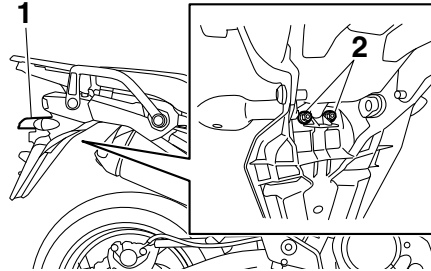

1. License plate light unit
2. License plate light unit bolt

2. Remove the license plate light bulb socket (together with the bulb) by turning it counterclockwise, and then pulling it out.

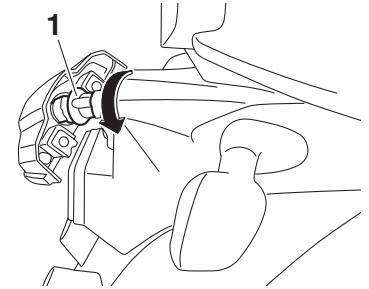

1. License plate light bulb socket

3. Remove the burnt-out bulb by pulling it out.

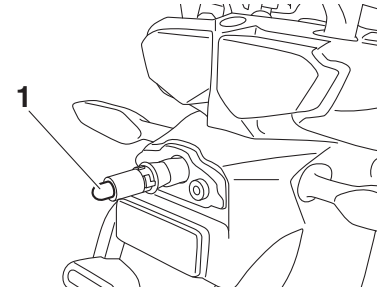

1. License plate light bulb

4. Insert a new bulb into the socket.
5. Install the socket (together with the bulb) by pushing it in, and then turning it clockwise until it stops.

PERIODIC MAINTENANCE AND ADJUSTMENT

6. Place the license plate light unit in the original position, and then install the bolts.

Troubleshooting

EAU25872

Although Yamaha motorcycles receive a thorough inspection before shipment from the factory, trouble may occur during operation. Any problem in the fuel, compression, or ignition systems, for example, can cause poor starting and loss of power.

The following troubleshooting charts represent quick and easy procedures for checking these vital systems yourself. However, should your motorcycle require any repair, take it to a Yamaha dealer, whose skilled technicians have the necessary tools, experience, and know-how to service the motorcycle properly.

Use only genuine Yamaha replacement parts. Imitation parts may look like Yamaha parts, but they are often inferior, have a shorter service life and can lead to expensive repair bills.

EWA15142



When checking the fuel system, do not smoke, and make sure there are no open flames or sparks in the area, including pilot lights from water

heaters or furnaces. Gasoline or gasoline vapors can ignite or explode, causing severe injury or property damage.

PERIODIC MAINTENANCE AND ADJUSTMENT

EAU42505

Troubleshooting charts

Starting problems or poor engine performance

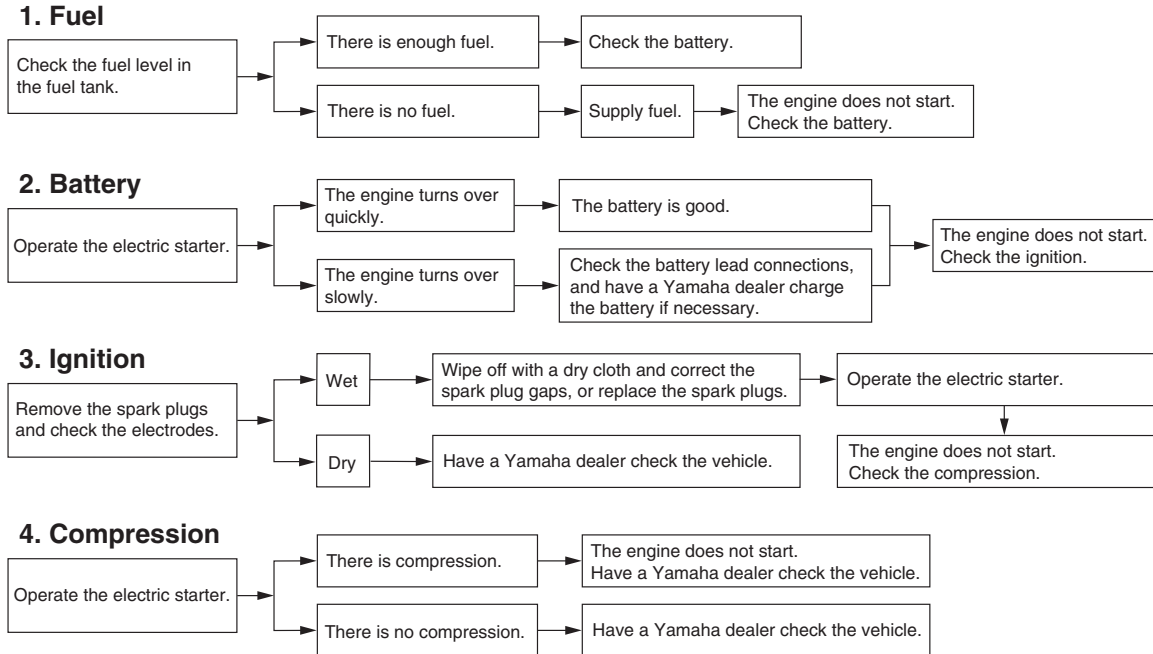

PERIODIC MAINTENANCE AND ADJUSTMENT

Engine overheating

EWAT1041

⚠ WARNING

- Do not remove the radiator cap when the engine and radiator are hot. Scalding hot fluid and steam may be blown out under pressure, which could cause serious injury. Be sure to wait until the engine has cooled.
- Place a thick rag, like a towel, over the radiator cap, and then slowly rotate the cap counterclockwise to the detent to allow any residual pressure to escape. When the hissing sound has stopped, press down on the cap while turning it counterclockwise, and then remove the cap.

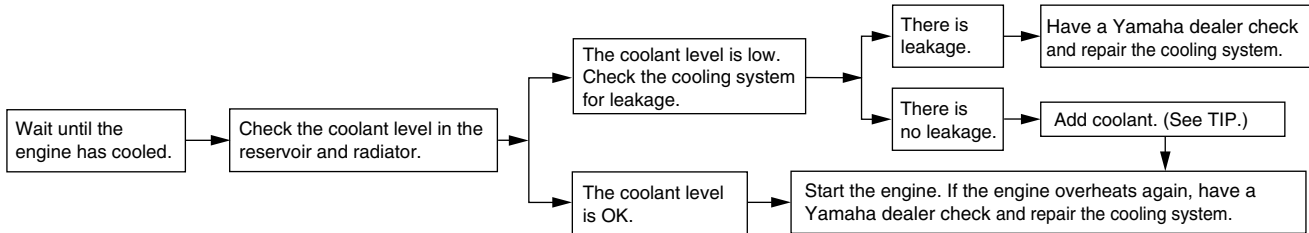

TIP

If coolant is not available, tap water can be temporarily used instead, provided that it is changed to the recommended coolant as soon as possible.

Matte color caution

EAU37834

NOTICE

Some models are equipped with matte colored finished parts. Be sure to consult a Yamaha dealer for advice on what products to use before cleaning the vehicle. Using a brush, harsh chemical products or cleaning compounds when cleaning these parts will scratch or damage their surface. Wax also should not be applied to any matte colored finished parts.

ECA15193

Care

EAU54711

While the open design of a motorcycle reveals the attractiveness of the technology, it also makes it more vulnerable. Rust and corrosion can develop even if high-quality components are used. A rusty exhaust pipe may go unnoticed on a car, however, it detracts from the overall appearance of a motorcycle. Frequent and proper care does not only comply with the terms of the warranty, but it will also keep your motorcycle looking good, extend its life and optimize its performance.

Before cleaning

1. Cover the muffler outlet with a plastic bag after the engine has cooled down.
2. Make sure that all caps and covers as well as all electrical couplers and connectors, including the spark plug caps, are tightly installed.
3. Remove extremely stubborn dirt, like oil burnt onto the crankcase, with a degreasing agent and a brush, but never apply such prod-

ucts onto seals, gaskets and wheel axles. Always rinse the dirt and degreaser off with water.

Cleaning

ECA10773

NOTICE

- Avoid using strong acidic wheel cleaners, especially on spoked wheels. If such products are used on hard-to-remove dirt, do not leave the cleaner on the affected area any longer than instructed. Also, thoroughly rinse the area off with water, immediately dry it, and then apply a corrosion protection spray.
- Improper cleaning can damage plastic parts (such as cowlings, panels, windshields, headlight lenses, meter lenses, etc.) and the mufflers. Use only a soft, clean cloth or sponge with water to clean plastic. However, if the plastic parts cannot be thoroughly cleaned with water, diluted mild detergent with water may be used. Be sure to rinse

MOTORCYCLE CARE AND STORAGE

off any detergent residue using plenty of water, as it is harmful to plastic parts.

- Do not use any harsh chemical products on plastic parts. Be sure to avoid using cloths or sponges which have been in contact with strong or abrasive cleaning products, solvent or thinner, fuel (gasoline), rust removers or inhibitors, brake fluid, antifreeze or electrolyte.
- Do not use high-pressure washers or steam-jet cleaners since they cause water seepage and deterioration in the following areas: seals (of wheel and swing-arm bearings, fork and brakes), electric components (couplers, connectors, instruments, switches and lights), breather hoses and vents.
- For motorcycles equipped with a windshield: Do not use strong cleaners or hard sponges as they will cause dulling or scratching. Some cleaning compounds for plastic may leave scratches on the wind-

shield. Test the product on a small hidden part of the windshield to make sure that it does not leave any marks. If the windshield is scratched, use a quality plastic polishing compound after washing.

After normal use

Remove dirt with warm water, a mild detergent, and a soft, clean sponge, and then rinse thoroughly with clean water. Use a toothbrush or bottlebrush for hard-to-reach areas. Stubborn dirt and insects will come off more easily if the area is covered with a wet cloth for a few minutes before cleaning.

After riding in the rain, near the sea or on salt-sprayed roads

Since sea salt or salt sprayed on roads during winter are extremely corrosive in combination with water, carry out the following steps after each ride in the rain, near the sea or on salt-sprayed roads.

TIP

Salt sprayed on roads in the winter may remain well into spring.

1. Clean the motorcycle with cold water and a mild detergent, after the engine has cooled down. **NOTICE: Do not use warm water since it increases the corrosive action of the salt.** [ECA10792]
2. After drying the motorcycle, apply a corrosion protection spray on all metal, including chrome- and nickel-plated, surfaces to prevent corrosion.

Windshield cleaning

Avoid using any alkaline or strong acid cleaner, gasoline, brake fluid, or any other solvent. Clean the windshield with a cloth or sponge dampened with a neutral detergent, and after cleaning, thoroughly wash it off with water. For additional cleaning, use Yamaha Windshield Cleaner or other quality cleaner. Some cleaning compounds for plastics may leave scratches on surfaces of the

MOTORCYCLE CARE AND STORAGE

windshield. Before using them, make a test by polishing an area which does not affect your visibility.

After cleaning

1. Dry the motorcycle with a chamois or an absorbing cloth.
2. Use a chrome polish to shine chrome, aluminum and stainless-steel parts, including the exhaust system. (Even the thermally induced discoloring of stainless-steel exhaust systems can be removed through polishing.)
3. To prevent corrosion, it is recommended to apply a corrosion protection spray on all metal, including chrome- and nickel-plated, surfaces.
4. Use spray oil as a universal cleaner to remove any remaining dirt.
5. Touch up minor paint damage caused by stones, etc.
6. Wax all painted surfaces.
7. Let the motorcycle dry completely before storing or covering it.

WARNING

EWA11132

Contaminants on the brakes or tires can cause loss of control.

- **Make sure that there is no oil or wax on the brakes or tires.**
- **If necessary, clean the brake discs and brake linings with a regular brake disc cleaner or acetone, and wash the tires with warm water and a mild detergent. Before riding at higher speeds, test the motorcycle's braking performance and cornering behavior.**

ECA10801

NOTICE

- **Apply spray oil and wax sparingly and make sure to wipe off any excess.**
- **Never apply oil or wax to any rubber and plastic parts, but treat them with a suitable care product.**
- **Avoid using abrasive polishing compounds as they will wear away the paint.**

TIP

- Consult a Yamaha dealer for advice on what products to use.
- Washing, rainy weather or humid climates can cause the headlight lens to fog. Turning the headlight on for a short period of time will help remove the moisture from the lens.

MOTORCYCLE CARE AND STORAGE

Storage

EAU49592

Short-term

Always store your motorcycle in a cool, dry place and, if necessary, protect it against dust with a porous cover. Be sure the engine and the exhaust system are cool before covering the motorcycle.

ECA10811

NOTICE

- **Storing the motorcycle in a poorly ventilated room or covering it with a tarp, while it is still wet, will allow water and humidity to seep in and cause rust.**
- **To prevent corrosion, avoid damp cellars, stables (because of the presence of ammonia) and areas where strong chemicals are stored.**

Long-term

Before storing your motorcycle for several months:

1. Follow all the instructions in the “Care” section of this chapter.

2. Fill up the fuel tank and add fuel stabilizer (if available) to prevent the fuel tank from rusting and the fuel from deteriorating.
 3. Perform the following steps to protect the cylinders, piston rings, etc. from corrosion.
 - a. Remove the spark plug caps and spark plugs.
 - b. Pour a teaspoonful of engine oil into each spark plug bore.
 - c. Install the spark plug caps onto the spark plugs, and then place the spark plugs on the cylinder head so that the electrodes are grounded. (This will limit sparking during the next step.)
 - d. Turn the engine over several times with the starter. (This will coat the cylinder walls with oil.)
- WARNING! To prevent damage or injury from sparking, make sure to ground the spark plug electrodes while turning the engine over.**

[EWA10952]

- e. Remove the spark plug caps from the spark plugs, and then install the spark plugs and the spark plug caps.
4. Lubricate all control cables and the pivoting points of all levers and pedals as well as of the side-stand/centerstand.
 5. Check and, if necessary, correct the tire air pressure, and then lift the motorcycle so that both of its wheels are off the ground. Alternatively, turn the wheels a little every month in order to prevent the tires from becoming degraded in one spot.
 6. Cover the muffler outlet with a plastic bag to prevent moisture from entering it.
 7. Remove the battery and fully charge it. Store it in a cool, dry place and charge it once a month. Do not store the battery in an excessively cold or warm place [less than 0 °C (30 °F) or more than 30 °C (90 °F)]. For more information on storing the battery, see page 6-28.

MOTORCYCLE CARE AND STORAGE

TIP _____
Make any necessary repairs before
storing the motorcycle.

SPECIFICATIONS

Dimensions:

- Overall length:
2255 mm (88.8 in)
- Overall width:
980 mm (38.6 in)
- Overall height:
1410/1470 mm (55.5/57.9 in)
- Seat height:
845/870 mm (33.3/34.3 in)
- Wheelbase:
1540 mm (60.6 in)
- Ground clearance:
190 mm (7.48 in)
- Minimum turning radius:
2700 mm (106.3 in)

Weight:

- Curb weight:
265 kg (584 lb)

Engine:

- Engine type:
Liquid cooled 4-stroke, DOHC
- Cylinder arrangement:
Inline 2-cylinder
- Displacement:
1199 cm³
- Bore × stroke:
98.0 × 79.5 mm (3.86 × 3.13 in)
- Compression ratio:
11.0 : 1
- Starting system:
Electric starter
- Lubrication system:
Dry sump

Engine oil:

- Recommended brand:
YAMALUBE
- Type:
SAE 10W-40, 10W-50, 15W-40, 20W-40 or 20W-50

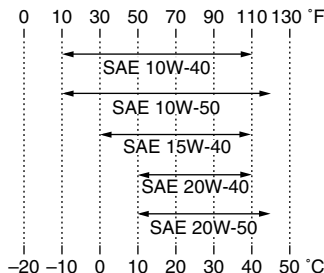

- Recommended engine oil grade:
API service SG type or higher, JASO standard MA

- Engine oil quantity:
Without oil filter cartridge replacement:
3.10 L (3.28 US qt, 2.73 Imp.qt)
With oil filter cartridge replacement:
3.40 L (3.59 US qt, 2.99 Imp.qt)

Final gear oil:

- Type:
Yamaha genuine shaft drive gear oil SAE 80W-90 API GL-5 or SAE 80 API GL-4 Hypoid gear oil
- Quantity:
0.20 L (0.21 US qt, 0.18 Imp.qt)

Coolant quantity:

- Coolant reservoir (up to the maximum level mark):
0.26 L (0.27 US qt, 0.23 Imp.qt)
- Radiator (including all routes):
1.83 L (1.93 US qt, 1.61 Imp.qt)

Air filter:

- Air filter element:
Oil-coated paper element

Fuel:

- Recommended fuel:
Premium unleaded gasoline (Gasohol (E10) acceptable)
- Fuel tank capacity:
23.0 L (6.08 US gal, 5.06 Imp.gal)
- Fuel reserve amount:
3.9 L (1.03 US gal, 0.86 Imp.gal)

Fuel injection:

- Throttle body:
ID mark:
2BS1 00

Spark plug(s):

- Manufacturer/model:
NGK/CPR8EB9
- Spark plug gap:
0.8–0.9 mm (0.031–0.035 in)

Clutch:

- Clutch type:
Wet, multiple-disc

Transmission:

- Primary reduction ratio:
1.466 (85/58)
- Final drive:
Shaft

Secondary reduction ratio:
2.987 (21/25 x 32/9)
Transmission type:
Constant mesh 6-speed
Operation:
Left foot operation
Gear ratio:
1st:
2.769 (36/13)
2nd:
2.063 (33/16)
3rd:
1.571 (33/21)
4th:
1.250 (30/24)
5th:
1.042 (25/24)
6th:
0.929 (26/28)

Chassis:

Frame type:
Backbone
Caster angle:
28.00 °
Trail:
126 mm (5.0 in)

Front tire:

Type:
Tubeless
Size:
110/80R19M/C 59V
Manufacturer/model:
BRIDGESTONE/BW501

Rear tire:

Type:
Tubeless
Size:
150/70R17M/C 69V
Manufacturer/model:
BRIDGESTONE/BW502

Loading:

Maximum load:
205 kg (452 lb)
(Total weight of rider, passenger, cargo
and accessories)

Tire air pressure (measured on cold tires):

Loading condition:
0–90 kg (0–198 lb)
Front:
225 kPa (2.25 kgf/cm², 33 psi)
Rear:
250 kPa (2.50 kgf/cm², 36 psi)
Loading condition:
90–205 kg (198–452 lb)
Front:
225 kPa (2.25 kgf/cm², 33 psi)
Rear:
290 kPa (2.90 kgf/cm², 42 psi)

Front wheel:

Wheel type:
Spoke wheel
Rim size:
19M/C x MT2.50

Rear wheel:

Wheel type:
Spoke wheel

Rim size:
17M/C x MT4.00

Unified brake system:

Operation:
Activated by front brake

Front brake:

Type:
Dual disc brake
Operation:
Right hand operation
Specified brake fluid:
DOT 4

Rear brake:

Type:
Single disc brake
Operation:
Right foot operation
Specified brake fluid:
DOT 4

Front suspension:

Type:
Telescopic fork
Spring/shock absorber type:
Coil spring/oil damper
Wheel travel:
190 mm (7.5 in)

Rear suspension:

Type:
Swingarm (link suspension)
Spring/shock absorber type:
Coil spring/gas-oil damper
Wheel travel:
190 mm (7.5 in)

SPECIFICATIONS

Electrical system:

Ignition system:

TCI

Charging system:

AC magneto

Battery:

Model:

YTZ12S

Voltage, capacity:

12 V, 11.0 Ah

Headlight:

Bulb type:

Halogen bulb

Bulb voltage, wattage × quantity:

Headlight:

12 V, 55.0 W × 2

Tail/brake light:

LED

Front turn signal light:

LED

Rear turn signal light:

LED

Auxiliary light:

12 V, 5.0 W × 2

License plate light:

12 V, 5.0 W × 1

Meter lighting:

LED

Neutral indicator light:

LED

High beam indicator light:

LED

Oil level warning light:

LED

Turn signal indicator light:

LED

Engine trouble warning light:

LED

ABS warning light:

LED

Cruise control “SET” indicator light:

LED

Cruise control “ON” indicator light:

LED

Immobilizer system indicator light:

LED

Traction control system indicator/warning light:

LED

Suspension warning light:

LED

Fuses:

Main fuse:

50.0 A

Headlight fuse:

20.0 A

Brake light fuse:

1.0 A

Signaling system fuse:

7.5 A

Ignition fuse:

20.0 A

Parking lighting fuse:

7.5 A

Radiator fan motor fuse:

20.0 A

Fuel injection system fuse:

20.0 A

ABS control unit fuse:

7.5 A

ABS motor fuse:

30.0 A

ABS solenoid fuse:

20.0 A

Suspension fuse:

15.0 A

Cruise control fuse:

1.0 A

Auxiliary DC jack fuse:

3.0 A

Backup fuse:

7.5 A

Electronic throttle valve fuse:

7.5 A

O/P (option) fuse:

20.0 A

Identification numbers

EAU53562

Record the vehicle identification number, engine serial number, and the model label information in the spaces provided below. These identification numbers are needed when registering the vehicle with the authorities in your area and when ordering spare parts from a Yamaha dealer.

VEHICLE IDENTIFICATION NUMBER:

ENGINE SERIAL NUMBER:

MODEL LABEL INFORMATION:

Vehicle identification number

EAU26401

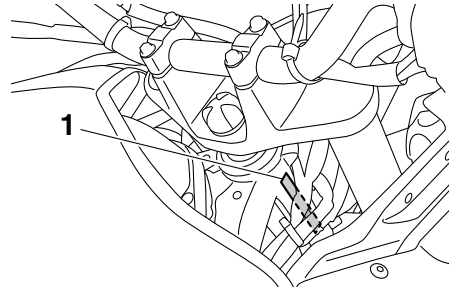

1. Vehicle identification number

The vehicle identification number is stamped into the steering head pipe. Record this number in the space provided.

TIP

The vehicle identification number is used to identify your motorcycle and may be used to register your motorcycle with the licensing authority in your area.

Engine serial number

EAU26442

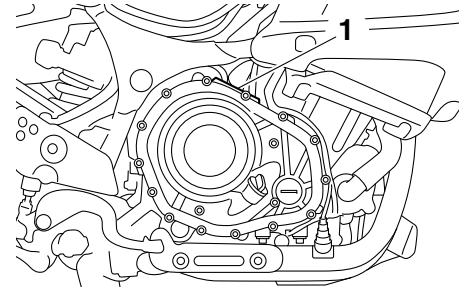

1. Engine serial number

The engine serial number is stamped into the crankcase.

Model label

EAU26471

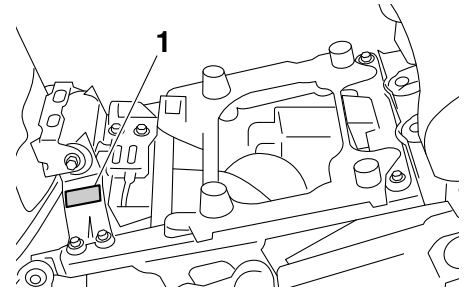

1. Model label

CONSUMER INFORMATION

The model label is affixed to the frame under the rider seat. (See page 3-34.) Record the information on this label in the space provided. This information will be needed when ordering spare parts from a Yamaha dealer.

- A**
- ABS..... 3-28
 - ABS warning light..... 3-5
 - Air filter element..... 6-17
 - Auxiliary DC jack 3-45
 - Auxiliary light bulb, replacing 6-33
- B**
- Battery 6-28
 - Brake and clutch fluids, changing 6-24
 - Brake and clutch levers, checking and lubricating..... 6-25
 - Brake and shift pedals, checking and lubricating..... 6-25
 - Brake fluid level, checking..... 6-23
 - Brake lever..... 3-27
 - Brake lever free play, checking 6-21
 - Brake light switches 6-22
 - Brake pedal 3-28
- C**
- Care..... 7-1
 - Carriers..... 3-42
 - Catalytic converter 3-33
 - Centerstand and sidestand, checking and lubricating 6-26
 - Clutch lever..... 3-26, 6-21
 - Coolant..... 6-15
 - Cowlings, removing and installing..... 6-8
 - Cruise control indicator lights..... 3-4
 - Cruise control switches..... 3-25
 - Cruise control system..... 3-7
- D**
- Dimmer/Pass switch..... 3-25
 - D-mode (drive mode)..... 3-24
- E**
- Electronically adjustable suspension system warning light 3-6
 - Engine break-in..... 5-3
 - Engine idling speed, checking 6-17
 - Engine oil and oil filter cartridge..... 6-11
 - Engine serial number 9-1
 - Engine trouble warning light 3-5
- F**
- Final gear oil..... 6-14
 - Front and rear brake pads, checking... 6-22
 - Front fork, checking 6-27
 - Fuel 3-32
 - Fuel consumption, tips for reducing 5-3
 - Fuel tank breather hose and overflow hose 3-33
 - Fuel tank cap..... 3-31
 - Fuses, replacing..... 6-30
- H**
- Handlebar switches 3-24
 - Hazard switch 3-25
 - Headlight bulb, replacing..... 6-31
 - High beam indicator light..... 3-4
 - Horn switch 3-25
- I**
- Identification numbers 9-1
 - Ignition circuit cut-off system 3-43
 - Immobilizer system 3-1
 - Immobilizer system indicator light 3-6
 - Indicator lights and warning lights 3-4
- L**
- License plate light bulb, replacing 6-35
 - Luggage strap holders 3-42
- M**
- Main switch/steering lock..... 3-2
 - Maintenance and lubrication, periodic ... 6-4
 - Maintenance, emission control system 6-3
 - Matte color, caution..... 7-1
 - Menu switch 3-25
 - Model label 9-1
 - Multi-function meter unit 3-10
- N**
- Neutral indicator light 3-4
- O**
- Oil level warning light..... 3-4
- P**
- Parking..... 5-4
 - Part locations..... 2-1
- R**
- Rider seat..... 3-34
 - Rider seat height, adjusting..... 3-35
- S**
- Safety information..... 1-1
 - Select switch 3-26
 - Shifting..... 5-2
 - Shift pedal..... 3-27
 - Sidestand..... 3-43
 - Spark plugs, checking 6-10
 - Specifications 8-1
 - Start/Engine stop switch 3-25
 - Starting the engine 5-1
 - Steering, checking..... 6-28
 - Storage 7-4
 - Suspension, adjusting the front and rear 3-37
 - Swingarm pivots, lubricating 6-27

INDEX

T

Throttle grip and cable, checking and lubricating	6-24
Throttle grip free play, checking	6-17
Tires	6-18
Tool kit	6-2
Traction control system	3-29
Traction control system indicator/ warning light	3-5
Troubleshooting	6-36
Troubleshooting charts	6-37
Turn signal indicator lights	3-4
Turn signal light and tail/brake light	6-35
Turn signal switch	3-25

V

Valve clearance	6-18
Vehicle identification number	9-1

W

Wheel bearings, checking	6-28
Wheels	6-20
Windshield	3-36

