



YAMAHA



**F20D
F25D
FT25F**

OWNER'S MANUAL

▲ Read this manual carefully before operating this outboard motor.

6BP-28199-76-E0

Read this manual carefully before operating this outboard motor. Keep this manual onboard in a waterproof bag when boating. This manual should stay with the outboard motor if it is sold.

Important manual information

EMU25108

To the owner

Thank you for selecting a Yamaha outboard motor. This Owner's Manual contains information needed for proper operation, maintenance and care. A thorough understanding of these simple instructions will help you obtain maximum enjoyment from your new Yamaha. If you have any question about the operation or maintenance of your outboard motor, please consult a Yamaha dealer.

In this Owner's Manual particularly important information is distinguished in the following ways.



: This is the safety alert symbol. It is used to alert you to potential personal injury hazards. Obey all safety messages that follow this symbol to avoid possible injury or death.

EWM00782



WARNING

A WARNING indicates a hazardous situation which, if not avoided, could result in death or serious injury.

ECM00702

NOTICE

A NOTICE indicates special precautions that must be taken to avoid damage to the outboard motor or other property.

TIP:

A TIP provides key information to make procedures easier or clearer.

Yamaha continually seeks advancements in product design and quality. Therefore, while this manual contains the most current product information available at the time of printing, there may be minor discrepancies between your machine and this manual. If

there is any question concerning this manual, please consult your Yamaha dealer.

To ensure long product life, Yamaha recommends that you use the product and perform the specified periodic inspections and maintenance by correctly following the instructions in the owner's manual. Any damage resulting from neglect of these instructions is not covered by warranty.

Some countries have laws or regulations restricting users from taking the product out of the country where it was purchased, and it may be impossible to register the product in the destination country. Additionally, the warranty may not apply in certain regions. When planning to take the product to another country, consult the dealer where the product was purchased for further information.

If the product was purchased used, please consult your closest dealer for customer re-registration, and to be eligible for the specified services.

TIP:

The F20DET, F25DE, F25DET, F25DMH, FT25FET and the standard accessories are used as a base for the explanations and illustrations in this manual. Therefore some items may not apply to every model.

EMU25122

**F20D, F25D, FT25F
OWNER'S MANUAL**
©2013 by Yamaha Motor Co., Ltd.
1st Edition, November 2013
All rights reserved.
Any reprinting or unauthorized use
without the written permission of
Yamaha Motor Co., Ltd.
is expressly prohibited.
Printed in Japan

Table of contents

Safety information	1	Multiple batteries	13
Outboard motor safety	1	Without a rectifier or Rectifier	
Propeller.....	1	Regulator	13
Rotating parts.....	1	Propeller selection	13
Hot parts.....	1	Start-in-gear protection	14
Electric shock.....	1	Engine oil requirements	14
Power trim and tilt.....	1	Fuel requirements	15
Engine shut-off cord (lanyard)	1	Gasoline	15
Gasoline	1	Muddy or acidic water.....	15
Gasoline exposure and spills	2	Anti-fouling paint.....	15
Carbon monoxide.....	2	Motor disposal requirements.....	15
Modifications	2	Emergency equipment.....	16
Boating safety	2		
Alcohol and drugs.....	2	Components	17
Personal flotation devices (PFDs).....	2	Components diagram.....	17
People in the water.....	2	Fuel tank.....	18
Passengers	2	Fuel joint.....	19
Overloading	2	Fuel gauge	19
Avoid collisions.....	3	Fuel tank cap.....	19
Weather.....	3	Air vent screw.....	19
Passenger training	3	Remote control box	19
Boating safety publications.....	3	Remote control lever	19
Laws and regulations	3	Neutral interlock trigger	20
		Neutral throttle lever	20
General information	4	Tiller handle	20
Identification numbers record.....	4	Gear shift lever	20
Outboard motor serial number	4	Throttle grip	20
Key number.....	4	Throttle indicator	21
EC Declaration of Conformity		Throttle friction adjuster.....	21
(DoC)	4	Engine shut-off cord (lanyard) and	
CE Marking	4	clip.....	21
Read manuals and labels.....	6	Engine stop button	22
Warning labels	6	Manual starter handle.....	22
		Main switch.....	22
Specifications and requirements ...	10	Steering friction adjuster.....	23
Specifications	10	Power trim and tilt switch on remote	
Installation requirements	12	control	23
Boat horsepower rating	12	Power trim and tilt switch on bottom	
Mounting motor	12	cowling	24
Remote control requirements	12	Trim tab with anode.....	24
Battery requirements.....	12	Trim tab	25
Battery specifications	12	Trim rod (tilt pin)	25
Mounting battery.....	13	Tilt lock mechanism.....	25
		Tilt support knob.....	26

Table of contents

Tilt support bar	26	Cooling water	44
Cowling lock lever(s) (turn type)	26	Warming up engine	44
Flushing device	27	Manual start and electric start models	44
Alert indicator	27	Checks after engine warm up	45
Instruments and indicators	28	Shifting	45
Indicators	28	Stop switches	45
Low oil pressure-alert indicator	28	Shifting	45
Overheat-alert indicator	28	Stopping boat	46
Engine control system	29	Stopping engine	47
Alert system	29	Procedure	47
Overheat alert	29	Trimming outboard motor	47
Low oil pressure alert	29	Adjusting trim angle for manual tilt models	48
Installation	31	Adjusting trim angle (Power trim and tilt)	49
Installation	31	Adjusting boat trim	49
Mounting the outboard motor	31	Tilting up and down	50
Clamping the outboard motor	32	Procedure for tilting up (manual tilt models)	50
Operation	34	Procedure for tilting up (power trim and tilt models)	51
First-time operation	34	Procedure for tilting down (manual tilt models)	52
Fill engine oil	34	Procedure for tilting down (power trim and tilt models)	52
Breaking in engine	34	Shallow water	53
Getting to know your boat	34	Cruising in shallow water (manual tilt models)	53
Checks before starting engine	34	Power trim and tilt models	54
Fuel level	35	Cruising in other conditions	55
Remove the top cowling	35	Maintenance	56
Fuel system	35	Transporting and storing outboard motor	56
Controls	35	Clamp screw mounting models	56
Engine shut-off cord (lanyard)	36	Storing outboard motor	57
Engine oil	36	Procedure	57
Engine	37	Lubrication	58
Flushing device	37	Flushing power unit	59
Install top cowling	37	Cleaning the outboard motor	60
Checking power trim and tilt system	38	Checking painted surface of outboard motor	60
Battery	38	Periodic maintenance	60
Filling fuel	38		
Operating engine	39		
Sending fuel (portable tank)	40		
Starting engine	40		
Checks after starting engine	44		

Table of contents

Replacement parts	60
Severe operating conditions.....	61
Maintenance chart 1	62
Maintenance chart 2.....	64
Greasing.....	65
Cleaning and adjusting spark plug	66
Checking fuel filter.....	67
Inspecting idle speed.....	67
Changing engine oil.....	68
Inspecting wiring and connectors	70
Checking propeller	70
Removing propeller	71
Installing propeller	71
Changing gear oil	72
Cleaning fuel tank.....	73
Inspecting and replacing anode(s)	74
Checking battery (for electric start models)	75
Connecting the battery	75
Disconnecting the battery.....	76
Trouble Recovery	77
Troubleshooting	77
Temporary action in emergency.....	80
Impact damage.....	80
Replacing fuse.....	80
Power trim and tilt will not operate	81
Starter will not operate	81
Emergency starting engine (manual start model).....	82
Emergency starting engine (electric start model)	84
Treatment of submerged motor.....	85
INDEX	86

EMU33623

Outboard motor safety

Observe these precautions at all times.

EMU36502

Propeller

People can be injured or killed if they come in contact with the propeller. The propeller can keep moving even when the motor is in neutral, and sharp edges of the propeller can cut even when stationary.

- Stop the engine when a person is in the water near you.
- Keep people out of reach of the propeller, even when the engine is off.

EMU33631

Rotating parts

Hands, feet, hair, jewelry, clothing, PFD straps, etc. can become entangled with internal rotating parts of the engine, resulting in serious injury or death.

Keep the top cowling in place whenever possible. Do not remove or replace the cowling with the engine running.

Only operate the engine with the cowling removed according to the specific instructions in the manual. Keep hands, feet, hair, jewelry, clothing, PFD straps, etc. away from any exposed moving parts.

EMU33641

Hot parts

During and after operation, engine parts are hot enough to cause burns. Avoid touching any parts under the top cowling until the engine has cooled.

EMU33651

Electric shock

Do not touch any electrical parts while starting or operating the engine. They can cause shock or electrocution.

EMU33661

Power trim and tilt

Body parts can be crushed between the mo-

tor and the clamp bracket when the motor is trimmed or tilted. Keep body parts out of this area at all times. Be sure no one is in this area before operating the power trim and tilt mechanism.

The power trim and tilt switches operate even when the main switch is off. Keep people away from the switches whenever working around the motor.

Never get under the lower unit while it is tilted, even when the tilt support lever is locked. Severe injury could occur if the outboard motor accidentally falls.

EMU33672

Engine shut-off cord (lanyard)

Attach the engine shut-off cord so that the engine stops if the operator falls overboard or leaves the helm. This prevents the boat from running away under power and leaving people stranded, or running over people or objects.

Always attach the engine shut-off cord to a secure place on your clothing or your arm or leg while operating. Do not remove it to leave the helm while the boat is moving. Do not attach the cord to clothing that could tear loose, or route the cord where it could become entangled, preventing it from functioning.

Do not route the cord where it is likely to be accidentally pulled out. If the cord is pulled during operation, the engine will shut off and you will lose most steering control. The boat could slow rapidly, throwing people and objects forward.

EMU33811

Gasoline

Gasoline and its vapors are highly flammable and explosive. Always, refuel according to the procedure on page 39 to reduce the risk of fire and explosion.

Safety information

EMU33821

Gasoline exposure and spills

Take care not to spill gasoline. If gasoline spills, wipe it up immediately with dry rags. Dispose of rags properly.

If any gasoline spills onto your skin, immediately wash with soap and water. Change clothing if gasoline spills on it.

If you swallow gasoline, inhale a lot of gasoline vapor, or get gasoline in your eyes, get immediate medical attention. Never siphon fuel by mouth.

EMU33901

Carbon monoxide

This product emits exhaust gases which contain carbon monoxide, a colorless, odorless gas which may cause brain damage or death when inhaled. Symptoms include nausea, dizziness, and drowsiness. Keep cockpit and cabin areas well ventilated. Avoid blocking exhaust outlets.

EMU33781

Modifications

Do not attempt to modify this outboard motor. Modifications to your outboard motor may reduce safety and reliability, and render the outboard unsafe or illegal to use.

EMU33741

Boating safety

This section includes a few of the many important safety precautions that you should follow when boating.

EMU33711

Alcohol and drugs

Never operate after drinking alcohol or taking drugs. Intoxication is one of the most common factors contributing to boating fatalities.

EMU40281

Personal flotation devices (PFDs)

Have an approved PFD on board for every occupant. Yamaha recommends that you must wear a PFD whenever boating. At a

minimum, children and non-swimmers should always wear PFDs, and everyone should wear PFDs when there are potentially hazardous boating conditions.

EMU33732

People in the water

Always watch carefully for people in the water, such as swimmers, skiers, or divers, whenever the engine is running. When someone is in the water near the boat, shift into neutral and stop the engine.

Stay away from swimming areas. Swimmers can be hard to see.

The propeller can keep moving even when the motor is in neutral. Stop the engine when a person is in the water near you.

EMU33752

Passengers

Consult your boat manufacturer's instructions for details about appropriate passenger locations in your boat and be sure all passengers are positioned properly before accelerating and when operating above an idle speed. Standing or sitting in non-designated locations may result in being thrown either overboard or within the boat due to waves, wakes, or sudden changes in speed or direction. Even when people are positioned properly, alert your passengers if you must make any unusual maneuver. Always avoid jumping waves or wakes.

EMU33762

Overloading

Do not overload the boat. Consult the boat capacity plate or boat manufacturer for maximum weight and number of passengers. Be sure that weight is properly distributed according to the boat manufacturer's instructions. Overloading or incorrect weight distribution can compromise the boat's handling and lead to an accident, capsizing or swamping.

EMU33773

Avoid collisions

Scan constantly for people, objects, and other boats. Be alert for conditions that limit your visibility or block your vision of others.

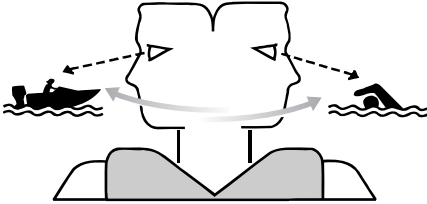

ZMU06025

Operate defensively at safe speeds and keep a safe distance away from people, objects, and other boats.

- Do not follow directly behind other boats or waterskiers.
- Avoid sharp turns or other maneuvers that make it hard for others to avoid you or understand where you are going.
- Avoid areas with submerged objects or shallow water.
- Ride within your limits and avoid aggressive maneuvers to reduce the risk of loss of control, ejection, and collision.
- Take early action to avoid collisions. Remember, boats do not have brakes, and stopping the engine or reducing throttle can reduce the ability to steer. If you are not sure that you can stop in time before hitting an obstacle, apply throttle and turn in another direction.

EMU33791

Weather

Stay informed about the weather. Check weather forecasts before boating. Avoid boating in hazardous weather.

EMU33881

Passenger training

Make sure at least one other passenger is trained to operate the boat in the event of an emergency.

EMU33891

Boating safety publications

Be informed about boating safety. Additional publications and information can be obtained from many boating organizations.

EMU33601

Laws and regulations

Know the marine laws and regulations where you will be boating- and obey them. Several sets of rules prevail according to geographic location, but all are basically the same as the International Rules of the Road.

General information

EMU25172

Identification numbers record

EMU25185

Outboard motor serial number

The outboard motor serial number is stamped on the label attached to the port side of the clamp bracket.

Record your outboard motor serial number in the spaces provided to assist you in ordering spare parts from your Yamaha dealer or for reference in case your outboard motor is stolen.

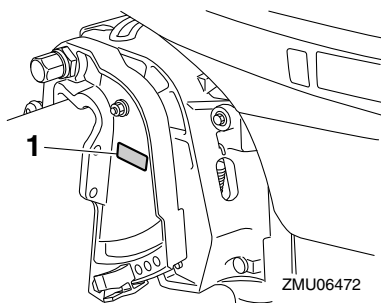

1. Outboard motor serial number location

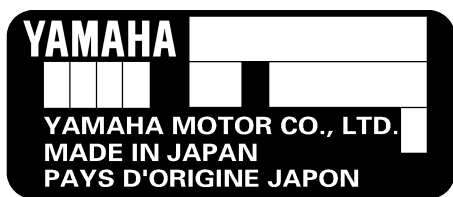

EMU25192

Key number

If a main key switch is equipped with the motor, the key identification number is stamped on your key as shown in the illustration. Record this number in the space provided for

reference in case you need a new key.

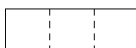

ZMU01693

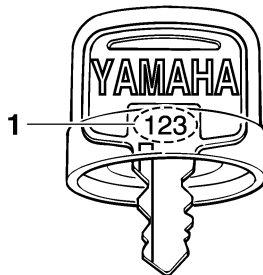

1. Key number

EMU37292

EC Declaration of Conformity (DoC)

This outboard motor conforms to certain portions of the European Parliament directive relating to machinery.

Each conformed outboard motor accompanied with EC DoC. EC DoC contains the following information;

- Name of Engine Manufacture
- Model name
- Product code of model (Approved model code)
- Code of conformed directives

EMU25207

CE Marking

Outboard motors affixed with this "CE" marking conform with the directives of; 2006/42/EC, 94/25/EC - 2003/44/EC and 2004/108/EC.

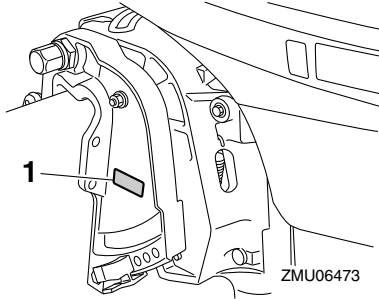

1. CE marking location

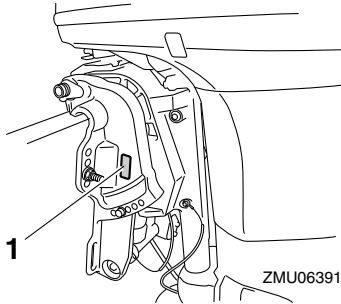

1. CE marking location



ZMU06040

General information

EMU33524

Read manuals and labels

Before operating or working on this outboard motor:

- Read this manual.
- Read any manuals supplied with the boat.
- Read all labels on the outboard motor and the boat.

If you need any additional information, contact your Yamaha dealer.

EMU33834

Warning labels

If these labels are damaged or missing, contact your Yamaha dealer for replacements.

F25DMH

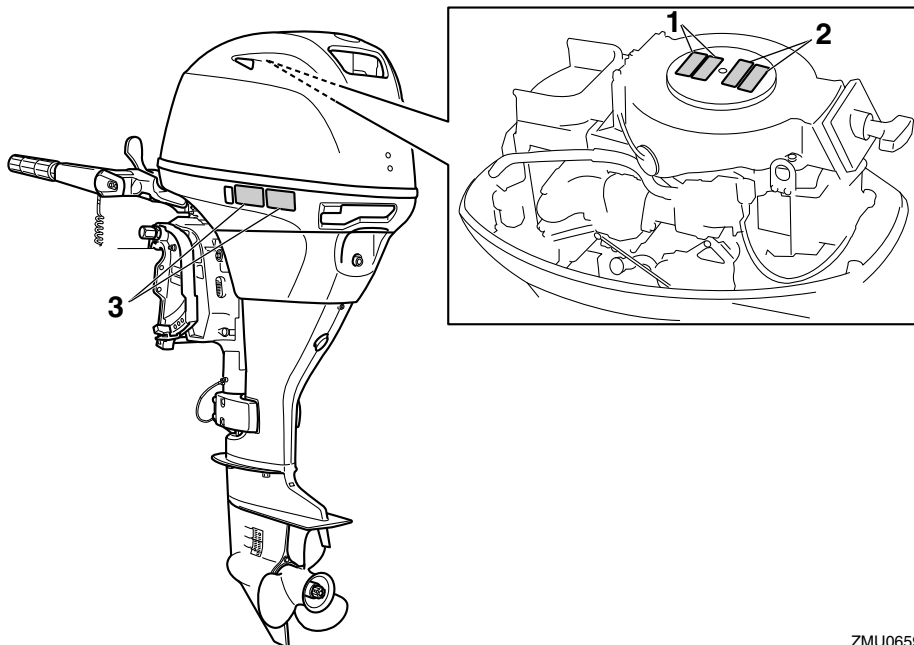

ZMU06594

General information

F20DET, F25DE, F25DET, FT25FET

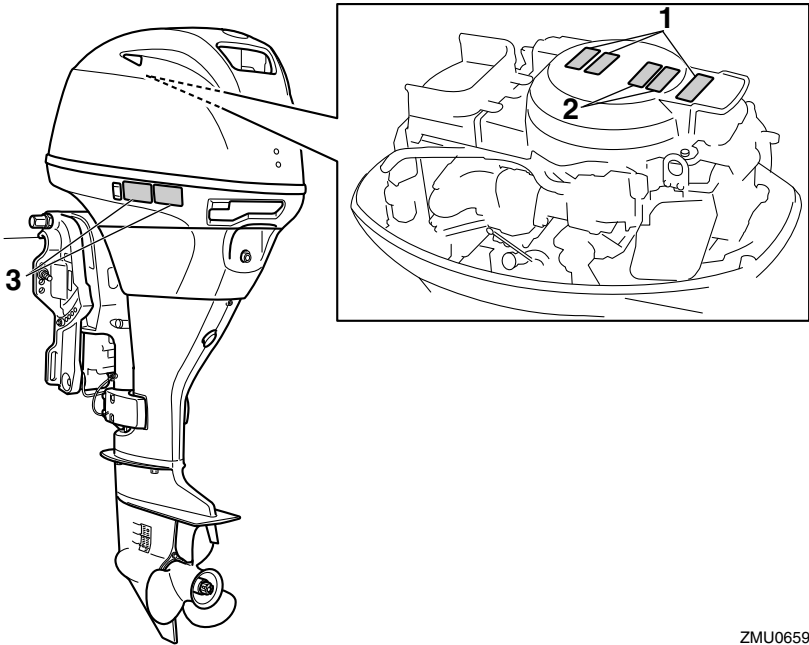

ZMU06593

General information

1

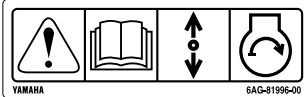

2



3

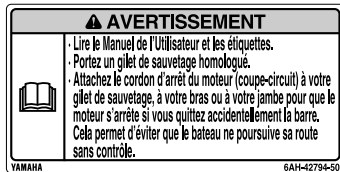
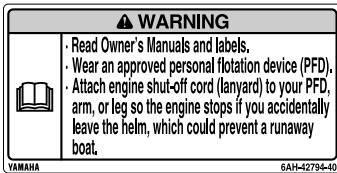

EMU33913

Contents of labels

The above warning labels mean as follows.

1

EWM01692

⚠ WARNING _____
Emergency starting does not have start-in-gear protection. Ensure shift control is in neutral before starting engine.

2

EWM01682

⚠ WARNING _____

- Keep hands, hair, and clothing away from rotating parts while the engine is running.
- Do not touch or remove electrical parts when starting or during operation.

ZMU05746

3

EWM01672

⚠ WARNING _____

- Read Owner's Manuals and labels.
- Wear an approved personal flotation device (PFD).
- Attach engine shut-off cord (lanyard) to your PFD, arm, or leg so the engine stops if you accidentally leave the helm, which could prevent a runaway boat.

General information

EMU33844

Symbols

The following symbols mean as follows.

Notice/Warning



ZMU05696

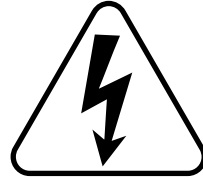

ZMU05666

Electrical hazard

Remote control lever/gear shift lever operating direction, dual direction



ZMU05667

Read Owner's Manual



ZMU05664

Engine start/ Engine cranking

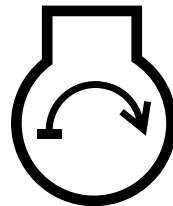

ZMU05668

Hazard caused by continuous rotation

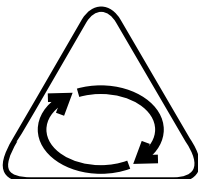

ZMU05665

Specifications and requirements

EMU34522

Specifications

TIP:

“(AL)” stated in the specification data below represents the numerical value for the aluminum propeller installed.

Likewise, “(SUS)” represents the value for stainless steel propeller installed and “(PL)” for plastic propeller installed.

EMU2821U

Dimension and weight:

Overall length:

F20DET 692 mm (27.2 in)
F25DE 692 mm (27.2 in)
F25DET 692 mm (27.2 in)
F25DMH 1181 mm (46.5 in)
FT25FET 692 mm (27.2 in)

Overall width:

F20DET 398 mm (15.7 in)
F25DE 398 mm (15.7 in)
F25DET 398 mm (15.7 in)
F25DMH 412 mm (16.2 in)
FT25FET 398 mm (15.7 in)

Overall height S:

F25DE 1156 mm (45.5 in)
F25DMH 1156 mm (45.5 in)

Overall height L:

F20DET 1283 mm (50.5 in)
F25DE 1283 mm (50.5 in)
F25DET 1283 mm (50.5 in)
F25DMH 1283 mm (50.5 in)
FT25FET 1311 mm (51.6 in)

Motor transom height S:

F25DE 423 mm (16.7 in)
F25DMH 423 mm (16.7 in)

Motor transom height L:

F20DET 550 mm (21.7 in)
F25DE 550 mm (21.7 in)
F25DET 550 mm (21.7 in)
F25DMH 550 mm (21.7 in)

FT25FET 536 mm (21.1 in)

Dry weight (AL) S:

F25DE 78 kg (172 lb)
F25DMH 77 kg (170 lb)

Dry weight (AL) L:

F20DET 82 kg (181 lb)
F25DE 79 kg (174 lb)
F25DET 82 kg (181 lb)
F25DMH 78 kg (172 lb)
FT25FET 92 kg (203 lb)

Performance:

Full throttle operating range:

F20DET 4500–5500 r/min
F25DE 5000–6000 r/min
F25DET 5000–6000 r/min
F25DMH 5000–6000 r/min
FT25FET 5000–6000 r/min

Rated power:

F20DET 14.7 kW (20 HP)
F25DE 18.4 kW (25 HP)
F25DET 18.4 kW (25 HP)
F25DMH 18.4 kW (25 HP)
FT25FET 18.4 kW (25 HP)

Idle speed (in neutral):

925–1025 r/min

Power unit:

Type:

4-stroke SOHC L2 4 valves

Total displacement:

498 cm³ (30.4 c.i.)

Bore × stroke:

65.0 × 75.0 mm (2.56 × 2.95 in)

Ignition system:

CDI

Spark plug (NGK):

DPR6EB-9

Spark plug gap:

0.8–0.9 mm (0.031–0.035 in)

Steering system:

F20DET Remote steering
F25DE Remote steering

Specifications and requirements

F25DET Remote steering

F25DMH Tiller handle

FT25FET Remote steering

Starting system:

F20DET Electric starter

F25DE Electric starter

F25DET Electric starter

F25DMH Manual starter

FT25FET Electric starter

Starting carburetion system:

Prime start

Valve clearance IN (cold engine):

0.15–0.25 mm (0.0059–0.0098 in)

Valve clearance EX (cold engine):

0.25–0.35 mm (0.0098–0.0138 in)

Cold cranking amps (CCA/EN):

F20DET 347–411 A

F25DE 347–411 A

F25DET 347–411 A

FT25FET 347–411 A

Min. rated capacity (20HR/IEC):

F20DET 40 Ah

F25DE 40 Ah

F25DET 40 Ah

FT25FET 40 Ah

Maximum generator output:

14 A

Lower unit:

Gear shift positions:

Forward-neutral-reverse

Gear ratio:

F20DET 2.08(27/13)

F25DE 2.08(27/13)

F25DET 2.08(27/13)

F25DMH 2.08(27/13)

FT25FET 2.42(29/12)

Trim and tilt system:

F20DET Power trim and tilt

F25DE Manual tilt

F25DET Power trim and tilt

F25DMH Manual tilt

FT25FET Power trim and tilt

Propeller mark:

F20DET F

F25DE F

F25DET F

F25DMH F

FT25FET G

Fuel and oil:

Recommended fuel:

Regular unleaded gasoline

Min. research octane number (RON):

90

Fuel tank capacity:

25 L (6.60 US gal, 5.50 Imp.gal)

Recommended engine oil:

YAMALUBE 4 or 4-stroke outboard motor oil

Recommended engine oil grade 1:

SAE 10W-30/10W-40/5W-30

API SE/SF/SG/SH/SJ/SL

Engine oil quantity (without oil filter replacement):

1.4 L (1.48 US qt, 1.23 Imp.qt)

Engine oil quantity (with oil filter replacement):

1.6 L (1.69 US qt, 1.41 Imp.qt)

Lubrication system:

Wet sump

Recommended gear oil:

YAMALUBE outboard gear oil or Hypoid gear oil

Recommended gear oil grade:

SAE 90 API GL-4

Gear oil quantity:

F20DET 0.320 L (0.338 US qt, 0.282 Imp.qt)

F25DE 0.320 L (0.338 US qt, 0.282 Imp.qt)

F25DET 0.320 L (0.338 US qt, 0.282 Imp.qt)

Specifications and requirements

F25DMH 0.320 L (0.338 US qt, 0.282 Imp.qt)

FT25FET 0.430 L (0.455 US qt, 0.378 Imp.qt)

Tightening torque:

Spark plug:

17 Nm (1.73 kgf-m, 12.5 ft-lb)

Propeller nut:

34 Nm (3.47 kgf-m, 25.1 ft-lb)

Engine oil drain bolt:

27 Nm (2.75 kgf-m, 19.9 ft-lb)

Engine oil filter:

18 Nm (1.84 kgf-m, 13.3 ft-lb)

Noise and vibration level:

Operator sound pressure level (ICOMIA 39/94):

84.2 dB(A)

Vibration on tiller handle (ICOMIA 38/94):

F25DMH Vibration on tiller handle is under 2.5 m/s²

EMU33555

Installation requirements

EMU33565

Boat horsepower rating

EWM01561

WARNING

Overpowering a boat can cause severe instability.

Before installing the outboard motor(s), confirm that the total horsepower of your outboard motor(s) does not exceed the boat's maximum horsepower rating. See the boat's capacity plate or contact the manufacturer.

EMU33572

Mounting motor

EWM01571

WARNING

- **Improper mounting of the outboard motor could result in hazardous conditions such as poor handling, loss of control, or fire hazards.**

- **Because the motor is very heavy, special equipment and training is required to mount it safely.**

Your dealer or other person experienced in proper rigging should mount the motor using correct equipment and complete rigging instructions. For further information, see page 31.

EMU33582

Remote control requirements

EWM01581

WARNING

- **If the engine starts in gear, the boat can move suddenly and unexpectedly, possibly causing a collision or throwing passengers overboard.**
- **If the engine ever starts in gear, the start-in-gear protection device is not working correctly and you should discontinue using the outboard. Contact your Yamaha dealer.**

The remote control unit must be equipped with a start-in-gear protection device(s). This device prevents the engine from starting unless it is in neutral.

EMU25695

Battery requirements

EMU25723

Battery specifications

Cold cranking amps (CCA/EN):

F20DET 347–411 A

F25DE 347–411 A

F25DET 347–411 A

FT25FET 347–411 A

Min. rated capacity (20HR/IEC):

F20DET 40 Ah

F25DE 40 Ah

F25DET 40 Ah

FT25FET 40 Ah

The engine cannot be started if battery voltage is too low.

Specifications and requirements

EMU36291

Mounting battery

Mount the battery holder securely in a dry, well-ventilated, vibration-free location in the boat. **WARNING! Do not put flammable items, or loose heavy or metal objects in the same compartment as the battery. Fire, explosion or sparks could result.**

[EWM01821]

EMU36301

Multiple batteries

To connect multiple batteries, such as for multiple engine configurations or for an accessory battery, consult your Yamaha dealer about battery selection and correct wiring.

EMU44770

Without a rectifier or Rectifier Regulator

ECM01091

NOTICE

A battery cannot be connected to models that do not have a rectifier or Rectifier Regulator.

If you wish to use a battery with the models without a rectifier or Rectifier Regulator, install an optional Rectifier Regulator.

Install an optional Rectifier Regulator or use accessories rated to withstand 18 volts or higher with the above models. Consult your Yamaha dealer for details on installing an optional Rectifier Regulator.

EMU34196

Propeller selection

Next to selecting an outboard motor, selecting the right propeller is one of the most important purchasing decisions a boater can make. The type, size, and design of your propeller have a direct impact on acceleration, top speed, fuel economy, and even engine life. Yamaha designs and manufactures propellers for every Yamaha outboard motor

and every application.

Your outboard motor came with a Yamaha propeller selected to perform well over a range of applications, but there may be uses where a different propeller would be more appropriate.

Your Yamaha dealer can help you select the right propeller for your boating needs. Select a propeller that will allow the engine to reach the middle or upper half of the operating range at full throttle with the maximum boatload. Generally, select a larger pitch propeller for a smaller operating load and a smaller pitch propeller for a heavier load. If you carry loads that vary widely, select the propeller that lets the engine run in the proper range for your maximum load but remember that you may need to reduce your throttle setting to stay within the recommended engine speed range when carrying lighter loads.

To check the propeller, see page 70.

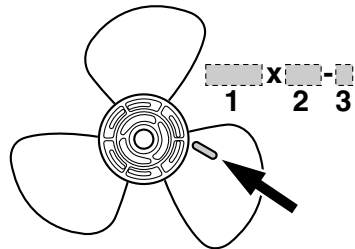

ZMU04604

1. Propeller diameter in inches
2. Propeller pitch in inches
3. Type of propeller (propeller mark)

Specifications and requirements

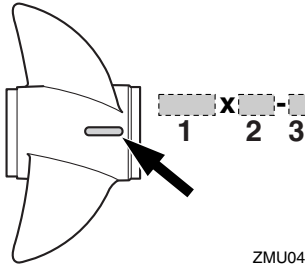

ZMU04605

1. Propeller diameter in inches
2. Propeller pitch in inches
3. Type of propeller (propeller mark)

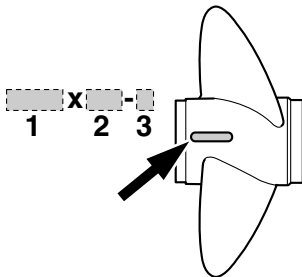

ZMU04606

1. Propeller diameter in inches
2. Propeller pitch in inches
3. Type of propeller (propeller mark)

EMU25771

Start-in-gear protection

Yamaha outboard motors or Yamaha-approved remote control units are equipped with start-in-gear protection device(s). This feature permits the engine to be started only when it is in neutral. Always select neutral before starting the engine.

EMU41953

Engine oil requirements

Select an oil grade according to the average temperatures in the area where the outboard

motor will be used.

Recommended engine oil:

YAMALUBE 4 or 4-stroke outboard motor oil

Recommended engine oil grade 1:

SAE 10W-30/10W-40/5W-30
API SE/SF/SG/SH/SJ/SL

Recommended engine oil grade 2:

SAE 15W-40/20W-40/20W-50
API SH/SJ/SL

Engine oil quantity (without oil filter replacement):

1.4 L (1.48 US qt, 1.23 Imp.qt)

Engine oil quantity (with oil filter replacement):

1.6 L (1.69 US qt, 1.41 Imp.qt)

If oil grades listed under Recommended engine oil grade 1 are not available, select an alternative oil grade listed under Recommended engine oil grade 2.

Recommended engine oil grade 1

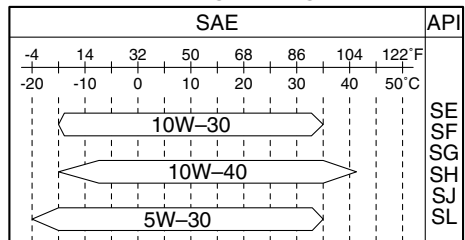

ZMU06854

Recommended engine oil grade 2

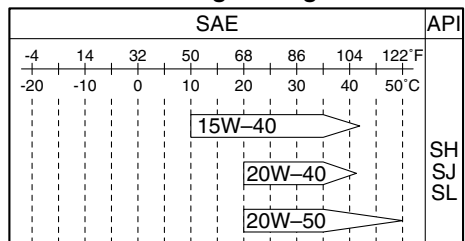

ZMU06855

Specifications and requirements

EMU36361

Fuel requirements

EMU40202

Gasoline

Use a good quality gasoline that meets the minimum octane rating. If knocking or ping-ing occurs, use a different brand of gasoline or premium unleaded fuel.

Recommended fuel:

Regular unleaded gasoline

Min. research octane number (RON):
90

ECM01982

NOTICE

- **Do not use leaded gasoline. Leaded gasoline can seriously damage the engine.**
- **Avoid getting water and contaminants in the fuel tank. Contaminated fuel can cause poor performance or engine damage. Use only fresh gasoline that has been stored in clean containers.**

Gasohol

There are two types of gasohol: gasohol containing ethanol (E10) and that containing methanol. Ethanol can be used if the ethanol content does not exceed 10% and the fuel meets the minimum octane ratings. E85 is a fuel containing 85% ethanol and must not be used in your outboard motor. All ethanol blends containing more than 10% ethanol can cause fuel system damage or cause engine starting and running problems. Yamaha does not recommend gasohol containing methanol because it can cause fuel system damage or engine performance problems. It is recommended that you install a water-separating marine fuel filter assembly (10 micron minimum) between your boat's fuel tank and outboard motor when using ethanol.

Ethanol is known to allow moisture to be absorbed into boat fuel tanks and systems. Moisture in the fuel can cause corrosion of metallic fuel system components, starting and running complaints and require additional fuel system maintenance.

EMU36881

Muddy or acidic water

Yamaha strongly recommends that you have your dealer install the optional chromium-plated water pump kit if you use the outboard motor in muddy or acidic water conditions. However, depending on the model it might not be required.

EMU36331

Anti-fouling paint

A clean hull improves boat performance. The boat bottom should be kept as clean of marine growth as possible. If necessary, the boat bottom can be coated with an anti-fouling paint approved for your area to inhibit marine growth.

Do not use anti-fouling paint which includes copper or graphite. These paints can cause more rapid engine corrosion.

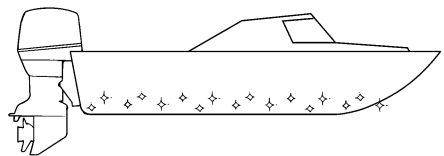

ZMU05176

EMU36342

Motor disposal requirements

Never illegally discard (dump) the motor. Yamaha recommends consulting the dealer about discarding the motor.

Specifications and requirements

EMU36353

Emergency equipment

Keep the following items onboard in case there is trouble with the outboard motor.

- A tool kit with assorted screwdrivers, pliers, wrenches (including metric sizes), and electrical tape.
- Waterproof flashlight with extra batteries.
- An extra engine shut-off cord (lanyard) with clip.
- Spare parts, such as an extra set of spark plugs.

Consult your Yamaha dealer for details.

EMU2579Z

Components diagram

TIP:

* May not be exactly as shown; also may not be included as standard equipment on all models (order from dealer).

F25DMH

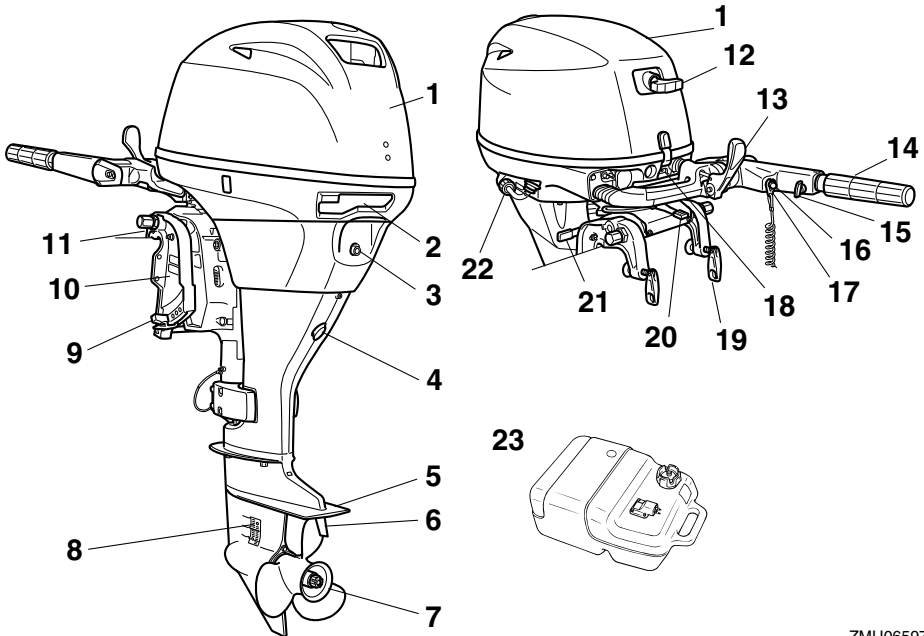

1. Top cowling
2. Cowling lock lever
3. Idle hole
4. Drain screw
5. Anti-cavitation plate
6. Trim tab
7. Propeller
8. Cooling water inlet
9. Trim rod
10. Clamp bracket
11. Restraint cable attachment

12. Manual starter handle
13. Gear shift lever
14. Throttle grip
15. Throttle friction adjuster
16. Engine stop button/Engine shut-off switch
17. Clip
18. Alert indicator
19. Clamp screw
20. Steering friction adjuster
21. Tilt lock lever
22. Flushing device
23. Fuel tank

ZMU06597

Components

F20DET, F25DE, F25DET, FT25FET

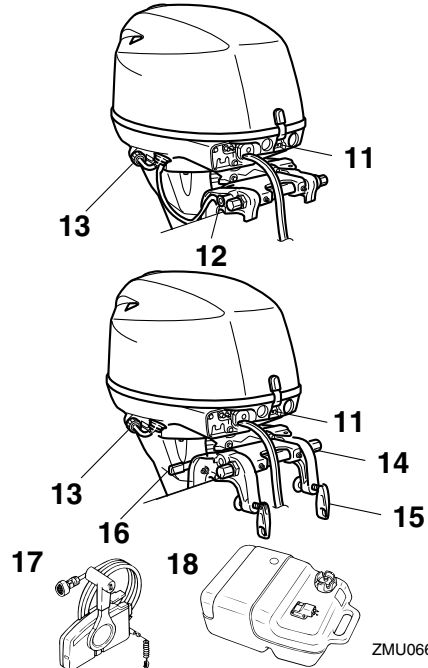
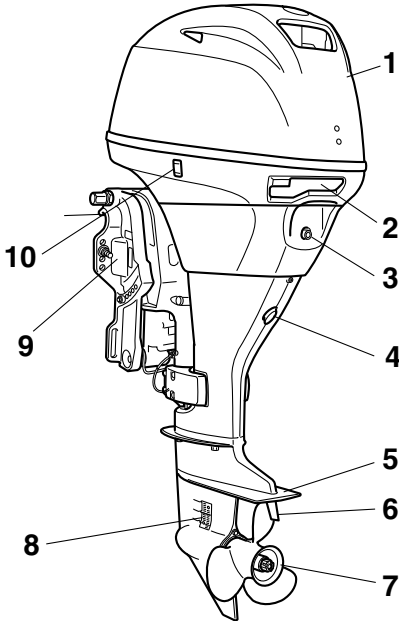

ZMU06602

EMU25804

Fuel tank

If your model was equipped with a portable fuel tank, its function is as follows.

EWM00021

WARNING

The fuel tank supplied with this engine is its dedicated fuel reservoir and must not be used as a fuel storage container. Commercial users should conform to relevant licensing or approval authority regulations.

1. Top cowling
2. Cowling lock lever
3. Idle hole
4. Drain screw
5. Anti-cavitation plate
6. Trim tab
7. Propeller
8. Cooling water inlet
9. Clamp bracket
10. Power trim and tilt switch*
11. Alert indicator
12. Tilt support knob*
13. Flushing device
14. Restraint cable attachment*
15. Clamp screw*
16. Tilt lock lever*
17. Remote control box (side mount type)
18. Fuel tank

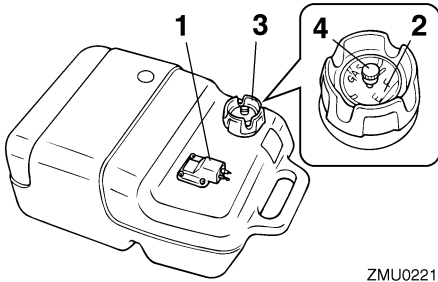

ZMU02219

1. Fuel joint
2. Fuel gauge
3. Fuel tank cap
4. Air vent screw

EMU25831

Fuel joint

This joint is used to connect the fuel line.

EMU25842

Fuel gauge

This gauge is located on either the fuel tank cap or on the fuel joint base. It shows the approximate amount of fuel remaining in the tank.

EMU25851

Fuel tank cap

This cap seals the fuel tank. When removed, the tank can be filled with fuel. To remove the cap, turn it counterclockwise.

EMU25861

Air vent screw

This screw is on the fuel tank cap. To loosen the screw, turn it counterclockwise.

EMU26182

Remote control box

The remote control lever actuates both the shifter and the throttle. The electrical switches are mounted on the remote control box.

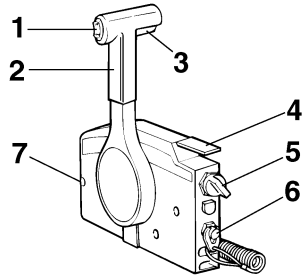

ZMU01723

1. Power trim and tilt switch
2. Remote control lever
3. Neutral interlock trigger
4. Neutral throttle lever
5. Main switch
6. Engine shut-off switch
7. Throttle friction adjuster

EMU26191

Remote control lever

Moving the lever forward from the neutral position engages forward gear. Pulling the lever back from neutral engages reverse. The engine will continue to run at idle until the lever is moved about 35° (a detent can be felt). Moving the lever farther opens the throttle, and the engine will begin to accelerate.

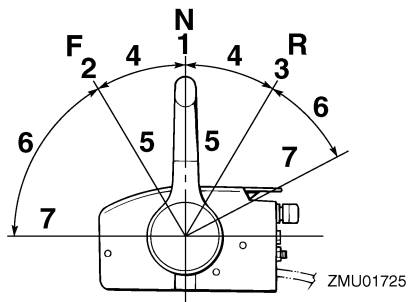

ZMU01725

1. Neutral "N"
2. Forward "F"
3. Reverse "R"
4. Shift
5. Fully closed

Components

- 6. Throttle
- 7. Fully open

EMU26202

Neutral interlock trigger

To shift out of neutral, first pull the neutral interlock trigger up.

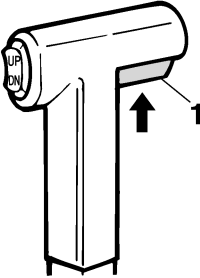

ZMU01727

- 1. Neutral interlock trigger

EMU26213

Neutral throttle lever

To open the throttle without shifting into either forward or reverse, put the remote control lever in the neutral position and lift the neutral throttle lever.

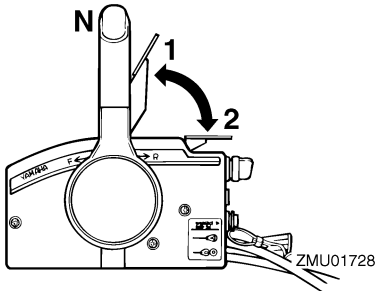

- 1. Fully open
- 2. Fully closed

TIP:

The neutral throttle lever will operate only when the remote control lever is in neutral. The remote control lever will operate only

when the neutral throttle lever is in the closed position.

EMU25914

Tiller handle

To change direction, move the tiller handle to the left or right as necessary.

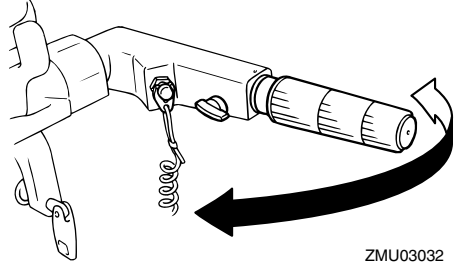

ZMU03032

EMU25925

Gear shift lever

Move the gear shift lever forward to engage the forward gear or rearward to engage the reverse gear.

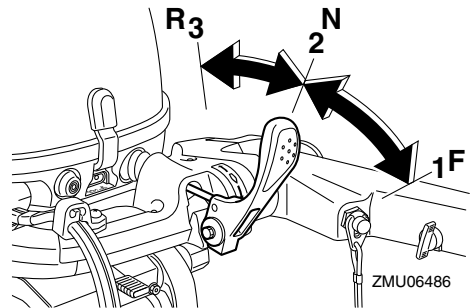

ZMU06486

- 1. Forward "F"
- 2. Neutral "N"
- 3. Reverse "R"

EMU25943

Throttle grip

The throttle grip is on the tiller handle. Turn the grip counterclockwise to increase speed and clockwise to decrease speed.

or throttle grip, which could result in an accident. [EWM00033]

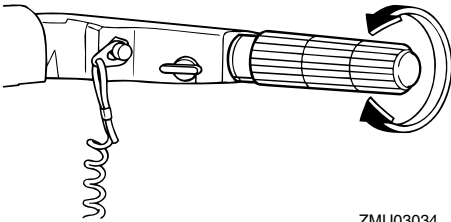

ZMU03034

EMU25963

Throttle indicator

The fuel consumption curve on the throttle indicator shows the relative amount of fuel consumed for each throttle position. Choose the setting that offers the best performance and fuel economy for the desired operation.

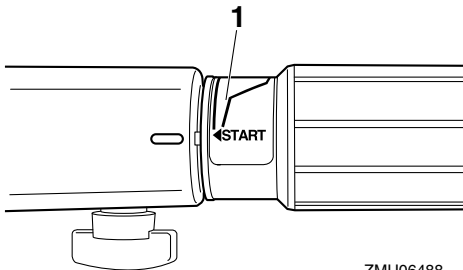

ZMU06488

1. Throttle indicator

EMU25977

Throttle friction adjuster

A friction device provides adjustable resistance to movement of the throttle grip or the remote control lever, and can be set according to operator preference.

To increase resistance, turn the adjuster clockwise. To decrease resistance, turn the adjuster counterclockwise. **WARNING! Do not overtighten the friction adjuster. If there is too much resistance, it could be difficult to move the remote control lever**

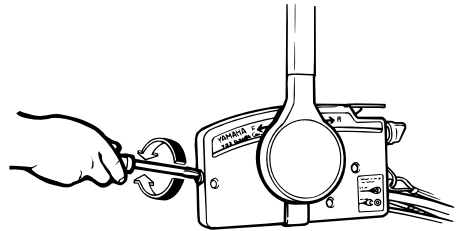

ZMU03169

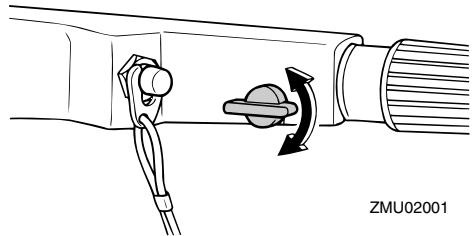

ZMU02001

When constant speed is desired, tighten the adjuster to maintain the desired throttle setting.

EMU25996

Engine shut-off cord (lanyard) and clip

The clip must be attached to the engine shut-off switch for the engine to run. The cord should be attached to a secure place on the operator's clothing, or arm or leg. Should the operator fall overboard or leave the helm, the cord will pull out the clip, stopping ignition to the engine. This will prevent the boat from running away under power. **WARNING! Attach the engine shut-off cord to a secure place on your clothing, or your arm or leg while operating. Do not attach the cord to clothing that could tear loose. Do not route the cord where it could become en-**

Components

tangled, preventing it from functioning. Avoid accidentally pulling the cord during normal operation. Loss of engine power means the loss of most steering control. Also, without engine power, the boat could slow rapidly. This could cause people and objects in the boat to be thrown forward. [EWM00123]

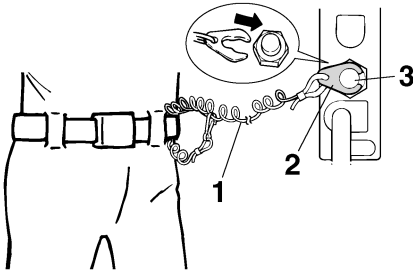

ZMU01716

1. Cord
2. Clip
3. Engine shut-off switch

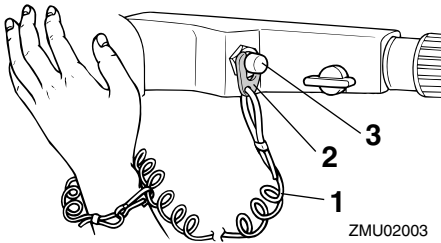

ZMU02003

1. Cord
2. Clip
3. Engine shut-off switch

EMU26004

Engine stop button

The engine stop button stops the engine when the button is pushed.

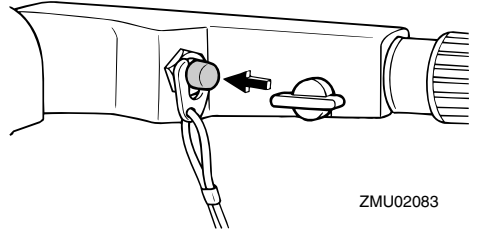

ZMU02083

EMU26075

Manual starter handle

The manual starter handle is used to crank and start the engine.

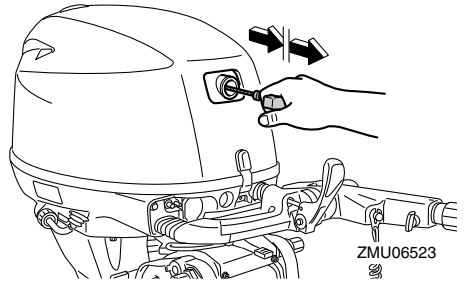

ZMU06523

EMU26092

Main switch

The main switch controls the ignition system; its operation is described below.

● "OFF" (off)

With the main switch in the "OFF" (off) position, the electrical circuits are off, and the key can be removed.

● "ON" (on)

With the main switch in the "ON" (on) position, the electrical circuits are on, and the key cannot be removed.

● "START" (start)

With the main switch in the "START" (start) position, the starter motor turns to start the engine. When the key is released, it returns

automatically to the “ON” (on) position.

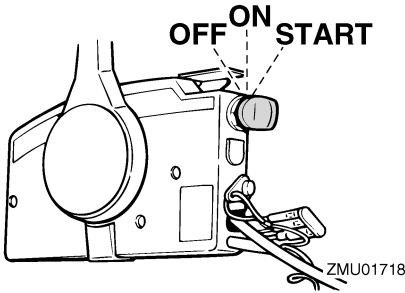

EMU31433

Steering friction adjuster

A friction device provides adjustable resistance to the steering mechanism, and can be set according to operator preference. An adjuster lever is located on the bottom of the tiller handle bracket.

To increase resistance, turn the lever to the port side “A”.

To decrease resistance, turn the lever to the starboard side “B”.

EWM00041



Do not overtighten the friction adjuster. If there is too much resistance, it could be difficult to steer, which could result in an accident.

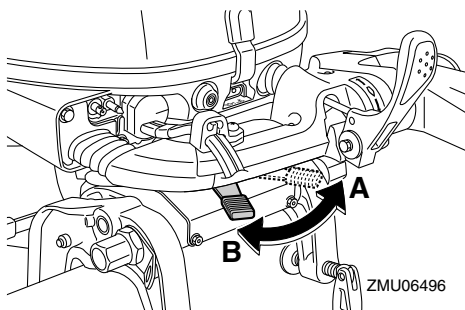

If the resistance does not increase even when the lever is turned to the port side “A”, make sure that the nut is tightened to the

specified torque.

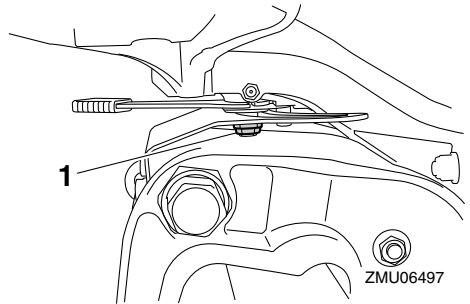

1. Nut

Nut tightening torque:

4.0 Nm (0.41 kgf-m, 3.0 ft-lb)

TIP:

- Steering movement is blocked when the adjuster lever is set to the “A” position.
- Check the tiller handle for smooth movement when the lever is turned to the starboard side “B”.
- Do not apply lubricants such as grease to the friction areas of the steering friction adjuster.

EMU32054

Power trim and tilt switch on remote control

The power trim and tilt system adjusts the outboard motor angle in relation to the transom. Pushing the switch “UP” (up) trims the outboard motor up, and then tilts it up. Pushing the switch “DN” (down) tilts the outboard motor down and trims it down. When the switch is released, the outboard motor will stop in its current position. For instructions on using the power trim and tilt switch, see pages 47 and 50.

Components

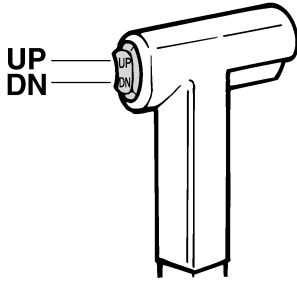

ZMU01720

EMU26156

Power trim and tilt switch on bottom cowling

The power trim and tilt switch is located on the side of the bottom cowling. Pushing the switch “UP” (up) trims the outboard motor up, and then tilts it up. Pushing the switch “DN” (down) tilts the outboard motor down and trims it down. When the switch is released, the outboard motor will stop in its current position.

For instructions on using the power trim and tilt switch, see page 50.

EWM01032

WARNING

Use the power trim and tilt switch located on the bottom cowling only when the boat is at a complete stop with the engine off. Attempting to use this switch while the boat is moving could increase the risk of falling overboard and could distract the operator, increasing the risk of collision with another boat or an obstacle.

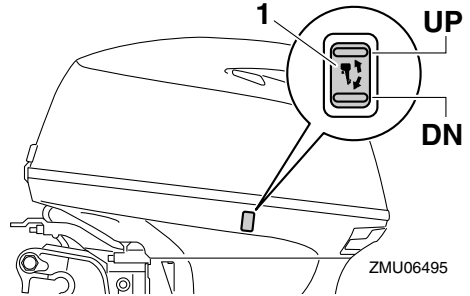

ZMU06495

1. Power trim and tilt switch

EMU26245

Trim tab with anode

EWM00841

WARNING

An improperly adjusted trim tab could cause difficult steering. Always test run after the trim tab has been installed or replaced to be sure steering is correct. Be sure you have tightened the bolt after adjusting the trim tab.

The trim tab should be adjusted so that the steering control can be turned to either the right or left by applying the same amount of force.

If the boat tends to veer to the left (port side), turn the trim tab rear end to the port side “A” in the figure. If the boat tends to veer to the right (starboard side), turn the trim tab end to the starboard side “B” in the figure.

ECM00841

NOTICE

The trim tab also serves as an anode to protect the engine from electrochemical corrosion. Never paint the trim tab as it will become ineffective as an anode.

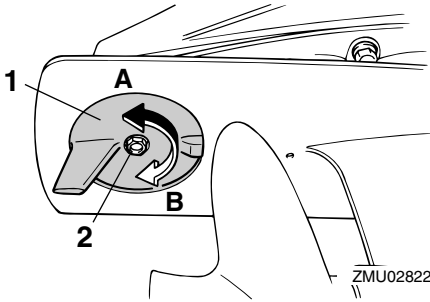

1. Trim tab
2. Bolt

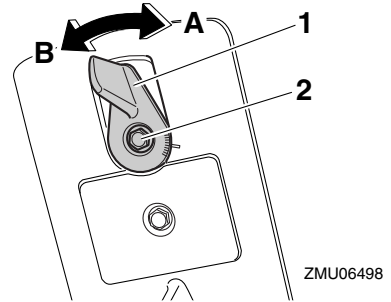

1. Trim tab
2. Bolt

Bolt tightening torque:
18 Nm (1.84 kgf-m, 13.3 ft-lb)

EMU26254

Trim tab

EWM00841



WARNING

An improperly adjusted trim tab could cause difficult steering. Always test run after the trim tab has been installed or replaced to be sure steering is correct. Be sure you have tightened the bolt after adjusting the trim tab.

The trim tab should be adjusted so that the steering control can be turned to either the right or left by applying the same amount of force.

If the boat tends to veer to the left (port side), turn the trim tab rear end to the port side “A” in the figure.

If the boat tends to veer to the right (starboard side), turn the trim tab end to the starboard side “B” in the figure.

Bolt tightening torque:
8 Nm (0.82 kgf-m, 5.9 ft-lb)

EMU26263

Trim rod (tilt pin)

The position of the trim rod determines the minimum trim angle of the outboard motor in relation to the transom.

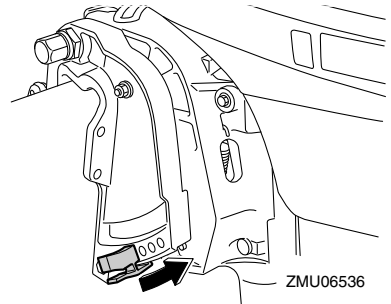

EMU30441



Tilt lock mechanism

The tilt lock mechanism is used to prevent the outboard motor from lifting out of the water when in reverse gear.

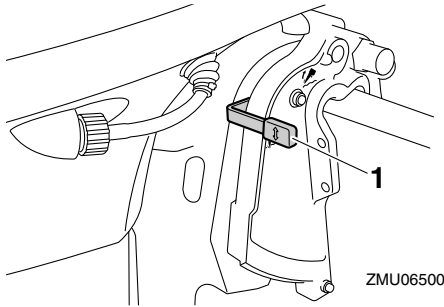
Components



1. Tilt lock lever

To tilt the outboard motor up, set the tilt lock lever to the “” (up) position. To tilt the outboard motor down, set the tilt lock lever to the “” (down) position.

EMU26322

Tilt support knob

To keep the outboard motor in the tilted up position, push the tilt support knob under the swivel bracket.

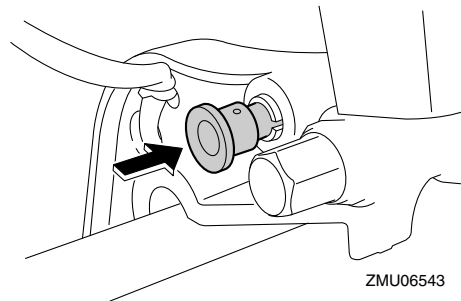

ECM00661

NOTICE

Do not use the tilt support lever or knob when trailering the boat. The outboard motor could shake loose from the tilt support and fall. If the motor cannot be trailered in the normal running position, use an additional support device to secure it in the tilt position.

EMU26334

Tilt support bar

The tilt support bar keeps the outboard motor in the tilted up position.

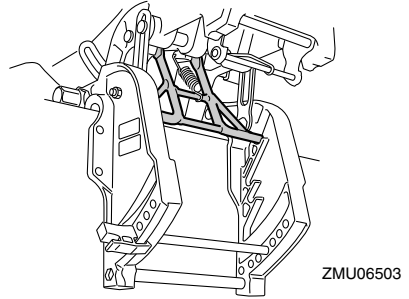

ECM01661

NOTICE

Do not use the tilt support bar when trailering the boat. The outboard motor could shake loose from the tilt support and fall. If the motor cannot be trailered in the normal running position, use an additional support device to secure it in the tilt position.

EMU26374

Cowling lock lever(s) (turn type)

To remove the engine top cowling, turn the cowling lock lever(s) and lift off the cowling. When installing the cowling, check to be sure it fits properly in the rubber seal. Then lock the cowling again by returning the cowling lock lever(s) to the lock position.

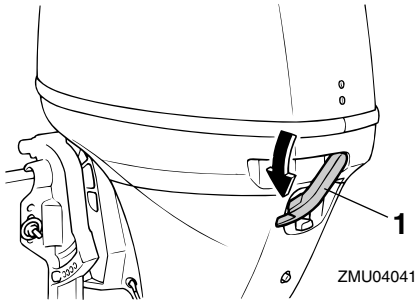

1. Cowl lock lever(s)

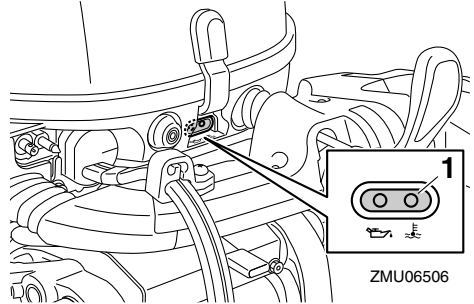

1. Alert indicator

EMU26464

Flushing device

This device is used to clean the cooling water passages of the motor using a garden hose and tap water.

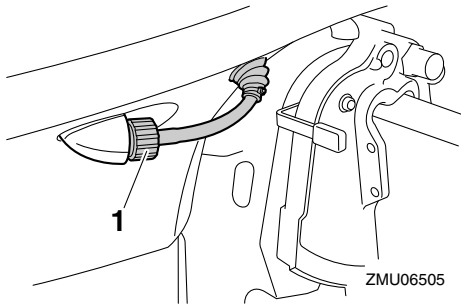

1. Flushing device

TIP:

For details on usage, see page 59.

EMU26305

Alert indicator

If the engine develops a condition which is cause for alert, the indicator lights up. For details on how to read the alert indicator, see page 29.

Instruments and indicators

EMU36016

Indicators

EMU36025

Low oil pressure-alert indicator

If oil pressure drops too low, this indicator will light up. For further information, see page 29.

ECM00023

NOTICE

- Do not continue to run the engine if the low oil pressure-alert indicator is on and the engine oil level is lower. Serious engine damage will occur.
- The low oil pressure-alert indicator does not indicate the engine oil level. Use the oil dipstick to check the remaining oil quantity. For further information, see page 36.

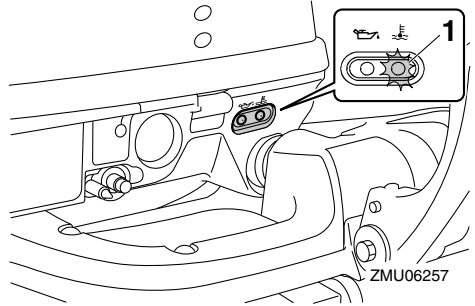

1. Overheat-alert indicator

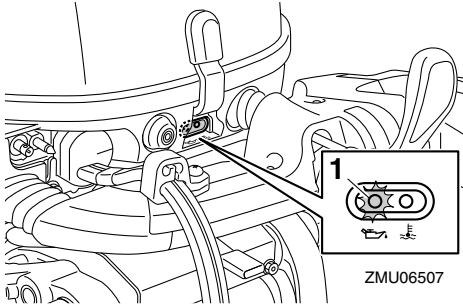

1. Low oil pressure-alert indicator

EMU36034

Overheat-alert indicator

If the engine temperature rises too high, this indicator will light up. For further information on reading the indicator, see page 29.

ECM00053

NOTICE

Do not continue to run the engine if the overheat-alert indicator is on. Serious engine damage will occur.

Engine control system

EMU26804

Alert system

ECM00092

NOTICE

Do not continue to operate the engine if a alert device has activated. Consult your Yamaha dealer if the problem cannot be located and corrected.

EMU2681D

Overheat alert

This engine has an overheat-alert device. If the engine temperature rises too high, the alert device will activate.

- The engine speed will automatically decrease to about 2000 r/min.
- The overheat-alert indicator will light or blink.

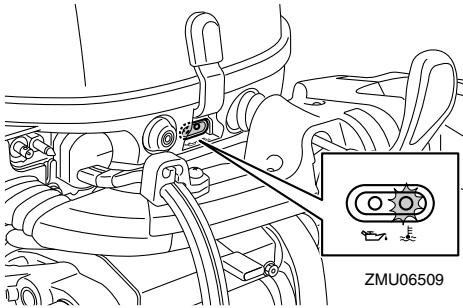

- The buzzer will sound (if equipped on the tiller handle, remote control box, or main switch panel).

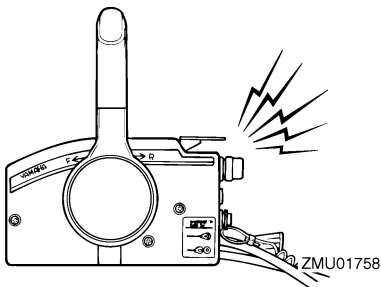

If the alert system has activated, stop the en-

gine and check the cooling water inlets:

- Check trim angle to be sure that the cooling water inlet is submerged.
- Check the cooling water inlet for clogging.

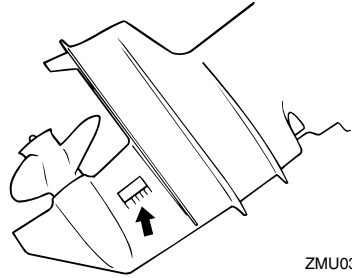

ZMU03026

EMU3016C

Low oil pressure alert

If the oil pressure drops too low, the alert device will activate.

- The engine speed will automatically decrease to about 2000 r/min. If equipped with a low oil pressure-alert indicator, it will light or blink.

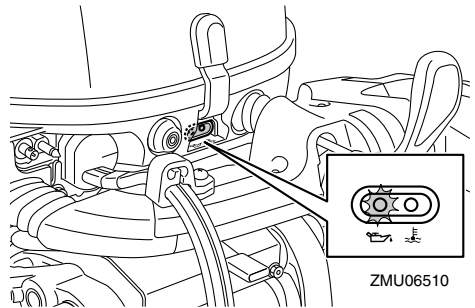

- The buzzer will sound (if equipped on the tiller handle, remote control box, or main switch panel).

Engine control system

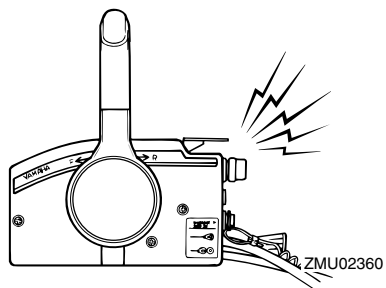

If the alert system has activated, stop the engine as soon as it is safe to do so. Check the oil level and add oil as needed. If the oil level is correct and the alert device does not switch off, consult your Yamaha dealer.

EMU26903

Installation

The information presented in this section is intended as reference only. It is not possible to provide complete instructions for every possible boat and motor combination. Proper mounting depends in part on experience and the specific boat and motor combination.

EWMO1591

WARNING

- **Overpowering a boat could cause severe instability. Do not install an outboard motor with more horsepower than the maximum rating on the capacity plate of the boat. If the boat does not have a capacity plate, consult the boat manufacturer.**
- **Improper mounting of the outboard motor could result in hazardous conditions such as poor handling, loss of control, or fire hazards. For permanently mounted models, your dealer or other person experienced in proper rigging should mount the motor.**

EMU33471

Mounting the outboard motor

The outboard motor should be mounted so that the boat is well balanced. Otherwise, the boat could be hard to steer. For single-engine boats, mount the outboard motor on the centerline (keel line) of the boat.

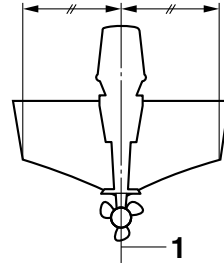

ZMU01760

1. Center line (keel line)

EMU26926

Mounting height

To run your boat at optimum efficiency, the water resistance (drag) of the boat and outboard motor must be made as little as possible. The mounting height of the outboard motor greatly affects the water resistance. If the mounting height is too high, cavitation tends to occur, thus reducing the propulsion; and if the propeller tips cut the air, the engine speed will rise abnormally and cause the engine to overheat. If the mounting height is too low, the water resistance will increase and thereby reduce engine efficiency. Mount the outboard motor so that the anti-cavitation plate is between the bottom of the boat and a level 25 mm (1 in) below it.

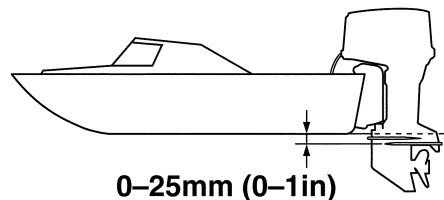

ZMU05167

Installation

ECM01635

NOTICE

- Make sure that the idle hole is high enough to prevent water from entering the engine even if the boat is stationary with the maximum load.
- Incorrect engine height or obstructions to the smooth flow of water (such as the design or condition of the boat, or accessories, such as transom ladders or depth finder transducers) can create airborne water spray while the boat is cruising. If the outboard motor is operated continuously in the presence of airborne water spray, enough water could enter the engine through the air intake opening in the top cowling to cause severe engine damage. Remove the cause of the airborne water spray.

TIP:

- The optimum mounting height of the outboard motor is affected by the boat and motor combination and the desired use. Test runs at different heights can help determine the optimum mounting height. Consult your Yamaha dealer or boat manufacturer for further information on determining the proper mounting height.
- For instructions on setting the trim angle of the outboard motor, see page 47.

EMU26974

Clamping the outboard motor

1. Place the outboard motor on the transom so that it is positioned as close to the center as possible. Tighten the transom clamp screws evenly and securely. Occasionally check the clamp screws for tightness during operation of the outboard motor because they could become loose due to engine vibration. **WARNING! Loose clamp screws**

could allow the outboard motor to fall off or move on the transom. This could cause loss of control and serious injury. Make sure the clamp screws are tightened securely. Occasionally check the screws for tightness during operation. [EWM00643]

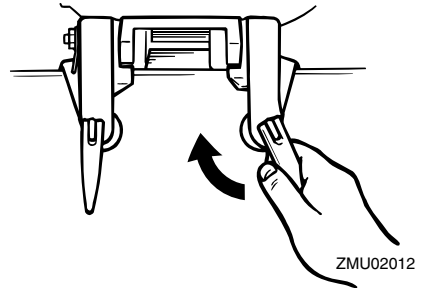

ZMU02012

2. If the restraint cable attachment is equipped on your engine, a restraint cable or chain should be used. Attach one end to the restraint cable attachment and the other to a secure mounting point on the boat. Otherwise the engine could be completely lost if it accidentally falls off the transom.

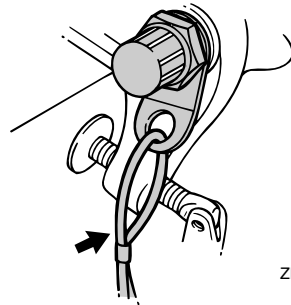

ZMU02013

3. Secure the clamp bracket to the transom using the bolts provided with the outboard (if packed). For details, consult your Yamaha dealer. **WARNING! Avoid using bolts, nuts or washers other than those contained in the engine**

packaging. If used, they must be of at least the same quality of material and strength and must be tightened securely. After tightening, test run the engine and check their tightness.

[EWM00652]

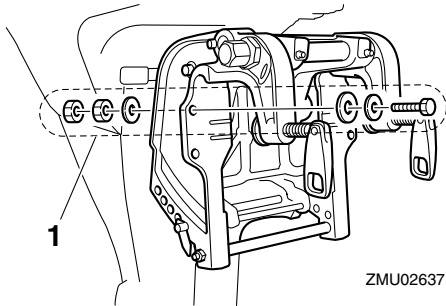

ZMU02637

1. Bolts

Operation

EMU36382

First-time operation

EMU36393

Fill engine oil

The engine is shipped from the factory without engine oil. If your dealer did not fill the oil, you must fill it before starting the engine.

NOTICE: Check that the engine is filled with oil before first-time operation to avoid severe engine damage. [ECM01782]

The engine is shipped with the following tag, which should be removed after engine oil is filled for the first time. For more information on checking the engine oil level, see page 36.

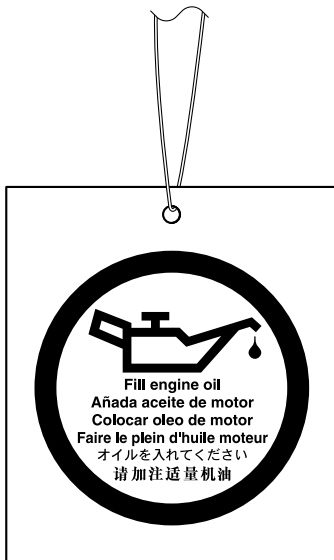

ZMU01710

EMU30175

Breaking in engine

Your new engine requires a period of break-in to allow mating surfaces of moving parts to wear in evenly. Correct break-in will help ensure proper performance and longer engine life. **NOTICE:** Failure to follow the break-in

procedure could result in reduced engine life or even severe engine damage. [ECM00802]

EMU27086

Procedure for 4-stroke models

Your new engine requires a period of 10 hours break-in to allow mating surfaces of moving parts to wear in evenly.

TIP:

Run the engine in the water, under load (in gear with a propeller installed) as follows. For 10 hours for breaking in engine avoid extended idling, rough water and crowded areas.

1. For the first hour of operation:
Run the engine at varying speeds up to 2000 r/min or approximately half throttle.
2. For the second hour of operation:
Increase engine speed as much as necessary to put the boat on plane (but avoid full-throttle operation), then back off on the throttle while keeping the boat at a planing speed.
3. Remaining 8 hours:
Run the engine at any speed. However, avoid operating at full throttle for more than 5 minutes at a time.
4. After the first 10 hours:
Operate the engine normally.

EMU36402

Getting to know your boat

All boats have unique handling characteristics. Operate cautiously while you learn how your boat handles under different conditions and various trim angles (see page 47).

EMU36414

Checks before starting engine

EWM01922



If any item in “Checks before starting engine” is not working properly, have it inspected and repaired before operating the outboard motor. Otherwise, an acci-

dent could occur.

ECM00121

NOTICE

Do not start the engine out of water. Overheating and serious engine damage can occur.

EMU36561

Fuel level

Be sure you have plenty of fuel for your trip. A good rule is to use 1/3 of your fuel to get to the destination, 1/3 to return, and to keep 1/3 as an emergency reserve. With the boat level on a trailer or in the water, check the fuel level. For fuel filling instructions, see page 38.

EMU36573

Remove the top cowling

For the following checks, remove the top cowling from the bottom cowling. To remove the top cowling, release the cowling lock lever and lift off the top cowling.

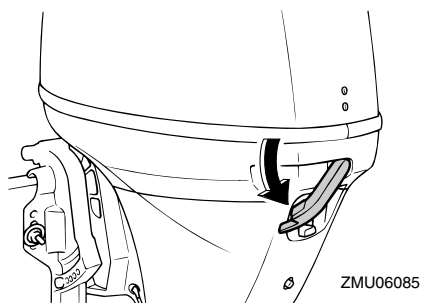

EMU36443

Fuel system

EWMO0061

WARNING

Gasoline and its vapors are highly flammable and explosive. Keep away from sparks, cigarettes, flames, or other sources of ignition.

EWMO0911

WARNING

Leaking fuel can result in fire or explosion.

- Check for fuel leakage regularly.
- If any fuel leakage is found, the fuel system must be repaired by a qualified mechanic. Improper repairs can make the outboard unsafe to operate.

EMU36452

Check for fuel leaks

- Check for fuel leaks or gasoline fumes in the boat.
- Check for fuel leakage from the fuel system.
- Check the fuel tank and fuel lines for cracks, swellings, or other damages.

EMU37323

Checking the fuel filter

Check that the fuel filter is clean and free of water. If any water is found in the fuel, or if a significant amount of debris is found, the fuel tank should be checked and cleaned by a Yamaha dealer.

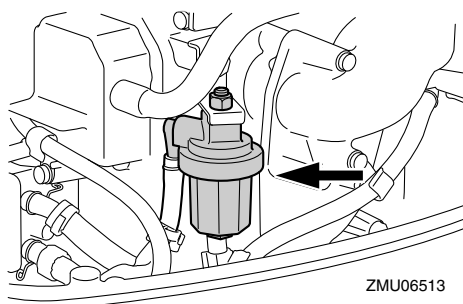

EMU38901

Controls

Tiller handle models:

- Move the tiller handle fully to the left and right to make sure operation is smooth.
- Turn the throttle grip from the fully closed to the fully open position. Make sure that it

Operation

turns smoothly and that it completely returns to the fully closed position.

- Look for loose or damaged connections of the throttle cable and shift link.

Remote control models:

- Turn the steering wheel full-right and full-left. Make sure operation is smooth and unrestricted throughout the whole range with no binding or excessive free play.
- Operate the throttle levers several times to make sure there is no hesitation in their travel. Operation should be smooth over the complete range of motion, and each lever should return completely to the idle position.
- Look for loose or damaged connections of the throttle and shift cables.

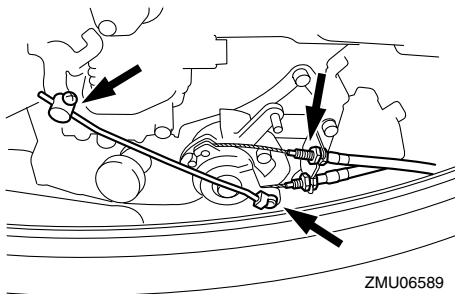
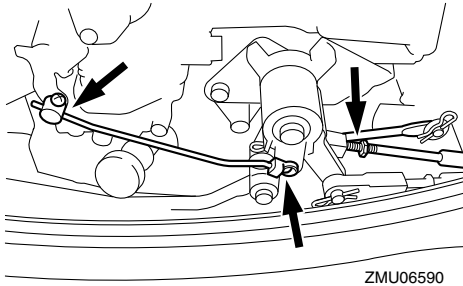

EMU36484

Engine shut-off cord (lanyard)

Inspect the engine shut-off cord and clip for damage, such as cuts, breaks, and wear.

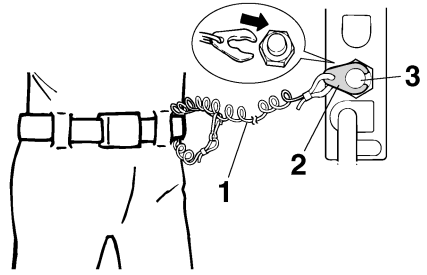

1. Cord
2. Clip
3. Engine shut-off switch

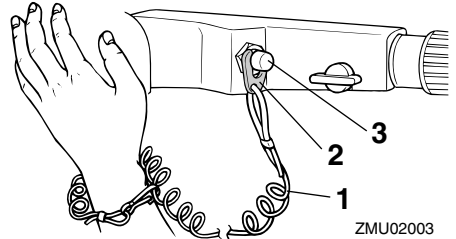

1. Cord
2. Clip
3. Engine shut-off switch

EMU40994

Engine oil

1. Place the outboard motor in a vertical position (not tilted). **NOTICE: If the outboard motor is not level, the oil level indicated on the oil dipstick may not be accurate.** [ECM01862]
2. Remove the oil dipstick and wipe it clean.

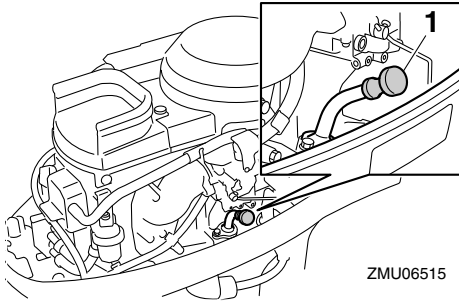

1. Oil dipstick
3. Insert the oil dipstick completely and remove it again.
4. Check that the oil level on the oil dipstick is between the upper and lower marks. Consult your Yamaha dealer if the oil level is not at the proper level or if it appears milky or dirty.

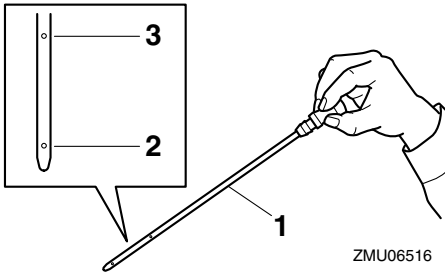

1. Oil dipstick
2. Lower mark
3. Upper mark

EMU27154

Engine

- Check the engine and engine mounting.
- Look for loose or damaged fasteners.
- Check the propeller for damage.
- Check for engine oil leaks.

EMU36494

Flushing device

Check that the flushing device's garden hose

connector is securely screwed on to the fitting on the bottom cowling. **NOTICE:** If the garden hose connector is not properly connected, cooling water can leak out and the engine can overheat during operation. [ECM01802]

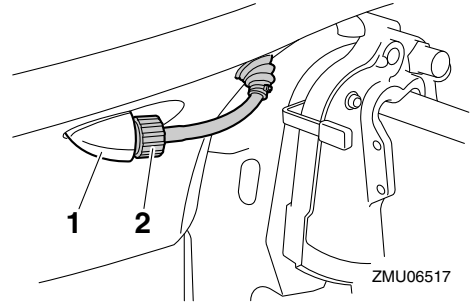

1. Fitting
2. Flushing device

EMU36956

Install top cowling

1. Be sure that the cowling lock lever is released.
2. Be sure that the rubber seal is seated all the way around the top cowling.
3. Place the top cowling on the bottom cowling.
4. Check to be sure the rubber seal is seated correctly between the top cowling and the bottom cowling.
5. Move the cowling lock lever to lock the top cowling as shown. **NOTICE:** If the top cowling is not installed correctly, water spray under the top cowling can damage the engine, or the top cowling can blow off at high speeds.

[ECM01992]

Operation

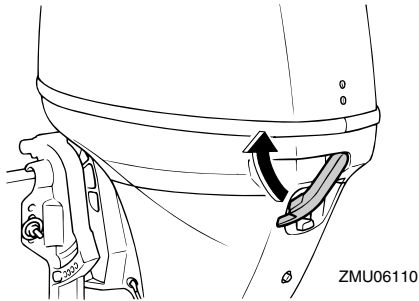

After installing, check the fitting of the top cowling by pushing it with both hands. If the top cowling is loose, have it repaired by your Yamaha dealer.

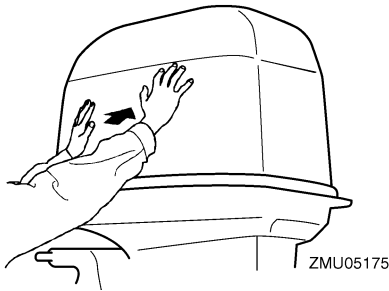

EMU38911

Checking power trim and tilt system

EWM01971

WARNING

- Never get under the lower unit while it is tilted, even when the tilt support knob is locked. Severe injury could occur if the outboard motor accidentally falls.
- Body parts can be crushed between the motor and the clamp bracket when the motor is trimmed or tilted.
- Be sure no one is near the outboard motor before performing this check.

1. Check the power trim and tilt unit for any sign of oil leaks.

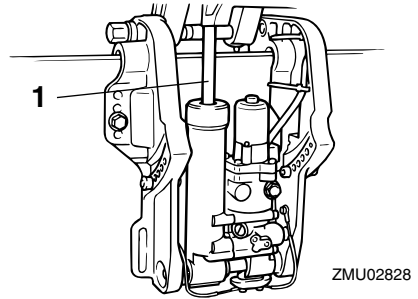

1. Trim and tilt rod
2. Operate each of the power trim and tilt switches to check that all switches work.
3. Tilt the outboard motor up and check that the trim and tilt rod is pushed out completely.
4. Check that the trim and tilt rod is free of corrosion or other flaws.
5. Tilt the outboard motor down. Check that the trim and tilt rod operates smoothly.

EMU36583

Battery

Check that the battery is in good condition, and fully charged. Check that the battery connections are clean, secure and covered by insulating covers. The electrical contacts of the battery and cables must be clean and properly connected or the battery will not start the engine.

Refer to the battery manufacturer's instructions for checks for your particular battery.

EMU2743A

Filling fuel

EWM01831

WARNING

- Gasoline and its vapors are highly flammable and explosive. Always refuel according to this procedure to reduce the risk of fire and explosion.
- Gasoline is poisonous and can cause

injury or death. Handle gasoline with care. Never siphon gasoline by mouth. If you should swallow some gasoline or inhale a lot of gasoline vapor, or get some gasoline in your eyes, see your doctor immediately. If gasoline spills on your skin, wash with soap and water. If gasoline spills on your clothing, change your clothes.

1. Be sure the engine is stopped.
2. Disconnect the fuel line from the fuel tank and tighten the air vent screw on the fuel tank cap.

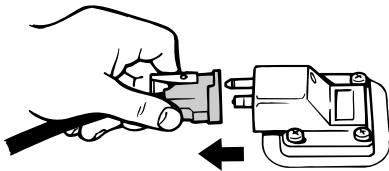

ZMU06598

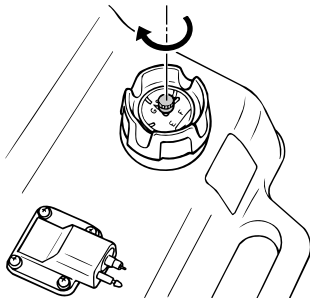

ZMU04058

3. Remove the portable tank from the boat.
4. Be sure you are in a well-ventilated outdoor area, either securely moored or trailered.
5. Do not smoke and keep away from sparks, flames, static electric discharge, or other sources of ignition.

6. If you use a portable container to store and dispense fuel, use only an approved GASOLINE container.
7. Touch the fuel nozzle to the filler opening or funnel to help prevent electrostatic sparks.
8. Fill the fuel tank, but do not overfill. **WARNING! Do not overfill. Otherwise fuel can expand and overflow if the temperature increases.** [EWM02611]

Fuel tank capacity:
25 L (6.60 US gal, 5.50 Imp.gal)

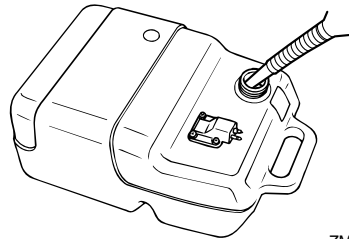

ZMU04047

9. Tighten the filler cap securely.
10. Wipe up any spilled gasoline immediately with dry rags. Dispose rags properly according to local laws or regulations.

EMU27453

Operating engine

EWM00421

WARNING

- Before starting the engine, make sure that the boat is tightly moored and that you can steer clear of any obstructions. Be sure there are no swimmers in the water near you.
- When the air vent screw is loosened, gasoline vapor will be released. Gasoline is highly flammable, and its vapors are flammable and explosive. Refrain from smoking, and keep away from

Operation

open flames and sparks while loosening the air vent screw.

- This product emits exhaust gases which contain carbon monoxide, a colorless, odorless gas which could cause brain damage or death when inhaled. Symptoms include nausea, dizziness, and drowsiness. Keep cockpit and cabin areas well ventilated. Avoid blocking exhaust outlets.

EMU27469

Sending fuel (portable tank)

1. If there is an air vent screw on the fuel tank cap, loosen it 2 or 3 turns.

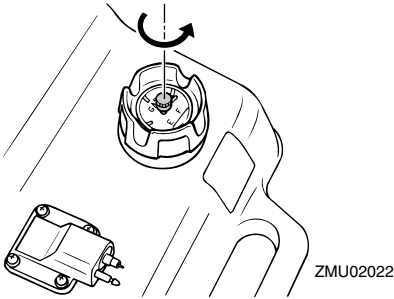

2. If there is a fuel joint on the motor, align the fuel joint on the fuel line with the fuel joint on the motor and firmly connect the fuel line to the joint while pinching the joint. Then firmly connect the other end of the fuel line to the joint on the fuel tank.

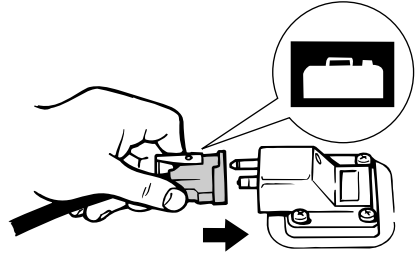
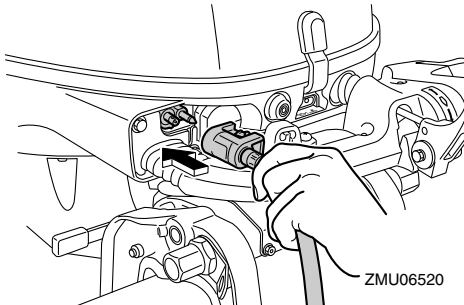

ZMU02024

TIP:

Wipe up any spilled gasoline immediately with dry rags. Dispose rags properly according to local laws or regulations.

3. Squeeze the primer pump, with the arrow pointing up, until you feel it become firm. During engine operation place the tank horizontally, otherwise fuel cannot be drawn from the fuel tank.

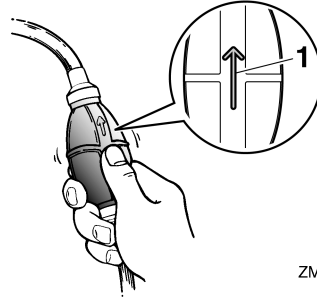

ZMU02025

1. Arrow

EMU27495

Starting engine

EWM01601

WARNING

Before starting the engine, make sure that the boat is tightly moored and that you can steer clear of any obstructions. Be sure there are no swimmers in the water near you.

EMU39013

Manual start/prime start models

EWM01841

WARNING

- Failure to attached engine shut-off cord could result in a runaway boat if operator is ejected. Attach the engine shut-off cord to a secure place on your clothing, or your arm or leg while operating. Do not attach the cord to clothing that could tear loose. Do not route the cord where it could become entangled, preventing it from functioning.
- Avoid accidentally pulling the cord during normal operation. Loss of engine power means the loss of most steering control. Also, without engine power, the boat could slow rapidly. This could cause people and objects in the boat to be thrown forward.

Starting procedure (cold engine)

1. Place the gear shift lever in neutral.

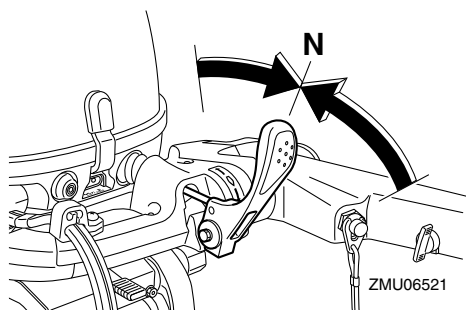

TIP:

The start-in-gear protection device prevents the engine from starting except when in neutral.

2. Attach the engine shut-off cord to a secure place on your clothing, or your arm or leg. Then install the clip on the other end of the cord into the engine shut-off switch.

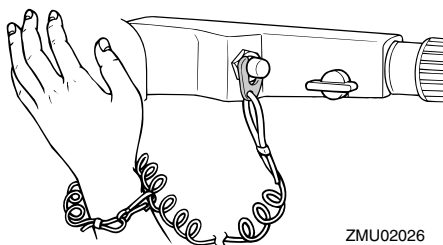

3. Place the throttle grip in the "START" (start) position.

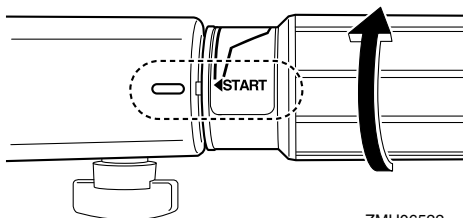

4. Pull the manual starter handle slowly until you feel resistance. Then give a strong pull straight out to crank and start the engine. Repeat if necessary.

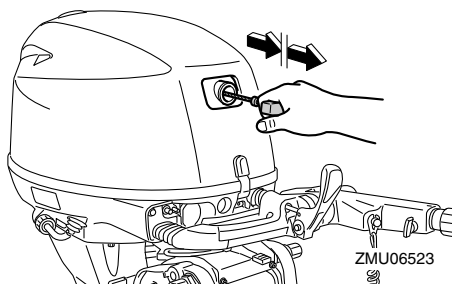

5. After the engine starts, slowly return the manual starter handle to its original position before releasing it.

TIP:

When the engine is cold, it needs to be

Operation

warmed up. For further information, see page 44.

6. Slowly return the throttle grip to the fully closed position.

Starting procedure (warm engine)

1. Place the gear shift lever in neutral.

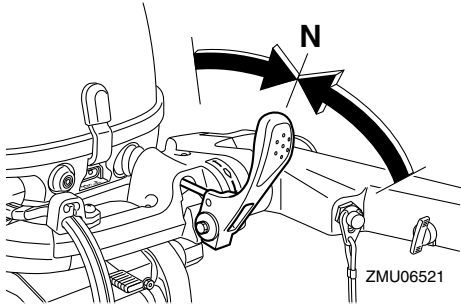

TIP:

The start-in-gear protection device prevents the engine from starting except when in neutral.

2. Attach the engine shut-off cord to a secure place on your clothing, or your arm or leg. Then install the clip on the other end of the cord into the engine shut-off switch.

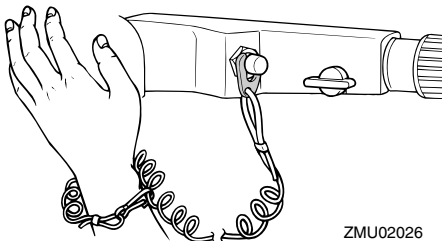

3. Open the throttle grip as shown in the illustration.

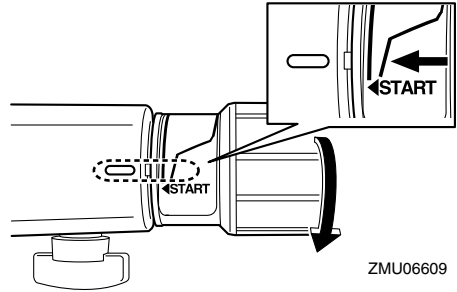

TIP:

- If the throttle is opened too much, the engine speed rises rapidly, causing the out-board motor to swivel toward the starboard side.
- Do not repeat opening and closing of the throttle grip as this causes the spark plug to wet with fuel and prevent the engine from starting.

4. Hold this throttle grip position by tightening the throttle friction adjuster.

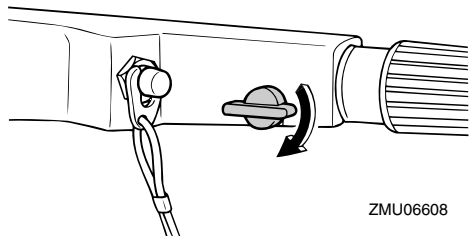

5. Pull the manual starter handle slowly until you feel resistance. Then give a strong pull straight out to crank and start the engine. Repeat if necessary.

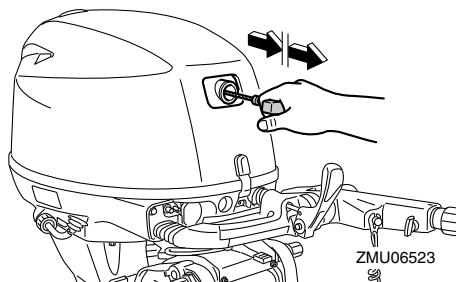

6. After the engine starts, slowly return the manual starter handle to its original position before releasing it.
7. Loosen the throttle friction adjuster and return the throttle to the fully closed position. **WARNING! Loosen the throttle friction adjuster. If there is too much resistance, it could be difficult to move the throttle grip, which could result in an accident.** [EWM02251]

EMU27665

Electric start and remote control models

EWM01841

! WARNING

- Failure to attached engine shut-off cord could result in a runaway boat if operator is ejected. Attach the engine shut-off cord to a secure place on your clothing, or your arm or leg while operating. Do not attach the cord to clothing that could tear loose. Do not route the cord where it could become entangled, preventing it from functioning.
- Avoid accidentally pulling the cord during normal operation. Loss of engine power means the loss of most steering control. Also, without engine power, the boat could slow rapidly. This could cause people and objects in the boat to be thrown forward.

1. Place the remote control lever in neutral.

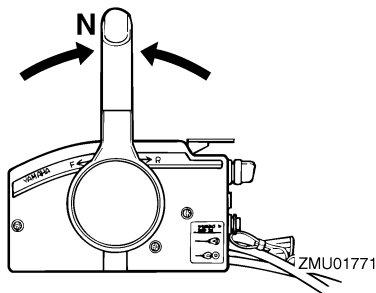

TIP:

The start-in-gear protection device prevents the engine from starting except when in neutral.

2. Attach the engine shut-off cord to a secure place on your clothing, or your arm or leg. Then install the clip on the other end of the cord into the engine shut-off switch.

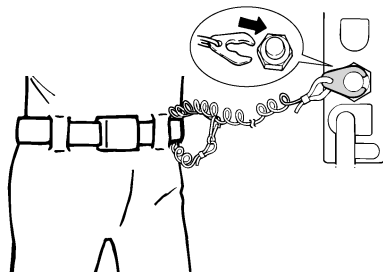

ZMU01772

3. Turn the main switch to "ON" (on).
4. Turn the main switch to "START" (start), and hold it for a maximum of 5 seconds.

Operation

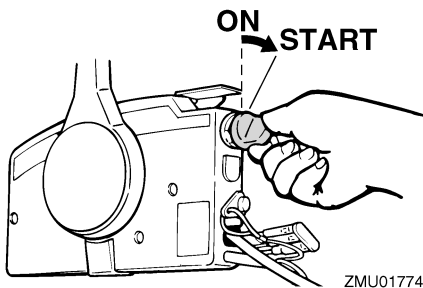

ZMU01774

5. Immediately after the engine starts, release the main switch and allow it to return to "ON" (on). **NOTICE:** Never turn the main switch to "START" (start) while the engine is running. Do not keep the starter motor turning for more than 5 seconds. If the starter motor is turned continuously for more than 5 seconds, the battery will be quickly discharged, thus making it impossible to start the engine. The starter can also be damaged. If the engine will not start after 5 seconds of cranking, return the main switch to "ON" (on), wait 10 seconds, then crank the engine again. [ECM00193]

TIP:

- When the engine is cold, it needs to be warmed up. For further information, see page 44.
- If the engine is warm and fails to start, open the throttle slightly and try to start the engine again. If the engine still fails to start, see page 77.

EMU36511

Checks after starting engine

EMU36524

Cooling water

Check for a steady flow of water from the cooling water pilot hole. A continuous flow of water from the pilot hole indicates that the

water pump is pumping water through the cooling water passages. If the cooling water passages are frozen, it may take a while for water to start flowing out of the pilot hole.

ECM01811

NOTICE

If water is not flowing out of the pilot hole at all times while the engine is running, overheating and serious damage could occur. Stop the engine and check whether the cooling water inlet on the lower case or the cooling water pilot hole is blocked. Consult your Yamaha dealer if the problem cannot be located and corrected.

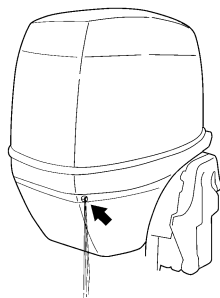

ZMU05168

EMU27671

Warming up engine

EMU27717

Manual start and electric start models

1. After starting the engine, allow it to idle for 3 minutes to warm up. Failure to do so will shorten engine life.
2. Be sure the low oil pressure-alert indicator goes off after starting the engine. **NOTICE:** If the low oil pressure-alert indicator blinks after the engine starts, stop the engine. Otherwise, serious engine damage could occur. Check the oil level and add engine oil

if necessary. Consult your Yamaha dealer if the cause for the low oil pressure alert cannot be found.

[ECM01832]

EMU36532

Checks after engine warm up

EMU36542

Shifting

While the boat is tightly moored, and without applying throttle, confirm that the engine shifts smoothly into forward and reverse, and back to neutral.

EMU36981

Stop switches

- Turn the main switch to "OFF", or press the engine stop button and make sure the engine stops.
- Confirm that removing the clip from the engine shut-off switch stops the engine.
- Confirm that the engine cannot be started with the clip removed from the engine shut-off switch.

EMU34563

Shifting

EWM00181

WARNING

Before shifting, make sure there are no swimmers or obstacles in the water near you.

ECM01611

NOTICE

Warm up the engine before shifting into gear. Until the engine is warm, the idle speed may be higher than normal. High idle speed can prevent you from shifting back to neutral. If this occurs, stop the engine, shift to neutral, then restart the engine and allow it to warm up.

To shift out of neutral

1. Pull the neutral interlock trigger up (if equipped).

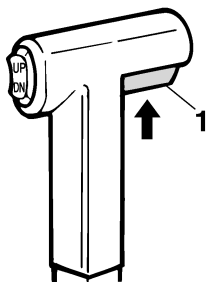

ZMU01727

1. Neutral interlock trigger

2. Move the remote control lever / gear shift lever firmly and crisply forward (for forward gear) or backward (for reverse gear) [about 35° (a detent can be felt) for remote control models]. Be sure to check that the tilt lock lever is in the lock/down position (if equipped) before operating in reverse.

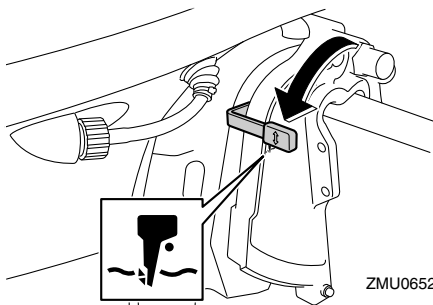

ZMU06528

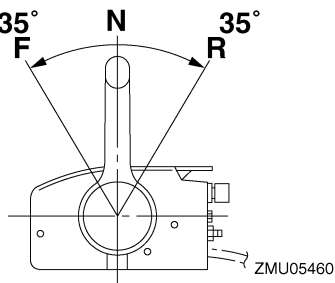

ZMU05460

Operation

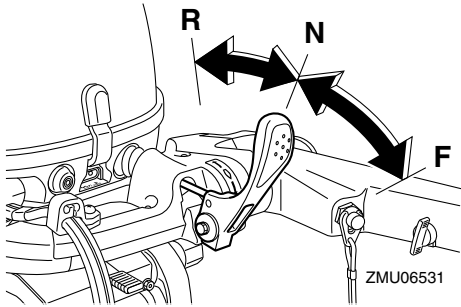

TIP:

Tiller handle models: The gear shift lever operates only when the throttle grip is in the fully closed position.

To shift from in gear (forward/reverse) to neutral

1. Close the throttle so that the engine slows to idle speed.

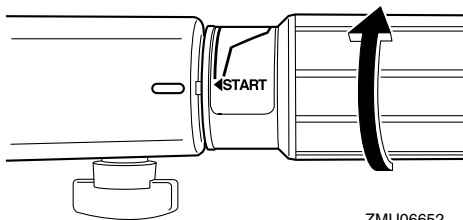
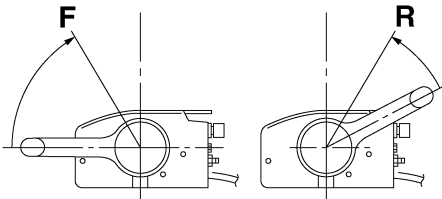

2. After the engine is at idle speed in gear move the remote control lever / gear shift lever firmly and crisply into the neu-

tral position.

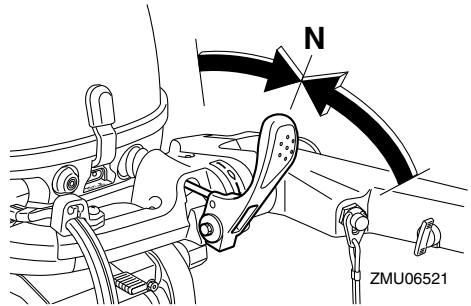
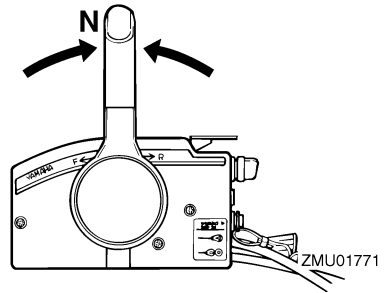

EMU31743

Stopping boat

EWM01511

WARNING

- Do not use the reverse function to slow down or stop the boat as it could cause you to lose control, be ejected, or impact the steering wheel or other parts of the boat. This could increase the risk of serious injury. It could also damage the shift mechanism.
- Do not shift into reverse while traveling at planing speeds. Loss of control, boat swamping, or damage to the boat could occur.

The boat is not equipped with a separate braking system. Water resistance stops it after the throttle lever is moved back to idle. The stopping distance varies depending on gross weight, water surface conditions, and

wind direction.

EMU27822

Stopping engine

Before stopping the engine, first let it cool off for a few minutes at idle or low speed. Stopping the engine immediately after operating at high speed is not recommended.

EMU27848

Procedure

1. Push and hold the engine stop button or turn the main switch to "OFF" (off).

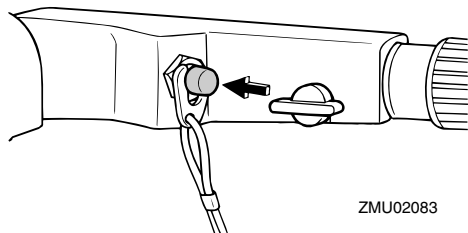

ZMU02083

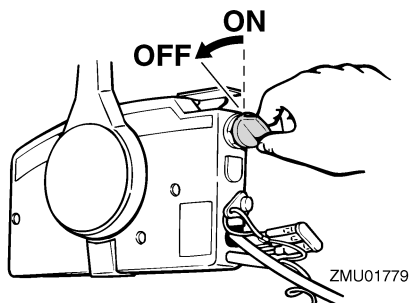

ZMU01779

2. After stopping the engine, disconnect the fuel line if there is a fuel joint on the outboard motor.

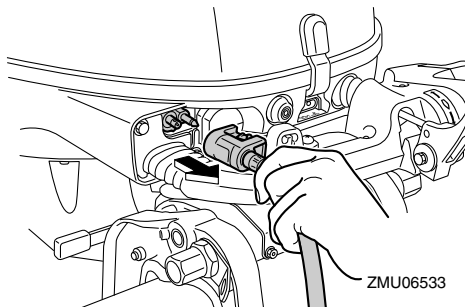

ZMU06533

3. Tighten the air vent screw on the fuel tank cap (if equipped).

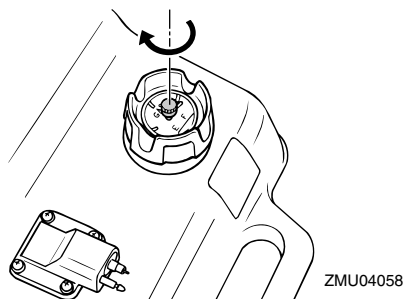

ZMU04058

4. Remove the key if the boat will be left unattended.

TIP:

The engine can also be stopped by pulling the cord and removing the clip from the engine shut-off switch, then turning the main switch to "OFF" (off).

EMU27863

Trimming outboard motor

EWM00741



WARNING

Excessive trim for the operating conditions (either trim up or trim down) can cause boat instability and can make steering the boat more difficult. This increases the possibility of an accident. If the boat begins to feel unstable or is hard to steer, slow down and/or readjust the

Operation

trim angle.

The trim angle of the outboard motor helps determine the position of the bow of the boat in the water. Correct trim angle will help improve performance and fuel economy while reducing strain on the engine. Correct trim angle depends upon the combination of boat, engine, and propeller. Correct trim is also affected by variables such as the load in the boat, sea conditions, and running speed.

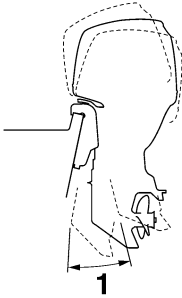

ZMU05170

1. Trim operating angle

EMU38881

Adjusting trim angle for manual tilt models

EWM00401

WARNING

- Stop the engine before adjusting the trim angle.
- Use care to avoid being pinched when removing or installing the rod.
- Use caution when trying a trim position for the first time. Increase speed gradually and watch for any signs of instability or control problems. Improper trim angle can cause loss of control.

There are 4 or 5 holes provided in the clamp bracket to adjust the outboard motor trim angle.

1. Stop the engine.

2. Tilt the outboard motor up and remove the trim rod by pressing clip.

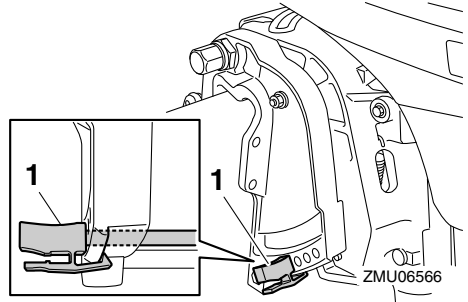

ZMU06566

1. Trim rod

3. Reposition the rod in the desired hole. To raise the bow ("trim-out"), move the rod away from the transom.

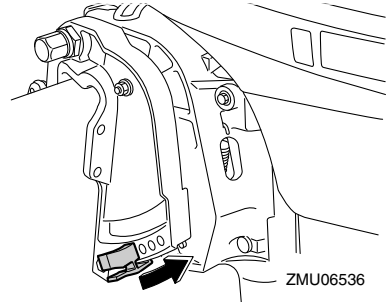

ZMU06536

- To lower the bow ("trim-in"), move the rod toward the transom.

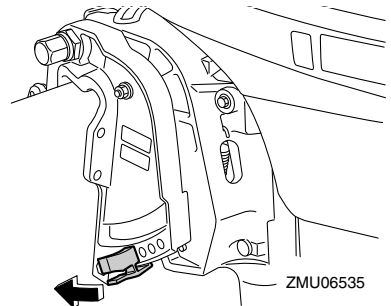

ZMU06535

Make test runs with the trim set to different angles to find the position that works best for

your boat and operating conditions.

TIP:

The outboard motor trim angle can be changed approximately 4 degrees by shifting the trim rod one hole.

EMU27889

Adjusting trim angle (Power trim and tilt)

EWM00754

WARNING

- Be sure all people are clear of the outboard motor when adjusting the trim angle. Body parts can be crushed between the motor and the clamp bracket when the motor is trimmed or tilted.
- Use caution when trying a trim position for the first time. Increase speed gradually and watch for any signs of instability or control problems. Improper trim angle can cause loss of control.
- If equipped with a power trim and tilt switch located on the bottom cowling, use the switch only when the boat is at a complete stop with the engine off. Do not adjust the trim angle with this switch while the boat is moving.

Adjust the outboard motor trim angle using the power trim and tilt switch.

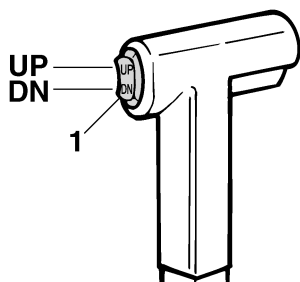

ZMU01781

1. Power trim and tilt switch

To raise the bow (trim-out), press the switch

“UP” (up).

To lower the bow (trim-in), press the switch “DN” (down).

Make test runs with the trim set to different angles to find the position that works best for your boat and operating conditions.

EMU27913

Adjusting boat trim

When the boat is on plane, a bow-up attitude results in less drag, greater stability and efficiency. This is generally when the keel line of the boat is up about 3 to 5 degrees. With the bow up, the boat may have a greater tendency to steer to one side or the other. Compensate for this as you steer. When the bow of the boat is down, it is easier to accelerate from a standing start onto plane.

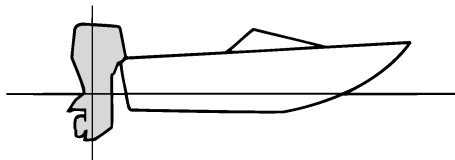

ZMU01784

Bow Up

Too much trim-out puts the bow of the boat too high in the water. Performance and economy are decreased because the hull of the boat is pushing the water and there is more air drag. Excessive trim-out can also cause the propeller to ventilate, which reduces performance further, and the boat may “porpoise” (hop in the water), which could throw the operator and passengers overboard.

Operation

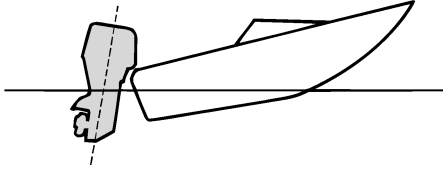

ZMU01785

Bow Down

Too much trim-in causes the boat to “plow” through the water, decreasing fuel economy and making it hard to increase speed. Operating with excessive trim-in at higher speeds also makes the boat unstable. Resistance at the bow is greatly increased, heightening the danger of “bow steering” and making operation difficult and dangerous.

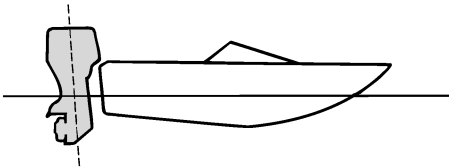

ZMU01786

TIP:

Depending on the type of boat, the outboard motor trim angle may have little effect on the trim of the boat when operating.

EMU27936

Tilting up and down

If the engine will be stopped for some time or if the boat is moored in shallows, the outboard motor should be tilted up to protect the propeller and lower casing from damage by collision with obstructions, and also to reduce salt corrosion.

EWM00223

WARNING

Make sure that no one is near the outboard motor when tilting the outboard motor up or down. Otherwise, body parts could be crushed between the outboard motor and the clamp bracket.

EWM00251

WARNING

Leaking fuel is a fire hazard. If there is a fuel joint on the outboard motor, disconnect the fuel line or close the fuel cock if the engine will be tilted for more than a few minutes. Otherwise fuel may leak.

ECM00242

NOTICE

- Before tilting the outboard motor, stop the engine by following the procedure on page 47. Never tilt the outboard motor while the engine is running. Severe damage from overheating can result.
- Do not tilt up the engine by pushing the tiller handle (if equipped) because this could break the handle.

EMU2797C

Procedure for tilting up (manual tilt models)

1. Place the remote control lever / gear shift lever in neutral.

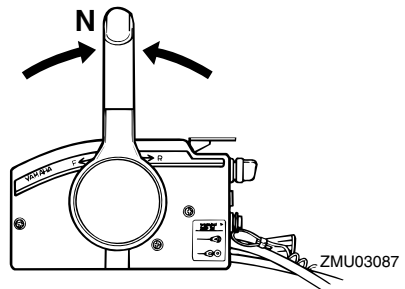

ZMU03087

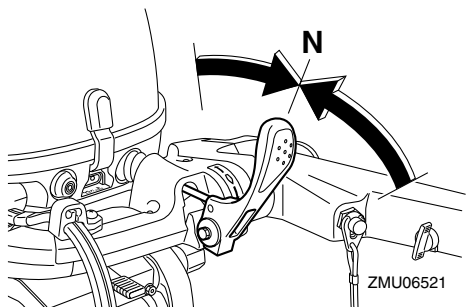

2. Disconnect the fuel line from the outboard motor.

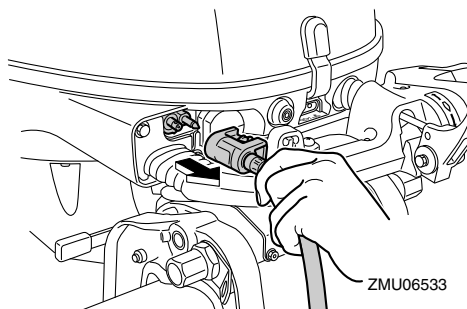

3. Place the tilt lock lever (if equipped) in the release/up position.

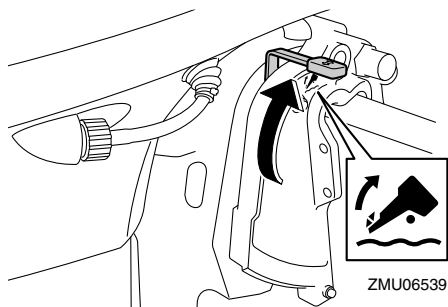

4. Pull up the shallow water lever (if equipped).
5. Hold the rear of the top cowling with one hand and tilt the engine up fully.
6. Push the tilt support knob into the clamp bracket. Or the tilt support bar will turn to the lock position automatically.

NOTICE: Do not use the tilt support lever or knob when trailering the boat. The outboard motor could shake loose from the tilt support and fall. If the motor cannot be trailered in the normal running position, use an additional support device to secure it in the tilt position. For more detailed information, see page 56. [ECM01642]

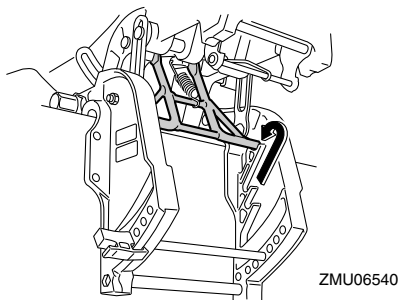

EMU44660

Procedure for tilting up (power trim and tilt models)

1. Place the remote control lever in neutral.

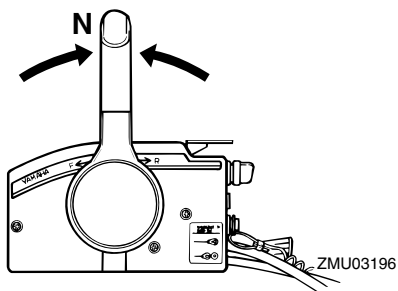

2. Press the power trim and tilt switch "UP" (up) until the outboard motor has tilted up completely.

Operation

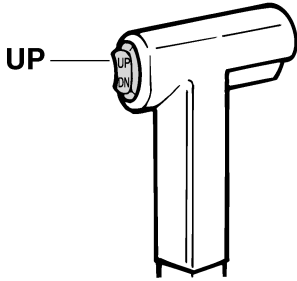

ZMU01787

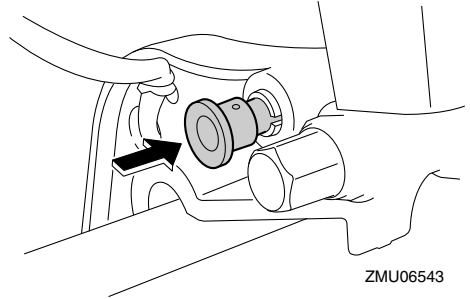

ZMU06543

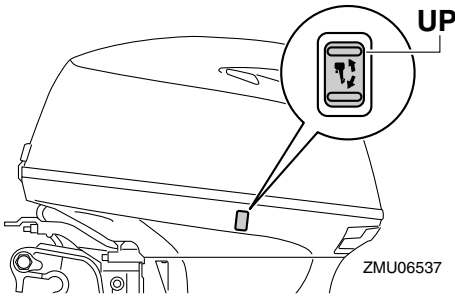

ZMU06537

3. Push the tilt support knob into the clamp bracket to support the engine. **WARNING!** After tilting the outboard motor, be sure to support it with the tilt support knob or tilt support lever. Otherwise the outboard motor could fall back down suddenly if oil in the power trim and tilt unit or in the power tilt unit loses pressure. [EWM00263] **NOTICE:** Do not use the tilt support lever or knob when trailering the boat. The outboard motor could shake loose from the tilt support and fall. If the motor cannot be trailered in the normal running position, use an additional support device to secure it in the tilt position. For more detailed information, see page 56. [ECM01642]

EMU30193

Procedure for tilting down (manual tilt models)

1. Place the tilt lock lever in the lock position.

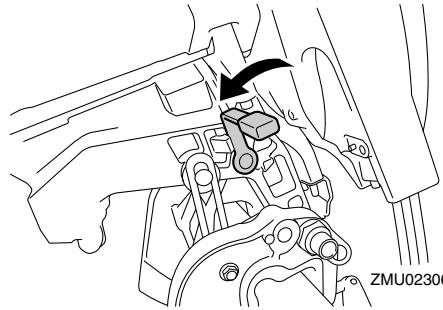

ZMU02306

2. Slightly tilt the engine up until the tilt support bar is automatically released.
3. Slowly tilt the engine down.

EMU44601

Procedure for tilting down (power trim and tilt models)

1. Push the power trim and tilt switch "UP" (up) until the outboard motor is supported by the tilt rod and the tilt support knob becomes free.
2. Pull out the tilt support knob.

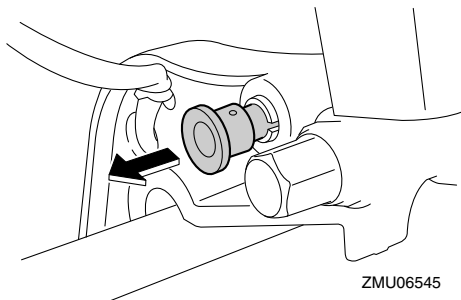

3. Push the power trim and tilt switch “DN” (down) to lower the outboard motor to the desired position.

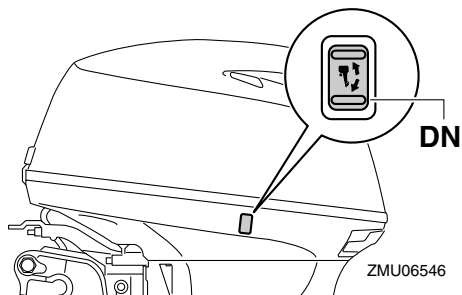
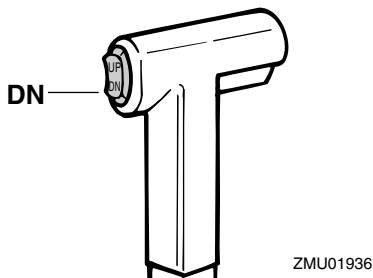

EMU28063

Shallow water

EMU28074

Cruising in shallow water (manual tilt models)

EWM01782



- Run the boat at the lowest possible

speed when using the shallow water cruising system. The tilt lock mechanism does not work while the shallow water cruising system is being used. Hitting an underwater obstacle could cause the outboard motor to lift out of the water, resulting in loss of control.

- Use extra care when operating in reverse. Too much reverse thrust can cause the outboard motor to lift out of the water, increasing the chance of accident and personal injury.

ECM00261

NOTICE

Do not tilt the outboard motor up so that the cooling water inlet on the lower unit is above the surface of the water when setting up for and cruising in shallow water. Otherwise severe damage from overheating can result.

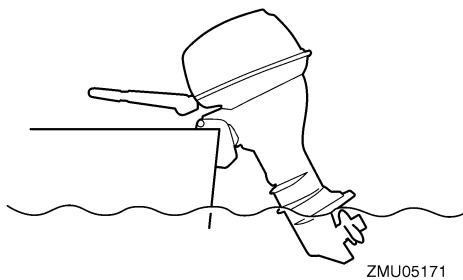

EMU28126

Procedure

1. Place the remote control lever / gear shift lever in neutral.

Operation

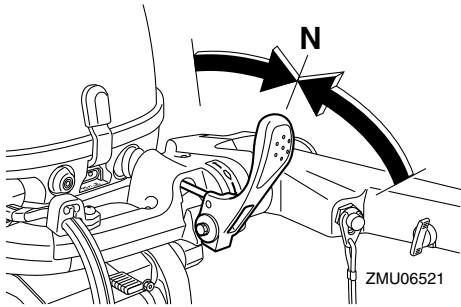
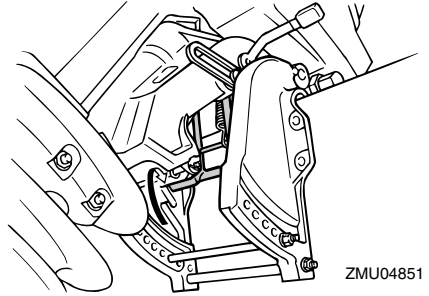
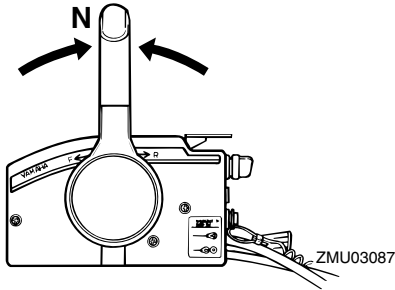

2. Place the tilt lock lever in the release/up position.

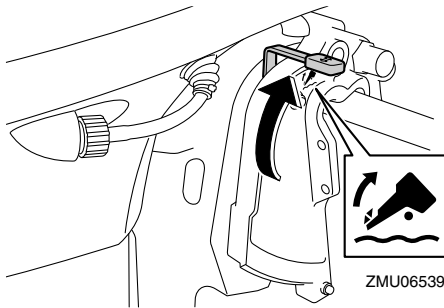

3. Slightly tilt the outboard motor up. The tilt support bar will lock automatically, supporting the outboard motor in a partially raised position. This outboard motor has 2 positions for shallow water cruising.

4. To return the outboard motor to the normal running position, place the remote control lever / gear shift lever in neutral.
5. Place the tilt lock lever in the lock/down position, then slightly tilt the outboard motor up until the tilt support bar automatically returns to the free position.

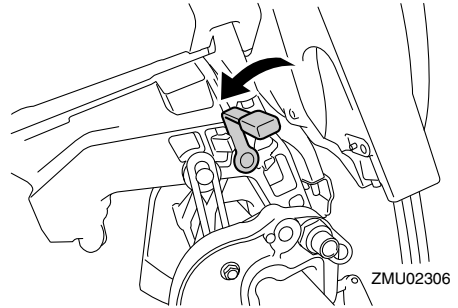

6. Slowly lower the outboard motor to the normal position.

EMU32852

Power trim and tilt models

The outboard motor can be tilted up partially to allow operation in shallow water.

ECM00261

NOTICE

Do not tilt the outboard motor up so that the cooling water inlet on the lower unit is above the surface of the water when setting up for and cruising in shallow water. Otherwise severe damage from overheating can result.

EMU32923

Procedure for power trim and tilt models

1. Place the remote control lever in neutral.

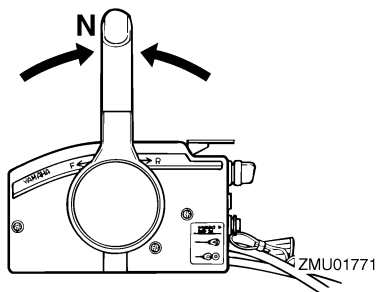

2. Slightly tilt the outboard motor up to the desired position using the power trim and tilt switch. **WARNING! Using the power trim and tilt switch on the bottom cowling while the boat is moving or engine is on could increase the risk of falling overboard and could distract the operator, increasing the risk of collision with another boat or an obstacle.** [EWM01851]

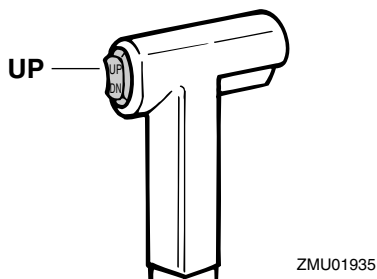

3. To return the outboard motor to the normal running position, press the power trim and tilt switch and slowly tilt the outboard motor down.

EMU28196

Cruising in other conditions

Cruising in salt water

After operating in salt water, flush the cooling

water passages with fresh water to prevent them from becoming clogged. Also rinse the outside of the outboard motor with fresh water.

Cruising in muddy, turbid, or acidic water

Yamaha strongly recommends that you use the optional chromium-plated water pump kit (see page 15) if you use the outboard motor in acidic water or water with a lot of sediment in it, such as muddy or turbid (cloudy) water. After operating in such water, flush the cooling passages with fresh water to prevent corrosion. Also rinse the outside of the outboard motor with fresh water.

Maintenance

EMU2822B

Transporting and storing outboard motor

EWM02621

WARNING

- **USE CARE** when transporting fuel tank, whether in a boat or car.
- **DO NOT** fill fuel container to maximum capacity. Gasoline will expand considerably as it warms up and can build up pressure in the fuel container. This can cause fuel leakage and a potential fire hazard.
- **Leaking fuel is a fire hazard. When transporting and storing the outboard motor, disconnect the fuel line from the outboard motor to prevent fuel from leaking.**
- **Never get under the outboard motor while it is tilted. Severe injury could occur if the outboard motor accidentally falls.**
- **Do not use the tilt support lever or knob when trailering the boat. The outboard motor could shake loose from the tilt support and fall. If the outboard motor cannot be trailered in the normal running position, use an additional support device to secure it in the tilt position.**

ECM02441

NOTICE

When storing the outboard motor for prolonged time, fuel must be drained from the fuel tank. The deteriorated fuel could clog the fuel line causing engine start difficulty or malfunction.

When storing or transporting the outboard motor, make sure to follow the procedure listed below.

- Disconnect the fuel line from the outboard motor.
- Tighten the fuel tank cap and its air vent screw.
- When the outboard motor is tilted prolonged time for mooring or trailering the boat, disconnect the fuel line from the outboard motor. Tighten the fuel tank cap and its air vent screw.

The outboard motor should be transported and stored in the normal running position. If there is insufficient road clearance in this position, then trailer the outboard motor in the tilt position using a motor support device such as a transom saver bar. Consult your Yamaha dealer for further details.

EMU28237

Clamp screw mounting models

When transporting or storing the outboard motor while removed from a boat, keep the outboard motor in the attitude shown.

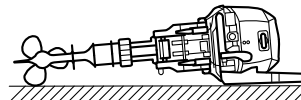
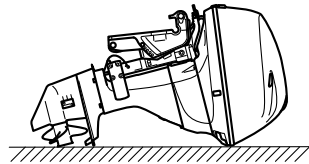
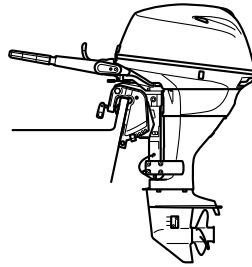

ZMU06560

TIP:

Place a towel or something similar under the outboard motor to protect it from damage.

EMU28242

Storing outboard motor

When storing your Yamaha outboard motor for prolonged periods of time (2 months or longer), several important procedures must be performed to prevent excessive damage. It is advisable to have your outboard motor serviced by an authorized Yamaha dealer prior to storage. However, you, the owner, with a minimum of tools, can perform the following procedures.

ECM01081

NOTICE

- To prevent problems which can be caused by oil entering the cylinder from the sump, keep the outboard motor in the attitude shown when transporting and storing it. If storing or transporting the outboard motor on its side (not upright), put it on a cushion after draining the engine oil.
- Do not place the outboard motor on its side before the cooling water has drained from it completely, otherwise water may enter the cylinder through the exhaust port and cause engine trouble.
- Store the outboard motor in a dry, well-ventilated place, not in direct sunlight.

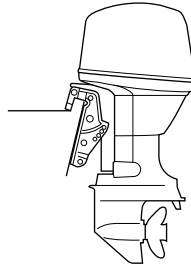

ZMU03659

EMU28306

Procedure

EMU38871

Flushing in a test tank

ECM02131

NOTICE

Do not run the engine without supplying it with cooling water. Either the engine water pump will be damaged or the engine will be damaged from overheating.

Cooling system flushing is essential to prevent the cooling system from clogging up with salt, sand, or dirt. In addition, fogging/lubricating of the engine is mandatory to prevent excessive engine damage due to rust. Perform the flushing and fogging at the same time.

1. Wash the outboard motor body using fresh water. **NOTICE: Do not spray water into the air intake.** [ECM01841] For further information, see page 60.
2. Disconnect the fuel line from the outboard motor.
3. Remove the engine top cowling and propeller. For further details, see page 71.
4. Install the outboard motor on a water tank. Fill the tank with fresh water until the anti-cavitation plate is immersed in water. **NOTICE: If the fresh water level is below the level of the anti-cavitation plate, or if the water supply is in-**

Maintenance

sufficient, engine seizure may occur.

[ECM00292]

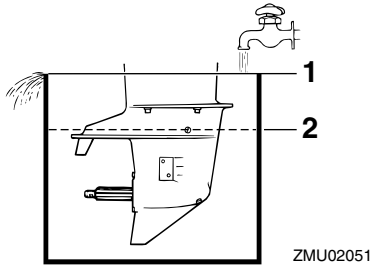

1. Water surface
2. Lowest water level

5. Run the engine at a fast idle for a few minutes in neutral position. **WARNING! Do not touch or remove electrical parts when starting or during operation. Keep hands, hair, and clothes away from the flywheel and other rotating parts while the engine is running.** [EWM00092]
6. Just prior to turning off the engine, quickly spray “Fogging Oil” on to the silencer cover. When properly done, the engine will almost stall.

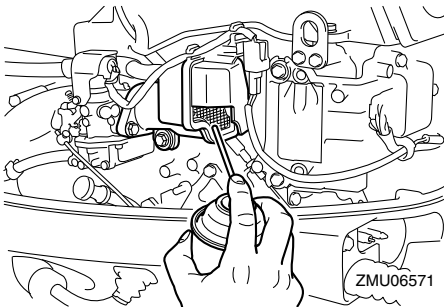

TIP:

If the “Fogging Oil” is not available, run the engine at idle speed until the fuel system becomes empty and the engine stops. Remove

the spark plugs and turn the flywheel magnet several times with starter motor or by pulling the manual starter handle to coat the cylinder wall with oil.

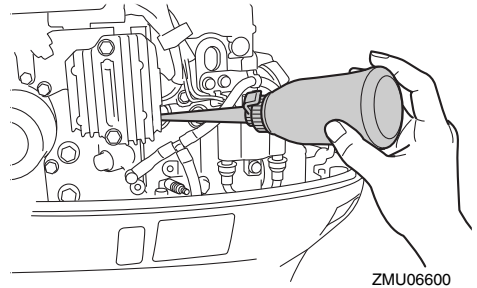
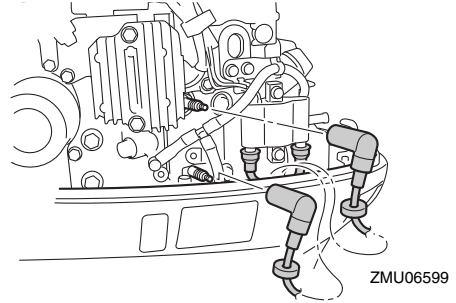

7. Remove the outboard motor from the test tank.
8. Drain the cooling water completely out of the motor. Clean the body thoroughly.
9. Install the top cowling.
10. Store the fuel tank in a dry, well-ventilated place, not in direct sunlight.

EMU28403

Lubrication

1. Install the spark plug(s) and torque to proper specification. For information on spark plug installation, see page 66.
2. Change the gear oil. For instructions, see page 72. Inspect the oil for the presence of water that indicates a leaky seal. Seal replacement should be performed by an authorized Yamaha dealer prior to

use.

- Grease all grease fittings. For further details, see page 65.

TIP:

For long-term storage, fogging the engine with oil is recommended. Contact your Yamaha dealer for information about fogging oil and procedures for your engine.

EMU28446

Flushing power unit

Perform this procedure right after operation for the most thorough flushing.

ECM01531

NOTICE

Do not perform this procedure while the engine is running. The water pump may be damaged and severe damage from overheating can result.

- After shutting off the engine, unscrew the garden hose connector from the fitting on the bottom cowling.

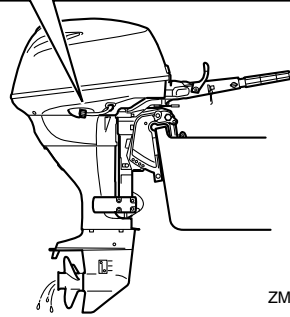
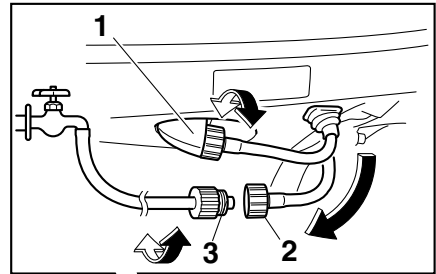

ZMU06553

- Fitting
 - Garden hose connector
 - Garden hose adapter
- Screw the garden hose adapter onto a garden hose, which is connected to a fresh water supply, and then connect it to the garden hose connector.
 - With the engine off, turn on the water tap and let the water flush through the cooling passages for about 15 minutes. Turn off the water and disconnect the garden hose adapter from the garden hose connector.
 - Reinstall the garden hose connector onto the fitting on the bottom cowling. Tighten the connector securely.
NOTICE: Do not leave the garden hose connector loose on the bottom cowling fitting or let the hose hang free during normal operation. Water

Maintenance

will leak out of the connector instead of cooling the engine, which can cause serious overheating. Be sure the connector is tightened securely on the fitting after flushing the engine. [ECM00542]

TIP:

- When flushing the engine with the boat in the water, tilting up the outboard motor until it is completely out of the water will achieve better results.
- For cooling system flushing instructions, see page 56.

EMU44341

Cleaning the outboard motor

When cleaning the outboard motor, the top cowling must be installed.

1. Wash the exterior of the outboard motor using fresh water. **NOTICE: Do not spray water into the air intake.** [ECM01841]

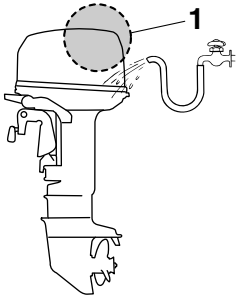

ZMU07873

1. Air intake
2. Drain the cooling water completely out of the outboard motor. Clean the body thoroughly.

EMU28462

Checking painted surface of outboard motor

Check the outboard motor for scratches, nicks, or flaking paint. Areas with damaged paint are more likely to corrode. If necessary,

clean and paint the areas. A touch-up paint is available from your Yamaha dealer.

EMU2847D

Periodic maintenance

EWM01872

WARNING

These procedures require mechanical skills, tools, and supplies. If you do not have the proper skills, tools, or supplies to perform a maintenance procedure, have a Yamaha dealer or other qualified mechanic do the work.

The procedures involve disassembling the motor and exposing dangerous parts. To reduce the risk of injury from moving, hot, or electrical parts:

- Turn off the engine and keep the key(s) and engine shut-off cord (lanyard) with you when you perform maintenance unless otherwise specified.
- The power trim and tilt switches operate even when the ignition key is off. Keep people away from the switches whenever working around the motor. When the motor is tilted, keep away from the area under it or between it and the clamp bracket. Be sure no one is in this area before operating the power trim and tilt mechanism.
- Allow the engine to cool before handling hot parts or fluids.
- Always completely reassemble the motor before operation.

EMU28512

Replacement parts

If replacement parts are necessary, use only genuine Yamaha parts or parts of equivalent design and quality. Any part of inferior quality may malfunction, and the resulting loss of control could endanger the operator and passengers. Yamaha genuine parts and ac-

cessories are available from your Yamaha dealer.

EMU34152

Severe operating conditions

Severe operating conditions involve one or more of the following types of operation on a regular basis:

- Operating continuously at or near maximum engine speed (rpm) for many hours
- Operating continuously at a low engine speed (rpm) for many hours
- Operating without sufficient time for engine to warm up and cool down
- Frequent quick acceleration and deceleration
- Frequent shifting
- Frequently starting and stopping the engine(s)
- Operation that fluctuates often between light and heavy cargo loads

Outboard motors operating under any of these above conditions require more frequent maintenance. Yamaha recommends that you do this service twice as often as specified in the maintenance chart. For example, if a particular service should be done at 50 hours, do it instead at 25 hours. This will help prevent more rapid deterioration of engine components.

Maintenance

EMU34448

Maintenance chart 1

TIP:

- Refer to the sections in this chapter for explanations of each owner-specific action.
- The maintenance cycle on these charts assume usage of 100 hours per year and regular flushing of the cooling water passages. Maintenance frequency should be adjusted when operating the engine under adverse conditions such as extended trolling.
- Disassembly or repairs may be necessary depending on the outcome of maintenance checks.
- Expendable or consumable parts and lubricants will lose their effectiveness over time and through normal usage regardless of the warranty period.
- When operating in salt water, muddy, other turbid (cloudy), acidic water, the engine should be flushed with clean water after each use.

The “●” symbol indicates the check-ups which you may carry out yourself.

The “○” symbol indicates work to be carried out by your Yamaha dealer.

Item	Actions	Initial	Every		
		20 hours (3 months)	100 hours (1 year)	300 hours (3 years)	500 hours (5 years)
Anode(s) (external)	Inspection or replacement as necessary		●/○		
Anode(s) (cylinder head)	Inspection or replacement as necessary		○		
Anodes (exhaust cover, exhaust guide)	Replacement				○
Battery (electrolyte level, terminal)	Inspection	●/○	●/○		
Battery (electrolyte level, terminal)	Fill, charging or replacing as necessary		○		
Cooling water leakage	Inspection or replacement as necessary	○	○		
Cowling lock lever	Inspection		●/○		
Engine starting condition/noise	Inspection	●/○	●/○		
Engine idle speed/noise	Inspection	●/○	●/○		
Engine oil	Replacement	●/○	●/○		
Engine oil filter (cartridge)	Replacement		●/○		
Fuel filter (can be disassembled)	Inspection or replacement as necessary	●/○	●/○		
Fuel line	Inspection	●	●		

Maintenance

Item	Actions	Initial	Every			
		20 hours (3 months)	100 hours (1 year)	300 hours (3 years)	500 hours (5 years)	
Fuel line	Inspection or replacement as necessary	○	○			
Fuel pump	Inspection or replacement as necessary			○		
Fuel/engine oil leakage	Inspection	○	○			
Gear oil	Replacement	●/○	●/○			
Greasing points	Greasing	●/○	●/○			
Clamp bracket bolt (through tube)	Inspection and greasing		○			
Impeller/water pump housing	Inspection or replacement as necessary		○			
Impeller/water pump housing	Replacement			○		
Power trim and tilt unit	Inspection	●/○	●/○			
Propeller/propeller nut/cotter pin	Inspection or replacement as necessary	●/○	●/○			
Shift link/shift cable	Inspection, adjustment or replacement as necessary	○	○			
Spark plug(s)	Inspection or replacement as necessary		●/○			
Spark plug caps/spark plug wires	Inspection or replacement as necessary	○	○			
Water from the cooling water pilot hole	Inspection	●/○	●/○			
Throttle link/throttle cable/throttle pick-up timing	Inspection, adjustment or replacement as necessary	○	○			
Thermostat	Inspection or replacement as necessary		○			
Timing belt	Inspection or replacement as necessary		○			
Valve clearance	Inspection and adjustment				○	
Cooling water inlet	Inspection	●/○	●/○			
Main switch/stop switch	Inspection or replacement as necessary	○	○			
Wire harness connections/wire coupler connections	Inspection or replacement as necessary	○	○			

Maintenance

Item	Actions	Initial	Every		
		20 hours (3 months)	100 hours (1 year)	300 hours (3 years)	500 hours (5 years)
Fuel tank (Yamaha portable tank)	Inspection and cleaning as necessary		○		

EMU34452

Maintenance chart 2

Item	Actions	Every
		1000 hours
Exhaust guide/exhaust manifold	Inspection or replacement as necessary	○
Timing belt	Replacement	○

EMU28912

TIP:

When using lead or high-sulfur gasoline, inspecting valve clearance may be required more frequently than every 500 hours.

EMU28944

Greasing

Yamaha grease A (water resistant grease)

Yamaha grease D (corrosion resistant grease; for propeller shaft)

F25DMH

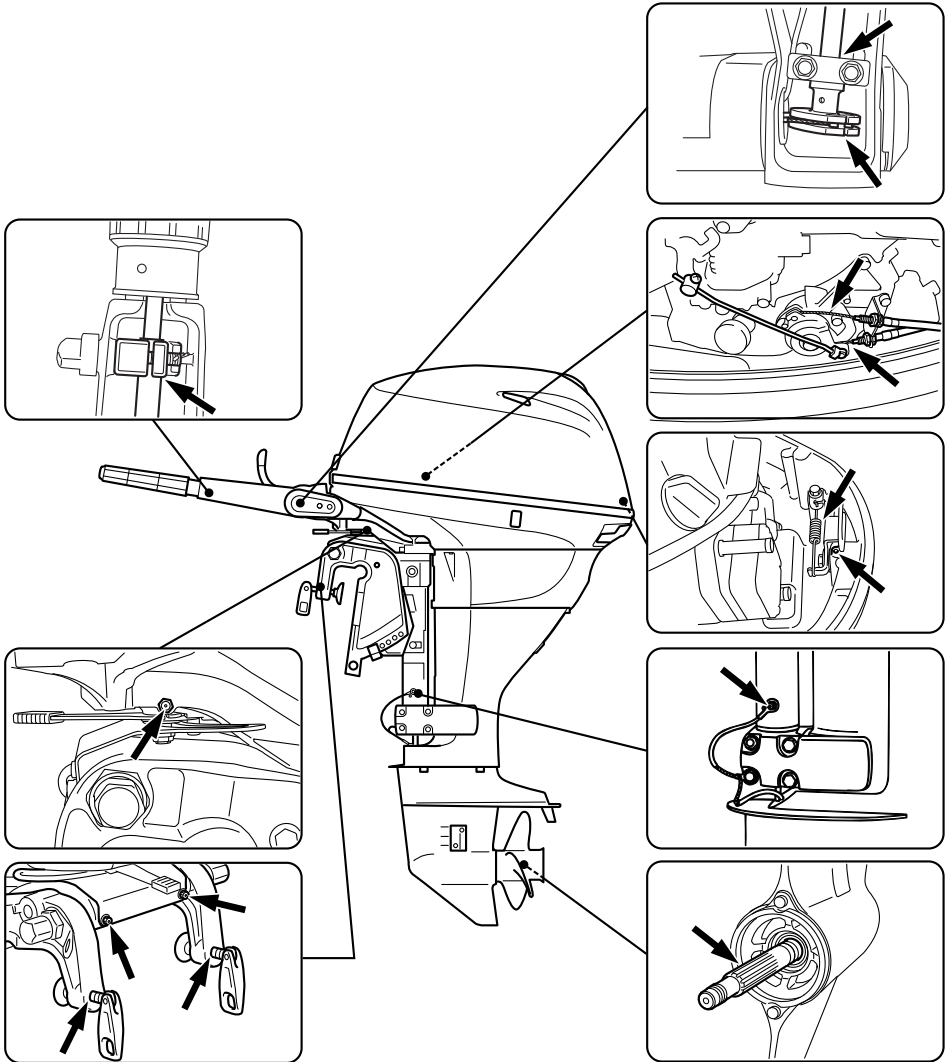

ZMU06554

Maintenance

F20DET, F25DE, F25DET, FT25FET

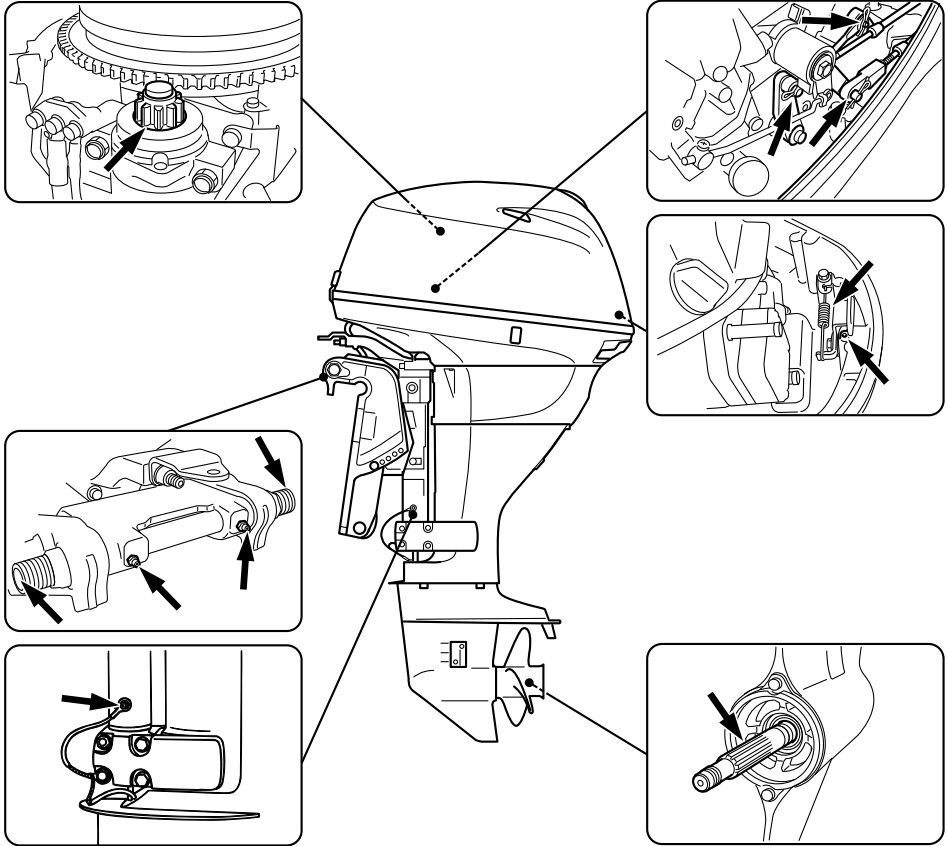

ZMU06567

EMU44850

Cleaning and adjusting spark plug

The spark plug is an important engine component and is easy to inspect. The condition of the spark plug can indicate something about the condition of the engine. For example, if the center electrode porcelain is very white, this could indicate an intake air leak or carburetion problem in that cylinder. Do not attempt to diagnose any problems yourself. Instead, take the outboard motor to a Yamaha dealer. You should periodically remove and inspect the spark plug because

heat and deposits will cause the spark plug to slowly break down and erode.

1. Remove the spark plug caps from the spark plugs.
2. Remove the spark plug. If electrode erosion becomes excessive, or if carbon and other deposits are excessive, you should replace the spark plug with another of the correct type. **WARNING!** When removing or installing a spark plug, be careful not to damage the insulator. A damaged insulator could

allow external sparks, which could lead to explosion or fire. [EWM00562]

Standard spark plug:
DPR6EB-9

3. Be sure to use the specified spark plug, otherwise the engine may not operate properly. Before fitting the spark plug, measure the electrode gap with a wire thickness gauge; replace it if out of specification.

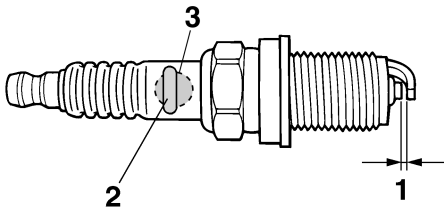

1. Spark plug gap
2. Spark plug part number
3. Spark plug I.D. mark (NGK)

Spark plug gap:
0.8–0.9 mm (0.031–0.035 in)

4. When fitting the plug, wipe off any dirt from the threads, and then screw it in to the correct torque.

Spark plug torque:
17 Nm (1.73 kgf-m, 12.5 ft-lb)

TIP:

If a torque-wrench is not available when you are reinstalling a spark plug, a good estimate of the correct torque is 1/12 turn past finger-tight. When you are installing a new spark plug, a good estimate of the correct torque is 1/2 turn past finger-tight.

EMU37451

Checking fuel filter

Check the fuel filter periodically. If any water or foreign matter is found in the filter, clean or replace it. For cleaning or replacement of the fuel filter, consult your Yamaha dealer.

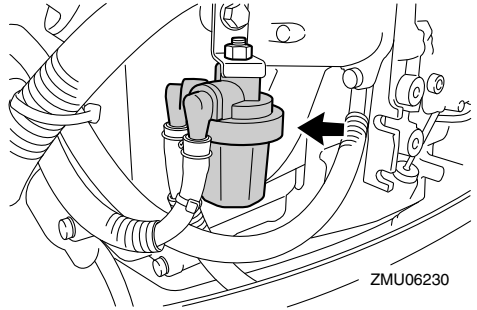

EMU29045

Inspecting idle speed

EWM00452

WARNING

- Do not touch or remove electrical parts when starting or during operation.
- Keep hands, hair, and clothes away from the flywheel and other rotating parts while the engine is running.

ECM00491

NOTICE

This procedure must be performed while the outboard motor is in the water. A flushing attachment or test tank can be used.

If the boat is not equipped with a tachometer for the outboard motor, use a diagnostic tachometer for this procedure. Results may vary depending on whether testing is conducted with the flushing attachment, in a test tank, or with the outboard motor in the water.

1. Start the engine and allow it to warm up fully in neutral until it is running smoothly.
2. Once the engine has warmed up, verify

Maintenance

whether the idle speed is set to specification. For idle speed specifications, see page 10. If you have difficulty verifying the idle speed, or the idle speed requires adjustment, consult a Yamaha dealer or other qualified mechanic.

EMU38807

Changing engine oil

EWM00761

WARNING

- **Avoid draining the engine oil immediately after stopping the engine. The oil is hot and should be handled with care to avoid burns.**
- **Be sure the outboard motor is securely fastened to the transom or a stable stand.**

ECM01711

NOTICE

Change the engine oil after the first 20 hours of operation or 3 months, and every 100 hours or at 1-year intervals thereafter. Otherwise the engine will wear quickly.

To prevent spilling oil where it could cause damage to nature, it is strongly recommended that you use an oil changer to change the engine oil. If an oil changer is not available, drain the engine oil by removing the drain screw. If you are not familiar with the procedure for changing the engine oil, consult your Yamaha dealer.

1. Put the outboard motor in an upright position (not tilted). **NOTICE: If the outboard motor is not level, the oil level indicated on the oil dipstick may not be accurate.** [ECM01862]

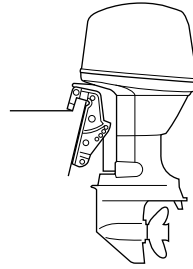

ZMU03659

2. Start the engine. Warm it up and keep the idle speed for 5-10 minutes.
3. Stop the engine and leave it for 5-10 minutes.
4. Remove the top cowling.
5. Remove the oil filler cap. Pull out the dipstick and use the oil changer to extract the oil completely.

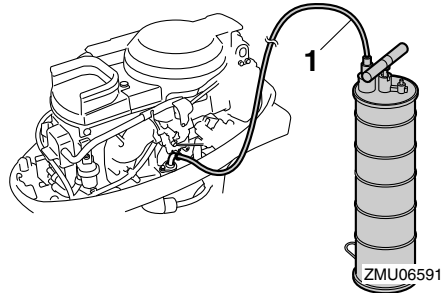

1. Oil changer

TIP:

- When using an oil changer, skip steps 6 and 7.
6. Prepare a suitable container that holds a larger amount than the engine oil capacity. Remove the drain screw and gasket while holding the container under the drain hole. Let the oil drain completely. Wipe up any spilled oil immediately.

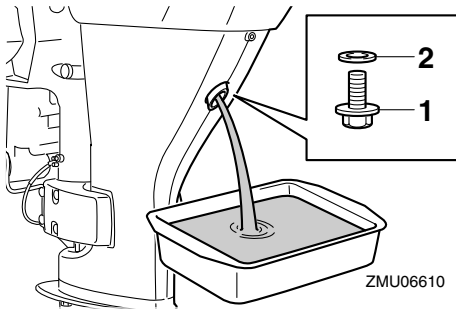

1. Drain screw
2. Gasket

TIP:

If the oil does not drain easily, change the tilt angle or turn the outboard motor to port and starboard to drain the oil.

7. Put a new gasket on the oil drain screw. Apply a light coat of oil to the gasket and install the drain screw.

Drain screw tightening torque:
27 Nm (2.75 kgf-m, 19.9 ft-lb)

TIP:

If a torque wrench is not available when you are installing the drain screw, finger tighten the screw just until the gasket comes into contact with the surface of the drain hole. Then tighten 1/4 to 1/2 turn more. Tighten the drain screw to the correct torque with a torque wrench as soon as possible.

8. Add the correct amount of oil through the filler hole. Put back the filler cap and the dipstick. **NOTICE: Overfilling the oil could cause leakage or damage. If the oil level is above the upper level mark, drain until the level meets the specified capacity.** [ECM01851]

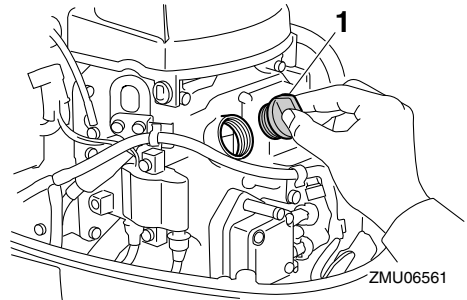

1. Oil filler cap

Recommended engine oil:

YAMALUBE 4 or 4-stroke outboard motor oil

Engine oil quantity (without oil filter replacement):

1.4 L (1.48 US qt, 1.23 Imp.qt)

Engine oil quantity (with oil filter replacement):

1.6 L (1.69 US qt, 1.41 Imp.qt)

9. Leave the outboard motor for 5-10 minutes.
10. Remove the oil dipstick and wipe it clean.
11. Insert the dipstick and remove it again. Be sure to completely insert the dipstick into the dipstick guide, otherwise the oil level measurement will be incorrect.
12. Recheck the oil level using the dipstick to be sure the level falls between the upper and lower marks. Consult your Yamaha dealer if the oil level is out of specified level.

Maintenance

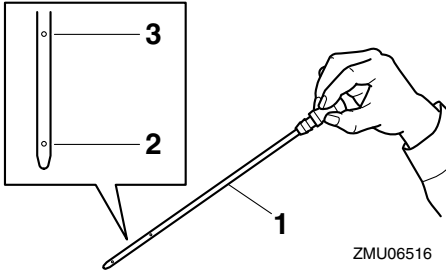

1. Oil dipstick
2. Lower mark
3. Upper mark

13. Start the engine and make sure that the low oil pressure-alert indicator remains off. Also, make sure that there are no oil leaks. **NOTICE: If the low oil pressure-alert indicator comes on or if there are oil leaks, stop the engine and find the cause. Continued operation with a problem could cause severe engine damage. Consult your Yamaha dealer if the problem cannot be located and corrected.** [ECM01623]
14. Install the top cowling.
15. Dispose of used oil according to local regulations.

TIP:

- For more information on the disposal of used oil, consult your Yamaha dealer.
- Change the oil more often when operating the engine under adverse conditions such as extended trolling.

EMU29115

Inspecting wiring and connectors

- Inspect that each connector is engaged securely.
- Inspect that each ground lead is properly secured.

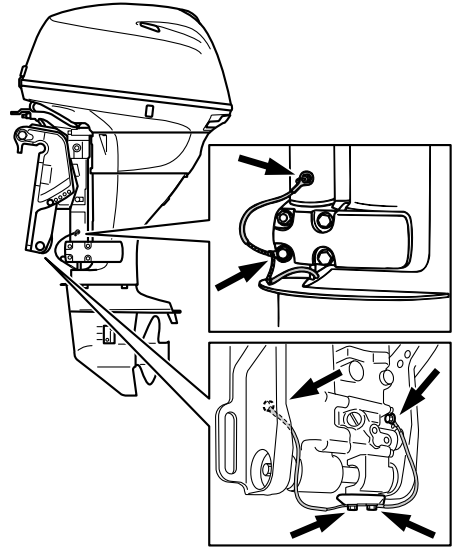

EMU32113

Checking propeller

EWMO1882



WARNING

You could be seriously injured if the engine accidentally starts when you are near the propeller. Before inspecting, removing, or installing the propeller, place the shift control in neutral, turn the main switch to "OFF" (off) and remove the key, and remove the clip from the engine shut-off switch. Turn off the battery cut-off switch if your boat has one.

Do not use your hand to hold the propeller when loosening or tightening the propeller nut. Put a wood block between the anti-cavitation plate and the propeller to prevent the propeller from turning.

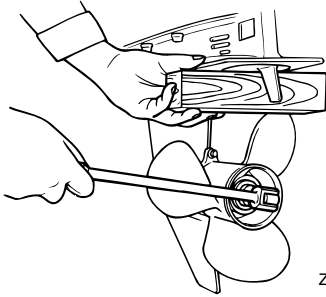

ZMU01897

Checkpoints

- Check each of the propeller blades for erosion from cavitation or ventilation, or other damage.
- Check the propeller shaft for damage.
- Check the splines for wear or damage.
- Check for fish line tangled around the propeller shaft.

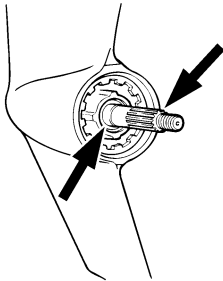

ZMU01803

- Check the propeller shaft oil seal for damage.

EMU30663

Removing propeller

EMU29198

Spline models

1. Straighten the cotter pin and pull it out using a pair of pliers.
2. Remove the propeller nut, washer, and spacer (if equipped). **WARNING! Do not use your hand to hold the propeller when loosening the propeller nut.**

[EWM01891]

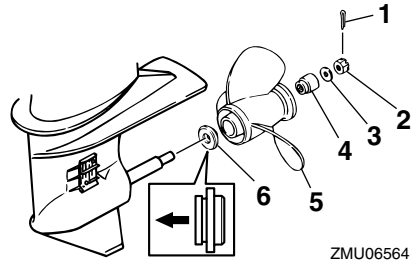

ZMU06564

1. Cotter pin
2. Propeller nut
3. Washer
4. Spacer
5. Propeller
6. Thrust washer

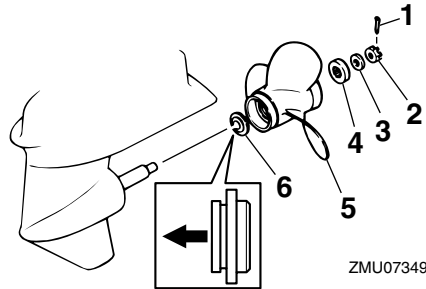

ZMU07349

1. Cotter pin
2. Propeller nut
3. Washer
4. Spacer
5. Propeller
6. Thrust washer

3. Remove the propeller, washer (if equipped), and thrust washer.

EMU30673

Installing propeller

EMU29235

Spline models

ECM00502

NOTICE

Make sure to use a new cotter pin and

Maintenance

bend the ends over securely. Otherwise, the propeller could come off during operation and be lost.

1. Apply Yamaha marine grease or a corrosion resistant grease to the propeller shaft.
2. Install the spacer (if equipped), thrust washer, washer (if equipped), and propeller on the propeller shaft. **NOTICE: Make sure to install the thrust washer before installing the propeller. Otherwise, the lower case and propeller boss could be damaged.** [ECM01882]
3. Install the spacer (if equipped) and the washer. Tighten the propeller nut to the specified torque.

Propeller nut tightening torque:
34 Nm (3.47 kgf-m, 25.1 ft-lb)

4. Align the propeller nut with the propeller shaft hole. Insert a new cotter pin in the hole and bend the cotter pin ends. **NOTICE: Do not reuse the cotter pin. Otherwise, the propeller can come off during operation.** [ECM01892]

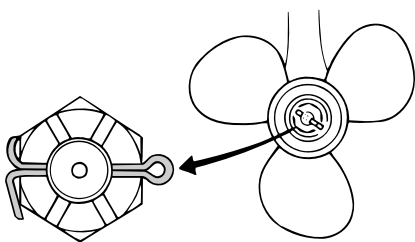

ZMU02063

TIP:

If the propeller nut does not align with the propeller shaft hole after tightening to the specified torque, tighten the nut further to align it with the hole.

EMU2928C

Changing gear oil

EWMM00801



- Be sure the outboard motor is securely fastened to the transom or a stable stand. You could be severely injured if the outboard motor falls on you.
- Never get under the lower unit while it is tilted, even when the tilt support lever or knob is locked. Severe injury could occur if the outboard motor accidentally falls.

1. Tilt the outboard motor so that the gear oil drain screw is at the lowest point possible.
2. Place a suitable container under the gear case.
3. Remove the gear oil drain screw and gasket. **NOTICE: If there is an excessive quantity of metal particles on the magnetic gear oil drain screw, this can indicate lower unit problem. Consult your Yamaha dealer.** [ECM01901]

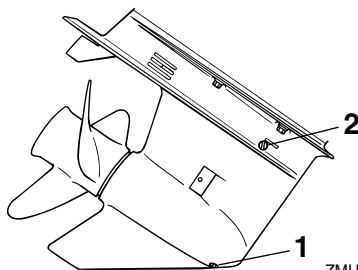

ZMU03273

1. Gear oil drain screw
2. Oil level plug

TIP:

- If a magnetic gear oil drain screw is equipped, remove all metal particles from the screw before installing it.

- Always use new gaskets. Do not reuse the removed gaskets.
4. Remove the oil level plug and gasket to allow the oil to drain completely.
NOTICE: Check the used gear oil after it has been drained. If the gear oil is milky or contains water or a large amount of metal particles, the gear case may be damaged. Have a Yamaha dealer check and repair the outboard motor. [ECM00714]

TIP:

For disposal of used oil, consult your Yamaha dealer.

5. Put the outboard motor in a vertical position. Using a flexible or pressurized filling device, inject the gear oil into the gear oil drain screw hole.

Recommended gear oil:

YAMALUBE outboard gear oil or Hypoid gear oil

Recommended gear oil grade:

SAE 90 API GL-4

Gear oil quantity:

F20DET 0.320 L (0.338 US qt, 0.282 Imp.qt)

F25DE 0.320 L (0.338 US qt, 0.282 Imp.qt)

F25DET 0.320 L (0.338 US qt, 0.282 Imp.qt)

F25DMH 0.320 L (0.338 US qt, 0.282 Imp.qt)

FT25FET 0.430 L (0.455 US qt, 0.378 Imp.qt)

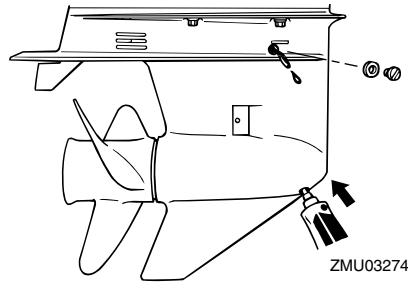

6. Put a new gasket on the oil level plug. When the oil begins to flow out of the oil level plug hole, insert and tighten the oil level plug.

Tightening torque:

9 Nm (0.92 kgf-m, 6.6 ft-lb)

7. Put a new gasket on the gear oil drain screw. Insert and tighten the gear oil drain screw.

Tightening torque:

9 Nm (0.92 kgf-m, 6.6 ft-lb)

EMU29304

Cleaning fuel tank

EWM00921

WARNING

Gasoline is highly flammable, and its vapors are flammable and explosive.

- If you have any question about properly doing this procedure, consult your Yamaha dealer.
- Keep away from sparks, cigarettes, flames, or other sources of ignition when cleaning the fuel tank.
- Remove the fuel tank from the boat before cleaning it. Work only outdoors in an area with good ventilation.
- Wipe up any spilled fuel immediately.
- Reassemble the fuel tank carefully. Improper assembly can result in a fuel

Maintenance

leak, which could result in a fire or explosion hazard.

- **Dispose of old gasoline according to local regulations.**

1. Empty the fuel tank into an approved container.
2. Pour a small amount of suitable solvent into the tank. Install the cap and shake the tank. Drain the solvent completely.
3. Remove the screws holding the fuel joint assembly. Pull the assembly out of the tank.

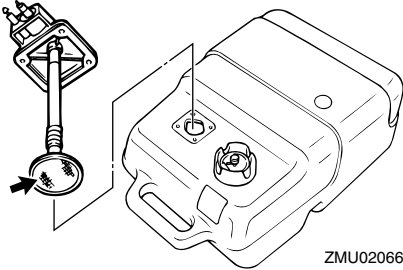

4. Clean the filter (located on the end of the suction pipe) in a suitable cleaning solvent. Allow the filter to dry.
5. Replace the gasket with a new one. Reinstall the fuel joint assembly and tighten the screws firmly.

EMU29317

Inspecting and replacing anode(s)

Yamaha outboard motors are protected from corrosion by sacrificial anodes. Inspect the external anodes periodically. Remove scales from the surfaces of the anodes. Consult a Yamaha dealer for replacement of external anodes.

ECM00721

NOTICE

Do not paint anodes, as this would render them ineffective.

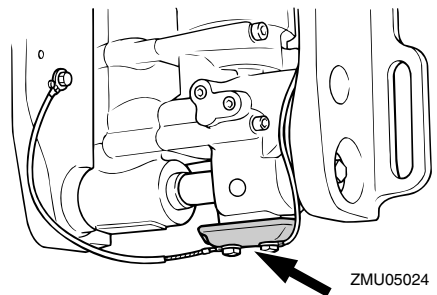
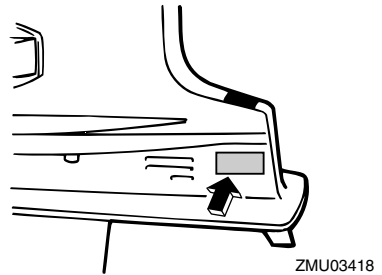
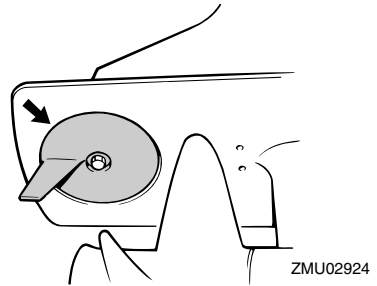
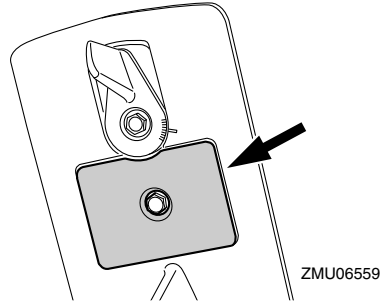

TIP:

Inspect ground leads attached to external anodes on equipped models. Consult a Yamaha dealer for inspection and replacement of internal anodes attached to the power unit.

EMU29324

Checking battery (for electric start models)

EWM01903

WARNING

Battery electrolyte is poisonous and caustic, and batteries generate explosive hydrogen gas. When working near the battery:

- Wear protective eye gear and rubber gloves.
- Do not smoke or bring any other source of ignition near the battery.

The procedure for checking the battery varies for different batteries. This procedure contains typical checks that apply to many batteries, but you should always refer to the battery manufacturer's instructions.

ECM01921

NOTICE

A poorly maintained battery will quickly deteriorate.

1. Check the electrolyte level.

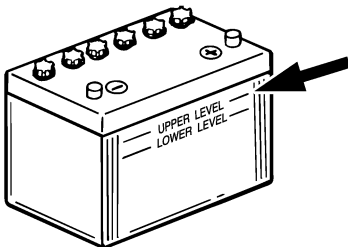

ZMU01810

2. Check the battery's charge. If your boat

is equipped with the digital speedometer, the voltmeter and low battery alert functions will help you monitor the battery's charge. If the battery needs charging, consult your Yamaha dealer.

3. Check the battery connections. They should be clean, secure, and covered by an insulating cover. **WARNING! Bad connections can produce shorting or arcing and cause an explosion.**

[EWM01913]

EMU29335

Connecting the battery

EWM00573

WARNING

Mount the battery holder securely in a dry, well-ventilated, vibration-free location in the boat. Install a fully charged battery in the holder.

ECM01125

NOTICE

Do not reverse the battery cables. Otherwise, the electrical parts could be damaged.

1. Make sure the main switch (on applicable models) is "OFF" (off) before working on the battery.
2. Connect the red battery cable to the POSITIVE (+) terminal first. Then connect the black battery cable to the NEGATIVE (-) terminal.

Maintenance

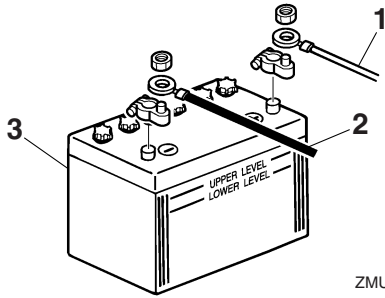

ZMU01811

1. Red cable
2. Black cable
3. Battery

3. The electrical contacts of the battery and cables must be clean and properly connected, or the battery will not start the engine.

EMU29372

Disconnecting the battery

1. Turn off the battery cut-off switch (if equipped) and main switch. **NOTICE: If they are left on, the electrical system can be damaged.** [ECM01931]
2. Disconnect the negative cable(s) from the negative (-) terminal. **NOTICE: Always disconnect all negative (-) cables first to avoid a short circuit and damage to the electrical system.** [ECM01941]
3. Disconnect the positive cable(s) and remove the battery from the boat.
4. Clean, maintain, and store the battery according to the manufacturer's instructions.

EMU29428

Troubleshooting

A problem in the fuel, compression, or ignition systems can cause poor starting, loss of power, or other problems. This section describes basic checks and possible remedies, and covers all Yamaha outboard motors. Therefore some items may not apply to your model.

If your outboard motor requires repair, bring it to your Yamaha dealer.

If the engine trouble-alert indicator is flashing, consult your Yamaha dealer.

Starter will not operate.

Q. Is battery capacity weak or low?

A. Check battery condition. Use battery of recommended capacity.

Q. Are battery connections loose or corroded?

A. Tighten battery cables and clean battery terminals.

Q. Is fuse for electric start relay or electric circuit blown?

A. Check for cause of electric overload and repair. Replace fuse with one of correct amperage.

Q. Are starter components faulty?

A. Have serviced by a Yamaha dealer.

Q. Is shift lever in gear?

A. Shift to neutral.

Engine will not start (starter operates).

Q. Is fuel tank empty?

A. Fill tank with clean, fresh fuel.

Q. Is fuel contaminated or stale?

A. Fill tank with clean, fresh fuel.

Q. Is fuel filter clogged?

A. Clean or replace filter.

Q. Is starting procedure incorrect?

A. See page 40.

Q. Has fuel pump malfunctioned?

A. Have serviced by a Yamaha dealer.

Q. Are spark plug(s) fouled or of incorrect type?

A. Inspect spark plug(s). Clean or replace with recommended type.

Q. Are spark plug cap(s) fitted incorrectly?

A. Check and re-fit cap(s).

Q. Is ignition wiring damaged or poorly connected?

A. Check wires for wear or breaks. Tighten all loose connections. Replace worn or broken wires.

Q. Are ignition parts faulty?

A. Have serviced by a Yamaha dealer.

Q. Is engine shut-off cord (lanyard) not attached?

A. Attach cord.

Q. Are engine inner parts damaged?

A. Have serviced by a Yamaha dealer.

Engine idles irregularly or stalls.

Q. Are spark plug(s) fouled or of incorrect type?

A. Inspect spark plug(s). Clean or replace with recommended type.

Trouble Recovery

Q. Is fuel system obstructed?

A. Check for pinched or kinked fuel line or other obstructions in fuel system.

Q. Is fuel contaminated or stale?

A. Fill tank with clean, fresh fuel.

Q. Is fuel filter clogged?

A. Clean or replace filter.

Q. Have ignition parts failed?

A. Have serviced by a Yamaha dealer.

Q. Has alert system activated?

A. Find and correct cause of alert.

Q. Is spark plug gap incorrect?

A. Inspect and adjust as specified.

Q. Is ignition wiring damaged or poorly connected?

A. Check wires for wear or breaks. Tighten all loose connections. Replace worn or broken wires.

Q. Is specified engine oil not being used?

A. Check and replace oil as specified.

Q. Is thermostat faulty or clogged?

A. Have serviced by a Yamaha dealer.

Q. Are carburetor adjustments incorrect?

A. Have serviced by a Yamaha dealer.

Q. Is fuel pump damaged?

A. Have serviced by a Yamaha dealer.

Q. Is air vent screw on fuel tank closed?

A. Open air vent screw.

Q. Is choke knob pulled out?

A. Return to home position.

Q. Is motor angle too high?

A. Return to normal operating position.

Q. Is carburetor clogged?

A. Have serviced by a Yamaha dealer.

Q. Is fuel joint connection incorrect?

A. Connect correctly.

Q. Is throttle valve adjustment incorrect?

A. Have serviced by a Yamaha dealer.

Q. Is battery cable disconnected?

A. Connect securely.

Alert buzzer sounds or indicator lights.

Q. Is cooling system clogged?

A. Check water intake for restriction.

Q. Is engine oil level low?

A. Fill oil tank with specified engine oil.

Q. Is heat range of spark plug incorrect?

A. Inspect spark plug and replace it with recommended type.

Q. Is specified engine oil not being used?

A. Check and replace oil with specified type.

Q. Is engine oil contaminated or deteriorated?

A. Replace oil with fresh, specified type.

Q. Is oil filter clogged?

A. Have serviced by a Yamaha dealer.

Q. Has oil feed/injection pump malfunctioned?

A. Have serviced by a Yamaha dealer.

Q. Is load on boat improperly distributed?

A. Distribute load to place boat on an even plane.

Q. Is water pump or thermostat faulty?

A. Have serviced by a Yamaha dealer.

Q. Is there excess water in fuel filter cup?

A. Drain filter cup.

Engine power loss.

Q. Is propeller damaged?

A. Have propeller repaired or replaced.

Q. Is propeller pitch or diameter incorrect?

A. Install correct propeller to operate outboard at its recommended speed (r/min) range.

Q. Is trim angle incorrect?

A. Adjust trim angle to achieve most efficient operation.

Q. Is motor mounted at incorrect height on transom?

A. Have motor adjusted to proper transom height.

Q. Has alert system activated?

A. Find and correct cause of alert.

Q. Is boat bottom fouled with marine growth?

A. Clean boat bottom.

Q. Are spark plug(s) fouled or of incorrect type?

A. Inspect spark plug(s). Clean or replace with recommended type.

Q. Are weeds or other foreign matter tangled

on gear housing?

A. Remove foreign matter and clean lower unit.

Q. Is fuel system obstructed?

A. Check for pinched or kinked fuel line or other obstructions in fuel system.

Q. Is fuel filter clogged?

A. Clean or replace filter.

Q. Is fuel contaminated or stale?

A. Fill tank with clean, fresh fuel.

Q. Is spark plug gap incorrect?

A. Inspect and adjust as specified.

Q. Is ignition wiring damaged or poorly connected?

A. Check wires for wear or breaks. Tighten all loose connections. Replace worn or broken wires.

Q. Have electrical parts failed?

A. Have serviced by a Yamaha dealer.

Q. Is specified fuel not being used?

A. Replace fuel with specified type.

Q. Is specified engine oil not being used?

A. Check and replace oil with specified type.

Q. Is thermostat faulty or clogged?

A. Have serviced by a Yamaha dealer.

Q. Is air vent screw closed?

A. Open the air vent screw.

Q. Is fuel pump damaged?

A. Have serviced by a Yamaha dealer.

Trouble Recovery

Q. Is fuel joint connection incorrect?

A. Connect correctly.

Q. Is heat range of spark plug incorrect?

A. Inspect spark plug and replace it with recommended type.

Q. Is high pressure fuel pump drive belt broken?

A. Have serviced by a Yamaha dealer.

Q. Is engine not responding properly to shift lever position?

A. Have serviced by a Yamaha dealer.

Engine vibrates excessively.

Q. Is propeller damaged?

A. Have propeller repaired or replaced.

Q. Is propeller shaft damaged?

A. Have serviced by a Yamaha dealer.

Q. Are weeds or other foreign matter tangled on propeller?

A. Remove and clean propeller.

Q. Is motor mounting bolt loose?

A. Tighten bolt.

Q. Is steering pivot loose or damaged?

A. Tighten or have serviced by a Yamaha dealer.

EMU29434

Temporary action in emergency

EMU29442

Impact damage

EWM00871



The outboard motor can be seriously damaged by a collision while operating or

trailing. Damage could make the outboard motor unsafe to operate.

If the outboard motor hits an object in the water, follow the procedure below.



1. Stop the engine immediately.
2. Check the control system and all components for damage. Also, check the boat for damage.
3. Whether damage is found or not, return to the nearest harbor slowly and carefully.
4. Have a Yamaha dealer check the outboard motor before operating it again.

EMU30684

Replacing fuse

If a fuse has blown, open the fuse holder and remove the fuse with a fuse puller. Replace it with a spare one of the proper amperage.

EWM00632



Substituting an incorrect fuse or a piece of wire could allow excessive current flow. This could cause electric system damage and a fire hazard.

Consult your Yamaha dealer if the new fuse immediately blows again.

Trouble Recovery

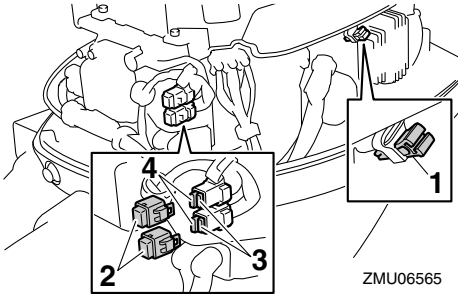

ZMU06565

1. Fuse puller
2. Cap
3. Fuse (20 A, 30 A)
4. Spare fuse (20 A, 30 A)

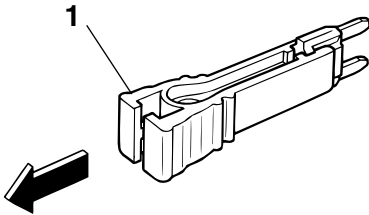

ZMU04337

1. Fuse puller

EMU29513

Power trim and tilt will not operate

If the engine cannot be tilted up or down with the power trim and tilt because of a discharged battery or a failure with the power trim and tilt unit, the engine can be tilted manually.

1. Loosen the manual valve screw by turning it clockwise until it stops.

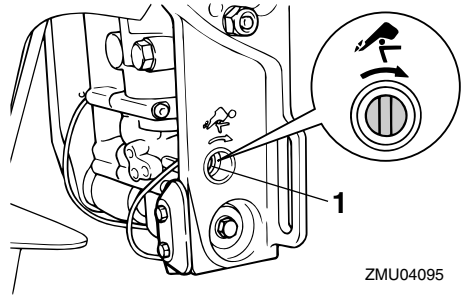

ZMU04095

1. Manual valve screw
2. Put the engine in the desired position, then tighten the manual valve screw by turning it counterclockwise.

EMU29534

Starter will not operate

If the starter mechanism does not operate (the engine cannot be cranked with the starter), the engine can be started with an emergency starter rope.

EWMO1023

WARNING

- Use this procedure only in an emergency to return to the nearest port for repairs.
- When the emergency starter rope is used to start the engine, the start-in-gear protection device does not operate. Make sure the remote control lever is in neutral. Otherwise the boat could unexpectedly start to move, which could result in an accident.
- Attach the engine shut-off cord to a secure place on your clothing, or your arm or leg while operating the boat.
- Do not attach the cord to clothing that could tear loose. Do not route the cord where it could become entangled, preventing it from functioning.
- Avoid accidentally pulling the cord dur-

Trouble Recovery

ing normal operation. Loss of engine power means the loss of most steering control. Also, without engine power, the boat could slow rapidly. This could cause people and objects in the boat to be thrown forward.

- Make sure no one is standing behind you when pulling the starter rope. It could whip behind you and injure someone.
- An unguarded, rotating flywheel is very dangerous. Keep loose clothing and other objects away when starting the engine. Use the emergency starter rope only as instructed. Do not touch the flywheel or other moving parts when the engine is running. Do not install the starter mechanism or top cowling after the engine is running.
- Do not touch the ignition coil, spark plug wire, spark plug cap, or other electrical components when starting or operating the motor. You could get an electrical shock.

EMU38841

Emergency starting engine (manual start model)

1. Remove the top cowling and protective cover.

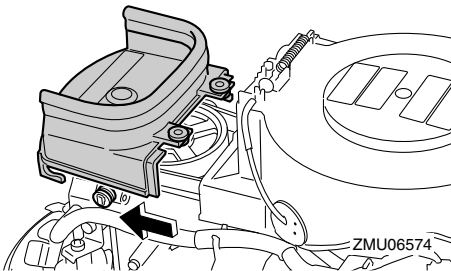

2. Remove the grommet and disconnect the start-in-gear protection cable from

the manual starter.

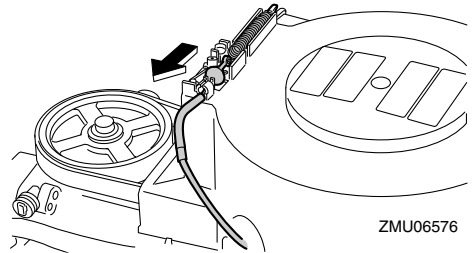
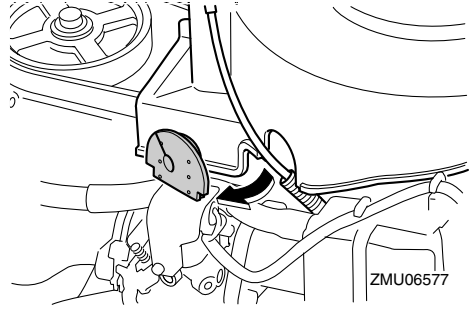

3. Remove the manual starter after removing the bolt(s).

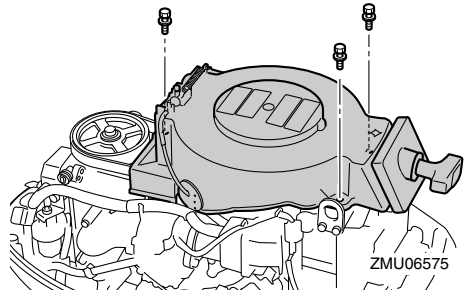

Trouble Recovery

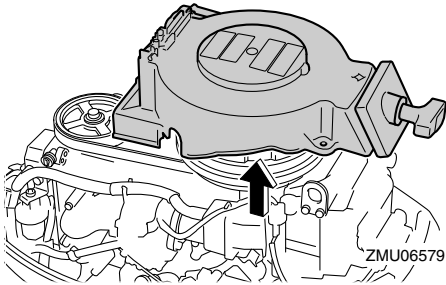

4. Pass the start-in-gear protection cable under the fuel line and remove the spring from it.

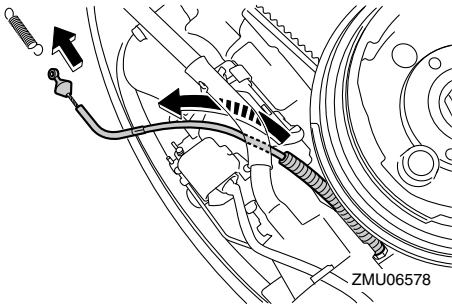

5. Be sure that the gear shift is in neutral and that the clip is attached to the engine shut-off switch.

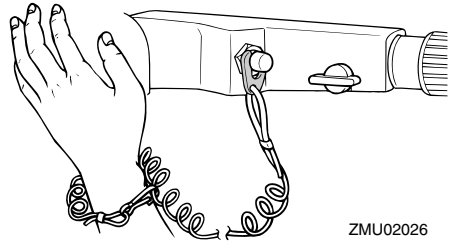
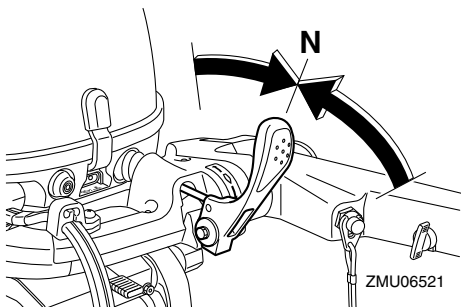

6. Insert the knotted end of the emergency starter rope into the notch in the flywheel magnet and wind the rope 1 or 2 turn(s) around the flywheel magnet clockwise.
7. Pull the rope slowly until resistance is felt. Give a strong pull straight out to crank and start the engine. If the engine does not start on the first try, repeat the procedure.

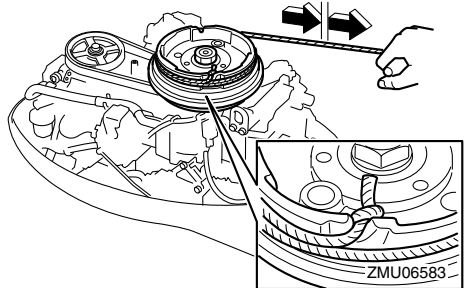

TIP:

- If the engine does not start on the first try, repeat the procedure. If the engine fails to start after 4 or 5 tries, open the throttle a small amount (between 1/8 and 1/4) and try again. Also if the engine is warm and fails to start, open the throttle a same amount and try to start the engine again. If the engine still fails to start, see page 40.
- Slowly return the throttle grip to the fully closed position so that the engine does not stall.

Trouble Recovery

EMU38852

Emergency starting engine (electric start model)

1. Remove the top cowling and protective cover.

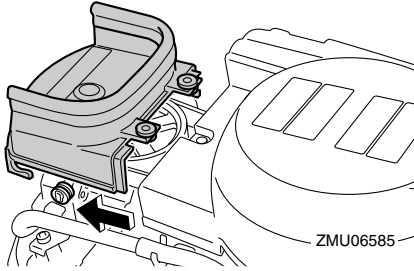

2. Pull off the 10-pin connector from the clamp and remove the flywheel magnet cover (if equipped).

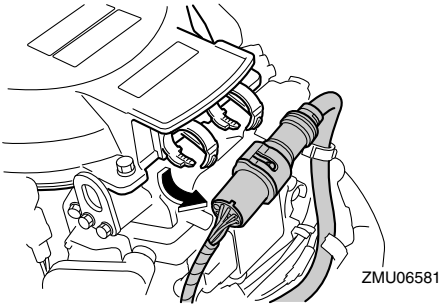

3. Remove the flywheel magnet cover after removing the bolt(s).

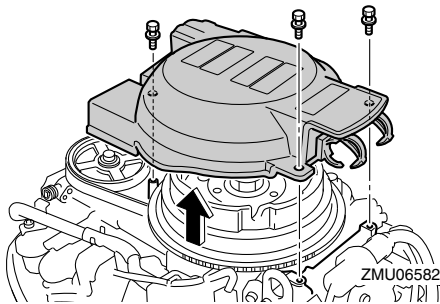

4. Be sure that the gear shift is in neutral

and that the clip is attached to the engine shut-off switch. The main switch must be "ON" (on), if equipped.

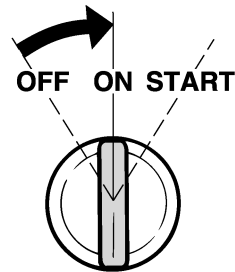
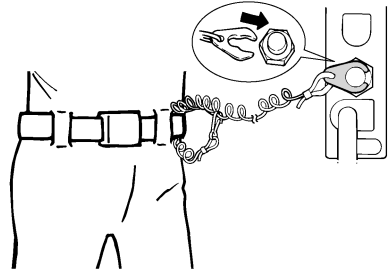
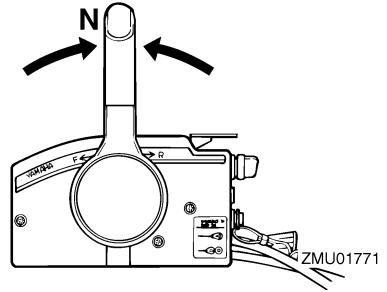

5. Insert the knotted end of the emergency starter rope into the notch in the flywheel magnet and wind the rope 1 or 2 turn(s) around the flywheel magnet clockwise.
6. Pull the rope slowly until resistance is felt. Give a strong pull straight out to crank and start the engine. If the engine does not start on the first try, repeat the

procedure.

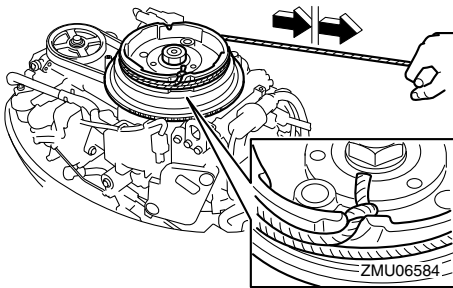

TIP:

- If the engine does not start on the first try, repeat the procedure. If the engine fails to start after 4 or 5 tries, open the throttle a small amount (between 1/8 and 1/4) and try again. Also if the engine is warm and fails to start, open the throttle a same amount and try to start the engine again. If the engine still fails to start, see page 40.
- Slowly return the throttle grip to the fully closed position so that the engine does not stall.

EMU33502

Treatment of submerged motor

If the outboard motor is submerged, immediately take it to a Yamaha dealer. Otherwise some corrosion may begin almost immediately. **NOTICE: Do not attempt to run the outboard motor until it has been completely inspected.** [ECM00402]

INDEX

- A**
- Alcohol and drugs 2
 - Alert indicator 27
 - Alert system 29
 - Anode(s), inspecting and replacing 74
 - Anti-fouling paint 15
 - Avoid collisions 3
- B**
- Battery 38
 - Battery, checking (electric start models) 75
 - Battery, connecting 75
 - Battery, disconnecting 76
 - Battery requirements 12
 - Boat horsepower rating 12
 - Boating safety 2
 - Boating safety publications 3
 - Breaking in engine 34
- C**
- Carbon monoxide 2
 - CE Marking 4
 - Checks after engine warm up 45
 - Checks after starting engine 44
 - Checks before starting engine 34
 - Clamping the outboard motor 32
 - Cleaning the outboard motor 60
 - Components diagram 17
 - Control functions, checking 35
 - Cooling water 44
 - Cowling lock lever 26
 - Cruising in salt water or other conditions 55
- E**
- EC Declaration of Conformity (DoC) 4
 - Electric shock 1
 - Emergency equipment 16
 - Emergency starting engine (electric start model) 84
 - Emergency starting engine (manual start model) 82
 - Emergency, temporary action in 80
- Engine, checking** 37
- Engine oil** 36
- Engine oil, changing 68
 - Engine oil, filling 34
 - Engine oil requirements 14
 - Engine shut-off cord (lanyard) 1, 36
 - Engine shut-off cord (lanyard) and clip 21
 - Engine stop button 22
- F**
- Filling fuel 38
 - First-time operation 34
 - Flushing device 27, 37
 - Flushing in a test tank 57
 - Flushing power unit 59
 - Fuel filter, checking 35, 67
 - Fuel leaks, checking for 35
 - Fuel level 35
 - Fuel requirements 15
 - Fuel system 35
 - Fuel tank 18
 - Fuel tank, cleaning 73
 - Fuse, replacing 80
- G**
- Gasoline 1, 15
 - Gasoline exposure and spills 2
 - Gear oil, changing 72
 - Gear shift lever 20
 - Greasing 65
- H**
- Hot parts 1
- I**
- Identification numbers record 4
 - Idle speed, inspecting 67
 - Impact damage 80
 - Installation requirements 12
 - Instruments and indicators 28
- K**
- Key number 4

L			
Laws and regulations.....	3	Power trim and tilt will not operate	81
Low oil pressure alert.....	29	Propeller	1
Low oil pressure-alert indicator.....	28	Propeller, checking	70
Lubrication	58	Propeller, installing	71
		Propeller, removing.....	71
		Propeller selection	13
M		R	
Main switch.....	22	Read manuals and labels	6
Maintenance chart 1	62	Rectifier Regulator (optional)	13
Maintenance chart 2	64	Remote control box.....	19
Manual starter handle	22	Remote control lever.....	19
Modifications.....	2	Remote control requirements	12
Motor disposal requirements	15	Replacement parts.....	60
Mounting height.....	31	Rotating parts	1
Mounting motor.....	12		
Mounting the outboard motor.....	31	S	
Muddy or acidic water.....	15	Sending fuel (portable tank).....	40
		Severe operating conditions	61
N		Shallow water	53
Neutral interlock trigger.....	20	Shifting.....	45
Neutral throttle lever	20	Shifting (checks after engine warm up)	45
		Spark plug, cleaning and adjusting.....	66
O		Specifications.....	10
Operating engine	39	Starter will not operate	81
Outboard motor (painted surface), checking	60	Start-in-gear protection	14
Outboard motor safety	1	Starting engine.....	40
Outboard motor serial number.....	4	Steering friction adjuster	23
Overheat alert.....	29	Stopping boat.....	46
Overheat-alert indicator	28	Stopping engine	47
Overloading	2	Stop switches.....	45
		Storing outboard motor	57
P		Submerged outboard motor	85
Passengers.....	2		
Passenger training.....	3	T	
People in the water.....	2	Throttle friction adjuster	21
Periodic maintenance	60	Throttle grip.....	20
Personal flotation devices (PFDs)	2	Throttle indicator.....	21
Power trim and tilt.....	1	Tiller handle	20
Power trim and tilt switch (bottom cowling)	24	Tilting up and down.....	50
Power trim and tilt switch (remote control)	23	Tilt lock mechanism	25
Power trim and tilt system, checking	38	Tilt support bar	26
		Tilt support knob	26

INDEX

Top cowling, installing.....	37
Top cowling, removing.....	35
Transporting and storing outboard motor	56
Trimming outboard motor	47
Trim rod (tilt pin).....	25
Trim tab.....	25
Trim tab with anode	24
Troubleshooting	77

W

Warming up engine.....	44
Warning labels	6
Weather	3
Wiring and connectors, inspecting.....	70

