



**OWNER'S MANUAL**  
**MANUEL DU PROPRIÉTAIRE**  
**USO E MANUTENZIONE**  
**INSTRUKTIONSBOK**  
**OMISTAJAN KÄSIKIRJA**  
**EIERHÅNDBOK**

(E)  
(F)  
(I)  
(S)  
(SF)  
(N)

- (E) ⚠ Read this manual carefully before operating this vehicle.
- (F) ⚠ Il convient de lire attentivement ce manuel avant la première utilisation du véhicule.
- (I) ⚠ Leggere attentamente questo manuale prima di utilizzare questo veicolo.
- (S) ⚠ Läs den här instruktionsboken noga innan snöskotern används.
- (SF) ⚠ Lue tämä käsikirja huolellisesti ennen moottorikelkan käyttöä.
- (N) ⚠ Les denne håndboken nøye før du tar kjøretøyet i bruk.

**SR10ARLG**      **SR10AM53G**  
**SR10ALLG**      **SR1AMS53G**  
**SR1ASD37G**      **SR1AML53G**  
**SR1ASD46G**      **SR10AM62G**  
**SR10AXLG**      **SR1AML62G**  
**SR1AMS41G**

Original instructions  
Notice originale  
Istruzioni originali  
Bruksanvisning i original  
Alkuperäiset ohjeet  
Opprinnelige instruksjoner



PRINTED IN U.S.A.



**OWNER'S MANUAL**



**⚠ Read this manual carefully  
before operating this vehicle.**

**SR10ARLG  
SR10ALLG  
SR1ASD37G  
SR1ASD46G  
SR10AXLG  
SR1AMS41G**

**SR10AM53G  
SR1AMS53G  
SR1AML53G  
SR10AM62G  
SR1AML62G**

 **Read this manual carefully before operating this vehicle. This manual should stay with this vehicle if it is sold.**

## **EC Declaration of Conformity**

conforming to Directive 2006/42/EC

**We, YAMAHA MOTOR CO., LTD. 2500 Shingai, Iwata, Japan,  
declare in sole responsibility, that the product**

SRV10RL(SR10ARL) (4UF8KN50*GT000001-)	SRV10SD37(SR1ASD37) (4UF8LJ20*GT000001-)
SRV10LL(SR10ALL) (4UF8KP40*GT000001-)	SRV10XL(SR10AXL) (4UF8LH20*GT000001-)
SRV10MS53(SR1AMS53) (4UF8KS40*GT000001-)	SRV10ML53(SR1AML53) (4UF8LL20*GT000001-)
SRV10ML62(SR1AML62) (4UF8KU40*GT000001-)	SRV10M62(SR10AM62) (4UF8LM20*GT000001-)
SRV10MS53(SR10AM53) (4UF8KG40*GT000001-)	SRV10SD46(SR1ASD46) (4UF8LN20*GT000001-)
SRV10MS41(SR1AMS41) (4UF8LK20*GT000001-)	

---

(Make, model)

**to which this declaration applies, conforms to the essential health and safety requirements of Directive 2006/42/EC**

(If applicable)

**and to the other relevant Directive of EEC**

**2004/108/EC**

---

(Title and/or number and date of issue of the other Directives of EEC)

(If applicable)

**To effect correct application of the essential health and safety requirements stated in the Directives of EEC, the following-standards and/or technical specifications were consulted:**

---

(Title and/or number and date of issue of standards and/or specifications)

### **Authorized Representative**

YAMAHA MOTOR EUROPE N.V.

Koolhovenlaan 101, 1119 NC Schiphol-Rijk, The Netherlands

Signature

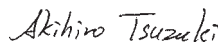

Akihiro Tsuzuki

General Manager

Engineering Div., RV Business Unit

Business Development Operations

Date of Issue

13 January, 2015

# Table of Contents

Foreword .....	2	Lubrication .....	19-20
General Information .....	3-14	Chain Case .....	19
Snowmobile Identification .....	3	Rear Suspension .....	20
Control Locations .....	3	Maintenance .....	21-42
Gasoline-Oil .....	4	Periodic Maintenance Checklist .....	21
Engine Break-In .....	4	Fuel System .....	22
Drive Belt Break-In .....	5	Checking Engine Oil Level .....	22
Cold Drive-Away Function .....	5	Changing Engine Oil/Filter .....	22
Speedometer/Tachometer/Digital Gauge .....	5	Coolant Level .....	24
Diagnostic Codes .....	7	Spark Plugs .....	24
Handlebar Tilt (Mountain Models) .....	8	Checking/Adjusting Valve Clearance .....	25
Handlebar Tilt (SR10 Models) .....	8	Battery .....	25
Exhaust System .....	8	Fuses .....	27
Air-Intake Silencer .....	8	Brake System .....	28
Cooling System .....	9	Burnishing Brake Pads .....	30
Battery .....	9	Chain Tension .....	31
Jump-Starting .....	9	Drive Belt .....	31
Drive Clutch and Driven Clutch .....	10	Track Tension .....	33
Drive Clutch/Driven Clutch Alignment .....	11	Track Alignment .....	34
Fuel Pump .....	11	Suspension .....	35
Shock Absorbers (Rebuildable Gas) .....	11	Adjusting Skid Frame Rear Shock (Limited Models) .....	37
Track/Track Studs .....	11	Adjusting Rear Spring Pre-Load .....	37
Paddle Track (On Equipped Models) .....	12	Lights .....	38
Reverse Operation .....	12	Ski Wear Bars .....	39
Access Panel/Hood .....	13	Adjusting Ski Stance .....	40
Removable Seat .....	13	Single Wear Bar .....	40
Towing .....	14	Dual Wear Bar .....	41
Operating Instructions .....	15-18	Rail Wear Strips .....	41
Starting and Stopping Engine .....	15	Performance Tips .....	43-44
Braking .....	16	Preparation for Storage .....	45
Emergency Stopping .....	17	Preparation after Storage .....	46
Throttle/Ignition Monitor Switch .....	17	Snowmobile Safety Rules .....	47
Varying Altitude Operation .....	18		

# Reference Information

Write the appropriate information for your Yamaha Snowmobile in the spaces below.

Always use these numbers when referring to your snowmobile.

Model: \_\_\_\_\_

Date of Purchase: \_\_\_\_\_

Vehicle Identification Number: \_\_\_\_\_

Engine Serial Number: \_\_\_\_\_

**Your Yamaha Dealer:** \_\_\_\_\_

**Address:** \_\_\_\_\_

**Phone:** \_\_\_\_\_

## WARNING

**A snowmobile is a very high performance vehicle. Because it does accelerate rapidly and is capable of very high speeds, it should not be operated by a novice or an inexperienced operator. Never accelerate rapidly or drive at high speed beyond the limits of visibility or without being totally familiar with the terrain and what lies in front of you. Obey speed limits and never operate at speeds that do not allow adequate maneuvering and stopping distances. Read and study the entire Operator's Manual and Safety Handbook. Failure to follow this warning could result in personal injury to yourself or others.**

### Personal Injury



- To avoid injury to yourself and others, NEVER operate the snowmobile without first reading and understanding this manual and the Snowmobile Safety Handbook; then follow the instructions and heed the warnings given.
- USE COMMON SENSE.
- DON'T DRINK and DRIVE.
- STAY IN CONTROL at ALL TIMES.
- TELL YOUR FRIENDS. If you see a friend operating a snowmobile recklessly, at excessive speeds, while intoxicated, or in other unsafe ways, don't wait until it is too late to warn of the consequences of snowmobile misuse. Such conduct endangers everyone. TAKE AN ACTIVE ROLE IN THE SAFETY OF YOURSELF AND OTHERS.

### Parts and Accessories

When in need of replacement parts, oil, or accessories for your Yamaha Snowmobile, be sure to only use GENUINE YAMAHA PARTS, OIL, AND ACCESSORIES. Only genuine Yamaha parts, oil, and accessories are engineered to meet the standards and requirements of your Yamaha Snowmobile. For a complete list of accessories, refer to the current Yamaha Accessory Catalog. To aid in service and maintenance procedures on these snowmobiles, an Illustrated Parts Manual and a Service Manual are available through your local Yamaha Snowmobile dealer.

# Foreword

Congratulations! You have chosen a quality Yamaha Snowmobile designed and assembled to give dependable service. Be sure, as the owner/operator of a Yamaha Snowmobile, to become thoroughly familiar with its basic operation, maintenance, and off-season storage procedures. Read this manual and the accompanying Snowmobile Safety Handbook before operating the snowmobile to learn safe and proper use of your new Yamaha Snowmobile. Always operate the snowmobile within your level of skill and current terrain conditions.

The Operator's Manual, Snowmobile Safety Handbook, and Snowmobile Decals display the words Warning, Caution, and Note to emphasize important information. The symbol  **WARNING** identifies personal safety-related information. Be sure to follow the directive because it deals with the possibility of serious personal injury or even death. A **CAUTION** identifies unsafe practices which may result in snowmobile-related damage. Follow the directive because it deals with the possibility of damaging part or parts of the snowmobile. The symbol  **NOTE:** identifies supplementary information worthy of particular attention.

This manual covers operator-related maintenance, operating instructions, and off season storage instructions. If major repair or service is ever required, contact an authorized Yamaha Snowmobile dealer for professional service.

At the time of publication, all information and illustrations were technically correct. Some illustrations used in this manual are used for clarity purposes only and are not designed to depict actual conditions. Because Yamaha constantly refines and improves its products, no retroactive obligation is incurred.

This Operator's Manual should be considered a permanent part of the snowmobile and must remain with the snowmobile at the time of resale. If the snowmobile changes ownership more than once, contact your yamaha.

Every Yamaha Snowmobile meets or exceeds the standards of the Snowmobile Safety and Certification Committee and displays the SSCC decal. Yamaha endorses and encourages the safe use of all snowmobiles. Always wear a helmet and eye protection. Drive with caution, observe all state and local regulations, and respect the rights of others. ISMA members like Yamaha do their part to improve trails, sponsor events, and generally support the sport of snowmobiling. As a member of the National Snowmobile Foundation, Yamaha promotes snowmobiling through education, charity, and research programs.

© 2015 Yamaha

# General Information

## Snowmobile Identification

The snowmobile has two important identification numbers. The Vehicle Identification Number (VIN) is stamped into the tunnel near the right-side footrest and on a decal beneath the seat. The decal also displays pertinent production information. The Engine Serial Number (ESN) is stamped into the crankcase of the engine.

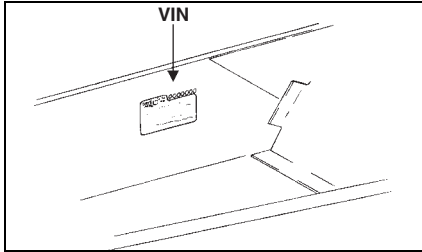

0726-383

These numbers are required by the dealer to complete warranty claims properly. No warranty will be allowed by Yamaha Inc. if the engine serial number or VIN is removed or mutilated in any way.

Always provide the snowmobile name, VIN, and ESN when contacting an authorized Yamaha Snowmobile dealer for parts, service, accessories, or warranty. If the complete engine must be replaced, ask the dealer to notify Yamaha for correct registration information.

## Control Locations

Shown are the typical control locations for Yamaha snowmobiles. Location of a specific control will vary according to model.

### SR10 Models

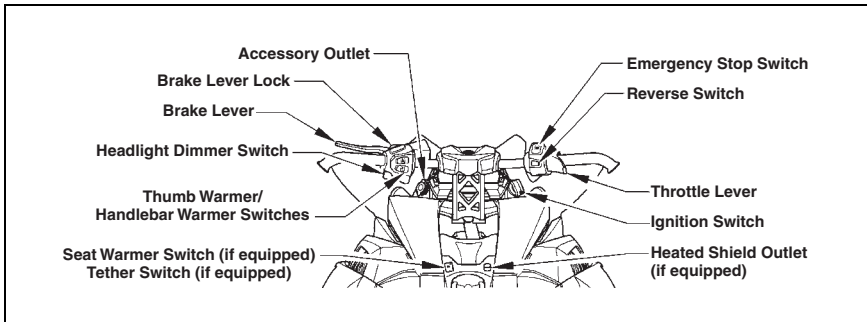

0749-256

### SR10 Long Track Models

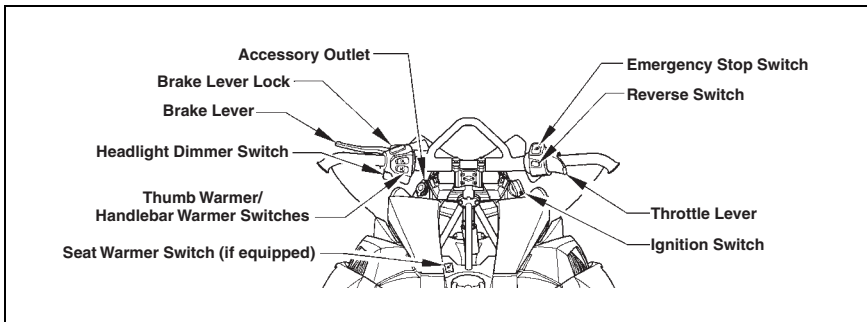

0749-257



## SR10SD46 Models

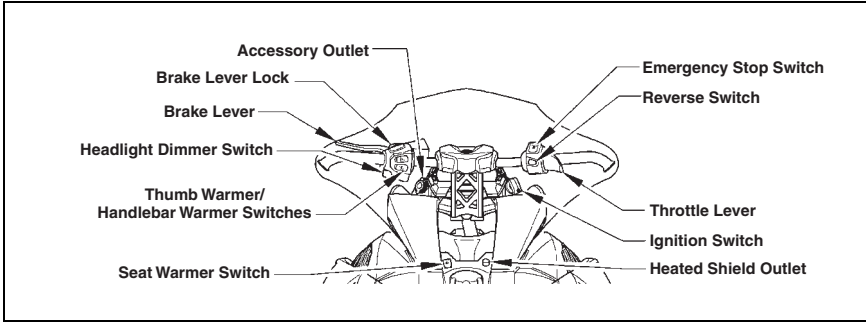

0749-258

### Gasoline-Oil

#### Recommended Gasoline

The recommended gasoline to use in these snowmobiles is RON 95 octane regular unleaded. In many areas, oxygenates are added to the gasoline. Oxygenated gasolines containing up to 10% ethanol are acceptable gasolines.

When using ethanol blended gasoline, it is not necessary to add a gasoline antifreeze since ethanol will prevent the accumulation of moisture in the fuel system.

#### Recommended Engine Oil

The recommended oil to use is Semi-Synthetic Yamalube 0W-30 oil.

#### CAUTION

**Any oil used in place of the recommended oil could cause serious engine damage**

After 800 km (500 miles) of operating, the engine oil must be changed and the oil filter replaced. The engine oil should be changed every 4000 km (2500 miles) before prolonged storage and the oil filter should be changed every 20,000 km (12,500 miles).

#### Filling Gas Tank

Since gasoline expands as its temperature increases, the gas tank must be filled to its rated capacity only. Expansion room must be maintained in the tank particularly if the tank is filled with cold gasoline and then moved to a warm area.

Also, if the snowmobile is to remain on a trailer after filling the gas tank, the bed of the trailer must be maintained level to prevent gasoline from draining out through the gas tank vent hose.

#### ⚠ WARNING

**Always fill the gas tank in a well-ventilated area. Never add gasoline to the snowmobile gas tank near any open flames or with the engine running. DO NOT SMOKE while filling the gas tank. Do not sit on the snowmobile without first installing the gas tank cap.**

The SR10SD46 features a 15.9 L (4.2 US gallon) auxiliary gas tank. A separate gas tank cap is located beneath the cowling just behind the operator seat. The auxiliary tank is plumbed directly into the main gas tank.



YM-126

#### Engine Break-In

The engine (when new or rebuilt) requires a short break-in period before the engine is subjected to heavy load conditions.

This engine does not require any pre-mixed fuel during the break-in period.

There is never a more important period in the life of the engine than the first 500 km (300 miles).

Since the engine is brand new, do not put an excessive load on it for the first 500 km (300 miles). The various parts in the engine wear and polish themselves to the correct operating clearances. During this period, prolonged full throttle operation or any condition that might result in engine overheating must be avoided.

Operating your snowmobile for the first time: Start the engine and let it idle for 15 minutes.

0-160 km (0-100 miles): Avoid prolonged operation above 6000 RPM.

160-500 km (100-300 miles): Avoid prolonged operation above 8000 RPM.

500 km (300 miles) and beyond: The snowmobile can now be operated normally.

■ **NOTE:** After 800 km (500 miles) of operation, the engine oil must be changed and the oil filter replaced. If any engine trouble should occur during the engine break-in period, immediately have a Yamaha dealer check the snowmobile.

## Drive Belt Break-In

Drive belts require a break-in period of 40 km (25 miles). Drive the snowmobile for 40 km (25 miles) at 3/4 throttle or less. By revving the engine up and down (but not exceeding 100 km/h [60 mph]), the exposed cord on the side of a new belt will be worn down. This will allow the drive belt to gain its optimum flexibility and will extend drive belt life.

■ **NOTE:** Before starting the snowmobile in extremely cold temperatures, the drive belt should be removed and warmed up to room temperature. Once the drive belt is at room temperature, install the drive belt.

## CAUTION

Never run the engine with the drive belt removed. Excessive revving of the engine could result in serious engine damage and drive clutch failure.

## Cold Drive-Away Function

There is a “cold drive-away” function incorporated within the engine.

■ **NOTE:** When cold-starting the engine, the coolant temperature warning icon will illuminate and the LOW TEMP display on the readout screen will begin to flash. With the engine in this temperature range, the RPM “limit” of the engine will be below drive system engagement speed. As the engine warms, the coolant temperature warning icon will begin to flash, the TEMP display will continue to flash, and the RPM “limit” of the engine will increase allowing the snowmobile to move without full-throttle operation. When the engine reaches proper operating temperature, the coolant temperature warning icon and the LOW TEMP display will go out.

## Speedometer/Tachometer/ Digital Gauge

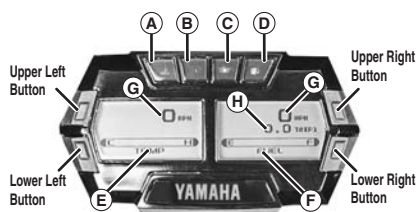

CWI-050A

## A. Coolant Temperature Indicator

The indicator and LOW TEMP display will cease to flash when the engine reaches proper operating temperature.

If the coolant temperature rises too far above proper operating temperature, the indicator will flash a warning (alert) and the engine will “surge” to alert the operator. If the coolant temperature rises to a critical point above proper operating temperature, the indicator will cease flashing and will remain constantly illuminated.

■ **NOTE: If the indicator is constantly on, the engine will shut off if vehicle speed is reduced to 1.5 km-h (0.9 MPH) or slower.**

### CAUTION

If the indicator is illuminated, stop the engine immediately and allow it to cool down. If unable to either determine or remedy the problem, take the snowmobile to an authorized Yamaha Snowmobile dealer for service. If not under warranty, this service is at the discretion and expense of the snowmobile owner.

## B. High Beam Indicator

The indicator is on whenever the high beam mode is selected by the headlight switch.

## C. Oil Pressure Indicator

The indicator relates to engine oil pressure, not the oil level; however, if the oil level is low, it may affect oil pressure. If oil pressure is lost, check the oil level (see page 22).

If the indicator does not go out or if the engine does not start, take the snowmobile to an authorized Yamaha Snowmobile dealer. If not under warranty, this service is at the discretion and expense of the snowmobile owner.

## D. Low Fuel Indicator

The indicator illuminates whenever the gas in the gas tank is low.

## E. Coolant Temperature/Battery Voltage/Intake Air Temperature

This bar display shows coolant temperature, battery voltage, and intake air temperature. Press the Lower Left Button to change which parameter is being displayed. Press and hold the Lower Left Button to see the actual values associated with the mode selected.

## F. Fuel Level Display

This display shows the approximate amount of gas remaining in the gas tank.

## G. RPM/Speed/Clock/Altimeter

Press the Upper Left Button to cycle the left screen between RPM and speed.

■ **NOTE: When RPM is displayed on the left screen, the right screen will display speed, clock, or altimeter. When speed is displayed on the left screen, the right screen will display RPM, clock, or altimeter.**

Press the Upper Right Button to cycle the right screen between speed, RPM, clock, and altimeter.

Press and hold the Upper Button on the speed-side of the gauge to shift the gauge between standard (MPH/miles/fahrenheit) and metric (km/h/kilometers/celsius) modes.

Press and hold the Upper Button on the RPM-side of the gauge to view maximum RPM. This value is reset each time the ignition key is turned off.

With the clock mode selected by pressing the Upper Right Button, press and hold the Upper Right Button to set the clock. The option of selecting the 12-hour or 24-hour clock is available; press the either Left Button to alternate between the two modes. Next, press the Lower Right Button to set the clock. Press either Left Button to set the hours; then press the Lower Right Button to set the minutes. Press either Left Button to set the minutes. When the proper time has been set, press the Lower Right Button to return to the main gauge display.

With the altimeter mode selected by pressing the Upper Right Button, press and hold the Upper Right Button to set the current altitude by using either Left Button. When the proper altitude has been set, press the Lower Right Button to return to the main gauge display.

## H. Engine Hour Meter/Odometer/Trip Meter/Clock

This display shows engine hours, odometer, trip meter, or clock. Press the Lower Right Button to change which parameter is being displayed. The Engine Hour Meter and Odometer cannot be reset. To reset the trip meter, select the Trip Meter; then press and hold the Lower Right Button until the trip meter display reads 0.

**NOTE: The clock can only be displayed in this position if it is not already being displayed in the main right screen. To set the clock when the clock is in this position, press and hold the Lower Right Button; then use the procedure found in G.**

## Diagnostic Codes

Diagnostic codes are activated by the ECM and may be displayed on the read-out screen for a number of reasons.

If a code is displayed while the engine is running, the ECM is receiving input that is outside of its established parameters. If a code has been activated, take the snowmobile to an authorized Yamaha Snowmobile dealer for service. If not under warranty, this service is at the discretion and expense of the snowmobile owner.

Refer to the following chart for diagnostic codes.

Code	Trouble
P0031	O2 Heater Control Circuit Low
P0032	O2 Heater Control Circuit High
P0107	Manifold absolute pressure circuit low
P0108	Manifold absolute pressure circuit high
P0112	Intake air temp sensor circuit low
P0113	Intake air temp sensor circuit high
P0115	Engine coolant temp sensor 1 circuit
P0117	Engine coolant temp sensor 1 circuit low
P0118	Engine coolant temp sensor 1 circuit high
P0120	Throttle position sensor circuit

Code	Trouble
P0122	Throttle position sensor circuit low
P0123	Throttle position sensor circuit high
P0130	O2 sensor circuit
P0131	O2 sensor circuit low
P0132	O2 sensor circuit high
P0171	System too lean
P0172	System too rich
P0201	Injector circuit/open - cylinder 1
P0202	Injector circuit/open - cylinder 2
P0203	Injector circuit/open - cylinder 3
P0217	Engine coolant over temp condition
P0261	Cylinder 1 injector circuit low
P0264	Cylinder 2 injector circuit low
P0267	Cylinder 3 injector circuit low
P0508	Idle air control system circuit low
P0509	Idle air control system circuit high
P0511	Idle air control circuit
P0522	Engine oil pressure sensor circuit low
P0523	Engine oil pressure sensor circuit high
P0562	System voltage low
P0563	System voltage high
P0780	Shift Error
P1315	Crankshaft Position out of sync
P1338	Crankshaft spike detected
P1339	Crankshaft tooth not detected
P1685	Main relay open circuit
P1686	Main relay circuit low
P1688	Reverse relay open circuit
P1689	Reverse relay circuit low
P1691	Forward relay open circuit
P1692	Forward relay circuit low
P1694	Headlight relay open circuit
P1695	Headlight relay circuit low
P2228	Barometric pressure sensor A circuit low
P2229	Barometric pressure sensor A circuit high
P2300	Ignition coil A primary control circuit low
P2303	Ignition coil B primary control circuit low
P2306	Ignition coil C primary control circuit low
U0155	Lost communication with the ECM

## Handlebar Tilt (Mountain Models)

1. Loosen the four cap screws and tilt the handlebar to the desired position.

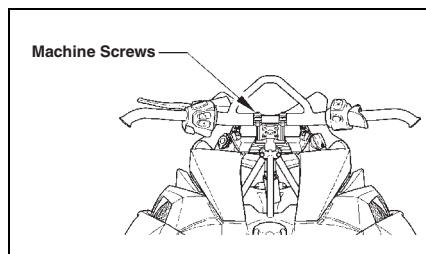

0748-905

2. Tighten the four cap screws evenly to 15 ft-lb.

### **⚠ WARNING**

**Tighten the cap screws according to specifications to prevent unexpected "movement" of the handlebar during operation over rough terrain. DO NOT position handlebar so steering (maximum right/left turning capabilities) or throttle and brake controls are affected.**

## Handlebar Tilt (SR10 Models)

The handlebar can be adjusted to the operator's preference. To adjust the handlebar, use the following procedure:

1. Remove the handlebar cover; then loosen the eight cap screws securing the handlebar caps to the riser and the riser to the steering post.

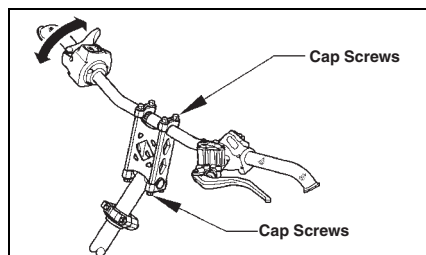

0747-828

2. Adjust the handlebar to operator's desired position, tighten the cap screws evenly to 2.0 kg-m (15 ft-lb), and check steering for maximum right/left turning capabilities.

### **CAUTION**

**Do not rotate the handlebar to a position that allows air to enter the brake system.**

### **⚠ WARNING**

**Tighten cap screws according to specifications to prevent unexpected "movement" of the handlebar during operation over rough terrain. DO NOT position the handlebar so steering (maximum right/left turning capabilities) or throttle and brake controls are affected.**

## Exhaust System

The exhaust system is designed to reduce noise and to improve the total performance of the engine. If any exhaust system component is removed from the engine and the engine is run, severe engine damage will result.

## Air-Intake Silencer

Used in conjunction with the fuel intake system is a specially designed air-intake silencer. The purpose of the silencer is to quiet the intake of fresh air. Since the fuel intake system is calibrated with the air-intake silencer in place, the engine must never be run with the silencer removed. Performance will not be improved if the air-intake silencer is removed. In contrast, severe engine damage will occur.

### **CAUTION**

**These snowmobiles are not designed to be operated in dusty conditions. Operating the snowmobile in dusty conditions will result in severe engine damage.**

## Cooling System

These snowmobiles are equipped with a closed liquid cooling system for engine cooling. The cooling system should be inspected daily for leakage and damage. Also, the coolant level should be checked daily. If leakage or damage is detected, take the snowmobile to an authorized Yamaha Snowmobile dealer for service. If not under warranty, this service is at the discretion and expense of the snowmobile owner.

When filling the cooling system, use an ethylene glycol-based coolant/water mixture which will satisfy the coldest anticipated weather conditions of your area in accordance with the coolant manufacturer's recommendations.

■ **NOTE:** If operating on ice or hard-packed snow conditions, it is recommended that Ice Scratchers be installed to reduce wear strip wear and engine overheating.

For checking/filling cooling system, refer to Coolant Level sub-section in the Maintenance section.

## Battery

It is extremely important that the battery be maintained at full charge at all times and that the battery connections be clean and tight. If charging the battery becomes necessary, refer to Battery sub-section in the Maintenance section.

### CAUTION

**Always turn the ignition switch key to the OFF position when the snowmobile is not being used. Leaving the ignition switch in the ON position will result in discharging the battery and possible damage to the battery.**

## Jump-Starting

■ **NOTE:** Yamaha does not recommend jump-starting a snowmobile with a dead battery but rather to remove the battery, service it, and correctly charge it; however, in an emergency, it may be necessary to jump-start a snowmobile. If so, use the following procedure to carefully and safely complete this procedure.

### ⚠ WARNING

**Improper handling or connecting of a battery may result in severe injury including acid burns, electrical burns, or blindness as a result of an explosion. Always remove rings and watches. Any time service is performed on a battery, the following must be observed: keep sparks, open flame, cigarettes, or any other flame away. Always wear safety glasses. Protect skin and clothing when handling a battery. When servicing a battery in an enclosed space, keep the area well-ventilated.**

■ **NOTE:** To access the battery, the seat must be removed.

1. For the snowmobile to be jump-started, slide any terminal boots away.
2. Inspect the battery for any signs of electrolyte leaks, loose terminals, or bulging sides. Leaking or bulging battery cases may indicate a frozen or shorted battery.

### ⚠ WARNING

**If any of these conditions exist, DO NOT attempt to jump-start, boost, or charge the battery. An explosion could occur causing serious injury.**

- Inspect the snowmobile to be used for jump-starting to determine if voltage and ground polarity are compatible. The vehicle must have a 12-volt DC, negative ground electrical system.

### CAUTION

**Always make sure the electrical systems are of the same voltage and ground polarity prior to connecting jumper cables. If not, severe electrical damage may occur.**

- Move the vehicle to be used for the jump-start close enough to ensure the jumper cables easily reach; then set and lock the brakes, shut off all electrical accessories, and turn the ignition switch OFF.

■ **NOTE: Make sure all switches on the snowmobile to be jump-started are turned OFF.**

- Disconnect all external accessories such as cell phones, GPS units, and radios on both vehicles.

### CAUTION

**Failure to disconnect electronic accessories during jump-starting may cause system damage due to power spikes.**

- Attach one clamp of the positive (red) cable to the positive (+) terminal (1) of the dead battery (C) being careful not to touch any metal with the other clamp; then attach the other clamp of the positive (red) cable to the positive (+) terminal (2) of the good battery (B).

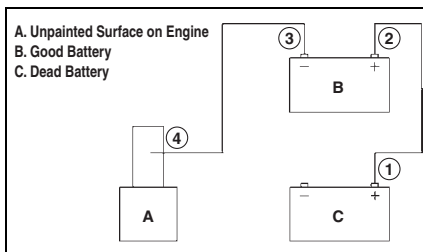

0744-527

■ **NOTE: Some jumper cables may be the same color but the clamps or ends will be color-coded red and black.**

- Attach one clamp of the negative jumper cable (black) to the negative (-) terminal (3) of the good battery (B); then attach the other clamp of the negative (black) jumper cable (4) to an unpainted metal surface (A) on the engine or frame well away from the dead battery and fuel system components.

### ⚠ WARNING

**Never make the final connection to a battery as a spark could ignite hydrogen gases causing an explosion of the battery resulting in acid burns or blindness.**

- Stand well away from the dead battery and start the vehicle with the good battery. Allow the vehicle to run for several minutes applying some charge to the dead battery.
- Start the snowmobile with the dead battery and allow it to run for several minutes before disconnecting the jumper cables.
- Remove the jumper cables in opposite order of hook-up (4, 3, 2, 1). Be careful not to short cables against bare metal.

■ **NOTE: Have the battery and electrical system checked prior to operating the snowmobile again.**

## Drive Clutch and Driven Clutch

The drive clutch and driven clutch do not require lubrication; therefore, no special maintenance is required by the snowmobile owner except for periodical cleaning.

However, the drive clutch and driven clutch should be disassembled, cleaned, and inspected by an authorized Yamaha Snowmobile dealer after every 4000 km (2500 miles) or seasonally, whichever occurs first. This service is at the discretion and expense of the snowmobile owner.

When operating the snowmobile at high altitudes, it may be necessary to change certain component parts of the drive clutch and/or the driven clutch. See an authorized Yamaha Snowmobile dealer for further information.

### CAUTION

**DO NOT attempt to service the drive clutch and driven clutch. The drive clutch and driven clutch must be serviced by an authorized Yamaha Snowmobile dealer only.**

## Drive Clutch/Driven Clutch Alignment

The alignment between the drive clutch and driven clutch is set at the factory. Normally, no adjustment is necessary as long as neither the drive clutch nor the driven clutch is removed or disassembled. However, if premature drive belt wear is experienced or if the drive belt turns over, the drive clutch/driven clutch alignment must be checked. Take the snowmobile to an authorized Yamaha Snowmobile dealer for this service. If not under warranty, this service is at the discretion and expense of the snowmobile owner.

## Fuel Pump

The fuel pump is designed to provide adequate amount of gas to the injectors at all throttle settings. If a fuel delivery problem is suspected, take the snowmobile to an authorized Yamaha Snowmobile dealer. If not under warranty, this service is at the discretion and expense of the snowmobile owner.

## Shock Absorbers (Rebuildable Gas)

Each shock absorber should be visibly checked weekly for fluid leakage, cracks or breaks in the body/reservoir, or a bent shaft. If any one of these conditions is detected, replacement or service is necessary. Take the snowmobile to an authorized Yamaha Snowmobile dealer for this service. If not under warranty, this service is at the discretion and expense of the snowmobile owner.

■ **NOTE: When the snowmobile is operated in extremely cold weather (-23°C/-10°F or colder), a small amount of leakage may be present. Unless the leakage is excessive, replacement is not necessary.**

■ **NOTE: The frequency of servicing rebuildable shock absorbers will vary according to the types of conditions and terrain the snowmobile has been subjected to. If riding quality deteriorates (or seems to be deteriorating), take the snowmobile to an authorized Yamaha Snowmobile dealer for shock absorber evaluation and/or servicing. This service is at the discretion and expense of the snowmobile owner.**

## Track/Track Studs

Accelerated wear strip and track clip wear caused by operating on ice or hard-packed snow conditions is NOT covered under Yamaha warranty policy.

■ **NOTE: If regularly operating on ice or hard-packed snow conditions, Performance Wear Strips may be installed at the expense of the snowmobile owner.**

In general, track life will be shortened when studs are installed. Drilling stud holes into the drive track will cut the internal fibers weakening the track. Avoid spinning the drive track. Studs may catch on an object and pull out of the track leaving tears and damage around the already weakened area. To minimize possible damage, consult your stud manufacturer for installation and stud pattern recommendations. Yamaha does not recommend studding a track.



## Paddle Track (On Equipped Models)

These models are equipped with a Power Claw style track which is specially designed for use in powder snow riding conditions. When the Power Claw track is operated in hard-packed snow conditions, it will run slightly slower than a standard track and it will accelerate wear strip wear. To decrease the amount of wear strip wear, slower speeds must be maintained when operating on hard-packed trails. Accelerated wear strip wear caused by operating a Power Claw track on hard-packed snow conditions is NOT covered under Yamaha warranty policy.

■ **NOTE:** If operating on ice or hard-packed snow conditions, it is recommended that Ice Scratchers be installed to reduce wear strip wear and engine overheating.

## Reverse Operation

The electrical reverse function offers the operator the convenience of being able to back up the snowmobile rather than having to turn the snowmobile around by hand. This feature, under most situations, should not be used to free a stuck snowmobile as it will tend to dig the skis deeper into the snow. Always use minimal speed when operating in reverse and come to a complete stop before shifting from either forward to reverse or reverse to forward.

## Shifting Into Reverse

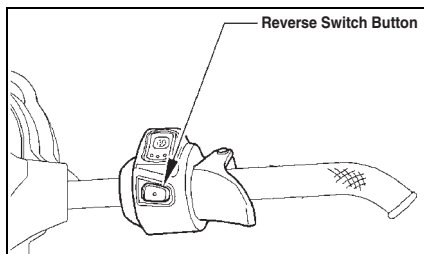

741-438A

■ **NOTE:** Correct drive belt tension (deflection) is important for the reverse function to operate properly. If the belt is too tight, difficulty in engaging reverse will be experienced.

1. Always warm up the engine for 2-3 minutes prior to shifting into reverse.
2. With the engine at idle (under 2500 RPM) and the snowmobile at a complete stop, press and release the reverse switch button.

■ **NOTE:** The snowmobile must be at a complete stop and the engine running under 2500 RPM before the system will allow shifting.

3. When reverse is engaged, a reverse icon will illuminate on the deluxe digital gauge and a reverse alarm will sound.

### CAUTION

Never shift into reverse while the snowmobile is moving forward as it is hard on the drive system.

## Operating in Reverse

### ⚠ WARNING

Use caution and minimal speed when operating the snowmobile in reverse. Be sure the button is in the desired position.

1. When shifting into reverse, always wait for the reverse icon to illuminate and the reverse alarm to sound before backing up.

■ **NOTE:** The reverse function is cancelled whenever the engine is shut off.

2. After shifting from reverse to forward (or from forward to reverse), apply the throttle slowly and evenly to allow the driven pulley to engage properly.

### CAUTION

After reversing in deep powder snow conditions, make sure the snowflap does not become "caught up" in the track. Track and/or snowflap damage may occur.

### CAUTION

If the snowmobile is equipped with ice scratchers, the scratchers must be disengaged or component damage will occur.

## Access Panel/Hood

To remove the access panel and hood, use the following procedure:

1. Remove the hairpin clip from the pin located at the front of the access panel. Remove the thumb screw securing the front left access panel to the front fascia. Move the panel up and off the pin; then swing the panel all the way out and unhinge the panel from the lower console.
2. Remove the torx-head screws securing the hood (located on the underside of the hood above the front tube of the upper A-arm); then remove the torx-head screws from the top-side of the hood securing the hood to the upper console and the torx-head screws from under the nosepiece of the hood.

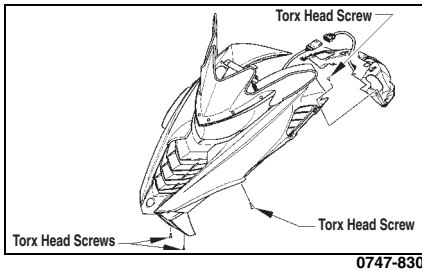

3. Remove the intake panel below the gauge; then locate the hood harness connector (located in front of the speedometer) and unplug the connector; then move the hood slightly forward and remove the hood.

To install the access panel and hood, use the following procedure:

1. Position the hood onto the snowmobile and connect the hood harness connector making sure the harness does not become pinched.
2. Secure the hood with torx-head screws and tighten securely.
3. Install the access panel onto the lower console; then close the access panel and secure with the hairpin clip. Install the intake panel.

## Removable Seat

To remove the seat, remove the torx-head screw from the underside of the seat; then lift on the back of the seat and move it up and rearward to remove it.

### CAUTION

**Prior to removing the seat, lift the rear of the seat and disconnect the seat heater harness connector.**

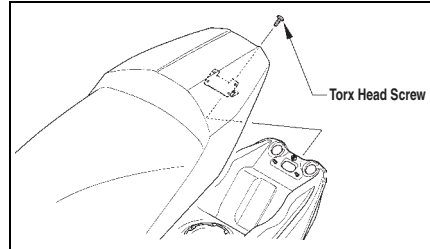

To install the seat, route the front tab on the seat through the seat-base hold-down bracket; then install the seat and secure using the torx-head screw.

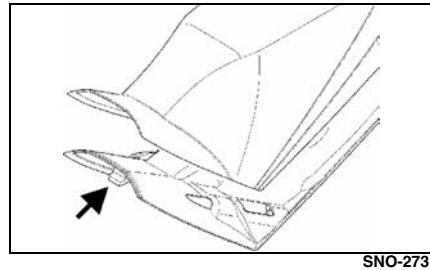

■ **NOTE:** Prior to lowering and securing the seat, connect the seat heater harness connector.

■ **NOTE:** On SR10SD46 models, pull back on the seat retainer pin and remove the seat. Make sure to disconnect the seat heater harness.

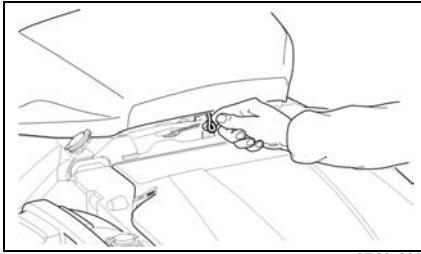

0748-419

## Towing

If the snowmobile is to be towed by another snowmobile, do not tow using the loops in the skis. The tow rope should be attached to the spindles.

# Operating Instructions

## Starting and Stopping Engine

It is imperative that the brake system be checked for wear and proper operation. After the engine has been started, check the headlights (high and low beam), taillight, and brakelight to be sure they are working properly and adjusted correctly. Make sure all lights are clean to provide maximum illumination. The headlight and taillight must be clean and must be illuminated whenever the engine is running.

### ⚠ WARNING

**Engine startup at ambient temperature below minus 30 °C is not guaranteed.**

### ⚠ WARNING

**Manual emergency startup of engine is not provided.**

1. Test the operation of the brake system by compressing the brake lever. The brake lever must feel firm when compressed; then while holding the brake lever in the compressed position, measure the distance between the brake lever and the handlebar. The distance must be greater than 2.54 cm (1 in.).

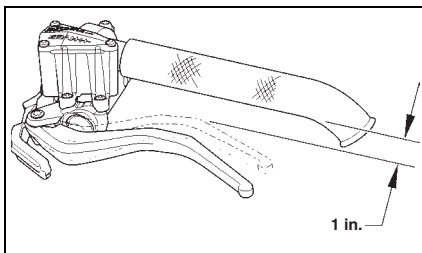

0745-816

2. With the brake fluid reservoir in a level position and the cover removed, check the fluid level. The brake fluid level must be at the high brake fluid mark in the reservoir.

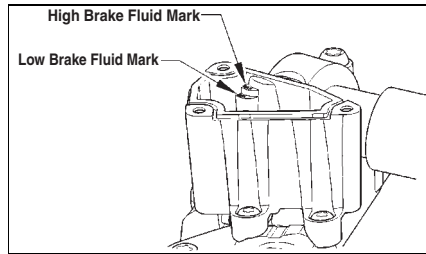

0745-817

3. If the brake fluid is below the high brake fluid mark, add Yamaha approved DOT 4 brake fluid until the fluid is at the recommended level. Install and secure the reservoir cover. Do not allow moisture to contaminate the brake system.

### CAUTION

**Brake fluid is highly corrosive. Do not spill brake fluid on any surface of the snowmobile.**

### ⚠ WARNING

**Do not overfill the brake fluid reservoir. Overfilling the reservoir may cause the brake system to hydraulically lock. Use only Yamaha approved brake fluid.**

### ⚠ WARNING

**Do not start the engine if the brake system is not functioning properly. Service the brake system or have it properly repaired prior to operating the snowmobile. Serious personal injury or even death may occur if the brake system is not operating properly.**

4. Test the throttle control lever by completely compressing and releasing it several times. The lever MUST return to the idle position quickly and completely.

### CAUTION

**Always check the coolant level before starting the engine.**

5. Move the emergency stop switch to the UP or RUN position.

6. Insert key into ignition switch; then rotate key to the RUN position.

■ **NOTE: Rotate the key to the START position; then when the engine starts, release the key.**

### CAUTION

**Do not continuously run the starter for more than 5 seconds at a time.**

■ **NOTE: When the engine starts, allow it to warm up properly. Idle the engine several minutes until the engine has reached normal operating temperature. Do not idle the engine for excessively long periods of time.**

7. There is a “cold drive-away” function incorporated within the engine. This function is active until the engine reaches operating temperature.
8. Flooding — If the engine does not start but seems ready to start, engage the brake lever lock; then compress the throttle control lever fully and try to start the engine. When the engine starts, release the throttle control lever immediately. After the warm-up, release the brake lever lock.
9. To shut off the engine, turn the ignition key to the OFF position or push the emergency stop switch to the DOWN position.

### CAUTION

**Always turn the ignition switch key to the OFF position when the snowmobile is not being used. Leaving the ignition switch in the ON position will result in discharging the battery and possible damage to the battery.**

## Braking

The following items are items that the operator must be familiar with when operating this snowmobile and its hydraulic brake system. Important additional information on the proper maintenance of the brake system is found in the Maintenance section.

1. Use the brakes wisely. Each time the brakes are applied in all hydraulic brake systems (including automotive applications), heat is transferred to the brake fluid. The amount of heat transferred during high speed stops and/or repetitive use may be high enough to boil the brake fluid and cause the brakes to either fade or may cause an unexpected loss of brakes. If this occurs, the brake fluid requires a cool-down period before the brakes will again function properly.

This cool-down period will vary depending upon the ambient air temperature and the temperature of the brake fluid. If loss of brakes has occurred because of high fluid temperatures, do not operate the snowmobile until the cool-down period has expired and brake lever firmness has returned.

### ⚠ WARNING

**Excessive, repetitive use of the hydraulic brake for high speed stops will cause overheating of the brake fluid and premature brake pad wear which will result in an unexpected loss of brakes.**

2. Be sure to maintain the brake fluid at the proper level and take care not to get any moisture in the system as moisture in the brake fluid lowers the boiling point. If the brake fluid is ever boiled (by high speed stops or repetitive use) or if moisture is allowed to enter the system, it must be changed. Never substitute or mix different types or grades of brake fluid.

### ⚠ WARNING

**Use only Yamaha approved DOT 4 brake fluid. Never substitute or mix different types or grades of brake fluid. Brake loss can result. Check brake fluid level and pad wear before each use. Brake loss can result in severe injury or even death.**

3. Never ride the brake. Even maintaining minimal pressure on the brake lever will cause the brake pads to drag on the disc and may overheat the brake fluid.

- The brake lever lock is not a parking brake and should not be applied for periods exceeding 5 minutes. NEVER OPERATE THE SNOWMOBILE WITH THE BRAKE LEVER LOCK ENGAGED.

**⚠ WARNING**

**The brake lever lock is not a parking brake and should not be applied for periods exceeding 5 minutes. The brake lever lock maintains the brake lever in the compressed position and maintains pressure against the brake disc; however, after a period of time, the pressure applied to the brake disc may relax below the amount required to hold the snowmobile stationary.**

- Pumping the brake lever is permissible; however, if pumping the brake lever more than twice is necessary to obtain the necessary stopping power, immediately take the snowmobile to an authorized Yamaha Snowmobile dealer for service. If not under warranty, this service is at the discretion and expense of the snowmobile owner.
- When new brake pads are installed, a “burnishing” process is required.

### Emergency Stopping

There are several methods of stopping or slowing the snowmobile under a variety of situations. Identified in the following chart are the ways a snowmobile may be brought to a stop and the effectiveness under normal conditions.

Item	Function
Emergency Stop Switch	interrupts ignition circuit
Throttle/Ignition Monitor Switch	interrupts ignition circuit
Ignition Switch	interrupts ignition circuit
Brake	slows the drive system
Tether	interrupts ignition circuit

### Throttle/Ignition Monitor Switch

The throttle control is equipped with a monitor switch for safety purposes which will stop the engine when a loss of return spring force occurs. If ice forms in the throttle system or if there is some other malfunction of the throttle system resulting in a loss of return spring force, the monitor switch will stop the engine when the throttle control lever is released.

**⚠ WARNING**

**If any malfunction of the throttle system occurs (such as freezing in fluffy snow) and the monitor switch does not shut off the engine, press down on the emergency stop switch IMMEDIATELY to stop the engine. DO NOT start the engine until the malfunction in the throttle system has been located and corrected.**

If the snowmobile engine stops abruptly when the throttle control lever is released and the activation of the monitor switch is suspected, use the following procedure:

- Rotate the ignition key to the OFF position.
- Remove ice and snow from the throttle system and wait 5-10 minutes for the engine heat to thaw ice from the throttle system.
- Test the throttle control lever by compressing and releasing it several times. The lever MUST return to the idle position quickly and completely.

■ **NOTE:** If the throttle control lever operates properly and the engine does not start, compress the throttle lever slightly (approximately 1/8 throttle) and try starting the engine. If the engine now starts and stops when the throttle lever is released, take the snowmobile to an authorized Yamaha Snowmobile dealer for service. If not under warranty, this service is at the discretion and expense of the snowmobile owner.

**⚠ WARNING**

**If the throttle control lever does not work properly, DO NOT ATTEMPT TO START THE ENGINE.**

4. If the throttle control lever operates properly, rotate the ignition key to the RUN position and go through normal starting procedures.

■ **NOTE:** If the throttle control lever operates properly and the engine does not start, a malfunctioning monitor switch may be the problem. Take the snowmobile to an authorized Yamaha Snowmobile dealer for service. If not under warranty, this service is at the discretion and expense of the snowmobile owner. However, if a dire emergency exists wherein the engine must be started, disconnect the throttle monitor switch located in the right-side handlebar control.

■ **NOTE:** If disconnection of the throttle monitor switch is needed to start the engine, take the snowmobile to an authorized Yamaha Snowmobile dealer for service as soon as possible. If not under warranty, this service is at the discretion and expense of the snowmobile owner.

**⚠ WARNING**

Under no circumstances should disconnection of the throttle control wiring harness be used as a substitute for the monitor switch during normal operation of the snowmobile. Personal injury and damage could occur if the throttle system malfunctions or if the operator is unable to stop the engine in an emergency. If the snowmobile must be operated with a disconnected throttle control wiring harness, **EXTREME CAUTION MUST BE TAKEN. NEVER EXCEED 10 MPH WITH THE THROTTLE CONTROL WIRING HARNESS DISCONNECTED.**

■ **NOTE:** The monitor switch is now bypassed. All other ignition/electrical features (ignition switch, emergency stop switch, headlight, taillight, and brakelight) will operate properly.

### Varying Altitude Operation

Operating a snowmobile at varying altitudes requires changes in performance components. These changes affect drive train components. Have a Yamaha dealer perform altitude-related service.

■ **NOTE:** Just as important as calibrating the snowmobile for higher altitudes is recalibrating the snowmobile when going to lower altitudes.

■ **NOTE:** Drive train changes can be made by the snowmobile owner if qualified to do so. If the owner does not feel qualified, take the snowmobile to an authorized Yamaha Snowmobile dealer for this service. This service is at the discretion and expense of the snowmobile owner.

# Lubrication

## Chain Case

### Checking Lubricant Level

■ **NOTE:** The snowmobile must be on a level surface for this procedure.

1. Check the lubricant level in the chain case by using the sight glass.

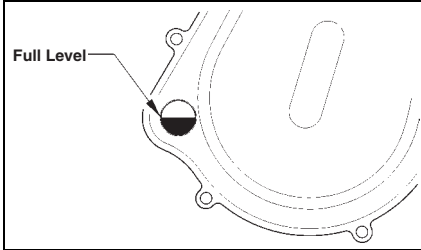

0746-115

■ **NOTE:** The correct level is when the lubricant is at least halfway up in the sight glass.

■ **NOTE:** Adding lubricant can be done by the snowmobile owner if qualified to do so. If the owner does not feel qualified, take the snowmobile to an authorized Yamaha Snowmobile dealer for this service. This service is at the discretion and expense of the snowmobile owner.

2. If the lubricant level is low, remove the three screws securing the shift actuator to the chain case, disconnect the actuator wiring harness, and remove the actuator w/extension, detent, and spring; then add appropriate amount of Synthetic Chain Lube through the shift actuator opening. When the lubricant is halfway up the sight glass, install the shift actuator w/extension, detent, and spring and connect the actuator wiring harness. Tighten screws to 0.4 kg-m (36 in.-lb).

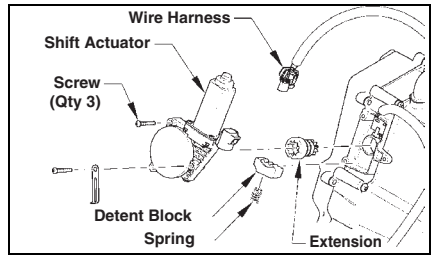

0748-259

### CAUTION

When installing the shift actuator, rotate the actuator back and forth to properly align it with the extension gear. Failure to do so could cause component damage.

3. Start the engine and verify proper reverse and forward operation by shifting in and out of reverse three times.

■ **NOTE:** If excessive build-up of moisture or discolored oil is detected in the chain case, it may be necessary to replace the lube.

### Replacing Lubricant

■ **NOTE:** Replacing the lubricant can be done by the snowmobile owner if qualified to do so. If the owner does not feel qualified, take the snowmobile to an authorized Yamaha Snowmobile dealer for this service. This service is at the discretion and expense of the snowmobile owner.

■ **NOTE:** The side panels, hood, and exhaust resonator must be removed for this procedure.

1. Place a drain pan under the chain case; then loosen the eleven screws securing the chain case cover/oil tank assembly to the chain case housing starting with the bottom screws first.

■ **NOTE:** It is critical that the snowmobile is on a level surface to ensure the lubricant drains properly and completely.

■ **NOTE:** Inspect the chain case cover seal for nicks or damage.



2. When the lubricant has completely drained from the case and the chain case is cleaned of old oil, install the chain case cover. Tighten the cap screws to 1.65 kg-m (12 ft-lb).
3. Remove the three screws securing the shift actuator to the chain case, disconnect the actuator wiring harness, and remove the actuator w/ extension, detent, and spring. Pour the recommended chain lubricant through the shift actuator opening until the lubricant is at least halfway up in the sight glass; then install the shift actuator w/extension, detent, and spring and connect the actuator wiring harness.

■ **NOTE:** Make sure the reverse sensor wire is routed up so the wires do not become pinched between the actuator and the case.

#### **CAUTION**

**When installing the shift actuator, rotate the actuator back and forth to properly align it with the extension gear. Failure to do so could cause component damage.**

4. Install and secure the exhaust resonator.
5. Start the engine and verify proper reverse and forward operation by shifting in and out of reverse three times.

#### **CAUTION**

**The correct lubricant to use in the chain case is Synthetic Chain Lube. Any substitute may cause serious damage to the drive system.**

### **Rear Suspension**

This procedure should be done every 40 operating hours.

■ **NOTE:** Yamaha recommends that **All-Temp Grease** be used for this procedure.

1. Using Handlebar Stand or Steering Post Stand or a suitable substitute, lay the snowmobile on its left side.
2. Lubricate all grease fittings with all-temperature grease.

# Maintenance

Periodic Maintenance Checklist			
Item	Interval	Page	Remarks
Brake System	Daily	28	Check for binding, leakage, and proper operation; lever firmness, travel, caliper, disc, and pads
Cooling System - Liquid	Daily	9,24	Check for leakage, damage, obstructions, coolant level
Engine Oil	Daily	22	Check oil level and for signs of leakage
Engine Oil - Initial	800 km (500 Mi)	22	Change oil
Engine Oil - After Initial	4000 km (2500 Mi)	22	Change oil
Engine Oil Filter - Initial	800 km (500 Mi)	22	Change filter
Engine Oil Filter - After Initial	20000 km (12500 Mi)	22	Change filter
Battery	Daily	9,25	Check for proper charge and tight connections
Stop Switch	Daily	—	Check for proper operation
Hoses	Daily	—	Check for damage, leakage, and wear
Headlight & Taillight/Brake-light	Daily	38-39	Check for proper operation and cleanliness
Steering System	Daily	—	Check for proper operation, tightness of bolts, and binding
Throttle Control System	Daily	17	Check for binding, sticking, proper operation, throttle cable tension, and wear
Drive Belt	Daily Monthly	31	Check for wear, cracks, and fraying Check length and width dimensions
Ski Wear Bars	Daily	39	Check for wear and damage
Electrical Wiring	Weekly	—	Check for wear, damage, and tight connections
Exhaust System	Weekly	8	Check for damage, leakage, and obstructions
Nuts, Bolts, Fasteners	Weekly	—	Check tightness
Shock Absorbers	Weekly	11,35	Check for fluid leakage and damage and air pressure (Fox Air Shocks)
Spark Plugs	4000 km (2500 Mi)/ Seasonal	24	Check center electrode insulator color, carbon, and gap
Valve Clearance	40000 km (25000 Mi)	25	Check/adjust
Crankcase Breather System	Seasonal	—	Check breather hose for cracks or damage and replace as necessary
Suspension	Weekly	35	Check for damage, loose components, and proper adjustment
Track Tension/Alignment	Weekly	33,34	Check/adjust as necessary
Wear Strips	Weekly	41	Check for wear and damage
Wires & Cables	Weekly	—	Check for wear, damage, and fraying
Fuel System - Tank, Pump, & Vent Hose	Weekly	—	Check for damage, wear, obstructions, and leakage
Chain Case	Daily	19	Check lube level and for leakage
Chain Case - Lubricant	Seasonal	19	Replace
Drive Chain Tension - Initial	500 km (300 Mi)	31	Check tension and adjust as necessary
Drive Chain Tension - After Initial	800 km (500 Mi)	31	Check tension and adjust as necessary
Heat Exchangers	Monthly	—	Check for wear, leakage, and damage
Drive Clutch/Driven Clutch	4000 km (2500 Mi)/ Seasonal	10,11	Check for damage, binding, and wear/remove drive belt, clean drive clutch/driven clutch
Rear Suspension	Monthly	20	Grease

The longevity and safety of the snowmobile can be increased by making periodic checks of the items in the preceding checklist.

If, at any time, abnormal noises, vibrations, or improper working conditions of any component of this snowmobile are detected, **DO NOT OPERATE THE SNOWMOBILE**. Take the snowmobile to an authorized Yamaha Snowmobile dealer for inspection and adjustment or repair. If not under warranty, this service is at the discretion and expense of the snowmobile owner.

The snowmobile should be taken to an authorized Yamaha Snowmobile dealer at the end of each snowmobiling season for general inspection and for off-season storage servicing. This inspection and servicing is at the expense of the snowmobile owner.

## Fuel System

### ⚠ WARNING

**Whenever any maintenance or inspection is made on the fuel system in which there may be fuel leakage, there should be no welding, smoking, open flames, etc., in the area.**

## Gasoline Additives

Fuel de-icer can be used for all models. Yamaha Fuel Stabilizer should also be added to the last tank of gasoline before storage.

## Fuel Pickup Valves

If ever there is a restricted fuel flow and a pickup valve is suspected, take the snowmobile to an authorized Yamaha Snowmobile dealer for this service. If not under warranty, this service is at the discretion and expense of the snowmobile owner.

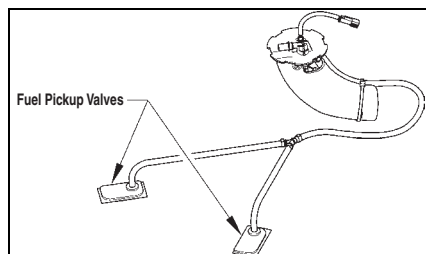

0747-833

## Checking Engine Oil Level

■ **NOTE:** The snowmobile must be on a level surface for this procedure.

### CAUTION

**If the engine and oil are not at operating temperature, the oil will not read correctly on the oil level stick.**

1. Start the engine and let it idle and warm up until the fan on the radiator turns on, or if the snowmobile was operated, allow the engine to idle for approximately 30 seconds.

### CAUTION

**Immediately after the engine is started, check that the oil pressure warning light goes out.**

2. Shut the engine off; then allow the engine to cool. Remove the oil level stick from the oil tank and verify it is within the "NORMAL" range on the stick.

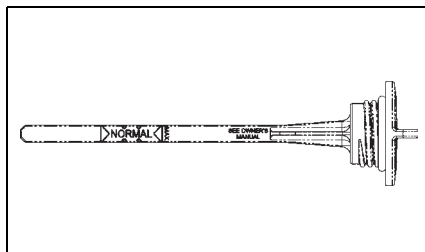

SNO-482

3. If step 1 and 2 was followed and the oil level is not within the "NORMAL" range, add the recommended engine oil.

■ **NOTE:** Care must be taken not to over-fill the oil tank.

## Changing Engine Oil/Filter

### ⚠ WARNING

**Engine oil is extremely hot immediately after the engine is turned off. Burning could occur if oil contacts skin or clothing.**

■ **NOTE:** Recycle or properly dispose of the used engine oil.

■ **NOTE:** The access panels and hood must be removed for this procedure.

1. Park the snowmobile on a level surface; then start the engine and let it idle and warm up until the fan on the radiator turns on, or if the snowmobile was operated, allow the engine to idle for approximately 30 seconds. Shut the engine off.
2. Remove the torx-head screws and the rear access plate from beneath the snowmobile.
3. Place a drain pan beneath the engine oil drain screw; then remove the screw and allow the oil to drain completely.



XM125A

4. Using Oil Filter Wrench, loosen (but do not remove) the oil filter and allow the oil to drain from the filter into the drain pan; then remove the filter.
5. Apply a light coat of fresh engine oil to the seal of the new oil filter.
6. Install the new oil filter by turning the oil filter by hand until the seal has contacted the oil filter mounting surface; then tighten the oil filter to 1.7 kg-m (12 ft-lb).
7. Install the engine oil drain screw with a new gasket. Tighten the screw to 1.0 kg-m (7.2 ft-lb).
8. Remove the four torx-head screws securing the right-side footrest to the tunnel and the support; then with a drain pan in position, remove the drain plug from the oil tank.

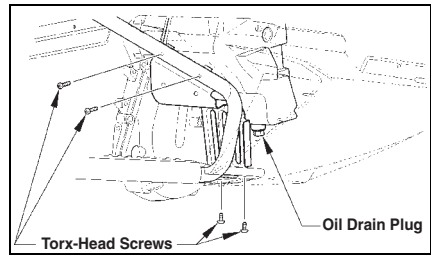

746-121A

■ **NOTE:** To aid in draining the oil from the tank, position a funnel between the tank and the opening of the tunnel running board.

9. After the oil has drained completely, install the drain plug with a new O-ring and tighten to 2.2 kg-m (16 ft-lb).
10. Pour 2.8 L (3 US quarts) of engine oil into the oil tank.
11. Without starting the engine, place the handlebar emergency stop switch to the RUN position and the ignition switch to the ON position. The Oil Pressure Warning Icon should illuminate.

■ **NOTE:** If the warning icon does not illuminate, take the snowmobile to an authorized Yamaha Snowmobile dealer for service. If not under warranty, this service is at the discretion and expense of the snowmobile owner.

12. If the warning icon illuminates (from step 11), start the engine. The warning icon should go out within five seconds. If it does, proceed to step 13.

■ **NOTE:** If the warning icon does not go out, shut the engine off immediately and repeat step 11; then place the ignition switch to the ON position and repeat step 12. If the warning icon does not go out, take the snowmobile to an authorized Yamaha Snowmobile dealer for service. If not under warranty, this service is at the discretion and expense of the snowmobile owner.

13. Shut the engine off; then allow the engine to cool. Remove the oil level stick from the oil tank and verify it is within the “NORMAL” range on the stick.

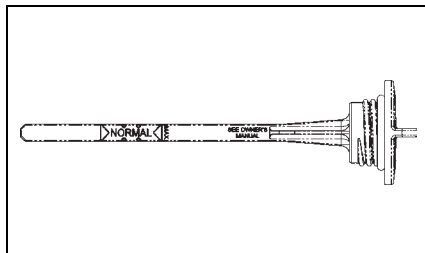

SNO-482

■ **NOTE:** If the oil and engine are not at operating temperature, the oil level may read too low. Always make sure the engine is at operating temperature before checking the oil.

14. Install the access plate and torx-head screws beneath the snowmobile; then install the hood and access panels.

## Coolant Level

■ **NOTE:** Use a good quality, ethylene glycol-based, automotive-type coolant.

### ⚠ WARNING

Always check the coolant level with the engine cold.

Locate the filler neck located above the resonator; then remove the coolant cap from the filler neck. Verify that the coolant is at the bottom of the tab in the filler neck.

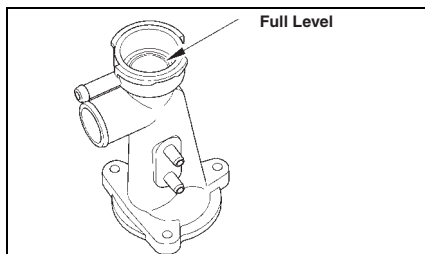

0747-547

Locate the coolant tank above the drive clutch; then remove the plug from the coolant tank. Add coolant to the full level on the tank. Install the plug.

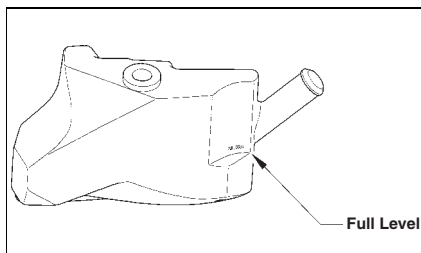

0747-766

### CAUTION

If the coolant is below the neck and if coolant has been added, immediately inspect for leakage and/or damage. If leakage or damage is detected, take the snowmobile to an authorized Yamaha Snowmobile dealer for service. If not under warranty, this service is at the discretion and expense of the snowmobile owner.

## Spark Plugs

■ **NOTE:** Always use the recommended spark plugs in the engine. See the appropriate specifications sheet for correct spark plug gap.

### CAUTION

If adjusting spark plug gap is necessary, do not use the center electrode as a leverage point. Damage to the plug may occur.

1. Disconnect the main harness from the ignition coils; then remove the ignition coils from the cylinder head cover.
2. Remove the three spark plugs.

■ **NOTE:** Prior to installing the spark plugs, check the gap between the electrode and ground strap. The clearance should be 0.7-0.8 mm (0.028-0.031 in.).

3. Install new spark plugs. Tighten to 1.3 kg-m (9.4 ft-lb).
4. Install the ignition coils onto the cylinder head cover making sure they are fully seated. Connect the main harness to the ignition coils.
5. Install the hood and access panels.

## Checking/Adjusting Valve Clearance

After 40,000 km (25,000 miles), valve clearance should be checked and adjusted as necessary.

■ **NOTE:** Take the snowmobile to an authorized Yamaha Snowmobile dealer for inspection and service. This service is at the discretion and expense of the snowmobile owner.

### CAUTION

It is critical that the checking/adjusting valve clearance be done at the recommended intervals or severe engine damage may occur.

## Battery

These sealed batteries after being in service require regular cleaning and charging in order to deliver peak performance and maximum service life. The following procedure is recommended for cleaning and maintaining sealed batteries. Always read and follow instructions provided with battery chargers and battery products.

■ **NOTE:** Battery maintenance may be done by the snowmobile owner if qualified to do so. If the owner does not feel qualified, take the snowmobile to an authorized Yamaha Snowmobile dealer for this service. This service is at the discretion and expense of the snowmobile owner.

### ⚠ WARNING

Improper handling or connecting of a battery may result in severe injury including acid burns, electrical burns, or blindness as a result of an explosion. Always remove rings and watches. Any time service is performed on a battery, the following must be observed: keep sparks, open flame, cigarettes, or any other flame away. Always wear safety glasses. Protect skin and clothing when handling a battery. When servicing a battery in an enclosed space, keep the area well-ventilated.

### ⚠ WARNING

Battery posts, terminals, and related accessories contain lead and lead compounds, chemicals known to the state of California to cause cancer and reproductive harm. Wash hands after handling.

1. Remove the torx-head screw from the rear underside of the seat; then remove the seat.

### CAUTION

Make sure to disconnect the seat heater harness connector prior to removing the seat.

2. Remove the negative battery cable and ground wire; then remove the positive cable.

■ **NOTE:** For installing purposes prior to removing the battery, note the routing and securing locations of the cables and harness wires.

3. Remove the two screws and lock nuts securing the battery bracket/solenoid to the seat-base; then move the bracket up and out of the way and remove the battery.

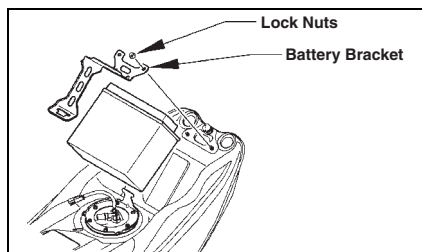

0747-528

### ⚠ WARNING

Avoid spillage and contact with skin, eyes, and clothing.

### CAUTION

Do not charge the battery while it is in the snowmobile with the battery terminals connected.

4. Thoroughly wash the battery with soap and water; then using a wire brush, clean the battery posts and cable ends removing all corrosive buildup. Replace damaged cables or cable ends.

■ **NOTE:** If battery posts or cable ends have a build-up of white/green powder residue, apply water and baking soda to neutralize acid; then flush off with warm soapy water.

**CAUTION**

**Do not remove seal strip on a sealed battery.**

**⚠ WARNING**

**Battery acid is harmful if it contacts eyes, skin, or clothing. Care must be taken whenever handling a battery.**

5. Using a multimeter, test the battery voltage. The meter must read no less than 12.5 DC Volts for a fully charged battery.

■ **NOTE:** At this point if the meter reads as specified, the battery may be returned to service (see step 9).

6. If the meter reads less than specified voltage, charge the battery using the following guidelines.

A. When using an automatic battery charger, always follow the charger manufacturer's instructions.

B. When using a constant-current battery charger, use the following Battery Charging Chart.

<b>Battery Charging Chart (Constant-Current Charger)</b>		
<b>Battery Voltage (DC)</b>	<b>Charge State</b>	<b>Charge Time Required (at 1.5-2.0 Amps)</b>
12.5 (minimum)	100%	None
12.2-12.4	75%-99%	3-6 hours
12.0-12.2	50%-74%	5-11 hours
11.0-11.9	25%-49%	13 hours (minimum)
11.5 or less	0-24%	20 hours (minimum)

■ **NOTE:** If the battery voltage is 11.5 DC Volts or less, some chargers may “cut off” and fail to charge. If this occurs, connect a fully charged booster battery in parallel (positive to positive and negative to negative) for a short period of time with the charger connected. After 10-15 minutes, disconnect the booster battery leaving the charger connected and the charger should continue to charge. If the charger “cuts off,” replace the battery.

7. After charging the battery for the specified time, remove the battery charger and allow the battery to sit for 1-2 hours.

8. Connect the multimeter and test the battery voltage. The meter should read no less than 12.5 DC Volts. If the voltage is as specified, the battery is ready for service.

■ **NOTE:** If voltage in step 8 is below specifications, charge the battery an additional 1-5 hours; then retest. The battery is ready for service.

9. Place the battery into position in the snowmobile; then coat the battery posts and cable ends with a light coat of multi-purpose grease.

**CAUTION**

**Never exceed the standard charging rate.**

**⚠ WARNING**

**An overheated battery could explode causing severe injury or death. Always monitor charging times and charge rates carefully. Stop charging if the battery becomes very warm to the touch. Allow it to cool before resuming charging.**

**CAUTION**

**Before installing the battery, make sure the ignition switch is in the OFF position.**

10. Secure the red positive cable to the positive terminal on the battery using a cap screw, lock washer, and a flat washer. Tighten securely.
11. Secure the main black negative cable and the small black negative cable to the battery using a cap screw, lock washer, and a flat washer. Tighten securely.

### CAUTION

**Connecting cables in reverse (positive to negative and negative to positive) can cause serious damage to the electrical system.**

■ **NOTE:** Assure the harness wires and cables are routed properly as noted during removing battery procedure.

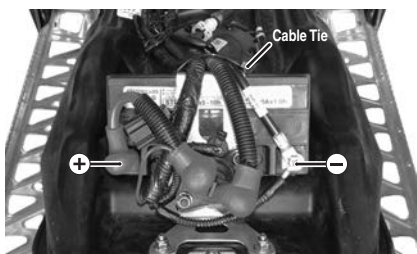

12. Install the battery bracket/solenoid and tighten the two screws and lock nuts to 1.2 kg-m (105 in.-lb); then install the seat and secure with the torx-head screw. Tighten securely.

■ **NOTE:** Prior to lowering and securing the seat, connect the seat heater harness connector.

## Fuses

Fuses protect the snowmobile electrical system from overloading. If electrical parts in the snowmobile are not working, the system may have been overloaded and caused a blown fuse. Before repairing or replacing any electrical part, check the appropriate fuses. If a fuse blows (opens a circuit), all the parts of the snowmobile that use that circuit will not work.

Once which fuse to check has been determined, perform the following steps:

1. Locate the fuse block and remove the fuse block cover.

■ **NOTE:** The fuse block is behind the coolant overflow bottle.



■ **NOTE:** There are spare fuses beneath the fuse block cover.

2. Remove the suspected fuse.

■ **NOTE:** Fuse function descriptions are next to the fuse contacts in the fuse block.

3. Look through the clear side of the fuse to see if the element inside is burned or separated. If it is, the fuse is blown and should be replaced with a fuse of the correct amperage rating.

### ⚠ WARNING

**Always replace a fuse with one having the same specified amperage rating. Using a fuse with a higher rating can cause severe wire damage and could start a fire.**

4. Install the fuse block cover and close the access panel.

Even after replacing a fuse, it may continue to blow if the cause of the overload is not determined. If the fuse continues to blow, take the snowmobile to an authorized Yamaha Snowmobile dealer for service. If not under warranty, this service is at the discretion and expense of the snowmobile owner.



## Brake System

Yamaha recommends that the brake system (brake lever, fluid reservoir, hose, caliper, pads, and brake disc) be checked daily for fluid leakage, wear, or damage and for proper operation. Also, the brake fluid level must be checked every time before starting the engine.

### ⚠ WARNING

**DO NOT operate the snowmobile when the brake lever lock is engaged or when any component in the brake system is damaged, worn, or adjusted improperly. If the snowmobile is operated and the brake system is not functioning properly, severe personal injury could result.**

### Checking/Adding Brake Fluid

1. With the brake fluid reservoir in a level position and the cover removed, check the fluid level. The brake fluid level must be at the high brake fluid mark in the reservoir.

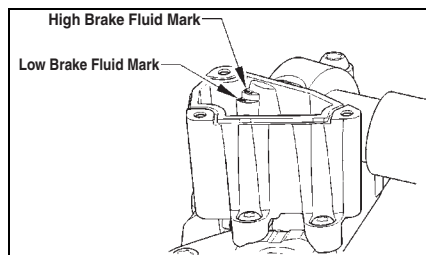

745-817A

2. If the brake fluid is below the high brake fluid mark, add Yamaha approved DOT 4 brake fluid until the fluid is at the recommended level. Install and secure the reservoir cover. Do not allow moisture to contaminate the brake system.

### CAUTION

**Brake fluid is highly corrosive. Do not spill brake fluid on any surface of the snowmobile.**

### ⚠ WARNING

**Do not overfill the brake fluid reservoir. Overfilling the reservoir may cause the brake system to hydraulically lock. Use only Yamaha approved DOT 4 brake fluid. Never substitute or mix different types or grades of brake fluid. Brake loss can result. Brake loss can result in severe injury or even death.**

### Changing Brake Fluid

The brake fluid must be changed on a regular basis and whenever the brake fluid has been overheated or contaminated. The brake fluid should be changed every 1600 km (1000 miles) or at the end of the snowmobiling season, whichever occurs first. Take the snowmobile to an authorized Yamaha Snowmobile dealer for this service. This service is at the discretion and expense of the snowmobile owner.

### Checking Brake Lever Travel

Before each use, check the brake lever travel using the following procedure:

1. Compress the brake lever fully.

■ **NOTE: Do not pump the brake lever as it will produce an inaccurate reading.**

2. Measure the distance between the brake lever and the handlebar. The distance must be greater than 2.54 cm (1 in.).

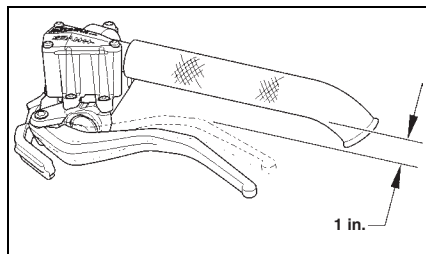

0745-816

3. If the resultant distance is less than specified, take the snowmobile to an authorized Yamaha Snowmobile dealer for service. If not under warranty, this service is at the discretion and expense of the snowmobile owner.

### **⚠ WARNING**

**Do not operate the snowmobile if the compressed distance between the brake lever and the handlebar is less than 2.54 cm (1 in.). Brake loss may occur. Brake loss can result in severe personal injury.**

### **Bleeding Brake System**

If the brake lever feels spongy when applied, the brake system may need to be bled. To bleed the brake, use the following procedure:

■ **NOTE:** The brake system may be bled by the snowmobile owner if qualified to do so. If the owner does not feel qualified, take the snowmobile to an authorized Yamaha Snowmobile dealer for this service. This service is at the discretion and expense of the snowmobile owner.

1. Remove the reservoir cover and (if necessary) fill the reservoir to the high brake fluid mark with Yamaha approved DOT 4 brake fluid.

### **CAUTION**

**Brake fluid is highly corrosive. Do not spill brake fluid on any surface of the snowmobile.**

### **⚠ WARNING**

**Use only Yamaha approved DOT 4 brake fluid. Any substitute may result in a loss of brakes.**

2. Slide a piece of flexible tubing over the ball of the bleeder valve and direct the other end into a container.

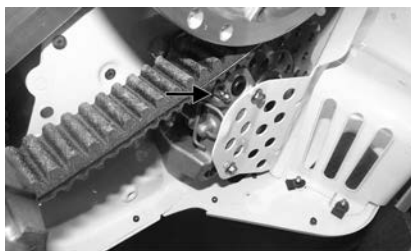

3. Slowly compress the brake lever until maximum pressure is attained; then hold the lever in the compressed position to maintain pressure. Open the bleeder valve to release the fluid and air. When the fluid stops, close the bleeder valve; then release the brake lever.

4. Repeat step 3 until the brake fluid flows free of air bubbles.

■ **NOTE:** It may be necessary to refill the reservoir during the bleeding process. Never allow the brake fluid to go below the low brake fluid mark in the reservoir.

5. When the brake fluid is free of all air and the brake lever feels firm when compressed, fill the reservoir to the high brake fluid mark; then install and secure the cover. Remove the tube from the bleeder valve.

### **Checking/Changing Brake Pads**

The condition of the brake pads must be checked daily and changed if worn or damaged. To check and change the brake pads, use the following procedure:

■ **NOTE:** The brake pads may be changed by the snowmobile owner if qualified to do so. If the owner does not feel qualified, take the snowmobile to an authorized Yamaha Snowmobile dealer for this service. This service is at the discretion and expense of the snowmobile owner.

■ **NOTE:** When installing new brake pads, always install them as a set. Never install just one pad or use brake pads which have been used in another snowmobile.

1. Remove the brake fluid reservoir cover; then remove most of the brake fluid from the reservoir. Install the cover.

### CAUTION

**Brake fluid is highly corrosive. Do not spill brake fluid on any surface of the snowmobile.**

■ **NOTE:** The above procedure will allow room for the fluid from the caliper when the pistons are pushed into the caliper for installing new brake pads. Replacing the cover will prevent fluid spillage.

2. Open the left-side access panel.
3. Remove the torx-head screws securing the brake shield to the belt guard mount; then remove the cap screws securing the brake shield to the brake caliper.
4. Carefully move the shield out of the way; then remove the hairpin clip securing the brake pads to the caliper assembly.
5. Using a pair of pliers, pull the outer brake pad out of the caliper assembly.



PC013

■ **NOTE:** Changing one pad at a time will prevent one piston from pushing out the other piston from the caliper.

6. Measure the thickness of the brake pad. The brake pad thickness must be greater than 1.0 mm (0.04 in.). If the brake pad thickness is less than specified, replacement of both pads is necessary.

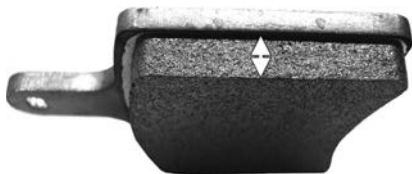

PC011A

7. Using a flat-blade tool, slowly and carefully push the piston into the caliper.
  8. Position the outer brake pad into the caliper; then install the hair-pin clip into the caliper assembly.
  9. Repeat steps 5-8 for the inner pad; then secure the pad with the hairpin clip.
  10. Remove the reservoir cover and remove the remaining fluid; then fill the reservoir with fresh fluid and install the cover.
  11. Pump the brake lever to ensure correct positioning of the brake pads and proper brake lever travel; then release.
- **NOTE:** If brake lever travel is not within specification, bleed the brake system.
12. Remove the reservoir cover and fill the reservoir (if necessary) to the proper level with fresh brake fluid; then install the cover.
  13. Secure the brake shield, the driven clutch (tightened to 20 ft-lb), and the rear belt guard; then close and secure the left-side access panel.

■ **NOTE:** When new brake pads are installed, a “burnishing” process is required (see Burnishing Brake Pads sub-section).

### Burnishing Brake Pads

After changing brake pads, the new brake pads must be burnished to achieve full braking effectiveness. Braking distance will be extended until brake pads are properly burnished.

To properly burnish the brakes, use following procedure:

1. Choose an area sufficiently large to safely accelerate to 50-65 km/h (30-40 mph) and to brake to a stop.

■ **NOTE:** This procedure can also be accomplished using a shielded jack stand.

2. Accelerate to 50-65 km/h (30-40 mph); then compress brake lever to decelerate to a stop.

■ **NOTE:** Lightly apply the brake lever to come to an easy stop; do not over-apply brakes or “lock up” the track.

3. Repeat procedure 10-15 times allowing some cooling between stops.

■ **NOTE:** Do not repeat too soon or too aggressively as to get the brake disc “red hot.”

**⚠ WARNING**

**Do not attempt sudden stops or put yourself into a situation where a sudden stop will be required until the brake pads are properly burished.**

■ **NOTE:** This procedure stabilizes the pad material and extends the life of the pads.

## Chain Tension

1. Remove the shroud, right-side cover, and exhaust assembly.
2. Loosen the jam nut.
3. Turn the chain tension adjustment bolt clockwise until it is finger tight; then loosen it 1 1/2 turns.

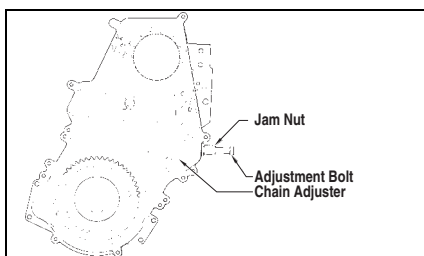

4. While holding the bolt with a wrench, tighten the jam nut to 2.5 kg-m (18 ft-lb).

5. Install the exhaust assembly with a new gasket.

6. Install the right-side cover and the shroud.

■ **NOTE:** Check that the harness is installed correctly.

## Drive Belt

The drive belt transfers power from the drive clutch to the driven clutch. If the belt is worn, cracked, or stretched, maximum power will not be transmitted and the belt could also fail and therefore must be replaced. Periodic checks (at least once a month under normal usage) of two drive belt specifications are essential.

1. Measure the outside circumference of the drive belt. The belt should be within 1118-1126 mm (44.0-44.3 in.).
2. Measure the outside width of the drive belt. The belt should be at least 34.5 mm (1.36 in.) on a new belt or 32.5 mm (1.28 in.) on a broken in belt.
3. Check the belt for cracking, fraying, etc.

If any of the specifications or conditions are unsatisfactory, replace the drive belt.

■ **NOTE:** Drive belts should be purchased from an authorized Yamaha Snowmobile dealer, as Yamaha drive belts are made to exact specifications and of quality material. Belts made by other manufacturers may not be of the same specifications or quality and, therefore, usage could result in poor performance and premature belt failure.

■ **NOTE:** Before starting the snowmobile in extremely cold temperatures, the drive belt should be removed and warmed up to room temperature. Once the drive belt is at room temperature, install the drive belt.

Also, new drive belts have a break-in period of approximately 40 km (25 miles). After installing a new drive belt, drive the snowmobile for 40 km (25 miles) at 3/4 throttle or less. By revving the engine up and down (but not exceeding 97 km/h [60 mph]), the exposed cord on the side of a new belt will be worn down. This allows the drive belt to gain its optimum flexibility and will extend drive belt life.

### CAUTION

**Never run the engine with the drive belt removed. Excessive revving of the engine could result in serious engine damage and drive clutch failure.**

### Removing Drive Belt

■ **NOTE:** Changing a drive belt can be done by the snowmobile owner if qualified to do so. If the owner does not feel qualified, take the snowmobile to an authorized Yamaha Snowmobile dealer for this service. This service is at the discretion and expense of the snowmobile owner.

1. Place the snowmobile on a level surface and engage the brake lever lock.
2. Open the left-side access panel and remove the belt guard assembly.
3. Rotate the driven clutch sliding sheave clockwise (1); then push towards the engine (2) so it will separate from the fixed sheave.
4. Remove the drive belt by pulling it up and over the fixed sheave.

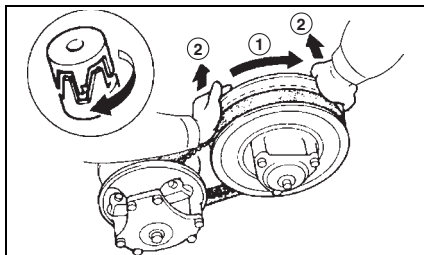

SNO-336

### Installing Drive Belt

■ **NOTE:** Before installing the drive belt, use a suitable cleaning solvent to thoroughly clean the sheaves.

1. Open the left-side access panel.
2. Rotate the driven clutch sliding sheave clockwise (1); then push towards the engine (2) so it will separate from the fixed sheave.
3. Install the drive belt (3) between the sheaves.

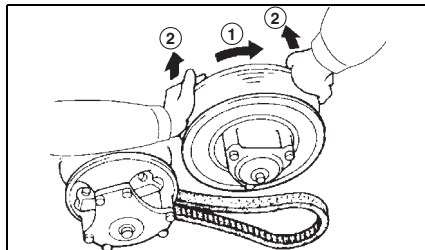

SNO-326

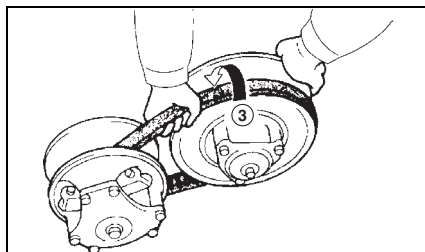

SNO-327

4. Install the left-side access panel.

### ⚠ WARNING

**Never operate the snowmobile without the access panel secured in place.**

## Track Tension

Track tension is directly related to the overall performance of the snowmobile. If the track is too loose, it may slap against the tunnel causing wear or it may “ratchet” on the track drive sprockets. If extremely loose, the idler wheels may climb over the track lugs forcing the track against the tunnel causing the track to “lock.” Yamaha recommends that the track tension be checked daily during the first 500 km (300 miles) of operation and once a week thereafter and adjusted according to need. The track will stretch and take a “set” during break-in. Track deflection must be maintained within the recommended range.

### **⚠ WARNING**

**Track tension must be properly maintained. Personal injury could result if a track is allowed to become excessively loose.**

### Checking Track Tension

### **⚠ WARNING**

**DO NOT attempt to check or adjust track tension with engine running. Turn ignition key to the OFF position. Personal injury could result from contact with a rotating track.**

1. Remove excess ice and snow buildup from the track, track drive sprockets, and the inside of the skid frame.
2. Elevate the snowmobile on a shielded safety stand high enough to use a spring scale.
3. At the mid-point of the track (on the bottom side), hook a spring scale around a track clip; then pull down on the scale to 9 kg (20 lb). Measure the deflection (distance) between the bottom of the wear strip and the inside surface of the track clip. Measurement should be 50 mm (2.0 in.).

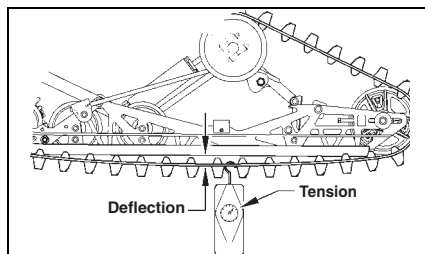

■ **NOTE:** Measurement is from the bottom of the wear strip at the point of the shock pad on the slide rail.

■ **NOTE:** Only tighten track until the track does not ratchet. Too tight of a track will cause the rear suspension to not work properly.

### Adjusting Track Tension

■ **NOTE:** To ensure proper track tension adjustment, perform all adjustments on both sides of the snowmobile.

1. Loosen the idler wheel axle cap screws.

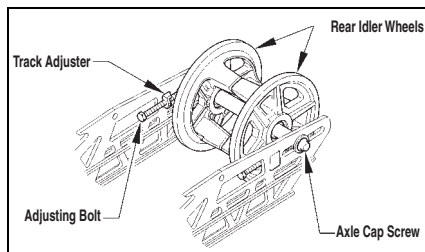

2. If the deflection (distance between the bottom of the wear strip and the inside surface of the track clip) exceeds specifications, tighten the adjusting bolts to take up excessive slack in the track.
3. If the distance between the bottom of the wear strip and the inside surface of the track clip is less than specified, loosen the adjusting bolts to increase the slack in the track.

### **CAUTION**

**Always maintain track tension within recommended specification.**

4. Check track alignment.
5. After proper track tension is obtained, tighten the idler wheel axle cap screws to 4.7 kg-m (34 ft-lb); then tighten the adjusting bolts securely against the axle.

■ **NOTE:** Since track tension and track alignment are interrelated, always check both even if only one adjustment seems necessary.

### ⚠ WARNING

Always make sure the adjusting bolts are snug against the axle and the idler wheel cap screws are tightened to specifications. Failure to do so could cause the track to become extremely loose and, under some operating conditions, allow the idler wheels to climb over the track lugs forcing the track against the tunnel causing the track to “lock.” If a track “locks” during operation, severe personal injury could result.

## Track Alignment

Proper track alignment is obtained when the rear idler wheels are equal distance from the inner track drive lugs. Excessive wear to the idler wheels, drive lugs, and track will occur if the track is improperly aligned. Yamaha recommends that the track alignment be checked once a week or whenever the track tension is adjusted.

### Checking Track Alignment

### ⚠ WARNING

Make sure the ignition key is in the OFF position and the track is not rotating before checking or adjusting track alignment. Personal injury could result if contact is made with a rotating track.

1. Remove excess ice and snow buildup from the track, track drive sprockets, and the inside of the skid frame.

2. Position the tips of the skis against a wall; then using a shielded safety stand, raise the rear of the snowmobile off the floor making sure the track is free to rotate.

### ⚠ WARNING

The tips of the skis must be positioned against a wall or similar object.

### ⚠ WARNING

DO NOT stand behind the snowmobile or near the rotating track. NEVER run the track at high speed when the track is suspended.

3. Start the engine and accelerate slightly. Use only enough throttle to turn the track several revolutions. SHUT ENGINE OFF.

■ **NOTE:** Allow the track to coast to a stop. DO NOT apply the brake because it could produce an inaccurate alignment condition.

4. When the track stops rotating, check the relationship of the rear idler wheels and the inner track drive lugs. If the rear idler wheels are centered between the inner track drive lugs, no adjustment is necessary.

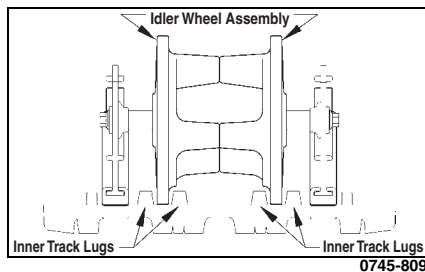

5. If the idler wheels are not centered between the inner track drive lugs, an adjustment is necessary.

## Adjusting Track Alignment

1. On the side of the track which has the inner track drive lugs closer to the rear idler wheel, loosen the idler wheel axle cap screw; then rotate the adjusting bolt clockwise 1 to 1 1/2 turns.

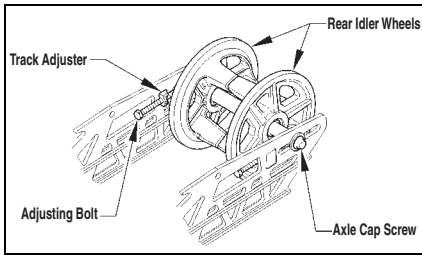

0745-811

2. Check track alignment and continue adjustment until proper alignment is obtained.

■ **NOTE: Make sure correct track tension is maintained after adjusting track alignment.**

3. After proper track adjustments are obtained and the adjusting bolts are snug against the axle housings, tighten the idler wheel axle cap screws to 4.7 kg-m (34 ft-lb).

### ⚠ WARNING

**Always make sure the adjusting bolts are snug against the axle and the idler wheel cap screws are tightened to specifications. Failure to do so could cause the track to become extremely loose and, under some operating conditions, allow the idler wheels to climb over the track lugs forcing the track against the tunnel causing the track to "lock." If a track "locks" during operation, severe personal injury could result.**

4. Field test the track under actual conditions.
5. After the field test, check the alignment of the track. If additional adjustment is necessary, repeat Adjusting Track Alignment procedure.

## Suspension

The suspension should be adjusted for the operational needs and riding preference of the operator.

The front shock springs or shock air pressure determines the amount of ski pressure and the reaction of the front suspension to rough terrain. The amount of ski pressure can also be changed by adjusting the length of the skid frame front arm limiter straps.

The rear arm shock absorber setting or springs influences the load carrying capability of the snowmobile and should be adjusted for the weight and riding preference of the operator.

### ⚠ WARNING

**Read and understand the following information before handling shock absorbers that contain highly pressurized nitrogen gas.**

- Do not tamper with or attempt to open the cylinder assemblies.
- Do not subject the shock absorbers to an open flame or other high heat source. This may cause the unit to explode due to excessive gas pressure.
- Do not deform or damage the cylinders in any way. Cylinder damage will result in poor damping performance.
- Do not dispose of a damaged or worn out shock absorber yourself. Take the shock absorber to a Yamaha dealer for any service.

## Adjusting Front Ski Shock Springs

The front ski shock springs are individually adjustable for the terrain conditions and driving style of the operator. The spring adjuster nut has been set at the factory so the correct amount of threads are exposed between the adjuster nut and the threaded shock body as an initial setting. Additional ski pressure can be obtained by tightening the spring tension; ski pressure can be decreased by relaxing spring tension.

■ **NOTE: Equal adjustments should be maintained on both sides of the snowmobile.**

Front ski shock spring pre-load adjustment is accomplished by loosening the adjuster nut locking collar (B) from the adjuster nut (A) and using the Spring Adjuster Tool from the tool kit, rotating the adjuster nut in whichever direction is desired. Tighten the locking collar against the adjuster nut.



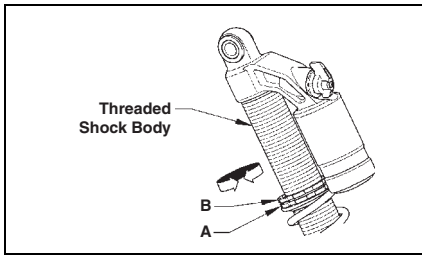

0748-941

To adjust the damping, use the adjustment lever located above the EVOL chamber on the shock. There are three settings that may be chosen 1, 2, or 3.

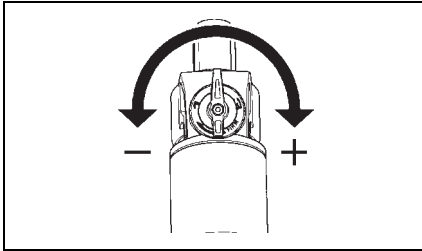

0745-159

### Adjusting Fox Air Shocks

■ **NOTE:** It is recommended to monitor the air pressure in the air shocks once every month.

■ **NOTE:** Adjusting air shocks may be done by the snowmobile owner if qualified to do so. If the owner does not feel qualified, take the snowmobile to an authorized Yamaha Snowmobile dealer for this service. This service is at the discretion and expense of the snowmobile owner.

The air shocks are individually adjustable for the terrain conditions and driving style of the operator. The shocks are preset at the factory (see chart) as an initial setting; however, it is possible to “fine tune” the shocks to match the operator’s weight, riding style, and terrain conditions.

■ **NOTE:** Adding air pressure will increase the air spring force; reducing air pressure will decrease air spring force.

■ **NOTE:** Shock Pressure should be checked/added at room temperature of 65 to 70 degrees. The following settings are recommended but vary on rider preference or style.

Initial Setting Chart			
Model	Front Shock (Ski)	Front Arm Shock	Rear Arm Shock
129" Models	75 psi	N/A	N/A
Long Track Models	100 psi	N/A	130 psi
M-TX, X-TX LE Models	90 psi (Main Chamber) 150 psi (Evol Chamber)	50 psi (Main Chamber) 125 psi (Evol Chamber)	150 psi (Main Chamber) 250 psi (Evol Chamber)
R-TX LE (SR10RL) Models	100 psi (Main Chamber) 200 psi (Evol Chamber)	N/A	N/A

■ **NOTE:** Care should be taken to have equal pressure in the front ski shocks before operating the snowmobile.

To increase or decrease air pressure, use the following procedure.

■ **NOTE:** When adjusting air pressure, all weight must be removed from the suspension, and the shock absorbers must be fully extended.

1. Remove the air valve cap from the shock.
2. Thread the valve of Shock Absorber Air Pump onto the shock air valve approximately six rotations.

■ **NOTE:** As the pump is being attached to the shock, the hose will fill with air. This will result in a lower gauge pressure of 0.14-0.35 kg/cm<sup>2</sup> (2-5 psi).

3. To decrease air pressure in the shock, press the black bleed valve button half way down and hold until desired pressure is attained.

■ **NOTE:** Pressing the button fully down and releasing it will allow only a small amount of air to escape (micro-adjust).

4. To increase air pressure in the shock, pump until desired pressure is attained.
5. Remove the pump valve from the shock air valve.

■ **NOTE:** As the pump valve is being removed from the shock, the sound of air loss is from the pump hose, not from the shock.

6. Install the air valve cap onto the shock.

### Adjusting Skid Frame Front Arm Spring

The skid frame front arm shock spring tension and the limiter straps are adjustable. However, Yamaha recommends that the shock spring be maintained at the factory preset of 3.2-6.4 mm (1/8-1/4 in.) preload. Tightening the skid frame front arm shock spring may cause improper balance and may ruin the handling features of the snowmobile.

The length adjustment of the front arm limiter straps determines the weight distribution between the front of the skid frame and the skis. Tightening the limiter strap (shortening the strap) will pull up on the front of the skid frame and will increase ski pressure. Loosening the limiter strap (lengthening the strap) lowers the front of the skid frame and decreases ski pressure.

When customizing the amount of ski pressure, be sure to adjust both straps equally and do not over-adjust the limiter straps to adversely affect steering and operator control of the snowmobile. Some experimentation may be required until the proper adjustment for the operator's individual style is obtained.

■ **NOTE:** If the limiter straps are adjusted, it is highly recommended that at least a minimum of 3.2 mm (1/8 in.) preload on the shock spring be maintained.

**⚠ WARNING**

**Do not adjust the front arm limiter straps to a point at which steering and operator control of the snowmobile are adversely affected.**

### Adjusting Skid Frame Rear Shock (Limited Models)

To adjust the damping, use the adjustment lever located above the EVOL chamber on the shock. There are three settings that may be chosen: 1, 2, or 3.



SNO-550

### Adjusting Rear Spring Pre-Load

Proper adjustment of rear spring pre-load is necessary to get the most desirable ride. The chart is designed to help in setting up rear spring pre-load; however, riding style is the single greatest factor in determining rear spring requirements.

Rider Weight (lb)	Cam Position
Up to 80 kg (180 lb)	1
80 kg (180 lb) - 110 kg (240 lb)	2
Over 110 kg (240 lb)	3

■ **NOTE:** These cam position settings are suggestions only. Personal riding style will greatly influence cam position settings. Spend time to determine setting preferences.

Rear spring pre-load adjustment is accomplished by rotating the adjusting cams. Position 3 provides the stiffest ride, and position 1 is for the light driver or slowspeed trail riding. Position 2 is for the average operator under normal conditions. Always rotate the cam from the lighter position to the heavier position.

### CAUTION

**Never force the adjustment cams from the low position to the high position. Cam damage may occur.**

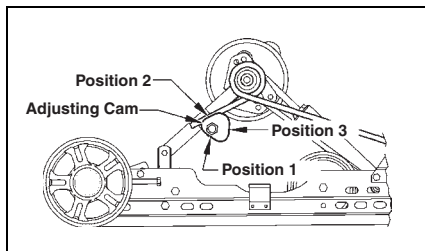

741-450A

To rotate an adjusting cam, use the spark plug wrench from the tool kit. Rotate the wrench until the cam is in the desired position. To stiffen the ride, rotate the cam so as to raise the spring end. Make the appropriate adjustment on the other cam.

## Lights

For the correct headlight bulb and/or taillight/brakelight LED, see the appropriate specifications sheet.

### Removing and Installing Taillight/Brakelight

These models are equipped with an LED taillight/brakelight. If the LED fails, it must be replaced.

1. Disconnect the taillight harness connector.
2. Remove the two machine screws securing the taillight to the bracket.

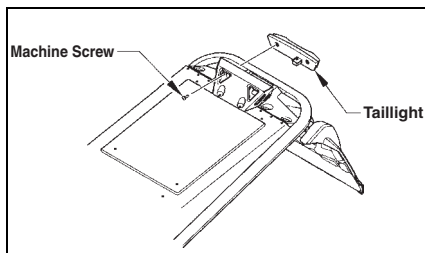

SNO-511

3. Connect the taillight harness connector; then secure the taillight to the bracket with the two screws.

### Removing/Installing Headlight Bulb

■ **NOTE:** The bulb portion of headlight is fragile. HANDLE WITH CARE. When replacing the headlight bulb, the bulb assembly must first be removed from the housing. Do not touch the glass portion of the bulb. If the glass is touched, it must be cleaned with a dry cloth before installing.

1. Disconnect the headlight harness connector from the bulb; then remove the rubber grommet from the headlight housing.
2. Rotate the bulb retainer counter-clockwise until it unlocks from the housing; then remove the bulb.

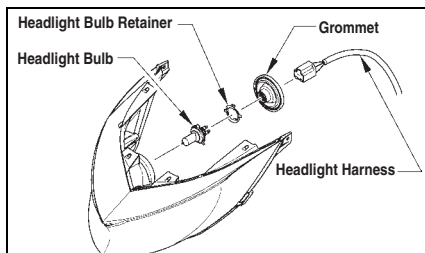

0747-832

3. Install the bulb and retainer; then rotate the retainer clockwise until it properly locks in place.
4. Install the rubber grommet; then connect the headlight harness connector to the bulb.

5. Check headlight aim.

### ⚠ WARNING

**Do not operate the snowmobile unless headlight beam is adjusted properly. An incorrectly adjusted beam will not provide the operator the optimum amount of light.**

### Adjusting Headlight Aim

The headlight can be adjusted for vertical aim of the HIGH/LOW beam. The geometric center of HIGH beam zone is to be used for vertical aiming.

1. Position the snowmobile on a level floor so the headlight is approximately 8 m (25 ft) from an aiming surface (wall or similar surface).

**NOTE: There should be an “average” operating load on the snowmobile when adjusting headlight aim.**

2. Measure the distance from the floor to midpoint of the headlight.
3. Using the measurement obtained in step 2, make a horizontal mark on the aiming surface.
4. Make a vertical mark which intersects the horizontal mark on the aiming surface directly in front of the headlight.
5. Engage the brake lever lock and start the engine. Move the headlight dimmer switch to the HIGH beam position. **DO NOT USE LOW BEAM.**
6. Observe the headlight beam aim. Proper aim is when the most intense beam is centered on the vertical mark 50 mm (2 in.) below the horizontal mark on the aiming surface.

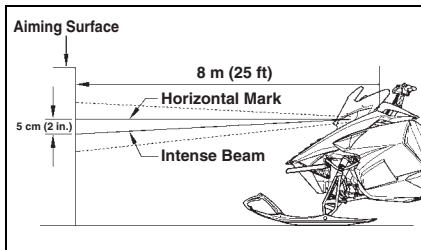

0747-834

7. Adjust the headlight using the adjusting screw on the backside of the headlight using a 4 mm swivel socket and long extension until correct aim is obtained. Shut the engine off; then disengage the brake lever lock.

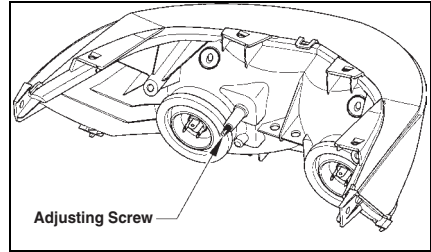

0746-807

### Ski Wear Bars

The ski wear bar is a replaceable bar attached to the underside of the ski. The purpose of the wear bar is to assist in turning the snowmobile, to minimize ski wear, and to maintain good steering control. If the snowmobile is operated primarily in deep snow, ski wear bar wear will be minimal; however, if the snowmobile is operated on terrain where the snow cover is minimal, the ski wear bar will wear faster. To maintain positive steering characteristics, Yamaha recommends that the ski wear bars be checked before each use and replaced if worn beyond 1/2 of the original diameter. Ski wear bars are available from an authorized Yamaha Snowmobile dealer.

### ⚠ WARNING

**Operating the snowmobile with excessively worn ski wear bars may result in a loss of steering control.**

### Removing (Single)

1. Using Front End Lift, elevate the front of the snowmobile.
2. Remove the lock nuts securing the wear bar to the ski.

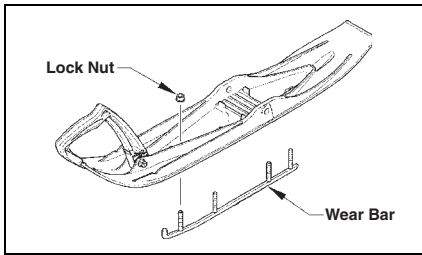

0748-904

3. Remove the wear bar from the ski.

### Installing (Single)

1. Move the wear bar into position on the bottom of the ski.
2. Align the wear bar studs with the holes in the ski; then install the lock nuts. Tighten to 2.0 kg-m (15 ft-lb).

### Removing (Dual)

1. Using Front End Lift, elevate the front of the snowmobile.
2. Remove the lock nuts, washers, and spacers securing the wear bars to the ski.
3. Remove the wear bars from the ski.

■ **NOTE:** When the wear bars are removed, measure the thickness of both wear bars to see if they are within the wear limit of 6.0 mm (0.24 in. (A and B)). Replace as necessary.

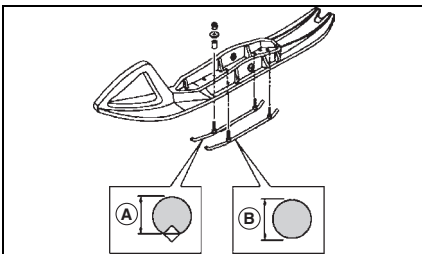

SNO-441A

■ **NOTE:** Measure the thickness of the ski where the front and rear of the wear bar contacts the ski to see if it is within the wear limit of 13 mm (0.51 in.) (A) and 8 mm (0.31 in.) (B). Replace as necessary.

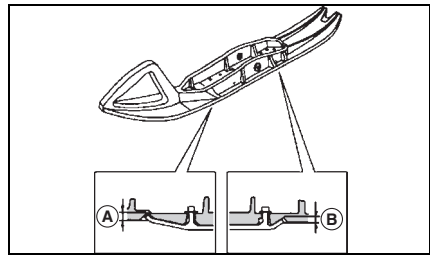

SNO-442A

### Installing (Dual)

1. Position the wear bar with the carbide (A) on the inside of ski and loosely secure using the existing spacer, washer, and nut; then position the wear bar without the carbide (B) on the outside of the ski and loosely secure using the existing spacer, washer, and nut.

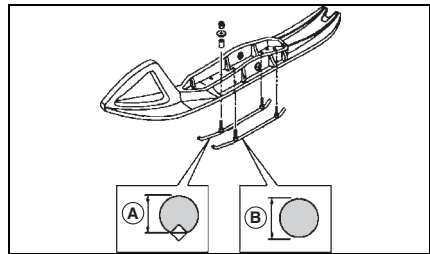

SNO-441A

2. Tighten the nuts evenly to 2.0 kg-m (15 ft-lb).

### Adjusting Ski Stance

■ **NOTE:** Local laws and/or regulations as to maximum width of the ski stance on these snowmobiles may be applicable. Always comply with the maximum width laws and/or regulations when adjusting ski stance.

■ **NOTE:** Ski stance can be increased/decreased by 25 mm (1.0 in.).

### Single Wear Bar

1. Place the front of the snowmobile on a support stand.

- Remove the cotter pin; then remove the slotted nut and cap screw securing the ski assembly to the spindle. Remove the ski. Account for the ski damper, inserts, spacers and washers.

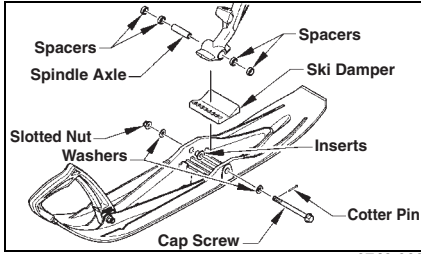

- To increase ski stance, place ski stance spacer to the outside of the spindle and adjust the damper.
- To decrease ski stance, place ski stance spacer to the inside of the spindle and adjust the damper.
- Apply an all-temperature grease to the non-threaded portion of the cap screw; then slide the cap screw through the ski accounting for the rubber damper, inserts, and washers.

■ **NOTE: Install the cap screw so the slotted nut will be located to the inside of the ski.**

- Apply Yamabond Red Threadlocker to the threads of the cap screw; then tighten the nut to 6.2 kg-m (45 ft-lb).
- Place the cotter pin into the ski cap screw and spread the pin.
- Repeat procedure for the other ski.

## Dual Wear Bar

- Place the front of the snowmobile on a support stand.
- Remove the cotter pin; then remove the slotted nut and cap screw securing the ski assembly to the spindle. Remove the ski. Account for the rubber damper, inserts, and washers.
- To increase ski stance, place ski stance spacer to the outside of the spindle and adjust the damper.

- To decrease ski stance, place ski stance spacer to the inside of the spindle and adjust the damper.

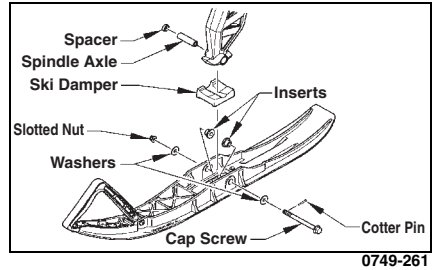
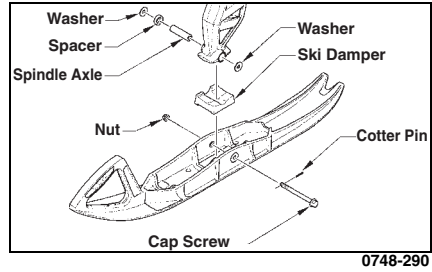

- Apply an all-temperature grease to the non-threaded portion of the cap screw; then slide the cap screw through the ski accounting for the rubber damper, inserts, and washers.

■ **NOTE: Install the cap screw so the slotted nut will be located to the inside of the ski.**

- Apply Yamabond Red Threadlocker to the threads of the cap screw; then tighten the nut to 6.2 kg-m (45 ft-lb).
- Place the cotter pin into the ski cap screw and spread the pin.
- Repeat procedure for the other ski.

## Rail Wear Strips

Yamaha recommends that the wear strips be checked weekly and replaced as necessary. Measure the wear strips at 254 mm (10 in.) intervals. Wear strips must be 10.7 mm (0.42 in.) thick or thicker.

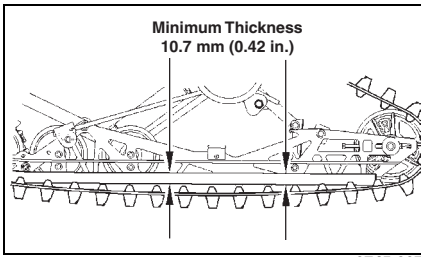

0745-807

If wear strip measurements are less than specified, replacement of both wear strips is necessary to prevent premature track clip wear and possible track damage. Take the snowmobile to an authorized Yamaha Snowmobile dealer for this service. This service is at the discretion and expense of the snowmobile owner.

Each time a new set of wear strips are installed, they should be tempered. Temper the wear strips by driving the snowmobile for approximately a mile on a hard pack trail; then immediately drive into deep snow and allow the wear strips to cool. Repeat the procedure (warming up the wear strips; then cooling them down) two or three times.

■ **NOTE: The rail wear strips will wear rapidly if the snowmobile is operated on terrain on which the snow cover is minimal. Loose snow is required to cool and lubricate the wear strips and prevent accelerated wear.**

■ **NOTE: Two Wheel Kit and Four Wheel Kit are available to reduce wear strip wear.**

■ **NOTE: If operating on ice or hard-packed snow conditions, it is recommended that Ice Scratchers be installed to reduce wear strip wear and engine overheating.**

## Performance Tips

Operating a high performance snowmobile requires a special attention that is not required by a low performance snowmobile. Often, a minor adjustment will result in a large increase in performance. This section is intended to highlight minor conditions that adversely affect performance and the adjustments needed to correct them. Be sure, however, to thoroughly read and understand this entire manual especially the section on spark plugs, track tension and alignment, and suspension.

### DRIVE BELT POSITION

Drive belt length, condition, and position are all important for peak performance. To check and adjust drive belt, remove the belt guard; then use the following procedure.

■ **NOTE: Removing/adding shim washers may be done by the snowmobile owner if qualified to do so. If the owner does not feel qualified, take the snowmobile to an authorized Yamaha Snowmobile dealer for this service. This service is at the discretion and expense of the snowmobile owner.**

1. Turn the engine off; then open the left access panel.
2. Make sure the drive belt is positioned from 1.5 mm (0.06 in.) above the edge of the driven clutch sheaves to 0.5 mm (0.02 in.) below the edge.

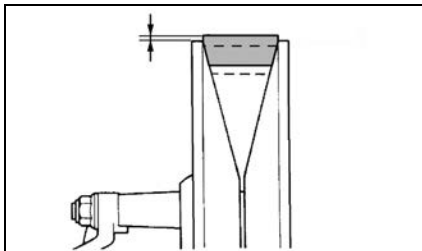

SNO-337

### ⚠ WARNING

**If the belt is not positioned correctly, the clutch engagement speed will be changed. The snowmobile may move unexpectedly when the engine is started.**

3. Adjust the position by removing or adding a spacer on each adjusting bolt.

### CAUTION

**As the belt wears, adjustment may be necessary. To ensure proper clutch performance, the belt position should be adjusted by adding a spacer (2) on each adjusting bolt (1) whenever the belt position reaches 1.5 mm (0.05 in.) below the edge of the sheaves.**

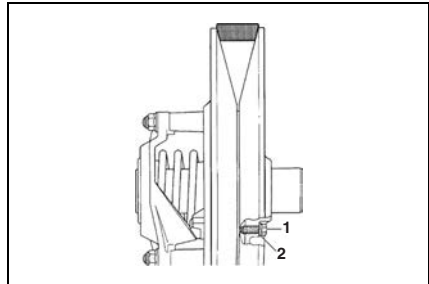

SNO-338

Belt Position	Adjustment
More than 1.5 mm (0.06 in.) above the edge	Remove a spacer
1.5 mm (0.06 in.) above the edge to 0.5 mm (0.02 in.) below the edge	No adjustment necessary
More than 0.5 mm (0.02 in.) below the edge	Add a spacer

Spacer Part Numbers:

90201-061H1: 0.5 mm (0.02 in.)

90201-06037: 1.0 mm (0.04 in.)

4. Close the access panel.

### DRIVE CLUTCH AND DRIVEN CLUTCH

Keeping the drive clutch and driven clutch clean should be the primary consideration of the operator. The drive clutch and driven clutch can be cleaned of any drive belt accumulation using compressed air. The sheaves can be cleaned using a clean cloth and parts-cleaning solvent.



## DRIVE CLUTCH/DRIVEN CLUTCH OFFSET

If premature drive belt wear is experienced or if the drive belt turns over, offset must be checked. Also, offset must be checked whenever either the drive clutch or driven clutch is serviced.

### Checking Offset

1. Remove the left-side access panel; then move the console up and out of the way.
2. Remove the drive belt.

■ **NOTE:** Use a straightedge that is approximately 470 mm (18.5 in.) long, 20 mm (0.79 in.) wide, and 4 mm (0.16 in.) thick.

3. Place the straightedge along the back side of the drive clutch; then measure the offset (a) between the driven clutch and the straightedge. Sheave offset must be within 13.0-16.0 mm (0.51-0.63 in.). If adjustment is needed, proceed to step 4.

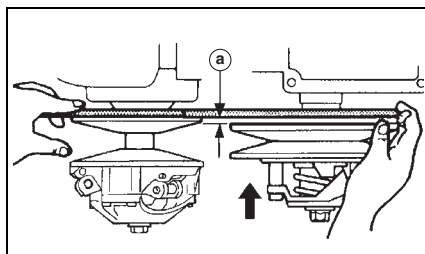

SNO-324

■ **NOTE:** The straightedge must extend beyond the front edge of the drive clutch.

4. If offset adjustment needs to be made, remove the driven clutch and add shims (p/n 8JP-RA449-00: 2 mm, 8JP-RA448-00: 1 mm) to increase the offset or remove shims to decrease the offset.
5. Once the correct offset is reached, install driven clutch and tighten cap screw to 6.4 kg-m (46 ft-lb).

■ **NOTE:** When adjusting the driven clutch, the clutch free play (clearance) should be adjusted.

6. Using a feeler gauge, measure the clutch free play (clearance). Free play (a) should be within 1.0-2.0 mm (0.04-0.08 in.). If adjustment needs to be made proceed to step 7.

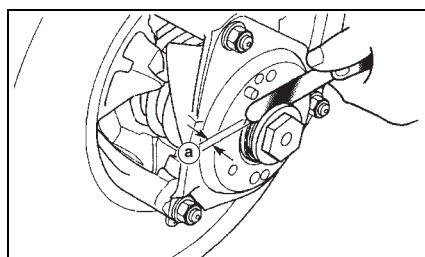

SNO-325

7. Remove the driven clutch cap screw and washer; then add shims (p/n 8JP-RA447-00: 2 mm, 8JP-RA446-00: 1 mm, 8JP-RA433-00: 0.5 mm).
8. Install the driven clutch cap screw and washer. Tighten to 6.4 kg-m (46 ft-lb).

## GASOLINE

For optimum performance, use RON 95 octane (minimum) gasoline.

## Preparation for Storage

Prior to storing the snowmobile, it must be properly serviced to prevent corrosion and component deterioration. An authorized Yamaha Snowmobile dealer should perform this service; however, the owner/operator can perform this service if desired. This service is at the discretion and expense of the snowmobile owner. To prepare the snowmobile for storage, Yamaha recommends the following procedure:

1. Clean the seat cushion with a damp cloth and a Vinyl Protectant.
2. Clean the snowmobile thoroughly by hosing dirt, oil, grass, and other foreign matter from the skid frame, tunnel, hood, and belly pan. Allow the snowmobile to dry thoroughly. DO NOT get water into any part of the engine.
3. Change the engine oil.
4. Plug the exhaust system outlet with a clean cloth.
5. Fill the gas tank to its rated capacity; then add Yamaha Fuel Stabilizer to the gas tank following directions on the container for the stabilizer/gasoline ratio. Tighten the gas tank cap securely.
6. With the snowmobile level, check the lubricant level in the chain case. If low, add chain lube through the fill plug hole.
7. Remove the drive belt from the drive clutch/driven clutch. Lay the belt on a flat surface or slide it into a cardboard sleeve to prevent warping or distortion during storage.
8. Clean and inspect the drive clutch and driven clutch.
9. Apply light oil to the upper steering post bushing and shafts of the shock absorbers.
10. Lubricate the rear suspension with all-temperature grease.

11. Tighten all nuts, bolts, and cap screws making sure all nuts, bolts, and cap screws are tightened securely. Make sure all rivets holding the components together are tight. Replace all loose rivets.
12. Clean and polish the hood, console, and chassis. DO NOT USE SOLVENTS. THE PROPELLANT WILL DAMAGE THE FINISH.

■ **NOTE: Disconnect the battery cables making sure to disconnect the negative cable first; then clean the battery posts and cables. Charge the battery.**

### CAUTION

**Sealed batteries require charging if left for extended non-start periods. Yamaha recommends trickle charging once a month. Follow the manufacturer's instructions and cautions.**

13. If possible, store the snowmobile indoors. Raise the track off the floor by blocking up the back end making sure the snowmobile is secure. Loosen the track adjusting bolts to reduce track tension. Cover the snowmobile with a machine cover or a heavy tarpaulin to protect it from dirt and dust.
14. If the snowmobile must be stored outdoors, position the snowmobile out of direct sunlight; then block the entire snowmobile off the ground making sure the snowmobile is secure. Loosen the track adjusting bolts to reduce track tension. Cover with a machine cover or a heavy tarpaulin to protect it from dirt, dust, and rain.

### CAUTION

**Avoid storing in direct sunlight and using a plastic cover as moisture may collect on the snowmobile causing corrosion.**

# Preparation after Storage

Taking the snowmobile out of storage and correctly preparing it for another season will assure many miles and hours of trouble-free snowmobiling. Yamaha recommends the following procedure:

1. Clean the snowmobile thoroughly. Polish the exterior of the snowmobile.
2. Clean the engine. Remove the cloth from the exhaust system. Check exhaust system and air-intake silencer for obstructions.
3. Inspect all control wires and cables for signs of wear or fraying. Replace if necessary. Use cable ties or tape to route wires and cables away from hot or rotating parts.
4. Inspect the drive belt for cracks and tears. Check belt specifications. Replace if damaged or worn. Install the drive belt.

■ **NOTE: If the old belt is worn but in reasonable condition, retain it with the snowmobile as a spare in case of emergency.**

5. Tighten all nuts, bolts, and cap screws making sure all nuts, bolts, and cap screws are tightened securely.
6. If not done during preparation for storage, lubricate the rear suspension with all-temperature grease.
7. Check the coolant level and all coolant hoses and connections for deterioration or cracks. Add properly mixed coolant as necessary.
8. Charge the battery until fully charged; then connect the battery cables making sure to connect the positive cable first. Test the electric start system.
9. Inspect the entire brake system, all controls, headlight, taillight, brakelight, ski wear bars, and headlight aim; adjust or replace as necessary.
10. Adjust the track to the proper tension and alignment.

## Noise level and vibration level

Noise level (77/311/EEC):

92 dB(A)@4375 r/min

Uncertainty of measurement:

3.0 dB(A)

A-weighted sound power level:

103 dB(A)@4375 r/min

Uncertainty of measurement:

3.0 dB(A)

Vibration on seat (EN1032, ISO 5008):

Not exceed 0.5 m/s<sup>2</sup>

Uncertainty of measurement:

0.2 m/s<sup>2</sup>

Vibration on handlebar (EN1032, ISO 5008):













Not exceed 2.5 m/s<sup>2</sup>

Uncertainty of measurement:

0.2 m/s<sup>2</sup>

The figures quoted are emission levels and are not necessarily safe working levels. Whilst there is a correlation between the emission and exposure levels, this cannot be used reliably to determine whether or not further precautions are required. Factors that influence the actual level of exposure of work-force include the characteristics of the work room, the other sources of noise, etc. i.e. the number of machines and other adjacent processes, and the length of time for which an operator is exposed to the noise. Also the permissible exposure level can vary from country. This information, however, will enable the user of the machine to make a better evaluation of the hazard and risk.

# Snowmobile Safety Rules

<p><b>6</b> Beware of trees and other hazards. Do not drink and ride. Always wear your seat belt. Always use proper tie-down technique. Always follow the manufacturer's instructions.</p> 	<p><b>7</b> Always use a seat belt for towing. Always use proper tie-down technique. Always follow the manufacturer's instructions.</p> 	<p><b>8</b> Observe proper rider capacity. Do not drink and ride. Always wear your seat belt. Always use proper tie-down technique. Always follow the manufacturer's instructions.</p> 	<p><b>9</b> Always wear your seat belt. Always use proper tie-down technique. Always follow the manufacturer's instructions.</p> 
<p><b>5</b> Don't ride after midnight. Do not drink and ride. Always wear your seat belt. Always use proper tie-down technique. Always follow the manufacturer's instructions.</p> 	<p><b>7</b> Always use a seat belt for towing. Always use proper tie-down technique. Always follow the manufacturer's instructions.</p> 	<p><b>8</b> Observe proper rider capacity. Do not drink and ride. Always wear your seat belt. Always use proper tie-down technique. Always follow the manufacturer's instructions.</p> 	<p><b>10</b> Do not drink and ride. Always wear your seat belt. Always use proper tie-down technique. Always follow the manufacturer's instructions.</p> 
<p><b>11</b> Read and understand your Operator's Manual. Use and comprehend your Operator's Manual. Always follow the manufacturer's instructions.</p> 	<p><b>12</b> Observe local laws and regulations and use proper tie-down technique. Always follow the manufacturer's instructions.</p> 	<p><b>10</b> Do not drink and ride. Always wear your seat belt. Always use proper tie-down technique. Always follow the manufacturer's instructions.</p> 	<p><b>12</b> Observe local laws and regulations and use proper tie-down technique. Always follow the manufacturer's instructions.</p> 

## SNOWMOBILE SAFETY RULES

Always follow manufacturer's and instructor's instructions. Do not drink and ride. Always wear your seat belt. Always use proper tie-down technique. Always follow the manufacturer's instructions.

## RÈGLEMENTS DE SÉCURITÉ EN MOTONEIGE

Yamaha s'engage à encourager l'utilisation sécuritaire de toutes les motoneiges. Respectez toujours ces règlements qui vous permettront de profiter de sport avec plaisir. Veuillez vous référer au manuel de l'opérateur pour les instructions complètes de sécurité.

## SAKERHETSREGLER VID SNÖSKOTERKÖRNING

Yamaha s'engager à encourager l'utilisation sécuritaire de toutes les motoneiges. Respectez toujours ces règlements qui vous permettront de profiter de sport avec plaisir. Veuillez vous référer au manuel de l'opérateur pour les instructions complètes de sécurité.

## MOOTTORIKELKAN TURVASÄÄNNÖT





Yamaha s'engage à encourager l'utilisation sécuritaire de toutes les motoneiges. Respectez toujours ces règlements qui vous permettront de profiter de sport avec plaisir. Veuillez vous référer au manuel de l'opérateur pour les instructions complètes de sécurité.

## SIKIKERHETSREGLER FOR BRUK AV SNØSKOOTER

Yamaha s'engager à encourager l'utilisation sécuritaire de toutes les motoneiges. Respectez toujours ces règlements qui vous permettront de profiter de sport avec plaisir. Veuillez vous référer au manuel de l'opérateur pour les instructions complètes de sécurité.

## NORME DI SICUREZZA PER LE MOTOSLITTE

Yamaha s'engage à encourager l'utilisation sécuritaire de toutes les motoneiges. Respectez toujours ces règlements qui vous permettront de profiter de sport avec plaisir. Veuillez vous référer au manuel de l'opérateur pour les instructions complètes de sécurité.

<p><b>1</b> Don't drink and ride. Do not drink and ride. Always wear your seat belt. Always use proper tie-down technique. Always follow the manufacturer's instructions.</p> 	<p><b>2</b> Always wear a helmet. Always use proper tie-down technique. Always follow the manufacturer's instructions.</p> 
<p><b>3</b> Watch out for thin ice/open water. Do not drink and ride. Always wear your seat belt. Always use proper tie-down technique. Always follow the manufacturer's instructions.</p> 	<p><b>4</b> Use caution when crossing road/train tracks. Do not drink and ride. Always wear your seat belt. Always use proper tie-down technique. Always follow the manufacturer's instructions.</p> 





PRINTED IN U.S.A.