



⚠ Read this manual carefully before operating this vehicle.

OWNER'S MANUAL

NIKEN

GT

MXT850D

B5B-28199-E0 ●

 **Read this manual carefully before operating this vehicle. This manual should stay with this vehicle if it is sold.**

Declaration of Conformity:

Hereby, YAMAHA MOTOR ELECTRONICS Co., Ltd declares that the radio equipment type, IMMOBILIZER, BD5-01 is in compliance with Directive 2014/53/EU.

The full text of the EU declaration of conformity is available at the following internet address:

https://global.yamaha-motor.com/eu_doc/

Frequency band: 134.2 kHz

The maximum radio frequency power: 49.0 [dB μ V/m]

Manufacturer:

YAMAHA MOTOR ELECTRONICS Co., Ltd

1450-6 Mori, Mori-machi, Shuchi-Gun, Shizuoka, 437-0292 Japan

Importer:

YAMAHA MOTOR EUROPE N.V.

Koolhovenlaan 101, 1119 NC Schiphol-Rijk, 1117 ZN, Schiphol, the Netherlands

Welcome to the Yamaha world of motorcycling!

As the owner of the MXT850D, you are benefiting from Yamaha's vast experience and newest technology regarding the design and manufacture of high-quality products, which have earned Yamaha a reputation for dependability.

Please take the time to read this manual thoroughly, so as to enjoy all advantages of your MXT850D. The Owner's Manual does not only instruct you in how to operate, inspect and maintain your motorcycle, but also in how to safeguard yourself and others from trouble and injury.

In addition, the many tips given in this manual will help keep your motorcycle in the best possible condition. If you have any further questions, do not hesitate to contact your Yamaha dealer.

The Yamaha team wishes you many safe and pleasant rides. So, remember to put safety first!

Yamaha continually seeks advancements in product design and quality. Therefore, while this manual contains the most current product information available at the time of printing, there may be minor discrepancies between your motorcycle and this manual. If there is any question concerning this manual, please consult a Yamaha dealer.





Please read this manual carefully and completely before operating this motorcycle.

Important manual information

EAU10134

Particularly important information is distinguished in this manual by the following notations:

	This is the safety alert symbol. It is used to alert you to potential personal injury hazards. Obey all safety messages that follow this symbol to avoid possible injury or death.
 WARNING	A WARNING indicates a hazardous situation which, if not avoided, could result in death or serious injury.
NOTICE	A NOTICE indicates special precautions that must be taken to avoid damage to the vehicle or other property.
TIP	A TIP provides key information to make procedures easier or clearer.

*Product and specifications are subject to change without notice.

EAU10201

**MXT850D
OWNER'S MANUAL**
©2019 by Yamaha Motor Co., Ltd.
1st edition, August 2018
All rights reserved.
Any reprinting or unauthorized use
without the written permission of
Yamaha Motor Co., Ltd.
is expressly prohibited.
Printed in Japan.

Table of contents

Safety information	1-1	Adjusting the front fork	3-31	Engine oil	6-11
Description	2-1	Adjusting the shock absorber assembly.....	3-32	Why Yamalube.....	6-13
Left view	2-1	Auxiliary DC jacks	3-34	Coolant	6-14
Right view.....	2-2	Sidestand	3-35	Air filter element.....	6-15
Controls and instruments	2-3	Ignition circuit cut-off system	3-35	Checking the engine idling speed	6-15
Instrument and control functions ...	3-1	For your safety – pre-operation checks	4-1	Checking the throttle grip free play.....	6-16
Immobilizer system.....	3-1	Operation and important riding points	5-1	Valve clearance.....	6-16
Main switch/steering lock.....	3-2	Starting the engine.....	5-1	Tires	6-16
Handlebar switches.....	3-3	Shifting	5-2	Cast wheels	6-19
Indicator lights and warning lights.....	3-5	Tips for reducing fuel consumption.....	5-4	Adjusting the clutch lever free play.....	6-19
Cruise control system.....	3-8	Engine break-in.....	5-4	Checking the brake lever free play.....	6-20
Multi-function meter unit	3-11	Parking.....	5-5	Brake light switches	6-20
D-mode (drive mode).....	3-19	Periodic maintenance and adjustment	6-1	Checking the front and rear brake pads	6-21
Clutch lever	3-19	Tool kit	6-2	Checking the brake fluid level	6-22
Shift pedal	3-20	Periodic maintenance charts	6-3	Changing the brake fluid	6-23
Quick shift system	3-20	Periodic maintenance chart for the emission control system.....	6-3	Drive chain slack.....	6-23
Brake lever.....	3-21	General maintenance and lubrication chart.....	6-5	Cleaning and lubricating the drive chain.....	6-25
Brake pedal	3-21	Removing and installing the panel	6-9	Checking and lubricating the drive chain.....	6-25
ABS	3-21	Checking the spark plugs	6-10	Checking and lubricating the cables.....	6-25
Traction control system.....	3-22	Canister.....	6-11	Checking and lubricating the throttle grip and cable.....	6-26
Fuel tank cap.....	3-24			Checking and lubricating the brake and shift pedals.....	6-26
Fuel.....	3-25			Checking and lubricating the brake and clutch levers.....	6-27
Fuel tank overflow hose	3-27				
Catalytic converter	3-27				
Seats	3-28				
Helmet holding cable.....	3-29				
Storage compartment	3-30				
Rear view mirrors.....	3-31				

Table of contents

Checking and lubricating the centerstand and sidestand	6-27
Lubricating the swingarm pivots	6-28
Checking the front fork.....	6-28
Checking the steering	6-29
Lubricating the steering bearings	6-29
Checking the wheel bearings	6-30
Battery	6-30
Replacing the fuses.....	6-31
Vehicle lights	6-33
Troubleshooting	6-34
Troubleshooting charts	6-35
Motorcycle care and storage	7-1
Matte color caution	7-1
Care.....	7-1
Storage.....	7-3
Specifications.....	8-1
Consumer information	9-1
Identification numbers.....	9-1
Diagnostic connector	9-2
Vehicle data recording	9-2
Index	10-1

Be a Responsible Owner

As the vehicle's owner, you are responsible for the safe and proper operation of your motorcycle.

This is a leaning multi-wheel motorcycle.

The safe use and operation of this motorcycle is dependent upon the use of proper riding techniques as well as the expertise of the operator. Every operator should know the following requirements before riding this motorcycle.

He or she should:

- Obtain thorough instructions from a competent source on all aspects of motorcycle operation.
- Observe the warnings and maintenance requirements in this Owner's Manual.
- Obtain qualified training in safe and proper riding techniques.
- Obtain professional technical service as indicated in this Owner's Manual and when made necessary by mechanical conditions.

- Never operate a motorcycle without proper training or instruction. Take a training course. Beginners should receive training from a certified instructor. Contact an authorized motorcycle dealer to find out about the training courses nearest you.

Safe Riding

Perform the pre-operation checks each time you use the vehicle to make sure it is in safe operating condition. Failure to inspect or maintain the vehicle properly increases the possibility of an accident or equipment damage. See page 4-1 for a list of pre-operation checks.

- This motorcycle is designed to carry the operator and a passenger.
- The failure of motorists to detect and recognize motorcycles in traffic is the predominating cause of automobile-and-motorcycle accidents. Many accidents have been caused by an automobile driver who did not see the motorcycle. Making yourself conspicuous ap-

pears to be very effective in reducing the chance of this type of accident.

Therefore:

- Wear a brightly colored jacket.
- Use extra caution when you are approaching and passing through intersections, since intersections are the most likely places for motorcycle accidents to occur.
- Ride where other motorists can see you. Avoid riding in another motorist's blind spot.
- Never maintain a motorcycle without proper knowledge. Contact an authorized motorcycle dealer to inform you on basic motorcycle maintenance. Certain maintenance can only be carried out by certified staff.

- Many accidents involve inexperienced operators. In fact, many operators who have been involved in accidents do not even have a current motorcycle license.
 - Make sure that you are qualified and that you only lend your motorcycle to other qualified operators.
 - Know your skills and limits. Staying within your limits may help you to avoid an accident.
 - We recommend that you practice riding your motorcycle where there is no traffic until you have become thoroughly familiar with the motorcycle and all of its controls.
- Many accidents have been caused by error of the motorcycle operator. A typical error made by the operator is veering wide on a turn due to excessive speed or undercornering (insufficient lean angle for the speed).
 - Always obey the speed limit and never travel faster than warranted by road and traffic conditions.
 - Always signal before turning or changing lanes. Make sure that other motorists can see you.
- The posture of the operator and passenger is important for proper control.
 - The operator should keep both hands on the handlebar and both feet on the operator footrests during operation to maintain control of the motorcycle.
 - The passenger should always hold onto the operator, the seat strap or grab bar, if equipped, with both hands and keep both feet on the passenger footrests. Never carry a passenger unless he or she can firmly place both feet on the passenger footrests.
- Never ride under the influence of alcohol or other drugs.
- This motorcycle is designed for on-road use only. It is not suitable for off-road use.

Protective Apparel

The majority of fatalities from motorcycle accidents are the result of head injuries. The use of a safety helmet is the single most critical factor in the prevention or reduction of head injuries.

- Always wear an approved helmet.
- Wear a face shield or goggles. Wind in your unprotected eyes could contribute to an impairment of vision that could delay seeing a hazard.
- The use of a jacket, heavy boots, trousers, gloves, etc., is effective in preventing or reducing abrasions or lacerations.
- Never wear loose-fitting clothes, otherwise they could catch on the control levers, footrests, or wheels and cause injury or an accident.
- Always wear protective clothing that covers your legs, ankles, and feet. The engine and exhaust system become very hot during or after operation and can cause burns.
- A passenger should also observe the above precautions.

Safety information

1

Avoid Carbon Monoxide Poisoning

All engine exhaust contains carbon monoxide, a deadly gas. Breathing carbon monoxide can cause headaches, dizziness, drowsiness, nausea, confusion, and eventually death.

Carbon Monoxide is a colorless, odorless, tasteless gas which may be present even if you do not see or smell any engine exhaust. Deadly levels of carbon monoxide can collect rapidly and you can quickly be overcome and unable to save yourself. Also, deadly levels of carbon monoxide can linger for hours or days in enclosed or poorly ventilated areas. If you experience any symptoms of carbon monoxide poisoning, leave the area immediately, get fresh air, and **SEEK MEDICAL TREATMENT.**

- Do not run engine indoors. Even if you try to ventilate engine exhaust with fans or open windows and doors, carbon monoxide can rapidly reach dangerous levels.
- Do not run engine in poorly ventilated or partially enclosed areas such as barns, garages, or carports.

- Do not run engine outdoors where engine exhaust can be drawn into a building through openings such as windows and doors.

Loading

Adding accessories or cargo to your motorcycle can adversely affect stability and handling if the weight distribution of the motorcycle is changed. To avoid the possibility of an accident, use extreme caution when adding cargo or accessories to your motorcycle. Use extra care when riding a motorcycle that has added cargo or accessories. Here, along with the information about accessories below, are some general guidelines to follow if loading cargo to your motorcycle:

The total weight of the operator, passenger, accessories and cargo must not exceed the maximum load limit.

Operation of an overloaded vehicle could cause an accident.

<p>Maximum load: 191 kg (421 lb)</p>

When loading within this weight limit, keep the following in mind:

- Cargo and accessory weight should be kept as low and close to the motorcycle as possible. Securely pack your heaviest items as close to the center of the vehicle as possible and make sure to distribute the weight as evenly as possible on both sides of the motorcycle to minimize imbalance or instability.
- Shifting weights can create a sudden imbalance. Make sure that accessories and cargo are securely attached to the motorcycle before riding. Check accessory mounts and cargo restraints frequently.
- Properly adjust the suspension for your load (suspension-adjustable models only), and check the condition and pressure of your tires.
- Never attach any large or heavy items to the handlebar, front fork, or front fenders. These items, including such cargo as sleeping bags, duffel bags, or

tents, can create unstable handling or a slow steering response.

- **This vehicle is not designed to pull a trailer or to be attached to a sidecar.**

Genuine Yamaha Accessories

Choosing accessories for your vehicle is an important decision. Genuine Yamaha accessories, which are available only from a Yamaha dealer, have been designed, tested, and approved by Yamaha for use on your vehicle.

Many companies with no connection to Yamaha manufacture parts and accessories or offer other modifications for Yamaha vehicles. Yamaha is not in a position to test the products that these aftermarket companies produce. Therefore, Yamaha can neither endorse nor recommend the use of accessories not sold by Yamaha or modifications not specifically recommended by Yamaha, even if sold and installed by a Yamaha dealer.

Aftermarket Parts, Accessories, and Modifications

While you may find aftermarket products similar in design and quality to genuine Yamaha accessories, recognize that some aftermarket accessories or modifications are not suitable because of potential safety hazards to you or others. Installing aftermarket products or having other modifications performed to your vehicle that change any of the vehicle's design or operation characteristics can put you and others at greater risk of serious injury or death. You are responsible for injuries related to changes in the vehicle.

Keep the following guidelines in mind, as well as those provided on page 1-3 when mounting accessories.

- Never install accessories or carry cargo that would impair the performance of your motorcycle. Carefully inspect the accessory before using it to make sure that it does not in any way reduce ground clearance or cornering clearance, limit suspension travel,

steering travel or control operation, or obscure lights or reflectors.

- Accessories fitted to the handlebar or the front fork area can create instability due to improper weight distribution or aerodynamic changes. If accessories are added to the handlebar or front fork area, they must be as lightweight as possible and should be kept to a minimum.
- Bulky or large accessories may seriously affect the stability of the motorcycle due to aerodynamic effects. Wind may attempt to lift the motorcycle, or the motorcycle may become unstable in cross winds. These accessories may also cause instability when passing or being passed by large vehicles.
- Certain accessories can displace the operator from his or her normal riding position. This improper position limits the freedom of movement of the

Safety information

1

operator and may limit control ability, therefore, such accessories are not recommended.

- Use caution when adding electrical accessories. If electrical accessories exceed the capacity of the motorcycle's electrical system, an electric failure could result, which could cause a dangerous loss of lights or engine power.

Aftermarket Tires and Rims

The tires and rims that came with your motorcycle were designed to match the performance capabilities and to provide the best combination of handling, braking, and comfort. Other tires, rims, sizes, and combinations may not be appropriate. See page 6-16 for tire specifications and for information on servicing and replacing your tires.

Transporting the Motorcycle

Be sure to observe the following instructions before transporting the motorcycle in another vehicle.

- Remove all loose items from the motorcycle.
- Confirm there are no fuel or oil leaks.
- Shift the transmission into gear.
- Secure with suitable straps that are attached to solid parts of the motorcycle, such as the frame or upper front fork triple clamp. Do not attach to turn signals, cowlings and fairings, or any other parts that can break. Choose the location for the straps carefully so the straps will not rub against painted surfaces during transport.
- The suspension should be partially compressed by the tie-down straps so that the motorcycle will not bounce excessively during transport.

Left view

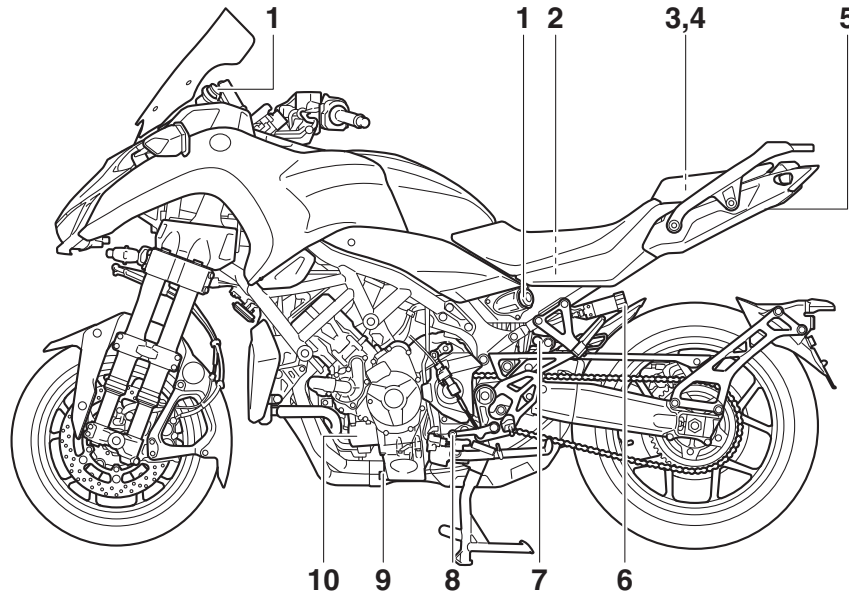

1. Auxiliary DC jack (page 3-34)

2. Battery (page 6-30)

3. Storage compartment (page 3-30)

4. Tool kit (page 6-2)

5. Seat lock (page 3-28)

6. Spring preload adjuster (page 3-32)

7. Rebound damping force adjuster (page 3-32)

8. Shift pedal (page 3-20)

9. Engine oil drain bolt (page 6-11)

10. Engine oil filter cartridge (page 6-11)

Description

EAU10421

Right view

2

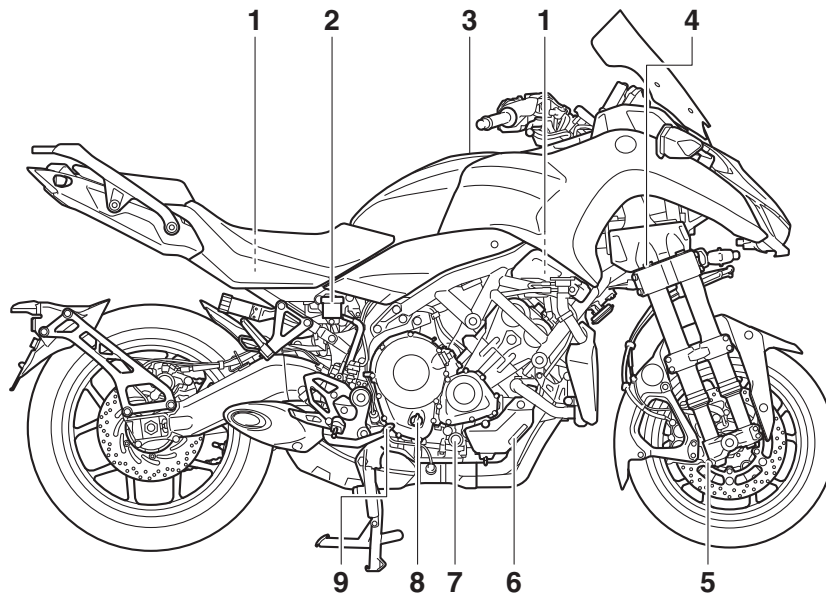

1. Fuses (page 6-31)

2. Rear brake fluid reservoir (page 6-22)

3. Fuel tank cap (page 3-24)

4. Rebound damping force adjuster (page 3-31)

5. Compression damping force adjuster (page 3-31)

6. Coolant reservoir (page 6-14)

7. Engine oil level check window (page 6-11)

8. Engine oil filler cap (page 6-11)

9. Brake pedal (page 3-21)

Controls and instruments

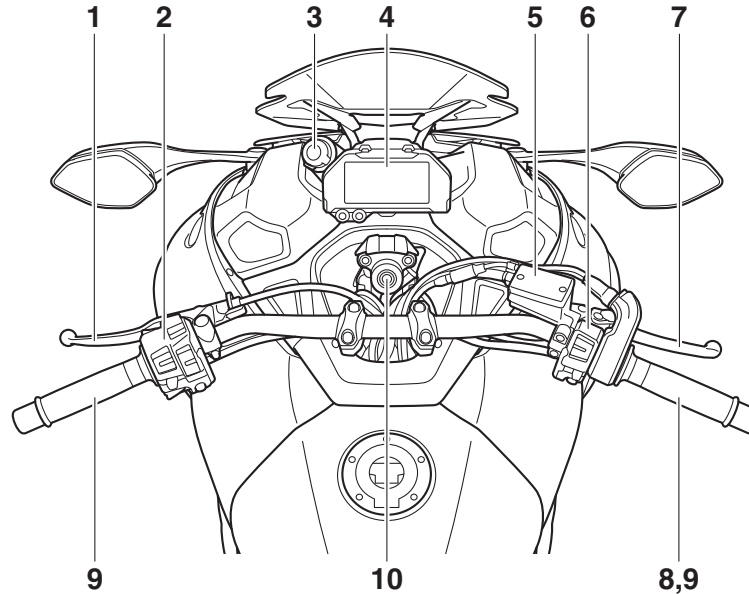

1. Clutch lever (page 3-19)
2. Left handlebar switches (page 3-3)
3. Auxiliary DC jack (page 3-34)
4. Multi-function meter unit (page 3-11)
5. Front brake fluid reservoir (page 6-22)
6. Right handlebar switches (page 3-3)
7. Brake lever (page 3-21)
8. Throttle grip (page 6-16)

9. Grip warmer (page 3-14)
10. Main switch/steering lock (page 3-2)

Instrument and control functions

3

Immobilizer system

EAU10979

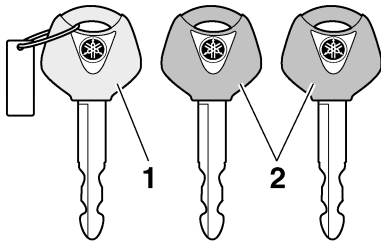

1. Code re-registering key (red bow)
2. Standard keys (black bow)

This vehicle is equipped with an immobilizer system to help prevent theft by re-registering codes in the standard keys. This system consists of the following:

- a code re-registering key
- two standard keys
- a transponder (in each key)
- an immobilizer unit (on the vehicle)
- an ECU (on the vehicle)
- a system indicator light (page 3-7)

About the keys

The key with the red bow is used to register codes in each standard key. Store the code re-registering key in a safe place. When necessary, take the vehicle along with all three keys to a Yamaha dealer to have them re-registered.

Do not use the key with the red bow for driving. It should only be used for re-registering the standard keys. Always use a standard key for driving.

TIP

- Keep the standard keys as well as keys of other immobilizer systems away from the code re-registering key.
- Keep other immobilizer system keys away from the main switch as they may cause signal interference.

ECA11823

NOTICE

DO NOT LOSE THE CODE RE-REGISTERING KEY! CONTACT YOUR DEALER IMMEDIATELY IF IT IS LOST! If the code re-registering key is lost, the existing standard keys

can still be used to start the vehicle. However, registering a new standard key is impossible. If all keys have been lost or damaged, the entire immobilizer system must be replaced. Therefore, handle the keys carefully.

- Do not submerge in water.
- Do not expose to high temperatures.
- Do not place near magnets.
- Do not place near items that transmit electrical signals.
- Do not handle roughly.
- Do not grind or alter.
- Do not disassemble.
- Do not put two keys of any immobilizer system on the same key ring.

Main switch/steering lock

EAU10474

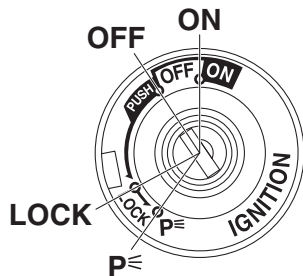

The main switch/steering lock controls the ignition and lighting systems, and is used to lock the steering. The various positions are described below.

TIP

Be sure to use the standard key (black bow) for regular use of the vehicle. To minimize the risk of losing the code re-registering key (red bow), keep it in a safe place and only use it for code re-registering.

ON

All electrical circuits are supplied with power and the vehicle lights are turned on. The engine can be started. The key cannot be removed.

TIP

- The headlight(s) will turn on when the engine is started.
- To prevent battery drain, do not leave the key in the on position without the engine running.

OFF

All electrical systems are off. The key can be removed.

⚠ WARNING

Never turn the key to “OFF” or “LOCK” while the vehicle is moving. Otherwise the electrical systems will be switched off, which may result in loss of control or an accident.

EAU84031

LOCK

The steering is locked and all electrical systems are off. The key can be removed.

To lock the steering

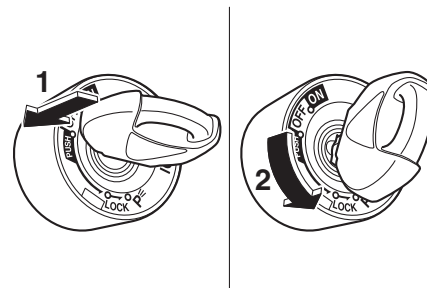

1. Push.
2. Turn.

1. Turn the handlebars all the way to the left.
2. With the key in the “OFF” position, push the key in and turn it to “LOCK”.
3. Remove the key.

EAU1068B

Instrument and control functions

TIP

If the steering will not lock, try turning the handlebars back to the right slightly.

3

To unlock the steering

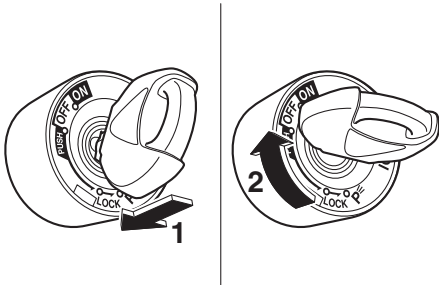

1. Push.
2. Turn.

From the “LOCK” position, push the key in and turn it to “OFF”.

p (Parking)

EAU65680

The hazard lights can be turned on, but all other electrical systems are off. The key can be removed.

The steering must be locked before the key can be turned to “p”.

ECA22330

NOTICE



Using the hazard lights for an extended length of time may cause the battery to discharge.

EAU66055

Handlebar switches

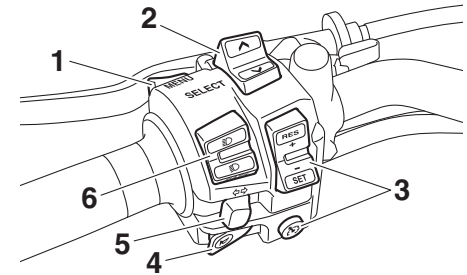
Left



1. “MENU” switch
2. “SELECT” switch
3. Cruise control switches
4. Horn switch “”
5. Turn signal switch “”
6. Dimmer/Pass switch “/PASS”

Right

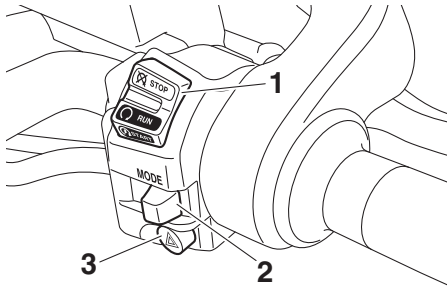

1. Stop/Run/Start switch “/”
2. Drive mode switch “MODE”
3. Hazard switch “”

Dimmer/Pass switch “/”

Set this switch to “” for the high beam and to “” for the low beam. To flash the high beam, press the switch down to “PASS” while the headlights are on low beam.

TIP

When the switch is set to low beam, only the two outer headlights come on. When the switch is set to high beam, the two inner headlights also come on.

Turn signal switch “/”

To signal a right-hand turn, push this switch to “”. To signal a left-hand turn, push this switch to “”. When released, the switch returns to the center position. To cancel the turn signal lights, push the switch in after it has returned to the center position.

Horn switch “”

Press this switch to sound the horn.

Stop/Run/Start switch “/”

To crank the engine with the starter, set this switch to “”, and then push the switch down towards “”. See page 5-1 for starting instructions prior to starting the engine. Set this switch to “” to stop the engine in case of an emergency, such as when the vehicle overturns or when the throttle cable is stuck.

Hazard switch “”

With the key in the “ON” or “P” position, use this switch to turn on the hazard lights (simultaneous flashing of all turn signal lights).

The hazard lights are used in case of an emergency or to warn other drivers when your vehicle is stopped where it might be a traffic hazard.

NOTICE

Do not use the hazard lights for an extended length of time with the engine not running, otherwise the battery may discharge.

Cruise control switches

See page 3-8 for an explanation of the cruise control system.

“MENU” switch

This switch is used to make setting changes within the multi-function meter unit. (See page 3-11.)

Instrument and control functions

“SELECT” switch

EAU84530

This switch is used to make setting changes within the multi-function meter unit. (See page 3-11.)

3

Drive mode switch “MODE”







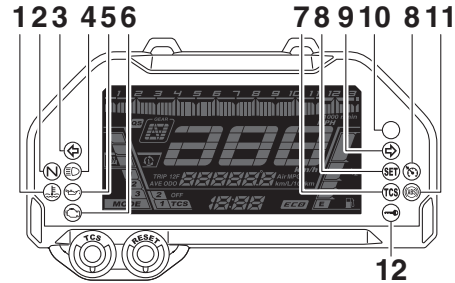

EAU84260

See page 3-19 for an explanation of the drive mode.

Indicator lights and warning lights

EAU4939G



1. Coolant temperature warning light “”
2. Neutral indicator light “**N**”
3. Left turn signal indicator light “”
4. High beam indicator light “”
5. Oil level warning light “”
6. Engine trouble warning light “”
7. Traction control system indicator light “TCS”
8. Cruise control indicator lights “” “SET”
9. Right turn signal indicator light “”
10. Shift indicator light
11. ABS warning light “”
12. Immobilizer system indicator light “”

Turn signal indicator lights “” and “”

EAU11032

Each indicator light will flash when its corresponding turn signal lights are flashing.

Neutral indicator light “**N**”

EAU11061

This indicator light comes on when the transmission is in the neutral position.

High beam indicator light “”

EAU11081

This indicator light comes on when the high beam of the headlight is switched on.

Oil level warning light “”

EAU11259

This warning light comes on when the engine oil level is low. To prevent engine damage, replenish the engine oil as soon as possible.

Even if the oil level is sufficient, the warning light may flicker when riding on a slope or during sudden acceleration or deceleration, but this is not a malfunction. If a problem is detected in the oil level detection circuit, the oil lev-

el warning light will flash repeatedly. If this occurs, have a Yamaha dealer check the vehicle.

TIP _____

When the vehicle is turned on, this light will come on for a few seconds and then go off. If the light does not come on, or if the light remains on after confirming that the oil level is correct (see page 6-11), have a Yamaha dealer check the vehicle.

Cruise control indicator lights “” and “SET”

These indicator lights come on when the cruise control system is activated. (See page 3-8.)

TIP _____

When the vehicle is turned on, these lights should come on for a few seconds and then go off. If the lights do not come on, have a Yamaha dealer check the vehicle.

Coolant temperature warning light “”

This warning light comes on when the engine is overheating. If this occurs, stop the engine immediately and allow the engine to cool. (See page 6-36.)

For vehicles with a radiator fan, the radiator fan(s) automatically switch on or off according to the coolant temperature.

TIP _____

When the vehicle is turned on, the light will come on for a few seconds, and then go off. If the light does not come on, or if the light remains on, have a Yamaha dealer check the vehicle.

NOTICE _____

Do not continue to operate the engine if it is overheating.

Engine trouble warning light “”

This warning light comes on if a problem is detected in the engine. If this occurs, have a Yamaha dealer check the on-board diagnostic system.

The electrical circuit of the warning light can be checked by turning the vehicle power on. The warning light should come on for a few seconds, and then go off.

If the warning light does not come on at all, or if the warning light remains on, have a Yamaha dealer check the vehicle.

ABS warning light “”

This warning light comes on when the vehicle is first turned on, and goes off after starting riding. If the warning light comes on while riding, the anti-lock brake system may not work correctly. (See page 3-21.)

TIP _____

If the light does not come at all, or if the light does not go off after traveling 10 km/h (6 mi/h), have a Yamaha dealer check the vehicle.

WARNING _____

If the ABS warning light does not go off after traveling at a speed of 10 km/h (6 mi/h) or higher, or if the

Instrument and control functions

3

warning light comes on or flashes while riding, the brake system reverts to conventional braking. If either of the above occurs, or if the warning light does not come on at all, use extra caution to avoid possible wheel lock during emergency braking. Have a Yamaha dealer check the brake system and electrical circuits as soon as possible.

EAU73272

Traction control system indicator light “TCS”

In normal operation, this indicator light is off. When traction control has engaged, this indicator light will flash for a few seconds and then go off.

When the traction control system is turned off, this indicator light will come on.

If the traction control system becomes disabled while riding, or if a problem is detected in the traction control system, this indicator light and the engine trouble warning light will come on. (See page 3-22 for an explanation of the traction control system.)

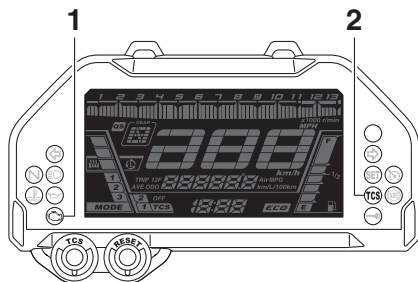

1. Engine trouble warning light “”
2. Traction control system indicator light “TCS”

EAU74091

Shift indicator light

This indicator light can be set to come on and go off at select engine speeds. (See page 3-17.)

TIP

When the vehicle is turned on, the light should come on for a few seconds and then go off. If the light does not come on, or if the light remains on, have a Yamaha dealer check the vehicle.

EAU73120

Immobilizer system indicator light “”

When the key is turned to “OFF” and 30 seconds have passed, the indicator light will flash steadily to indicate the immobilizer system is enabled. After 24 hours have passed, the indicator light will stop flashing, however the immobilizer system is still enabled.

The electrical circuit of the indicator light can be checked by turning the key to “ON”. The indicator light should come on for a few seconds, and then go off.

If the indicator light does not come on initially when the key is turned to “ON”, if the indicator light remains on, or if the indicator light flashes in a pattern (if a problem is detected in the immobilizer system, the immobilizer system indicator light will flash in a pattern), have a Yamaha dealer check the vehicle.

EAU84291

TIP

If the immobilizer system indicator light flashes in the pattern, slowly 5 times then quickly 2 times, this could be caused by transponder interference. If this occurs, try the following.

1. Make sure there are no other immobilizer keys close to the main switch. Other immobilizer system keys may cause signal interference and prevent the engine from starting.
2. Use the code re-registering key to start the engine.
3. If the engine starts, turn it off, and try starting the engine with the standard keys.
4. If one or both of the standard keys do not start the engine, take the vehicle and all 3 keys to a Yamaha dealer to have the standard keys re-registered.

Cruise control system

This model is equipped with a cruise control system designed to maintain a set cruising speed.

The cruise control system operates only when riding in 4th, 5th or 6th gear at speeds between about 50 km/h (31 mi/h) and 160 km/h (100 mi/h).

EWA16341

⚠ WARNING

- **Improper use of the cruise control system may result in loss of control, which could lead to an accident. Do not activate the cruise control system in heavy traffic, poor weather conditions, or among winding, slippery, hilly, rough or gravel roads.**
- **When traveling uphill or downhill, the cruise control system may not be able to maintain the set cruising speed.**
- **To prevent accidentally activating the cruise control system, turn it off when not in use. Make sure that the cruise control system indicator light “A photograph of the motorcycle's instrument cluster. The speedometer is at the top with a scale from 0 to 120 km/h. Below it, there are several digital displays: 'TRIP 123', 'Ave SPD', 'MODE', 'TCS', 'ECO', and 'E'. On the right side of the cluster, there are two indicator lights: a 'SET' light and a cruise control symbol light. A white line with the number '1' points to the 'SET' light, and a white line with the number '2' points to the cruise control symbol light.**

1. Cruise control setting indicator light “SET”
2. Cruise control system indicator light “A close-up photograph of the cruise control control switch on the handlebar. The switch has a 'SELECT' button at the top, a 'RES+' button, and a 'SET-' button. Below these buttons is a power switch with a cruise control symbol. A white line with the number '1' points to the 'RES+/SET-' button, and a white line with the number '2' points to the power switch.



1. Cruise control setting switch “RES+/SET-”
2. Cruise control power switch “

3-8

Instrument and control functions

Activating and setting the cruise control system

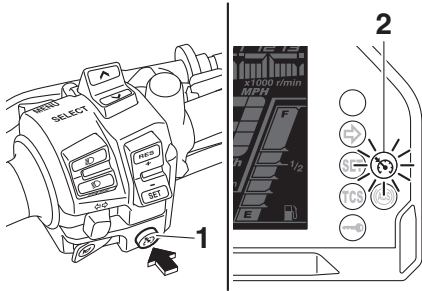
3

1. Push the cruise control power switch “A line drawing showing the left handlebar and instrument panel. On the handlebar, there is a switch labeled '1' with a power symbol. On the instrument panel, there is a light labeled '2' with a power symbol. The instrument panel also shows a tachometer with 'x1000 r/min' and 'MPH' scales, and a gear shift indicator with 'N', 'D', '1/2', 'E', and 'F' positions.

1. Cruise control power switch “
 2. Push the “SET-” side of the cruise control setting switch to activate the cruise control system. Your current traveling speed will become the set cruising speed. The cruise control setting indicator light “SET” will come on.

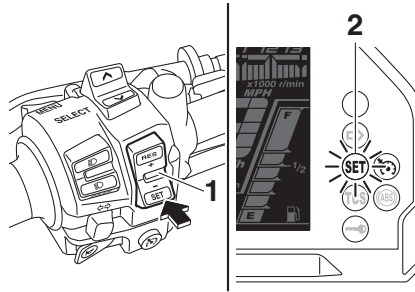

1. Cruise control setting switch “RES+/SET-”
2. Cruise control setting indicator light “SET”

Adjusting the set cruising speed

While the cruise control system is operating, push the “RES+” side of the cruise control setting switch to increase the set cruising speed or the “SET-” side to decrease the set speed.

TIP

Pushing the setting switch once will change the speed in increments of approximately 2.0 km/h (1.2 mi/h). Holding the “RES+” or “SET-” side of the cruise control setting switch down will increase or decrease the speed continuously until the switch is released.

You can also manually increase your traveling speed using the throttle. After you have accelerated, you can set a new cruising speed by pushing the “SET-” side of the setting switch. If you do not set a new cruising speed, when you return the throttle grip, the vehicle will decelerate to the previously set cruising speed.

Deactivating the cruise control system

Perform one of the following operations to cancel the set cruising speed. The “SET” indicator light will go off.

- Turn the throttle grip past the closed position in the deceleration direction.

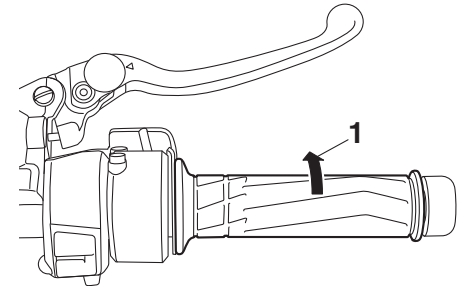

1. Deceleration direction

- Apply the front or rear brake.
- Squeeze the clutch lever.
- Use the shift pedal.

Push the power switch to turn off the cruise control system. The “” indicator light and the “SET” indicator light will go off.

TIP

Traveling speed decreases as soon as the cruise control system is deactivated; unless the throttle grip is turned.

Using the resume function

Push the “RES+” side of the cruise control setting switch to reactivate the cruise control system. The traveling speed will return to the previously set cruising speed. The “SET” indicator light will come on.

EWA16351



WARNING

It is dangerous to use the resume function when the previously set cruising speed is too high for current conditions.

TIP



Pushing the power switch while the system is operating will turn the system off completely and erase the previously set cruising speed. You will not be able to use the resume function until a new cruising speed has been set.

Automatic deactivation of the cruise control system

The cruise control system for this model is electronically controlled and is linked with the other control systems. The cruise control system will automatically become deactivated under the following conditions:

- The cruise control system is not able to maintain the set cruising speed.
- Wheel slip or wheel spin is detected. (If the traction control system has not been turned off, the traction control system will work.)
- The start/engine stop switch is set to the “” position.
- The engine stalls.
- The sidestand is lowered.

When traveling with a set cruising speed, if the cruise control system is deactivated under the above conditions, the “” indicator light will go off and the “SET” indicator light will flash for 4 seconds, and then go off.

When not traveling with a set cruising speed, if the start/engine stop switch is set to the “” position, the engine stalls, or the sidestand is lowered, then the “” indicator light will go off (the “SET” indicator light will not flash).

If the cruise control system is automatically deactivated, please stop and confirm that your vehicle is in good operating condition.

Before using the cruise control system again, activate it using the power switch.

TIP

In some cases, the cruise control system may not be able to maintain the set cruising speed when the vehicle is traveling uphill or downhill.

- When the vehicle is traveling uphill, the actual traveling speed may become lower than the set cruis-

Instrument and control functions

3

ing speed. If this occurs, accelerate to the desired traveling speed using the throttle.

- When the vehicle is traveling downhill, the actual traveling speed may become higher than the set cruising speed. If this occurs, the setting switch cannot be used to adjust the set cruising speed. To reduce the traveling speed, apply the brakes. When the brakes are applied, the cruise control system will become deactivated.

Multi-function meter unit

EAU85710

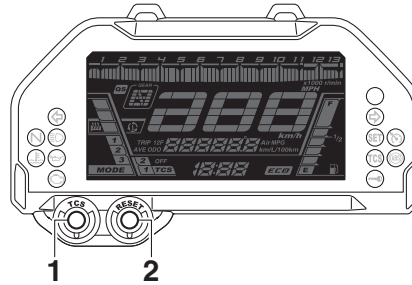

1. "TCS" button
2. "RESET" button

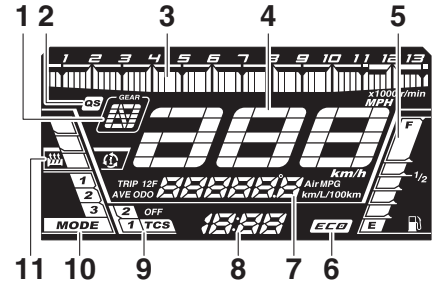

1. Transmission gear display
2. QS indicator
3. Tachometer
4. Speedometer
5. Fuel meter
6. Eco indicator "ECO"
7. Multi-function display
8. Clock
9. TCS display
10. Drive mode display
11. Grip warmer display

WARNING

EWA12423

Be sure to stop the vehicle before making any setting changes to the multi-function meter unit. Changing settings while riding can distract the operator and increase the risk of an accident.

Instrument and control functions

The multi-function meter unit is equipped with the following:

- speedometer
- tachometer
- clock
- fuel meter
- eco indicator
- transmission gear display
- drive mode display
- TCS display
- QS indicator
- grip warmer display
- multi-function display
- brightness and shift light control mode

TIP

The multi-function meter unit can be set to kilometers or miles. To switch between kilometers and miles, set the multi-function display to the odometer, and then push the “RESET” button for one second.

Speedometer

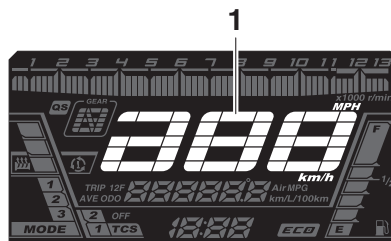

1. Speedometer

The speedometer shows your traveling speed.

Tachometer

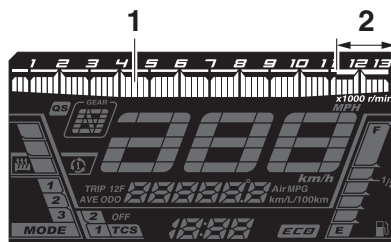

1. Tachometer
2. Tachometer red zone

The tachometer shows the engine speed.

ECA10032

NOTICE

Do not operate the engine in the tachometer red zone.
Red zone: 12000 r/min and above

Clock

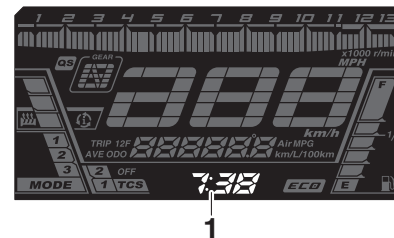

1. Clock

The clock uses a 12-hour time system.

To set the clock

1. Turn the vehicle on.
2. Push the “MENU” switch for one second, and the hour digits will start flashing.
3. Push the “SELECT” switch up or down to set the hours.

Instrument and control functions

3

4. Push the “MENU” switch, and the minute digits will start flashing.
5. Push the “SELECT” switch up or down to set the minutes.
6. Push the “MENU” switch to start the clock.

Fuel meter



1. Fuel meter

The fuel meter indicates the amount of fuel in the fuel tank. The display segments of the fuel meter disappear from “F” (full) towards “E” (empty) as the fuel level decreases. When the last segment starts flashing, approximately 4.0 L (1.06 US gal, 0.88 Imp.gal) of fuel remains. Refuel as soon as possible.

TIP

If a problem is detected in the electrical circuit, the fuel level segments will flash repeatedly. If this occurs, have a Yamaha dealer check the vehicle.

Eco indicator

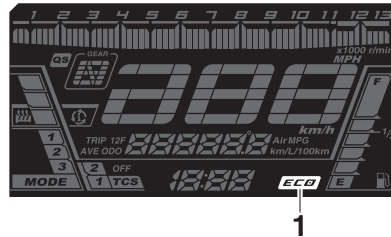

1. Eco indicator “ECO”

This indicator comes on when the vehicle is being operated in an environmentally friendly, fuel-efficient manner. The indicator goes off when the vehicle is stopped.

TIP

Consider the following tips to reduce fuel consumption:

- Avoid high engine speeds during acceleration.

- Travel at a constant speed.
- Select the transmission gear that is appropriate for the vehicle speed.

Transmission gear display

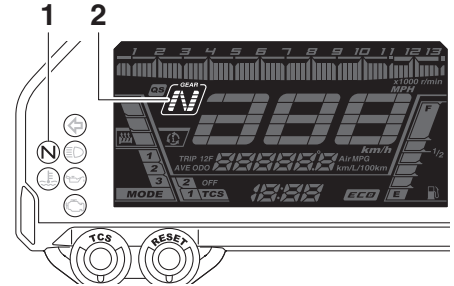

1. Neutral indicator light “N”
2. Transmission gear display

This display shows the selected gear. The neutral position is indicated by “N” and by the neutral indicator light.

Instrument and control functions

Drive mode display

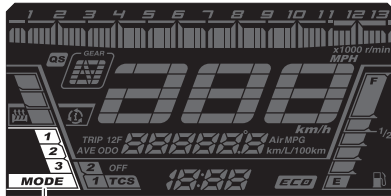

1. Drive mode display

This display indicates which drive mode has been selected: “1”, “2” or “3”. For more details on the modes and on how to select them, see page 3-19.

TCS display



1. TCS display

This display indicates which traction control system setting has been selected: “1”, “2”, or “OFF”. For more details on the TCS settings and how to select them, see page 3-22.

QS indicator

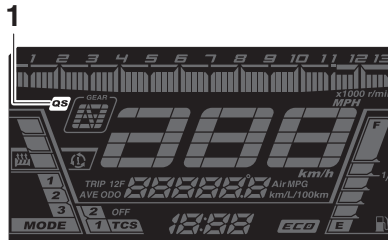

1. QS indicator

This indicator comes on when the quick shift system (page 3-20) is turned on.

Grip warmer display

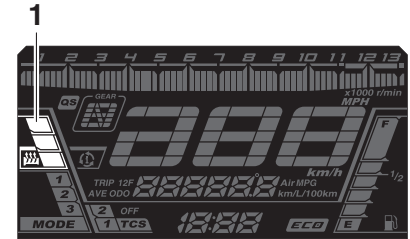

1. Grip warmer display

The grip warmers can be used when the engine is running. There are 4 grip warmer settings and 10 temperature levels.

Display	Setting
	Off
	Low
	Middle
	High

To change the grip warmer setting

1. Turn the vehicle on.

Instrument and control functions

3

2. Push the “MENU” switch to select the grip warmer display, and  will disappear.
3. Push the “SELECT” switch up or down to change the setting level.
4. Push the “MENU” switch.

TIP

The current grip warmer setting is saved when the vehicle is turned off.

ECA17932

NOTICE

- Be sure to wear gloves when using the grip warmers.
- Do not use the grip warmers in warm weather.
- If the handlebar grip or throttle grip becomes worn or damaged, stop using the grip warmers and replace the grips.

To set the grip warmer temperature levels

1. Turn the vehicle on.
2. Push the “MENU” switch to select the grip warmer display, and  will disappear.

3. Push the “MENU” switch for one second, and the grip warmer display and multi-function display will start flashing.
4. Push the “MENU” switch to change the setting level.
5. Push the “SELECT” switch up or down to set the temperature level.
6. Push the “MENU” switch for one second.

Multi-function display

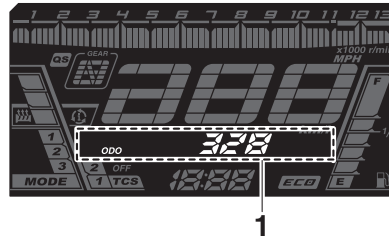

1. Multi-function display

The multi-function display can show the following:

- odometer (ODO)
- two tripmeters (TRIP 1 and TRIP 2)
- fuel reserve tripmeter (TRIP F)
- instantaneous fuel consumption

- average fuel consumption
- coolant temperature
- air temperature

TIP

- The odometer will lock at 999999.
- The tripmeters reset and continue counting after 9999.9 is reached.

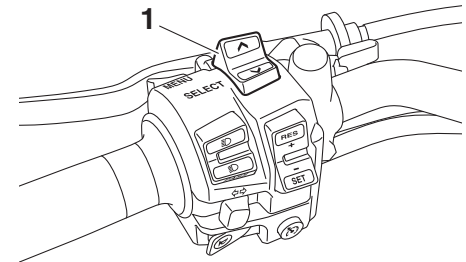

1. “SELECT” switch

Push the “SELECT” switch to change the display between the odometer “ODO”, the tripmeters “TRIP 1” and “TRIP 2”, instantaneous fuel consumption “km/L”, “L/100 km”, or “MPG”, average fuel consumption “AVE – – km/L”, “AVE – – L/100 km”, or “AVE – – MPG”, coolant temperature “°C”,

and air temperature “°C Air”. When pushing “^”, the display will change in the following order.

ODO → TRIP 1 → TRIP 2 → km/L, L/100 km, or MPG → AVE --.- km/L, AVE --.- L/100 km, or AVE --.- MPG → °C (coolant) → °C Air → ODO

When the last segment of the fuel meter starts flashing, the display changes to the fuel reserve tripmeter “TRIP F” and starts counting the distance traveled from that point. In this case, push “^” to change the display in the following order.

TRIP F → km/L, L/100 km, or MPG → AVE --.- km/L, AVE --.- L/100 km, or AVE --.- MPG → °C (coolant) → °C Air → ODO → TRIP 1 → TRIP 2 → TRIP F

TIP

- Push “v” to change the display in the opposite order.
- To reset a tripmeter, push the “RESET” button for one second.

- The fuel reserve tripmeter can be reset manually, or you can allow it to reset automatically after refueling and traveling about 5 km (3 mi).

Instantaneous fuel consumption

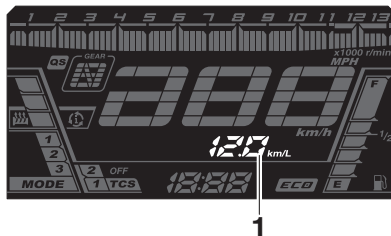

1. Instantaneous fuel consumption display

Instantaneous fuel consumption can be set to “km/L”, “L/100 km”, or “MPG”.

- “km/L”: the distance that can be traveled on 1.0 L of fuel
- “L/100 km”: the amount of fuel necessary to travel 100 km
- “MPG”: the distance that can be traveled on 1.0 Imp.gal of fuel

TIP

- To switch between “km/L”, “L/100 km”, and “MPG”, push the “RESET” button for one second.
- When traveling under 10 km/h (6 mi/h), “--.-” is displayed.

Average fuel consumption

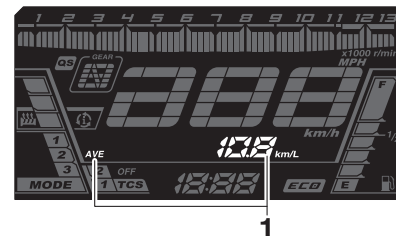

1. Average fuel consumption display

Average fuel consumption can be set to either “AVE --.- km/L”, “AVE --.- L/100 km”, or “AVE --.- MPG”.

- “AVE --.- km/L”: the average distance that can be traveled on 1.0 L of fuel
- “AVE --.- L/100 km”: the average amount of fuel necessary to travel 100 km

Instrument and control functions

- “AVE – –– MPG”: the average distance that can be traveled on 1.0 Imp.gal of fuel

TIP

- To reset the average fuel consumption, push the “RESET” button for one second.
- After resetting, “– ––” will be shown until the vehicle has traveled a sufficient distance.
- The display units cannot be switched between “km/L”, “L/100 km”, and “MPG” in this mode; change to the instantaneous fuel consumption mode first.

Coolant temperature

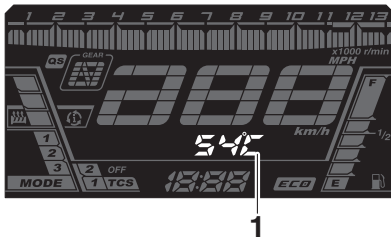

1. Coolant temperature display

The temperature of the engine coolant from 40 °C to 124 °C is shown in 1 °C increments.

If the message “Hi” flashes, stop the vehicle, then stop the engine and let it cool. (See page 6-36.)

TIP

- When the coolant temperature is below 40 °C, “Lo” will be displayed.
- The coolant temperature varies with changes in the weather and engine load.

Air temperature

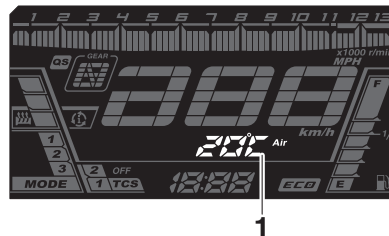

1. Air temperature display

The temperature of the air drawn into the intake system from –9 °C to 50 °C is shown in 1 °C increments.

TIP

- –9 °C will be displayed even if the air temperature falls below –9 °C.
- The temperature displayed may vary from the actual ambient temperature.

Brightness and shift light control mode

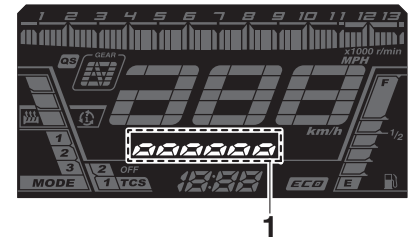

1. Brightness level display

This mode cycles through five control functions in the order listed below.

- Display brightness
- Shift light on / flash / off
- Shift light on r/min

Instrument and control functions

- Shift light off r/min
- Shift light brightness

TIP

The brightness level display shows the selected brightness level.

To adjust the display brightness

1. Turn the key to “OFF”.
2. Push and hold the “MENU” switch.
3. Turn the key to “ON”, and then release the “MENU” switch after five seconds.
4. Push the “SELECT” switch up or down to select the desired brightness level.
5. Push the “MENU” switch to confirm the selected brightness level. The control mode changes to the shift light on / flash / off setting function.

To set the shift light on / flash / off

1. Push the “SELECT” switch up or down to select one of the following style settings:

- On setting: the shift light will come on when the set engine speed is reached. This setting is selected when the indicator light is lit continuously.
 - Flash setting: the shift light will flash when the set engine speed is reached. This setting is selected when the indicator light flashes four times per second.
 - Off setting: the shift light is deactivated. This setting is selected when the indicator light flashes once every two seconds.
2. Push the “MENU” switch to confirm the selection. The control mode changes to the shift light on r/min setting function.

To set the shift light on r/min

The shift light can be set between 6000 r/min and 12000 r/min in increments of 200 r/min.

1. Push the “SELECT” switch up or down to select the desired engine speed for activating the indicator light.

2. Push the “MENU” switch to confirm the selected engine speed. The control mode changes to the shift light off r/min setting function.

To set the shift light off r/min

The shift light can be set between 6000 r/min and 12000 r/min in increments of 200 r/min. Be sure to set the off r/min to a higher engine speed than the on r/min setting, otherwise the shift light will not come on.

1. Push the “SELECT” switch up or down to select the desired engine speed for deactivating the indicator light.
2. Push the “MENU” switch to confirm the selected engine speed. The control mode changes to the shift light brightness setting function.

To adjust the shift light brightness

1. Push the “SELECT” switch up or down to select the desired shift light brightness level.
2. Push the “MENU” switch to confirm the selected brightness level and exit the control mode.

Instrument and control functions

D-mode (drive mode)

D-mode is an electronically controlled engine performance system.

EAU84550

EWA18440

WARNING

3 Do not change the drive mode while the vehicle is moving.

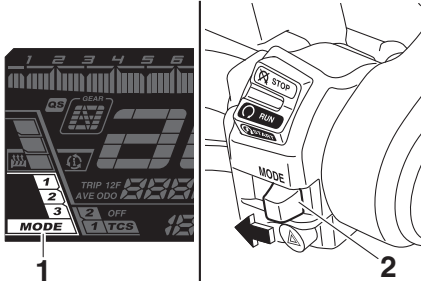

1. Drive mode display
2. Drive mode switch "MODE"

With the throttle grip closed, push the drive mode switch "MODE" to change the drive mode.

MODE 3

This mode offers response that is somewhat less sharp compared to MODE 2 for riding situations that require especially sensitive throttle operation.

MODE 2

This mode is suitable for various riding conditions. This mode allows the rider to enjoy smooth and sporty drivability from the low-speed range to the high-speed range.

MODE 1

This mode offers a sportier engine response in the low- to mid-speed range compared to MODE 2.

TIP

The current drive mode is saved when the vehicle is turned off.

Clutch lever

EAU12822

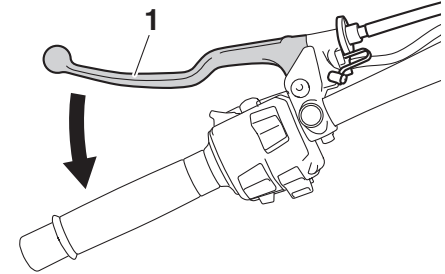

1. Clutch lever

The clutch lever is located on the left side of the handlebar. To disengage the clutch, pull the lever toward the handlebar grip. To engage the clutch, release the lever. The lever should be pulled rapidly and released slowly for smooth clutch operation.

The clutch lever is equipped with a clutch switch, which is part of the ignition circuit cut-off system. (See page 3-35.)

Shift pedal

EAU84321

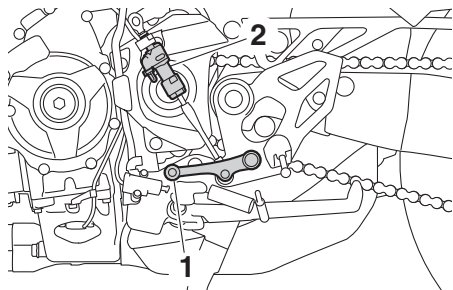

1. Shift pedal
2. Shift switch

The shift pedal is located on the left side of the engine. To shift the transmission to a higher gear, move the shift pedal up. To shift the transmission to a lower gear, move the shift pedal down. (See page 5-2.)

TIP

When the quick shift system is turned on, the shift switch senses shift pedal movement and allows for upshifting without operating the clutch lever.

Quick shift system

EAU84560

The quick shift system (QS) allows for full-throttle, clutch lever-less, electronically-assisted upshifts. When the shift switch detects motion in the shift pedal, engine power and drive torque are momentarily adjusted to allow the upshift to occur.

TIP

- QS operates when traveling at least 20 km/h (12 mi/h) with an engine speed of 4000 r/min or higher, and only when accelerating.
- QS does not operate when the clutch lever is pulled.

To turn the system off

1. Turn the main switch off.
2. Move the shift pedal upward so that the shift rod is partially retracted into the shift switch, and hold it in that position.

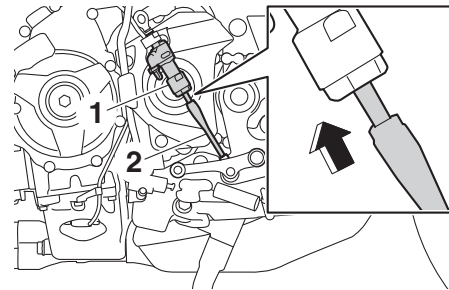

1. Shift switch
2. Rod

3. Turn the main switch on, and after 10 seconds release the shift pedal.
4. “**QS**” will disappear.

TIP

To turn on the quick shift system, perform the same procedure.

Instrument and control functions

EAU26826

Brake lever

The brake lever is located on the right side of the handlebar. To apply the front brake, pull the lever toward the throttle grip.

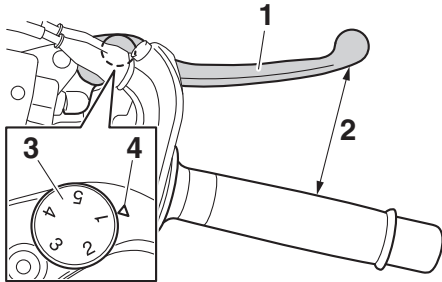

1. Brake lever
2. Distance
3. Brake lever position adjusting dial
4. Match mark

The brake lever is equipped with a brake lever position adjusting dial. To adjust the distance between the brake lever and the throttle grip, slightly pull the brake lever away from the throttle grip and rotate the adjusting dial. Make sure the setting number on the adjusting dial aligns with the match mark on the brake lever.

EAU12944

Brake pedal

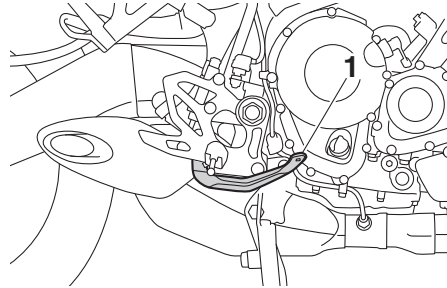

1. Brake pedal

The brake pedal is located on the right side of the motorcycle. To apply the rear brake, press down on the brake pedal.

EAU84570

ABS

The anti-lock brake system (ABS) acts on the front and rear brakes independently.

EWA16051

WARNING

Always keep a sufficient distance from the vehicle ahead to match the riding speed even with ABS.

- The ABS performs best with long braking distances.
- On certain surfaces, such as rough or gravel roads, the braking distance may be longer with the ABS than without.

How to operate the brakes

Operate the brake lever and brake pedal the same as you would conventional brakes. If wheel slip is detected while braking, ABS will activate and a pulsating sensation may be felt at the brake lever or brake pedal. Continue to apply the brakes and let the ABS work. Do not pump the brakes as this will reduce braking effectiveness.

- The ABS performs a self-check when you first start off. During this time a clicking noise from the hydraulic unit may be audible, and if the brake lever or brake pedal is applied a vibration can be felt, but this is not a malfunction.
- The brake system will revert to a conventional brake system in case of ABS malfunction.

ECA20100

NOTICE

Be careful not to damage the wheel sensor or wheel sensor rotor; otherwise, improper performance of the ABS will result.

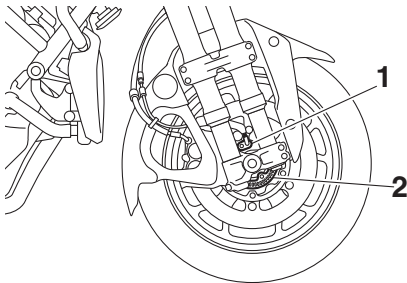

1. Front wheel sensor
2. Front wheel sensor rotor

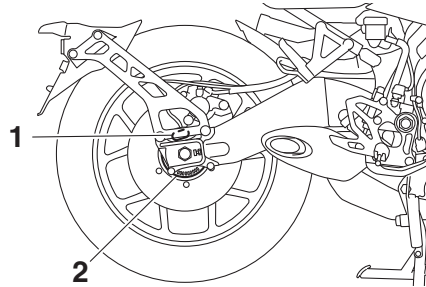

1. Rear wheel sensor
2. Rear wheel sensor rotor

Traction control system

EAU76317

The traction control system (TCS) helps maintain traction when accelerating on slippery surfaces, such as unpaved or wet roads. If sensors detect that the rear wheel is starting to slip (uncontrolled spinning), the traction control system assists by regulating engine power as needed until traction is restored.

3

EWA15433

⚠ WARNING

The traction control system is not a substitute for riding appropriately for the conditions. Traction control cannot prevent loss of traction due to excessive speed when entering turns, when accelerating hard at a sharp lean angle, or while braking, and cannot prevent front wheel slipping. As with any vehicle, approach surfaces that may be slippery with caution and avoid especially slippery surfaces.

Instrument and control functions

3

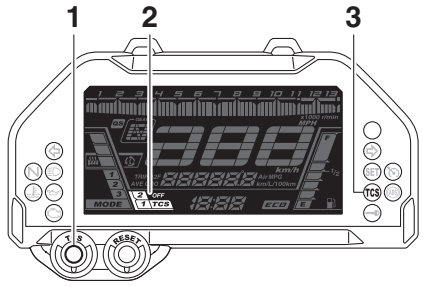

1. “TCS” button
2. TCS display
3. Traction control system indicator light “TCS”

The “TCS” indicator light flashes when traction control has engaged. You may notice slight changes in engine and exhaust sounds when the system has engaged.

The “TCS” indicator light comes on when traction control has been turned off.

The TCS display indicates the current TCS setting. There are three settings.

TCS “OFF”: Turns the traction control system off.

TCS “1”: Minimizes traction control system assist.

TCS “2”: Maximizes traction control assist; wheel spin is most strongly controlled.

TIP

- When the vehicle is turned on, traction control is turned on and set to “1” or “2” (whichever was last selected).
- Turn the traction control system off to help free the rear wheel if the vehicle gets stuck in mud, sand, or other soft surfaces.

ECA16801

NOTICE

Use only the specified tires. (See page 6-16.) Using different sized tires will prevent the traction control system from controlling tire rotation accurately.

Setting the traction control system

EWA15441

WARNING

Be sure to stop the vehicle before making any setting changes to the traction control system. Changing

settings while riding can distract the operator and increase the risk of an accident.

TCS settings can be changed only when the vehicle is stopped and the throttle closed.

- Push the “TCS” button to change between TCS settings “1” and “2”.
- Push the button for two seconds to turn the traction control system off.
- Push the button again to turn traction control back on (TCS will return to the previous setting).

Resetting the traction control system

The traction control system will automatically disable when:

- a wheel comes off the ground while riding.
- excessive rear wheel spin is detected while riding.
- a wheel is rotated by external forces with the vehicle power on (such as when performing maintenance).

If the traction control system is disabled, both the “TCS” indicator light and the “” warning light will come on.

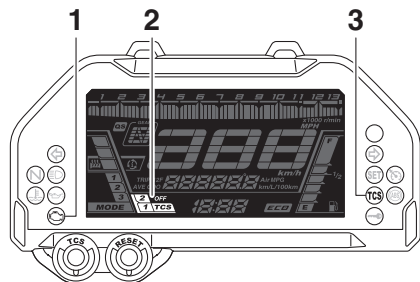

1. Engine trouble warning light “”
2. TCS display
3. Traction control system indicator light “TCS”

Should this occur, try resetting the system as follows.

1. Stop the vehicle and turn the vehicle off.
2. Wait a few seconds and then turn the vehicle back on.
3. The “TCS” indicator light should turn off and the system be enabled.

TIP _____
If the “TCS” indicator light remains on after resetting, the vehicle may still be ridden; however, have a Yamaha dealer check the vehicle as soon as possible.

4. Have a Yamaha dealer check the vehicle and turn off the “” warning light.

Fuel tank cap

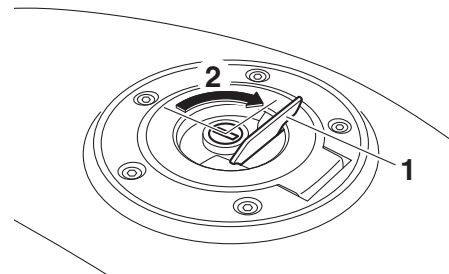

1. Fuel tank cap lock cover
2. Unlock.

To open the fuel tank cap

Open the fuel tank cap lock cover, insert the key into the lock, and then turn it 1/4 turn clockwise. The lock will be released and the fuel tank cap can be opened.

To close the fuel tank cap

With the key still inserted in the lock, push down the fuel tank cap. Turn the key 1/4 turn counterclockwise, remove it, and then close the lock cover.

Instrument and control functions

TIP _____

The fuel tank cap cannot be closed unless the key is in the lock. In addition, the key cannot be removed if the cap is not properly closed and locked.

3

⚠ WARNING _____

EWA11092

Make sure that the fuel tank cap is properly closed after filling fuel. Leaking fuel is a fire hazard.

Fuel

Make sure there is sufficient gasoline in the tank.

EAU13222

EWA10882

⚠ WARNING _____

Gasoline and gasoline vapors are extremely flammable. To avoid fires and explosions and to reduce the risk of injury when refueling, follow these instructions.

1. Before refueling, turn off the engine and be sure that no one is sitting on the vehicle. Never refuel while smoking, or while in the vicinity of sparks, open flames, or other sources of ignition such as the pilot lights of water heaters and clothes dryers.
2. Do not overfill the fuel tank. When refueling, be sure to insert the pump nozzle into the fuel tank filler hole. Stop filling when the fuel reaches the bottom of the filler tube. Because fuel expands when it heats up, heat from the engine or the sun can cause fuel to spill out of the fuel tank.

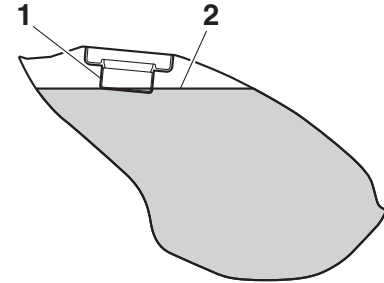

1. Fuel tank filler tube
2. Maximum fuel level

3. Wipe up any spilled fuel immediately. **NOTICE: Immediately wipe off spilled fuel with a clean, dry, soft cloth, since fuel may deteriorate painted surfaces or plastic parts.** [ECA10072]
4. Be sure to securely close the fuel tank cap.

EWA15152

⚠ WARNING _____

Gasoline is poisonous and can cause injury or death. Handle gasoline with care. Never siphon gasoline by mouth. If you should swallow some gasoline or inhale a lot of gasoline vapor, or get some gasoline in your eyes, see your doctor immedi-

ately. If gasoline spills on your skin, wash with soap and water. If gasoline spills on your clothing, change your clothes.

EAU75300

Recommended fuel:

Premium unleaded gasoline (Gasohol [E10] acceptable)

Fuel tank capacity:

18 L (4.8 US gal, 4.0 Imp.gal)

Fuel reserve amount:

4.0 L (1.06 US gal, 0.88 Imp.gal)

ECA11401

NOTICE

Use only unleaded gasoline. The use of leaded gasoline will cause severe damage to internal engine parts, such as the valves and piston rings, as well as to the exhaust system.

**TIP**

- This mark identifies the recommended fuel for this vehicle as specified by European regulation (EN228).
- Check that gasoline nozzle has the same identifier when fueling.

Your Yamaha engine has been designed to use premium unleaded gasoline with a research octane number of 95 or higher. If knocking (or pinging) occurs, use a gasoline of a different brand. Use of unleaded fuel will extend spark plug life and reduce maintenance costs.

Gasohol

There are two types of gasohol: gasohol containing ethanol and that containing methanol. Gasohol containing ethanol can be used if the ethanol content does not exceed 10% (E10). Gasohol containing methanol is not recommended by Yamaha because it can cause damage to the fuel system or vehicle performance problems.

Instrument and control functions

Fuel tank overflow hose

EAU80200

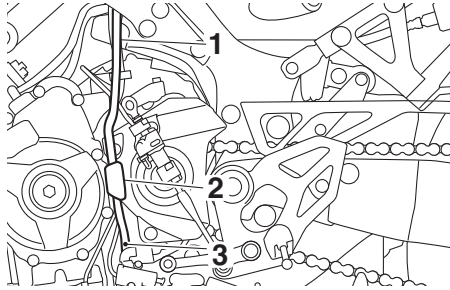

1. Fuel tank overflow hose
2. Guide
3. Paint mark

Before operating the vehicle:

- Check the fuel tank overflow hose connection.
- Check the fuel tank overflow hose for cracks or damage, and replace it if necessary.
- Make sure that the end of the fuel tank overflow hose is not blocked, and clean it if necessary.
- Make sure that the end of the fuel tank overflow hose is positioned as shown.

TIP _____
See page 6-11 for canister information.

Catalytic converter

EAU13434

This model is equipped with a catalytic converter in the exhaust system.

EWA10863

WARNING _____

The exhaust system is hot after operation. To prevent a fire hazard or burns:

- Do not park the vehicle near possible fire hazards such as grass or other materials that easily burn.
- Park the vehicle in a place where pedestrians or children are not likely to touch the hot exhaust system.
- Make sure that the exhaust system has cooled down before doing any maintenance work.
- Do not allow the engine to idle more than a few minutes. Long idling can cause a build-up of heat.

NOTICE

Use only unleaded gasoline. The use of leaded gasoline will cause unreparable damage to the catalytic converter.

ECA10702

Seats

Passenger seat

To remove the passenger seat

1. Open the seat lock cover, insert the key into the seat lock, and then turn the key counterclockwise.

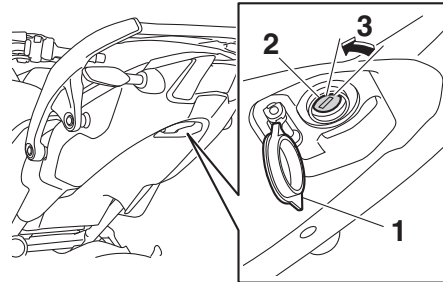

1. Seat lock cover
2. Seat lock
3. Unlock.

2. Lift the rear of the passenger seat and pull it backward.

EAU84580

To install the passenger seat

1. Insert the projection on the front of the passenger seat into the seat holder as shown, and then push the rear of the seat down to lock it in place.

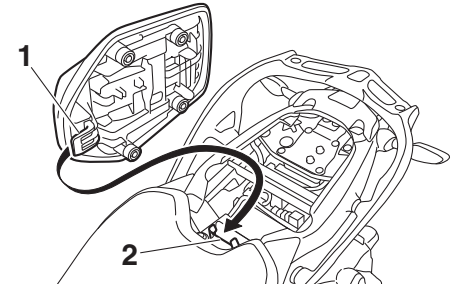

1. Projection
2. Seat holder

2. Remove the key.

Rider seat

To remove the rider seat

1. Remove the passenger seat, and then remove the hexagon wrench located on the bottom of the seat.

Instrument and control functions

EAU84590

3

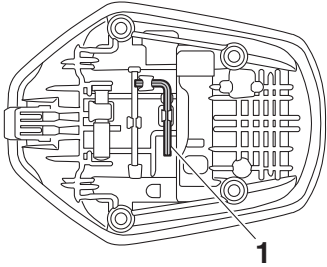

1. Hexagon wrench
2. Remove the bolts with the hexagon wrench.

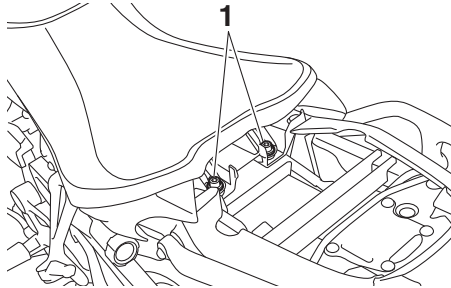

1. Bolt
3. Lift the rear of the rider seat and pull it backward.

To install the rider seat

1. Insert the projection on the front of the rider seat into the seat holder as shown, and then place the seat in the original position.

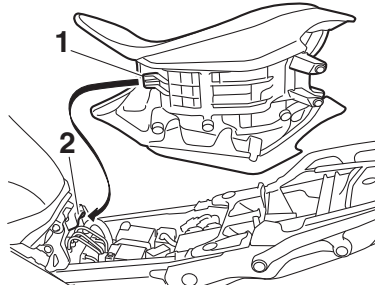

1. Projection
2. Seat holder
2. Install the bolts with the hexagon wrench.
3. Insert the hexagon wrench back into its holder on the passenger seat.
4. Install the passenger seat.

TIP

Make sure that the seats are properly secured before riding.

Helmet holding cable

A helmet holding cable is provided to allow you to secure helmet(s) to the vehicle.

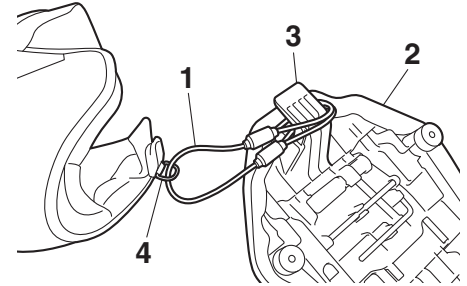

1. Helmet holding cable
2. Passenger seat
3. Projection
4. Helmet strap buckle

To secure a helmet with the helmet holding cable

1. Remove the passenger seat.
2. Remove the storage pouch and cable.

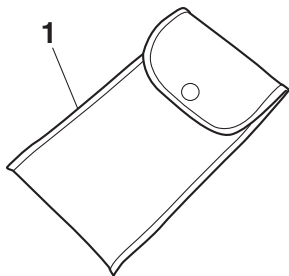

1. Storage pouch

3. Pass the helmet holding cable through the buckle on the helmet strap.
4. Loop the ends of the helmet holding cable around the projection on the passenger seat.
5. Install the passenger seat.
WARNING! Never ride with a helmet attached to the helmet holder, since the helmet may hit objects, causing loss of control and possibly an accident. [EWA10162]

Storage compartment

EAU14465

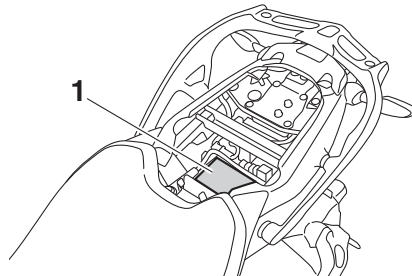

1. Storage compartment

The storage compartment is located under the passenger seat. (See page 3-28.)

When storing documents or other items in the storage compartment, be sure to wrap them in a plastic bag so that they will not get wet. When washing the vehicle, be careful not to let any water enter the storage compartment.

EWA10962

! WARNING

- Do not exceed the load limit of 1.5 kg (3 lb) for the storage compartment.

- Do not exceed the maximum load of 191 kg (421 lb) for the vehicle.

Instrument and control functions

Rear view mirrors

EAU39672

The rear view mirrors of this vehicle can be folded forward or backward for parking in narrow spaces. Fold the mirrors back to their original position before riding.

3

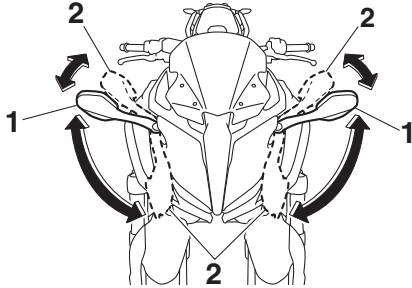

1. Riding position
2. Parking position

WARNING

EWA14372

Be sure to fold the rear view mirrors back to their original position before riding.

Adjusting the front fork

EAU84600

EWA10181

WARNING

Always adjust both fork legs equally, otherwise poor handling and loss of stability may result.

Each side of the front fork is equipped with a rebound damping force adjusting screw and compression damping force adjusting screw.

- When adjusting the damping force settings, turn the adjuster in direction (a) until it stops, and then count the clicks in direction (b).
- When turning a damping force adjuster in direction (a), the stop position and the 1 click position may be the same.
- Although a damping force adjuster may click beyond the stated minimum settings, such adjustments are ineffective and may damage the suspension.

NOTICE

To avoid damaging the mechanism, do not attempt to turn beyond the maximum or minimum settings.

Rebound damping force

To increase the rebound damping force and thereby harden the rebound damping, turn the adjusting screw on each side of the front fork in direction (a). To decrease the rebound damping force and thereby soften the rebound damping, turn the adjusting screw on each side of the front fork in direction (b).

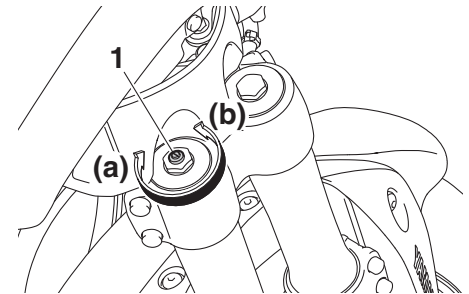

1. Rebound damping force adjusting screw

Rebound damping setting:

- Minimum (soft):
17 click(s) in direction (b)
- Standard:
13 click(s) in direction (b)
- Maximum (hard):
1 click(s) in direction (b)

Compression damping setting:

- Minimum (soft):
13 click(s) in direction (b)
- Standard:
8 click(s) in direction (b)
- Maximum (hard):
1 click(s) in direction (b)

Adjusting the shock absorber assembly

This shock absorber assembly is equipped with a spring preload adjusting knob and a rebound damping force adjusting screw.

3

NOTICE

To avoid damaging the mechanism, do not attempt to turn beyond the maximum or minimum settings.

Compression damping force

To increase the compression damping force and thereby harden the compression damping, turn the adjusting screw on each side of the front fork in direction (a). To decrease the compression damping force and thereby soften the compression damping, turn the adjusting screw on each side of the front fork in direction (b).

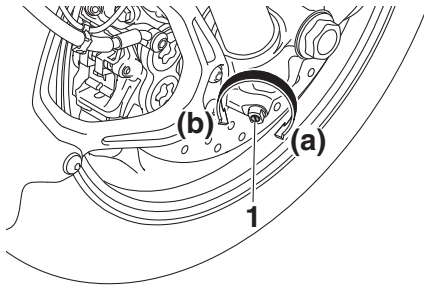

1. Compression damping force adjusting screw

Spring preload

To increase the spring preload and thereby harden the suspension, turn the adjusting knob in direction (a). To decrease the spring preload and thereby soften the suspension, turn the adjusting knob in direction (b).

Instrument and control functions

3

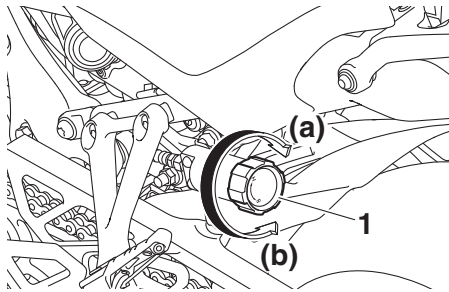

1. Spring preload adjusting knob

Spring preload setting:

Minimum (soft):

0 click(s) in direction (a)

Standard:

1 click(s) in direction (a)

Maximum (hard):

24 click(s) in direction (a)

TIP

When adjusting the spring preload setting, turn the adjuster in direction (b) until it stops, and then count the clicks in direction (a).

Rebound damping force

To increase the rebound damping force and thereby harden the rebound damping, turn the adjusting screw in

direction (a). To decrease the rebound damping force and thereby soften the rebound damping, turn the adjusting screw in direction (b).

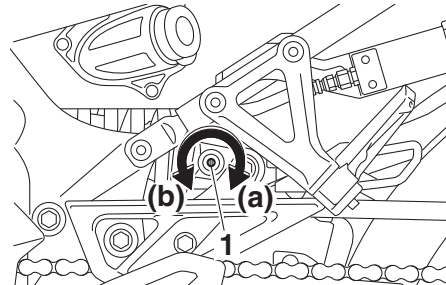

1. Rebound damping force adjusting screw

Rebound damping setting:

Minimum (soft):

2 4/5 turn(s) in direction (b)

Standard:

1 1/4 turn(s) in direction (b)

Maximum (hard):

0 turn(s) in direction (b)

TIP

- When adjusting the damping force settings, turn the adjuster in direction (a) until it stops, and then count the number of turns in direction (b).

- Although a damping force adjuster may turn beyond the stated minimum settings, such adjustments are ineffective and may damage the suspension.

EWA10222

⚠ WARNING

This shock absorber assembly contains highly pressurized nitrogen gas. Read and understand the following information before handling the shock absorber assembly.

- Do not tamper with or attempt to open the cylinder assembly.
- Do not subject the shock absorber assembly to an open flame or other high heat source. This may cause the unit to explode due to excessive gas pressure.
- Do not deform or damage the cylinder in any way. Cylinder damage will result in poor damping performance.

- Do not dispose of a damaged or worn-out shock absorber assembly yourself. Take the shock absorber assembly to a Yamaha dealer for any service.

Auxiliary DC jacks

EAU85720

ECA26610

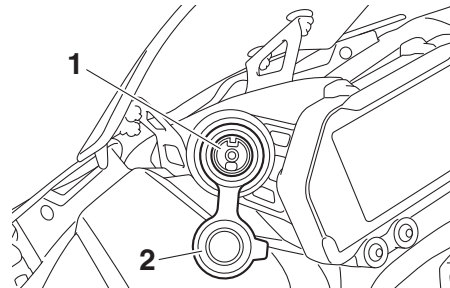

1. Auxiliary DC jack
2. Auxiliary DC jack cap

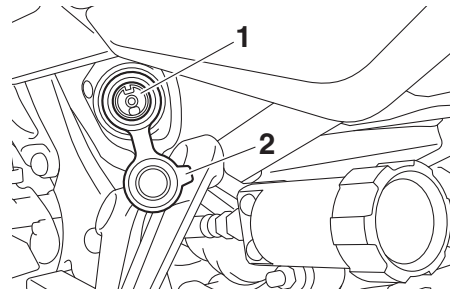

1. Auxiliary DC jack
2. Auxiliary DC jack cap

These power outlets provide 12-volt direct current electricity for a smart-phone charger or other accessory with the proper plug.

NOTICE

Do not draw power from a DC jack with the engine turned off. Do not connect any accessory which uses more than 12 W (1.0 A). Otherwise the battery may discharge or a fuse may blow.

To use an auxiliary DC jack

1. Start the engine. (See page 5-1.)
2. Turn the accessory off.
3. Open the auxiliary DC jack cap.
4. Insert the accessory power plug.
5. Turn the accessory on.

TIP

- When inserting or removing the accessory power plug, turn the accessory off.
- When the auxiliary DC jack is not being used, cover it with the cap.

EWA14361

⚠ WARNING

To prevent electrical shock or short-circuiting, make sure that the cap is installed when the auxiliary DC jack is not being used.

Instrument and control functions

Sidestand

EAU15306

The sidestand is located on the left side of the frame. Raise the sidestand or lower it with your foot while holding the vehicle upright.

TIP

The built-in sidestand switch is part of the ignition circuit cut-off system, which cuts the ignition in certain situations. (See the following section for an explanation of the ignition circuit cut-off system.)

EWA10242

WARNING

The vehicle must not be ridden with the sidestand down, or if the sidestand cannot be properly moved up (or does not stay up), otherwise the sidestand could contact the ground and distract the operator, resulting in a possible loss of control. Yamaha's ignition circuit cut-off system has been designed to assist the operator in fulfilling the responsibility of raising the sidestand before starting off. Therefore, check

this system regularly and have a Yamaha dealer repair it if it does not function properly.

EAU57952

Ignition circuit cut-off system

This system prevents in-gear engine starts unless the clutch lever is pulled and the sidestand is up. Also, it will stop the running engine should the sidestand be lowered while the transmission is in gear.

Periodically check this system via the following procedure.

TIP

- This check is most reliable if performed with a warmed-up engine.
 - See pages 3-2 and 3-3 for switch operation information.
-

Instrument and control functions

With the engine turned off:
1. Move the sidestand down.
2. Set engine stop switch to run position.
3. Turn main switch to on position.
4. Shift transmission into neutral.
5. Push the start switch.
Does the engine start?

⚠ WARNING _____
If a malfunction is found, have the vehicle inspected before riding.

YES **NO**

With the engine still running:
6. Move the sidestand up.
7. Pull the clutch lever.
8. Shift transmission into gear.
9. Move the sidestand down.
Does the engine stall?

The neutral switch may not be working.
The motorcycle should not be ridden until checked by a Yamaha dealer.

YES **NO**

After the engine has stalled:
10. Move the sidestand up.
11. Pull the clutch lever.
12. Push the start switch.
Does the engine start?

The sidestand switch may not be working.
The motorcycle should not be ridden until checked by a Yamaha dealer.

YES **NO**

The system is OK. **The motorcycle can be ridden.**

The clutch switch may not be working.
The motorcycle should not be ridden until checked by a Yamaha dealer.

For your safety – pre-operation checks

EAU15599

Inspect your vehicle each time you use it to make sure the vehicle is in safe operating condition. Always follow the inspection and maintenance procedures and schedules described in the Owner's Manual.

EWA11152

WARNING

Failure to inspect or maintain the vehicle properly increases the possibility of an accident or equipment damage. Do not operate the vehicle if you find any problem. If a problem cannot be corrected by the procedures provided in this manual, have the vehicle inspected by a Yamaha dealer.

4

Before using this vehicle, check the following points:

ITEM	CHECKS	PAGE
Fuel	<ul style="list-style-type: none">• Check fuel level in fuel tank.• Refuel if necessary.• Check fuel line for leakage.• Check fuel tank overflow hose for obstructions, cracks or damage, and check hose connection.	3-25, 3-27
Engine oil	<ul style="list-style-type: none">• Check oil level in engine.• If necessary, add recommended oil to specified level.• Check vehicle for oil leakage.	6-11
Coolant	<ul style="list-style-type: none">• Check coolant level in reservoir.• If necessary, add recommended coolant to specified level.• Check cooling system for leakage.	6-14
Front brake	<ul style="list-style-type: none">• Check operation.• If soft or spongy, have Yamaha dealer bleed hydraulic system.• Check brake pads for wear.• Replace if necessary.• Check fluid level in reservoir.• If necessary, add specified brake fluid to specified level.• Check hydraulic system for leakage.	6-21, 6-22

For your safety – pre-operation checks

ITEM	CHECKS	PAGE
Rear brake	<ul style="list-style-type: none"> • Check operation. • If soft or spongy, have Yamaha dealer bleed hydraulic system. • Check brake pads for wear. • Replace if necessary. • Check fluid level in reservoir. • If necessary, add specified brake fluid to specified level. • Check hydraulic system for leakage. 	6-21, 6-22
Clutch	<ul style="list-style-type: none"> • Check operation. • Lubricate cable if necessary. • Check lever free play. • Adjust if necessary. 	6-19
Throttle grip	<ul style="list-style-type: none"> • Make sure that operation is smooth. • Check throttle grip free play. • If necessary, have Yamaha dealer adjust throttle grip free play and lubricate cable and grip housing. 	6-16, 6-26
Control cables	<ul style="list-style-type: none"> • Make sure that operation is smooth. • Lubricate if necessary. 	6-25
Drive chain	<ul style="list-style-type: none"> • Check chain slack. • Adjust if necessary. • Check chain condition. • Lubricate if necessary. 	6-23, 6-25
Wheels and tires	<ul style="list-style-type: none"> • Check for damage. • Check tire condition and tread depth. • Check air pressure. • Correct if necessary. 	6-16, 6-19
Brake and shift pedals	<ul style="list-style-type: none"> • Make sure that operation is smooth. • Lubricate pedal pivoting points if necessary. 	6-26
Brake and clutch levers	<ul style="list-style-type: none"> • Make sure that operation is smooth. • Lubricate lever pivoting points if necessary. 	6-27
Centerstand, sidestand	<ul style="list-style-type: none"> • Make sure that operation is smooth. • Lubricate pivots if necessary. 	6-27

For your safety – pre-operation checks

ITEM	CHECKS	PAGE
Chassis fasteners	<ul style="list-style-type: none">• Make sure that all nuts, bolts and screws are properly tightened.• Tighten if necessary.	–
Instruments, lights, signals and switches	<ul style="list-style-type: none">• Check operation.• Correct if necessary.	–
Sidestand switch	<ul style="list-style-type: none">• Check operation of ignition circuit cut-off system.• If system is not working correctly, have Yamaha dealer check vehicle.	3-35

Read the Owner's Manual carefully to become familiar with all controls. If there is a control or function you do not understand, ask your Yamaha dealer.

EWA10272



Failure to familiarize yourself with the controls can lead to loss of control, which could cause an accident or injury.

TIP

This model is equipped with:

- a lean angle sensor. This sensor stops the engine in case of a vehicle turnover. If this happens, the engine trouble warning light will come on, but this is not a malfunction. Turn the vehicle power off and then back on again to cancel the warning light. Failing to do so will prevent the engine from starting even though the engine will crank when pushing the start switch.
- an engine auto-stop system. The engine stops automatically if left idling for 20 minutes. If the engine stops, simply push the start switch to restart the engine.

Starting the engine

Under normal conditions, shift the transmission into neutral before starting the engine. To start the engine with the transmission in gear, the sidestand must be up and the clutch lever pulled.

To start the engine

1. Set the engine stop switch to “○”.
2. Turn the main switch to “ON”.
3. Confirm the following lights perform a circuit check.
 - Coolant temperature warning light
 - Oil level warning light
 - Engine trouble warning light
 - ABS warning light
 - Traction control system indicator light
 - Cruise control indicator lights
 - Shift indicator light
 - Immobilizer system indicator light

TIP

- The ABS warning light should go off after reaching a speed of 10 km/h (6 mi/h) or higher.

Operation and important riding points

- The neutral position indicator light should be on when the transmission is in neutral.

ECA24110

NOTICE

If a warning or indicator light does not work as described above, have a Yamaha dealer check the vehicle.

4. Push the start switch “(⊕)”.
Release the start switch when the engine starts, or after 5 seconds. Wait 10 seconds before pressing the switch again to allow battery voltage to restore.

ECA11043

NOTICE

For maximum engine life, never accelerate hard when the engine is cold!

Shifting

EAU84370

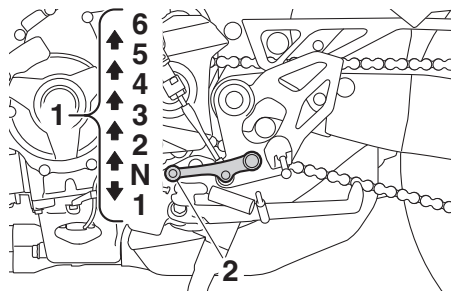

1. Gear positions
2. Shift pedal

Shifting gears lets you control the amount of engine power available for starting off, accelerating, climbing hills, etc.

The gear positions are shown in the illustration.

TIP

- To shift the transmission into the neutral position (N), press the shift pedal down repeatedly until it reaches the end of its travel, and then slightly raise it.

- This model is equipped with a quick shift system. (See page 3-20.)

ECA23990

NOTICE

- Even with the transmission in the neutral position, do not coast for long periods of time with the engine off, and do not tow the motorcycle for long distances. The transmission is properly lubricated only when the engine is running. Inadequate lubrication may damage the transmission.
- Except when upshifting with the quick shift system, always use the clutch while changing gears to avoid damaging the engine, transmission, and drive train, which are not designed to withstand the shock of forced shifting.

EAU85370

To start out and accelerate

1. Pull the clutch lever to disengage the clutch.

Operation and important riding points

2. Shift the transmission into first gear. The neutral indicator light should go out.
3. Open the throttle gradually, and at the same time, release the clutch lever slowly.
4. After starting out, close the throttle, and at the same time, quickly pull the clutch lever in.
5. Shift the transmission into second gear. (Make sure not to shift the transmission into the neutral position.)
6. Open the throttle part way and gradually release the clutch lever.
7. Follow the same procedure when shifting to the next higher gear.

EAU85380

To decelerate

1. Release the throttle and apply both the front and the rear brakes smoothly to slow the motorcycle.
2. As the vehicle decelerates, shift to a lower gear.

3. When the engine is about to stall or runs roughly, pull the clutch lever in, use the brakes to slow the motorcycle, and continue to downshift as necessary.
4. Once the motorcycle has stopped, the transmission can be shifted into the neutral position. The neutral indicator light should come on and then the clutch lever can be released.

EWA17380

WARNING

- **Improper braking can cause loss of control or traction. Always use both brakes and apply them smoothly.**
- **Make sure that the motorcycle and the engine have sufficiently slowed before shifting to a lower gear. Engaging a lower gear when the vehicle or engine speed is too high could make the rear wheel lose traction or the engine to over-rev. This could cause loss of control, an**

accident and injury. It could also cause engine or drive train damage.

Operation and important riding points

5

Tips for reducing fuel consumption

EAU16811

Fuel consumption depends largely on your riding style. Consider the following tips to reduce fuel consumption:

- Shift up swiftly, and avoid high engine speeds during acceleration.
- Do not rev the engine while shifting down, and avoid high engine speeds with no load on the engine.
- Turn the engine off instead of letting it idle for an extended length of time (e.g., in traffic jams, at traffic lights or at railroad crossings).

Engine break-in

EAU16842

There is never a more important period in the life of your engine than the period between 0 and 1600 km (1000 mi). For this reason, you should read the following material carefully.

Since the engine is brand new, do not put an excessive load on it for the first 1600 km (1000 mi). The various parts in the engine wear and polish themselves to the correct operating clearances. During this period, prolonged full-throttle operation or any condition that might result in engine overheating must be avoided.

EAU17094

0–1000 km (0–600 mi)

Avoid prolonged operation above 5600 r/min. **NOTICE: After 1000 km (600 mi) of operation, the engine oil must be changed and the oil filter cartridge or element replaced.** [ECA10303]

1000–1600 km (600–1000 mi)

Avoid prolonged operation above 6700 r/min.

1600 km (1000 mi) and beyond

The vehicle can now be operated normally.

ECA10311

NOTICE

- **Keep the engine speed out of the tachometer red zone.**
 - **If any engine trouble should occur during the engine break-in period, immediately have a Yamaha dealer check the vehicle.**
-

EAU17214

Parking

When parking, stop the engine, and then remove the key from the main switch.

EWA10312

WARNING

- **Since the engine and exhaust system can become very hot, park in a place where pedestrians or children are not likely to touch them and be burned.**
 - **Do not park on a slope or on soft ground, otherwise the vehicle may overturn, increasing the risk of a fuel leak and fire.**
 - **Do not park near grass or other flammable materials which might catch fire.**
-

Periodic maintenance and adjustment

EAU17246

EWA15123

EAU17303

Periodic inspection, adjustment, and lubrication will keep your vehicle in the safest and most efficient condition possible. Safety is an obligation of the vehicle owner/operator. The most important points of vehicle inspection, adjustment, and lubrication are explained on the following pages.

The intervals given in the periodic maintenance charts should be simply considered as a general guide under normal riding conditions. However, depending on the weather, terrain, geographical location, and individual use, the maintenance intervals may need to be shortened.

WARNING

EWA10322

Failure to properly maintain the vehicle or performing maintenance activities incorrectly may increase your risk of injury or death during service or while using the vehicle. If you are not familiar with vehicle service, have a Yamaha dealer perform service.

WARNING

Turn off the engine when performing maintenance unless otherwise specified.

- **A running engine has moving parts that can catch on body parts or clothing and electrical parts that can cause shocks or fires.**
 - **Running the engine while servicing can lead to eye injury, burns, fire, or carbon monoxide poisoning – possibly leading to death. See page 1-3 for more information about carbon monoxide.**
-

WARNING

EWA15461

Brake discs, calipers, drums, and linings can become very hot during use. To avoid possible burns, let brake components cool before touching them.

Emission controls not only function to ensure cleaner air, but are also vital to proper engine operation and maximum performance. In the following periodic maintenance charts, the services related to emissions control are grouped separately. These services require specialized data, knowledge, and equipment. Maintenance, replacement, or repair of the emission control devices and systems may be performed by any repair establishment or individual that is certified (if applicable). Yamaha dealers are trained and equipped to perform these particular services.

Tool kit

EAU85230

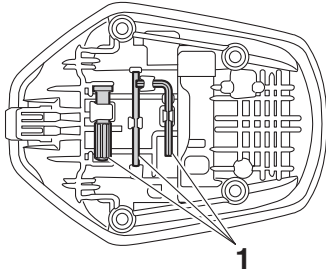

1. Tool kit

The tool kit is in the location shown. The information included in this manual and the tools provided in the tool kit are intended to assist you in the performance of preventive maintenance and minor repairs. However, a torque wrench and other tools are necessary to perform certain maintenance work correctly.

TIP _____

If you do not have the tools or experience required for a particular job, have your Yamaha dealer perform it for you.

Periodic maintenance and adjustment

EAU71033

Periodic maintenance charts

TIP

- Items marked with an asterisk should be performed by your Yamaha dealer because these items require special tools, data, and technical skills.
- From 50000 km (30000 mi), repeat the maintenance intervals starting from 10000 km (6000 mi).
- **The annual checks must be performed every year, except if a distance-based maintenance is performed instead.**

EAU71051

Periodic maintenance chart for the emission control system

NO.	ITEM	CHECK OR MAINTENANCE JOB	ODOMETER READING					ANNUAL CHECK
			1000 km (600 mi)	10000 km (6000 mi)	20000 km (12000 mi)	30000 km (18000 mi)	40000 km (24000 mi)	
1	* Fuel line	<ul style="list-style-type: none"> • Check fuel hoses for cracks or damage. • Replace if necessary. 		√	√	√	√	√
2	* Spark plugs	<ul style="list-style-type: none"> • Check condition. • Adjust gap and clean. 		√		√		
		<ul style="list-style-type: none"> • Replace. 			√		√	
3	* Valve clearance	<ul style="list-style-type: none"> • Check and adjust. 	Every 40000 km (24000 mi)					
4	* Fuel injection	<ul style="list-style-type: none"> • Check engine idle speed. 	√	√	√	√	√	√
		<ul style="list-style-type: none"> • Check and adjust synchronization. 		√	√	√	√	√
5	* Exhaust system	<ul style="list-style-type: none"> • Check for leakage. • Tighten if necessary. • Replace gaskets if necessary. 	√	√	√	√	√	

Periodic maintenance and adjustment

NO.	ITEM	CHECK OR MAINTENANCE JOB	ODOMETER READING					ANNUAL CHECK
			1000 km (600 mi)	10000 km (6000 mi)	20000 km (12000 mi)	30000 km (18000 mi)	40000 km (24000 mi)	
6	* Evaporative emission control system	<ul style="list-style-type: none"> • Check control system for damage. • Replace if necessary. 			√		√	
7	* Air induction system	<ul style="list-style-type: none"> • Check the air cut-off valve, reed valve, and hose for damage. • Replace any damaged parts if necessary. 		√	√	√	√	√

Periodic maintenance and adjustment

EAU71352

General maintenance and lubrication chart

NO.	ITEM	CHECK OR MAINTENANCE JOB	ODOMETER READING					ANNUAL CHECK
			1000 km (600 mi)	10000 km (6000 mi)	20000 km (12000 mi)	30000 km (18000 mi)	40000 km (24000 mi)	
1	* Diagnostic system check	<ul style="list-style-type: none"> Perform dynamic inspection using Yamaha diagnostic tool. Check the error codes. 	√	√	√	√	√	√
2	* Air filter element	<ul style="list-style-type: none"> Replace. 	Every 40000 km (24000 mi)					
3	Clutch	<ul style="list-style-type: none"> Check operation. Adjust. 	√	√	√	√	√	
4	* Front brake	<ul style="list-style-type: none"> Check operation, fluid level, and for fluid leakage. Replace brake pads if necessary. 	√	√	√	√	√	√
5	* Rear brake	<ul style="list-style-type: none"> Check operation, fluid level, and for fluid leakage. Replace brake pads if necessary. 	√	√	√	√	√	√
6	* Brake hoses	<ul style="list-style-type: none"> Check for cracks or damage. 		√	√	√	√	√
		<ul style="list-style-type: none"> Replace. 	Every 4 years					
7	* Brake fluid	<ul style="list-style-type: none"> Change. 	Every 2 years					
8	* Wheels	<ul style="list-style-type: none"> Check runout and for damage. Replace if necessary. 		√	√	√	√	
		<ul style="list-style-type: none"> Balance the front wheels. 	Whenever the tires or wheels have been changed or replaced.					
9	* Tires	<ul style="list-style-type: none"> Check tread depth and for damage. Replace if necessary. Check air pressure. Correct if necessary. 		√	√	√	√	√
10	* Wheel bearings	<ul style="list-style-type: none"> Check bearing for looseness or damage. 		√	√	√	√	

Periodic maintenance and adjustment

NO.	ITEM	CHECK OR MAINTENANCE JOB	ODOMETER READING					ANNUAL CHECK
			1000 km (600 mi)	10000 km (6000 mi)	20000 km (12000 mi)	30000 km (18000 mi)	40000 km (24000 mi)	
11	* Steering system	<ul style="list-style-type: none"> • Check bearing play and steering for roughness. 	√	√		√		
		<ul style="list-style-type: none"> • Lubricate with urea grease. 			√		√	
12	* Swingarm pivot bearings	<ul style="list-style-type: none"> • Check operation and for excessive play. 		√	√	√	√	
		<ul style="list-style-type: none"> • Lubricate with lithium-soap-based grease. 	Every 50000 km (30000 mi)					
13	Drive chain	<ul style="list-style-type: none"> • Check chain slack, alignment and condition. • Adjust and lubricate chain with a special O-ring chain lubricant thoroughly. 	Every 1000 km (600 mi) and after washing the motorcycle, riding in the rain or riding in wet areas					
14	* Chassis fasteners	<ul style="list-style-type: none"> • Make sure that all nuts, bolts and screws are properly tightened. 		√	√	√	√	√
15	Brake lever pivot shaft	<ul style="list-style-type: none"> • Lubricate with silicone grease. 		√	√	√	√	√
16	Brake pedal pivot shaft	<ul style="list-style-type: none"> • Lubricate with lithium-soap-based grease. 		√	√	√	√	√
17	Clutch lever pivot shaft	<ul style="list-style-type: none"> • Lubricate with lithium-soap-based grease. 		√	√	√	√	√
18	Shift pedal pivot shaft	<ul style="list-style-type: none"> • Lubricate with lithium-soap-based grease. 		√	√	√	√	√
19	Sidestand, center-stand	<ul style="list-style-type: none"> • Check operation. • Lubricate with lithium-soap-based grease. 		√	√	√	√	√
20	* Sidestand switch	<ul style="list-style-type: none"> • Check operation and replace if necessary. 	√	√	√	√	√	√

Periodic maintenance and adjustment

NO.	ITEM	CHECK OR MAINTENANCE JOB	ODOMETER READING					ANNUAL CHECK
			1000 km (600 mi)	10000 km (6000 mi)	20000 km (12000 mi)	30000 km (18000 mi)	40000 km (24000 mi)	
21	* Front fork	<ul style="list-style-type: none"> • Check operation and for oil leakage. • Replace if necessary. 		√	√	√	√	
22	* Shock absorber assembly	<ul style="list-style-type: none"> • Check operation and for oil leakage. • Replace if necessary. 		√	√	√	√	
23	* Rear suspension relay arm and connecting arm pivoting points	<ul style="list-style-type: none"> • Check operation. 		√	√	√	√	
24	Engine oil	<ul style="list-style-type: none"> • Change (warm engine before draining). • Check oil level and vehicle for oil leakage. 	√	√	√	√	√	√
25	Engine oil filter cartridge	<ul style="list-style-type: none"> • Replace. 	√		√		√	
26	* Cooling system	<ul style="list-style-type: none"> • Check coolant level and vehicle for coolant leakage. 		√	√	√	√	√
		<ul style="list-style-type: none"> • Change. 	Every 3 years					
27	* Front and rear brake switches	<ul style="list-style-type: none"> • Check operation. 	√	√	√	√	√	√
28	* Moving parts and cables	<ul style="list-style-type: none"> • Lubricate. 		√	√	√	√	√
29	* Throttle grip housing and cable	<ul style="list-style-type: none"> • Check operation and free play. • Adjust the throttle cable free play if necessary. • Lubricate the throttle grip housing, cable and grip warmer wire. 		√	√	√	√	√

Periodic maintenance and adjustment

NO.	ITEM	CHECK OR MAINTENANCE JOB	ODOMETER READING					ANNUAL CHECK
			1000 km (600 mi)	10000 km (6000 mi)	20000 km (12000 mi)	30000 km (18000 mi)	40000 km (24000 mi)	
30	* Lights, signals and switches	<ul style="list-style-type: none"> • Check operation. • Adjust headlight beam. 	√	√	√	√	√	√

EAU72800

TIP

- Air filter
 - This model's air filter is equipped with a disposable oil-coated paper element, which must not be cleaned with compressed air to avoid damaging it.
 - The air filter element needs to be replaced more frequently when riding in unusually wet or dusty areas.
- Hydraulic brake service
 - Regularly check and, if necessary, correct the brake fluid level.
 - Every two years replace the internal components of the brake master cylinders and calipers, and change the brake fluid.
 - Replace the brake hoses every four years and if cracked or damaged.

Periodic maintenance and adjustment

Removing and installing the panel

EAU18752

The panel shown needs to be removed to perform some of the maintenance jobs described in this chapter. Refer to this section each time the panel needs to be removed and installed.

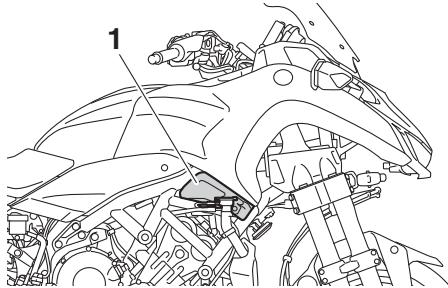

1. Panel A

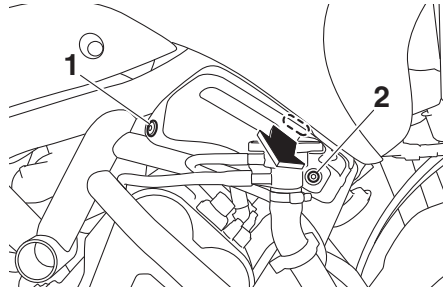

1. Quick fastener
2. Bolt

2. Pull the panel outward as shown.

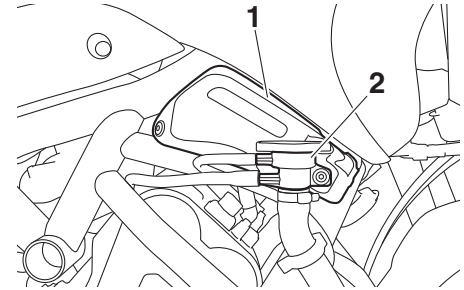

1. Panel A
2. Stay

3. Install the bolt and quick fastener.

To install the panel

1. Place the panel in the original position.

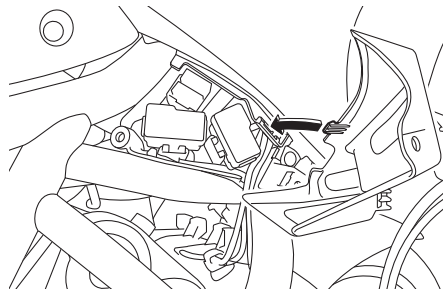

2. Place the radiator hose stay in the original position as shown.

6

Panel A

To remove the panel

1. Remove the quick fastener and bolt.

EAU84640

Checking the spark plugs

EAU19653

The spark plugs are important engine components, which should be checked periodically, preferably by a Yamaha dealer. Since heat and deposits will cause any spark plug to slowly erode, they should be removed and checked in accordance with the periodic maintenance and lubrication chart. In addition, the condition of the spark plugs can reveal the condition of the engine.

The porcelain insulator around the center electrode of each spark plug should be a medium-to-light tan (the ideal color when the vehicle is ridden normally), and all spark plugs installed in the engine should have the same color. If any spark plug shows a distinctly different color, the engine could be operating improperly. Do not attempt to diagnose such problems yourself. Instead, have a Yamaha dealer check the vehicle.

If a spark plug shows signs of electrode erosion and excessive carbon or other deposits, it should be replaced.

Specified spark plug:
NGK/MR9K9

Before installing a spark plug, the spark plug gap should be measured with a wire thickness gauge and, if necessary, adjusted to specification.

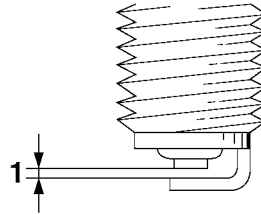

1. Spark plug gap

Spark plug gap:
0.8–0.9 mm (0.031–0.035 in)

Clean the surface of the spark plug gasket and its mating surface, and then wipe off any grime from the spark plug threads.

Tightening torque:
Spark plug:
13 N·m (1.3 kgf·m, 9.6 lb·ft)

TIP

If a torque wrench is not available when installing a spark plug, a good estimate of the correct torque is 1/4–1/2 turn past finger tight. However, the spark plug should be tightened to the specified torque as soon as possible.

ECA10841

NOTICE

Do not use any tools to remove or install the spark plug cap, otherwise the ignition coil coupler may get damaged. The spark plug cap may be difficult to remove because the rubber seal on the end of the cap fits tightly. To remove the spark plug cap, simply twist it back and forth while pulling it out; to install it, twist it back and forth while pushing it in.

Periodic maintenance and adjustment

Canister

EAU36112

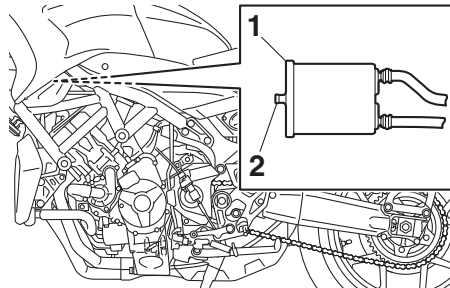

1. Canister
2. Canister breather

This model is equipped with a canister to prevent the discharging of fuel vapor into the atmosphere. Before operating this vehicle, make sure to check the following:

- Check each hose connection.
- Check each hose and canister for cracks or damage. Replace if damaged.
- Make sure that the canister breather is not blocked, and if necessary, clean it.

Engine oil

EAU1990F

The engine oil level should be checked regularly. In addition, the oil must be changed and the oil filter cartridge replaced at the intervals specified in the periodic maintenance chart.

Recommended engine oil:

See page 8-1.

Oil quantity:

Oil change:

2.40 L (2.54 US qt, 2.11 Imp.qt)

With oil filter removal:

2.70 L (2.85 US qt, 2.38 Imp.qt)

ECA11621

NOTICE

- **In order to prevent clutch slippage (since the engine oil also lubricates the clutch), do not mix any chemical additives. Do not use oils with a diesel specification of “CD” or oils of a higher quality than specified. In addition, do not use oils labeled “ENERGY CONSERVING II” or higher.**
- **Make sure that no foreign material enters the crankcase.**

To check the engine oil level

1. After warming up the engine, wait a few minutes for the oil level to settle for an accurate reading.
2. With the vehicle on a level surface, hold it upright for an accurate reading.
3. Look at the check window located at the bottom-right side of the crankcase.

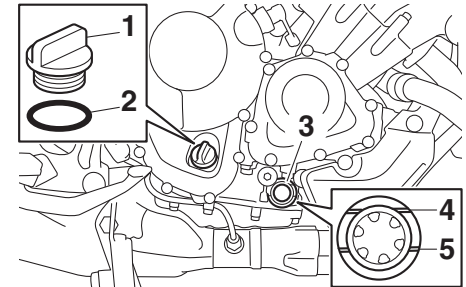

1. Engine oil filler cap
2. O-ring
3. Engine oil level check window
4. Maximum level mark
5. Minimum level mark

TIP

The engine oil should be between the minimum and maximum level marks.

Periodic maintenance and adjustment

- If the engine oil is at or below the minimum level mark, remove the oil filler cap and add oil.
- Check the engine oil filler cap O-ring. Replace if damaged.

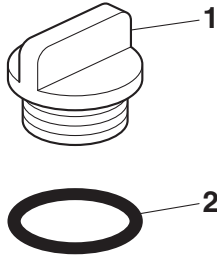

- Engine oil filler cap
- O-ring

6. Install the engine oil filler cap.

To change the engine oil (and filter)

- Start the engine and allow it to idle for a few minutes to warm up the oil, and then stop the engine.
- Place an oil pan under the engine to collect the used oil.
- Remove the engine oil filler cap, and then the engine oil drain bolt and gasket.

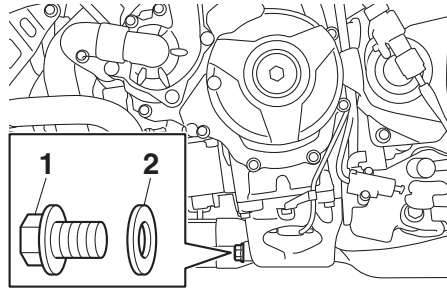

- Engine oil drain bolt
- Gasket

TIP

Skip steps 4–6 if the oil filter cartridge is not being replaced.

- Remove the oil filter cartridge with an oil filter wrench.

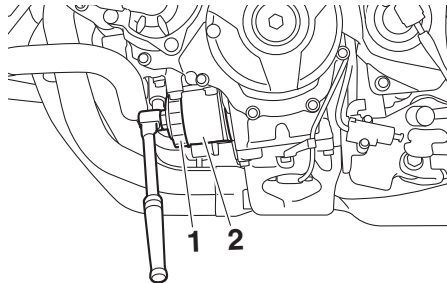

- Oil filter wrench
- Oil filter cartridge

TIP

An oil filter wrench is available at a Yamaha dealer.

- Apply a thin coat of clean engine oil to the O-ring of the new oil filter cartridge.

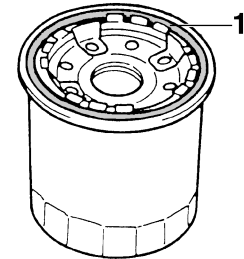

- O-ring

TIP

Make sure that the O-ring is properly seated.

- Install the new oil filter cartridge, and then tighten to the specified torque.

Periodic maintenance and adjustment

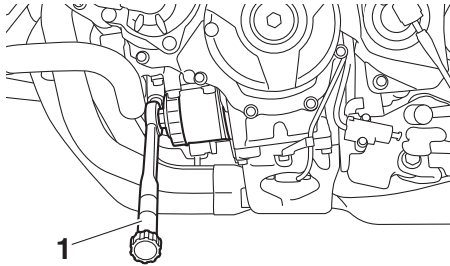

1. Torque wrench

Tightening torque:

Oil filter cartridge:
17 N·m (1.7 kgf·m, 13 lb·ft)

7. Install the engine oil drain bolt with a new gasket, and then tighten the bolt to the specified torque.

Tightening torque:

Engine oil drain bolt:
43 N·m (4.3 kgf·m, 32 lb·ft)

8. Pour the specified amount of the recommended oil into the crankcase.

TIP _____

Using a funnel is recommended.

9. After checking the engine oil filler cap O-ring, install the filler cap.

TIP _____

Wipe off any spilled oil before starting the engine.

10. Start the engine and let it idle while checking for oil leaks.

TIP _____

If any oil leaks are found which you cannot fix, have the vehicle inspected.

11. Stop the engine, wait a few minutes for the oil to settle, and then check the oil level one last time.
NOTICE: Do not operate the vehicle until you know that the engine oil level is sufficient. [ECA10012]

EAU85450

Why Yamalube

YAMALUBE oil is a Genuine YAMAHA Part born of the engineers' passion and belief that engine oil is an important liquid engine component. We form teams of specialists in the fields of mechanical engineering, chemistry, electronics and track testing, and have them develop the engine together with the oil it will use. Yamalube oils take full advantage of the base oil's qualities and blend in the ideal balance of additives to make sure the final oil clears our performance standards. Thus, Yamalube mineral, semisynthetic and synthetic oils have their own distinct characters and value. Yamaha's experience gained over many years of research and development into oil since the 1960's helps make Yamalube the best choice for your Yamaha engine.

YAMALUBE®

Periodic maintenance and adjustment

Coolant

EAUS1203

The coolant level should be checked regularly. In addition, the coolant must be changed at the intervals specified in the periodic maintenance chart.

Recommended coolant:

YAMALUBE coolant

Coolant quantity:

Coolant reservoir (max level mark):
0.25 L (0.26 US qt, 0.22 Imp.qt)

Radiator (including all routes):
1.93 L (2.04 US qt, 1.70 Imp.qt)

TIP

If genuine Yamaha coolant is not available, use an ethylene glycol antifreeze containing corrosion inhibitors for aluminum engines and mix with distilled water at a 1:1 ratio.

EAU20097

To check the coolant level

Since the coolant level varies with engine temperature, check when the engine is cold.

1. Park the vehicle on a level surface.

2. With the vehicle in an upright position, look at the coolant level in the reservoir.

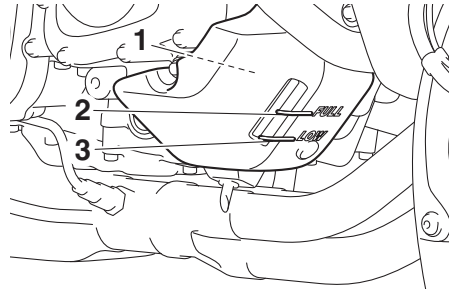

1. Coolant reservoir
2. Maximum level mark
3. Minimum level mark

3. If the coolant is at or below the minimum level mark, remove the coolant reservoir cap. **WARNING! Remove only the coolant reservoir cap. Never attempt to remove the radiator cap when the engine is hot.** [EWA15162]

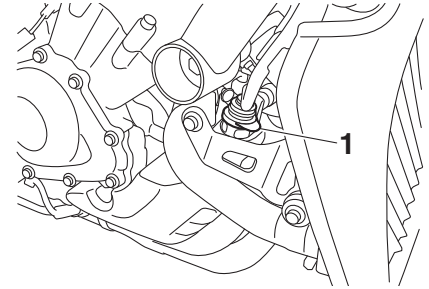

1. Coolant reservoir cap

4. Add coolant to the maximum level mark. **NOTICE: If coolant is not available, use distilled water or soft tap water instead. Do not use hard water or salt water since it is harmful to the engine. If water has been used instead of coolant, replace it with coolant as soon as possible, otherwise the cooling system will not be protected against frost and corrosion. If water has been added to the coolant, have a Yamaha dealer check the antifreeze content of the coolant as soon as possible, otherwise the effectiveness of the coolant will be reduced.** [ECA10473]

Periodic maintenance and adjustment

5. Install the coolant reservoir cap.

EAU33032

Changing the coolant

The coolant must be changed at the intervals specified in the periodic maintenance and lubrication chart. Have a Yamaha dealer change the coolant.

WARNING! Never attempt to remove the radiator cap when the engine is hot. [EWA10382]

Air filter element

EAU36765

The air filter element must be replaced at the intervals specified in the periodic maintenance and lubrication chart. Have a Yamaha dealer replace the air filter element.

Checking the engine idling speed

EAU44735

Check the engine idling speed and, if necessary, have it corrected by a Yamaha dealer.

Engine idling speed:
1100–1300 r/min

Checking the throttle grip free play

EAU21386

Measure the throttle grip free play as shown.

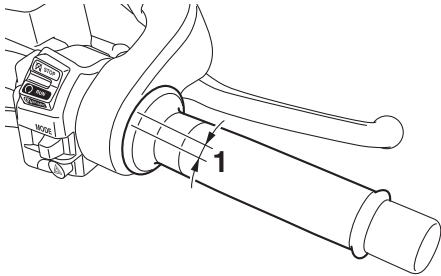

1. Throttle grip free play

Throttle grip free play:
3.0–5.0 mm (0.12–0.20 in)

Periodically check the throttle grip free play and, if necessary, have a Yamaha dealer adjust it.

Valve clearance

EAU21403

The valves are an important engine component, and since valve clearance changes with use, they must be checked and adjusted at the intervals specified in the periodic maintenance chart. Unadjusted valves can result in improper air-fuel mixture, engine noise, and eventually engine damage. To prevent this from occurring, have your Yamaha dealer check and adjust the valve clearance at regular intervals.

TIP

This service must be performed when the engine is cold.

Tires

EAU64412

Tires are the only contact between the vehicle and the road. Safety in all conditions of riding depends on a relatively small area of road contact. Therefore, it is essential to maintain the tires in good condition at all times and replace them at the appropriate time with the specified tires.

Tire air pressure

The tire air pressure should be checked and, if necessary, adjusted before each ride.

EWA10504

WARNING

Operation of this vehicle with improper tire pressure may cause severe injury or death from loss of control.

- The tire air pressure must be checked and adjusted on cold tires (i.e., when the temperature of the tires equals the ambient temperature).
- The tire air pressure must be adjusted in accordance with the riding speed and with the total

Periodic maintenance and adjustment

EWA10472

weight of rider, passenger, cargo, and accessories approved for this model.

Cold tire air pressure:

1 person:

Front:

225 kPa (2.25 kgf/cm², 33 psi)

Rear:

290 kPa (2.90 kgf/cm², 42 psi)

2 persons:

Front:

225 kPa (2.25 kgf/cm², 33 psi)

Rear:

290 kPa (2.90 kgf/cm², 42 psi)

Maximum load:

Vehicle:

191 kg (421 lb)

The vehicle's maximum load is the combined weight of the rider, passenger, cargo, and any accessories.

EWA10512

WARNING

Never overload your vehicle. Operation of an overloaded vehicle could cause an accident.

Tire inspection

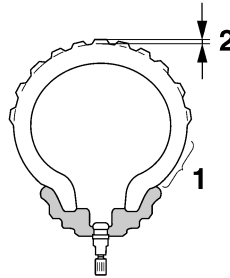

1. Tire sidewall
2. Tire tread depth

The tires must be checked before each ride. If the center tread depth reaches the specified limit, if the tire has a nail or glass fragments in it, or if the sidewall is cracked, have a Yamaha dealer replace the tire immediately.

Minimum tire tread depth (front and rear):

1.6 mm (0.06 in)

TIP

The tire tread depth limits may differ from country to country. Always comply with the local regulations.

WARNING

- Have a Yamaha dealer replace excessively worn tires. Besides being illegal, operating the vehicle with excessively worn tires decreases riding stability and can lead to loss of control.
- The replacement of all wheel and brake-related parts, including the tires, should be left to a Yamaha dealer, who has the necessary professional knowledge and experience to do so.
- Ride at moderate speeds after changing a tire since the tire surface must first be “broken in” for it to develop its optimal characteristics.

Tire information

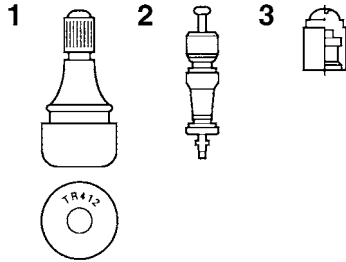

1. Tire air valve
2. Tire air valve core
3. Tire air valve cap with seal

This model is equipped with tubeless tires and tire air valves.

Tires age, even if they have not been used or have only been used occasionally. Cracking of the tread and sidewall rubber, sometimes accompanied by carcass deformation, is an evidence of ageing. Old and aged tires shall be checked by tire specialists to ascertain their suitability for further use.

EWA10902

! WARNING

- The front and rear tires should be of the same make and design, otherwise the handling

characteristics of the motorcycle may be different, which could lead to an accident.

- Always make sure that the valve caps are securely installed to prevent air pressure leakage.
- Use only the tire valves and valve cores listed below to avoid tire deflation during a ride.

After extensive tests, only the tires listed below have been approved for this model by Yamaha.

Front tire:

Size:
120/70 R 15 M/C 56V
Manufacturer/model:
BRIDGESTONE/A41F M

Rear tire:

Size:
190/55 R 17 M/C 75V
Manufacturer/model:
BRIDGESTONE/A41R M

FRONT and REAR:

Tire air valve:
TR412
Valve core:
#9100 (original)

! WARNING

This motorcycle is fitted with super-high-speed tires. Note the following points in order to make the most efficient use of these tires.

- Use only the specified replacement tires. Other tires may run the danger of bursting at super high speeds.
- Brand-new tires can have a relatively poor grip on certain road surfaces until they have been “broken in”. Therefore, it is advisable before doing any high-speed riding to ride conservatively for approximately 100 km (60 mi) after installing a new tire.
- The tires must be warmed up before a high-speed run.
- Always adjust the tire air pressure according to the operating conditions.

Periodic maintenance and adjustment

EAU61160

Cast wheels

To maximize the performance, durability, and safe operation of your vehicle, note the following points regarding the specified wheels.

- The wheel rims should be checked for cracks, bends, warpage or other damage before each ride. If any damage is found, have a Yamaha dealer replace the wheel. Do not attempt even the smallest repair to the wheel. A deformed or cracked wheel must be replaced.
- The front wheels should be balanced whenever either the tires or wheels have been changed or replaced. An unbalanced wheel can result in poor performance, adverse handling characteristics, and a shortened tire life.

EAU22083

Adjusting the clutch lever free play

Measure the clutch lever free play as shown.

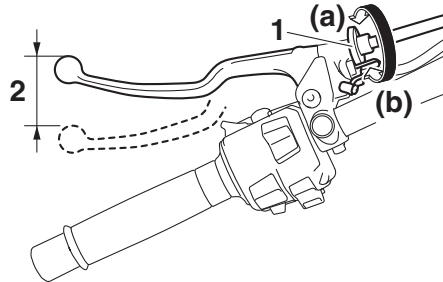

1. Clutch lever free play adjusting bolt
2. Clutch lever free play

Clutch lever free play:
10.0–15.0 mm (0.39–0.59 in)

Periodically check the clutch lever free play and, if necessary, adjust it as follows.

To increase the clutch lever free play, turn the clutch lever free play adjusting bolt in direction (a). To decrease the clutch lever free play, turn the adjusting bolt in direction (b).

TIP

If the specified free play cannot be obtained as described above or if the clutch does not operate correctly, have a Yamaha dealer check the internal clutch mechanism.

Checking the brake lever free play

EAU37914

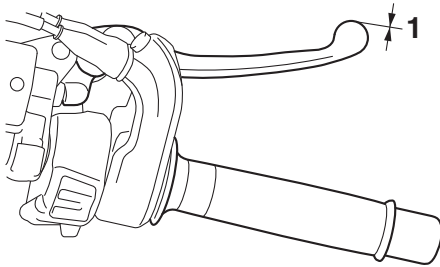

1. No brake lever free play

There should be no free play at the brake lever end. If there is free play, have a Yamaha dealer inspect the brake system.

EWA14212

! WARNING

A soft or spongy feeling in the brake lever can indicate the presence of air in the hydraulic system. If there is air in the hydraulic system, have a Yamaha dealer bleed the system before operating the vehicle. Air in the hydraulic system will diminish the

braking performance, which may result in loss of control and an accident.

Brake light switches

EAU36505

The brake light should come on just before braking takes effect. The brake light is activated by switches connected to the brake lever and brake pedal. Since the brake light switches are components of the anti-lock brake system, they should only be serviced by a Yamaha dealer.

Periodic maintenance and adjustment

Checking the front and rear brake pads

EAU22393

The front and rear brake pads must be checked for wear at the intervals specified in the periodic maintenance and lubrication chart.

Front brake pads

EAU22433

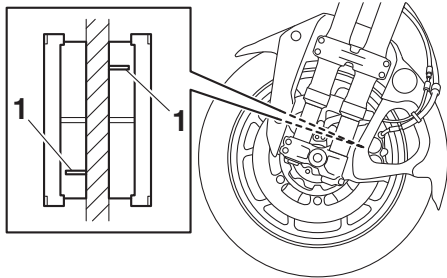

1. Brake pad wear indicator groove

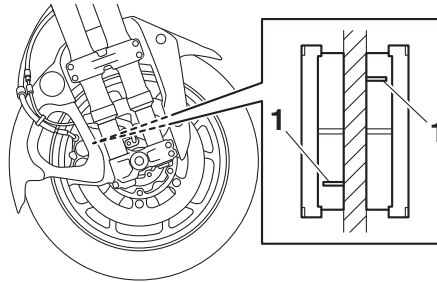

1. Brake pad wear indicator groove

Each front brake pad is provided with wear indicator grooves, which allow you to check the brake pad wear without having to disassemble the brake. To check the brake pad wear, check the wear indicator grooves. If a brake pad has worn to the point that the wear indicator grooves have almost disappeared, have a Yamaha dealer replace the brake pads as a set.

Rear brake pads

EAU46292

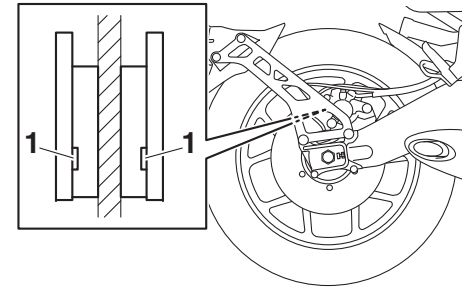

1. Brake pad wear indicator groove

Each rear brake pad is provided with wear indicator grooves, which allow you to check the brake pad wear without having to disassemble the brake. To check the brake pad wear, check the wear indicator grooves. If a brake pad has worn to the point that a wear indicator groove almost appears, have a Yamaha dealer replace the brake pads as a set.

Checking the brake fluid level EAU40262

Before riding, check that the brake fluid is above the minimum level mark. Check the brake fluid level with the top of the reservoir level. Replenish the brake fluid if necessary.

Front brake

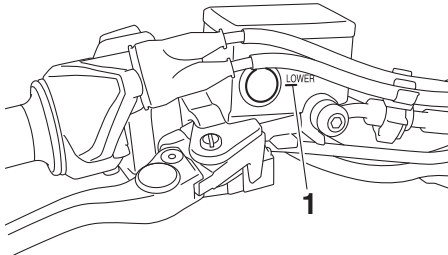

1. Minimum level mark

Rear brake

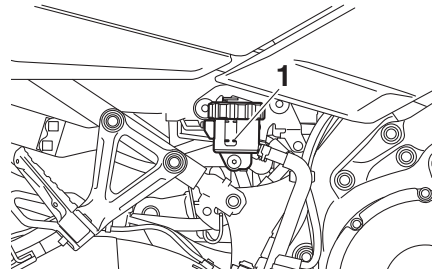

1. Minimum level mark

Specified brake fluid:
DOT 4

EWA16011

! WARNING

Improper maintenance can result in loss of braking ability. Observe these precautions:

- **Insufficient brake fluid may allow air to enter the brake system, reducing braking performance.**
- **Clean the filler cap before removing. Use only DOT 4 brake fluid from a sealed container.**

- **Use only the specified brake fluid; otherwise, the rubber seals may deteriorate, causing leakage.**
- **Refill with the same type of brake fluid. Adding a brake fluid other than DOT 4 may result in a harmful chemical reaction.**
- **Be careful that water or dust does not enter the brake fluid reservoir when refilling. Water will significantly lower the boiling point of the fluid and may result in vapor lock, and dirt may clog the ABS hydraulic unit valves.**

ECA17641

NOTICE

Brake fluid may damage painted surfaces or plastic parts. Always clean up spilled fluid immediately.

As the brake pads wear, it is normal for the brake fluid level to gradually go down. A low brake fluid level may indicate worn brake pads and/or brake system leakage; therefore, be sure to check the brake pads for wear and the brake system for leakage. If the brake

Periodic maintenance and adjustment

fluid level goes down suddenly, have a Yamaha dealer check the cause before further riding.

Changing the brake fluid

EAU22734

Have a Yamaha dealer change the brake fluid every 2 years. In addition, have the seals of the master cylinders and brake calipers, as well as the brake hoses replaced at the intervals listed below or sooner if they are damaged or leaking.

- Brake seals: every 2 years
- Brake hoses: every 4 years

Drive chain slack

EAU22762

The drive chain slack should be checked before each ride and adjusted if necessary.

To check the drive chain slack

EAU73530

1. Place the motorcycle on the centerstand.
2. Shift the transmission into the neutral position.
3. Measure the drive chain slack as shown.

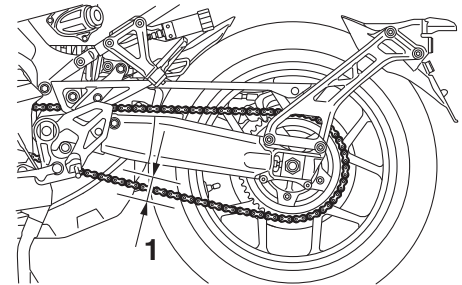

1. Drive chain slack

Drive chain slack:
5.0–15.0 mm (0.20–0.59 in)

Periodic maintenance and adjustment

4. If the drive chain slack is incorrect, adjust it as follows. **NOTICE: Improper drive chain slack will overload the engine as well as other vital parts of the motorcycle and can lead to chain slippage or breakage. If the drive chain slack is more than 50.0 mm (1.97 in), the chain can damage the frame, swingarm, and other parts. To prevent this from occurring, keep the drive chain slack within the specified limits.**

[ECA17791]

EAU49314

To adjust the drive chain slack

Consult a Yamaha dealer before adjusting the drive chain slack.

1. Take the motorcycle off the centerstand, and then put the side-stand down.
2. Loosen the axle nut and the locknut on each side of the swingarm.

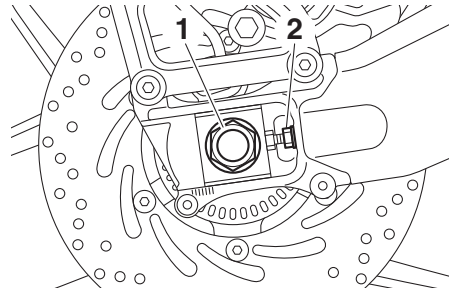

1. Axle nut
2. Locknut

3. Place the motorcycle on the centerstand.
4. To tighten the drive chain, turn the drive chain slack adjusting bolt on each side of the swingarm in direction (a). To loosen the drive chain, turn the adjusting bolt on each side of the swingarm in direction (b), and then push the rear wheel forward.

TIP

Using the alignment marks on each side of the swingarm, make sure that both drive chain pullers are in the same position for proper wheel alignment.

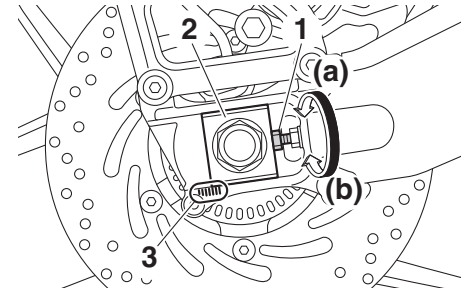

1. Drive chain slack adjusting bolt
2. Drive chain puller
3. Alignment mark

5. Take the motorcycle off the centerstand, and then put the side-stand down.
6. Tighten the axle nut, then the locknuts to the specified torques.

Tightening torques:

Axle nut:

150 N·m (15 kgf·m, 111 lb·ft)

Locknut:

16 N·m (1.6 kgf·m, 12 lb·ft)

7. Make sure that the drive chain pullers are in the same position, the drive chain slack is correct, and the drive chain moves smoothly.

Periodic maintenance and adjustment

Cleaning and lubricating the drive chain

EAU23026

The drive chain must be cleaned and lubricated at the intervals specified in the periodic maintenance and lubrication chart, otherwise it will quickly wear out, especially when riding in dusty or wet areas. Service the drive chain as follows.

ECA10584

NOTICE

The drive chain must be lubricated after washing the motorcycle, riding in the rain or riding in wet areas.

1. Clean the drive chain with kerosene and a small soft brush.
NOTICE: To prevent damaging the O-rings, do not clean the drive chain with steam cleaners, high-pressure washers or inappropriate solvents. [ECA11122]
2. Wipe the drive chain dry.
3. Thoroughly lubricate the drive chain with a special O-ring chain lubricant. **NOTICE: Do not use engine oil or any other lubricants for the drive chain, as they**

may contain substances that could damage the O-rings.

[ECA11112]

Checking and lubricating the cables

EAU23098

The operation of all control cables and the condition of the cables should be checked before each ride, and the cables and cable ends should be lubricated if necessary. If a cable is damaged or does not move smoothly, have a Yamaha dealer check or replace it. **WARNING! Damage to the outer housing of cables may result in internal rusting and cause interference with cable movement. Replace damaged cables as soon as possible to prevent unsafe conditions.** [EWA10712]

Recommended lubricant:

Yamaha cable lubricant or other suitable cable lubricant

Checking and lubricating the throttle grip and cable

EAU23115

The operation of the throttle grip should be checked before each ride. In addition, the cable should be lubricated by a Yamaha dealer at the intervals specified in the periodic maintenance chart.

The throttle cable is equipped with a rubber cover. Make sure that the cover is securely installed. Even though the cover is installed correctly, it does not completely protect the cable from water entry. Therefore, use care not to pour water directly onto the cover or cable when washing the vehicle. If the cable or cover becomes dirty, wipe clean with a moist cloth.

Checking and lubricating the brake and shift pedals

EAU44276

The operation of the brake and shift pedals should be checked before each ride, and the pedal pivots should be lubricated if necessary.

Brake pedal

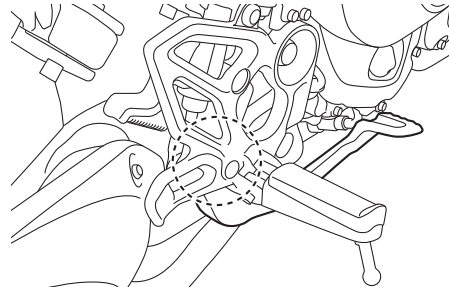

Shift pedal

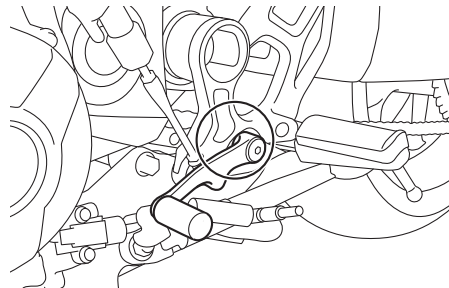

Recommended lubricant:
Lithium-soap-based grease

Periodic maintenance and adjustment

Checking and lubricating the brake and clutch levers

EAU23144

The operation of the brake and clutch levers should be checked before each ride, and the lever pivots should be lubricated if necessary.

Brake lever

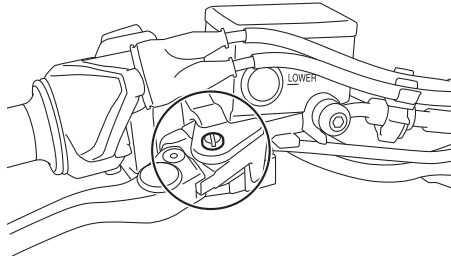

Clutch lever

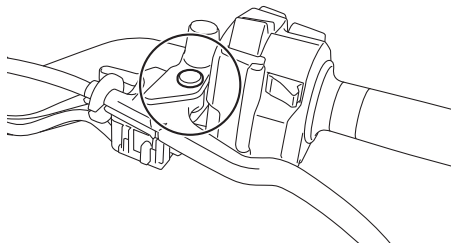

Recommended lubricants:

Brake lever:

Silicone grease

Clutch lever:

Lithium-soap-based grease

Checking and lubricating the centerstand and sidestand

EAU23215

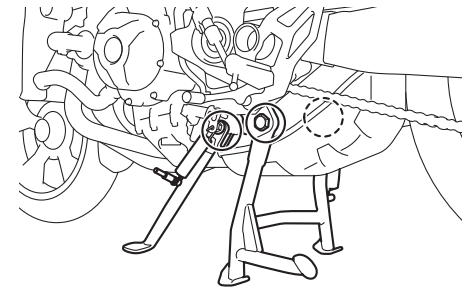

The operation of the centerstand and sidestand should be checked before each ride, and the pivots and metal-to-metal contact surfaces should be lubricated if necessary.

EWA10742

! WARNING

If the centerstand or sidestand does not move up and down smoothly, have a Yamaha dealer check or repair it. Otherwise, the centerstand or sidestand could contact the ground and distract the operator, resulting in a possible loss of control.

Recommended lubricant:
Lithium-soap-based grease

Lubricating the swingarm pivots

EAUM1653

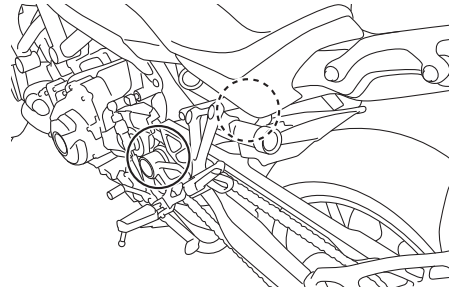

The swingarm pivots must be lubricated by a Yamaha dealer at the intervals specified in the periodic maintenance and lubrication chart.

Recommended lubricant:
Lithium-soap-based grease

Checking the front fork

EAU23273

The condition and operation of the front fork must be checked as follows at the intervals specified in the periodic maintenance and lubrication chart.

To check the condition

Check the inner tubes for scratches, damage and excessive oil leakage.

To check the operation

1. Place the vehicle on a level surface and hold it in an upright position. **WARNING! To avoid injury, securely support the vehicle so there is no danger of it falling over.** [EWA10752]
2. While applying the front brake, push down hard on the handlebars several times to check if the front fork compresses and rebounds smoothly.

Periodic maintenance and adjustment

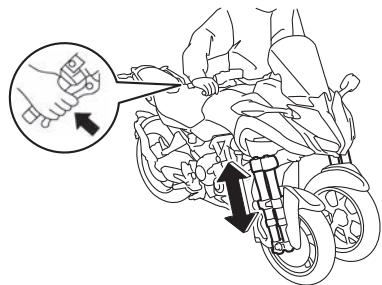

ECA10591

NOTICE

If any damage is found or the front fork does not operate smoothly, have a Yamaha dealer check or repair it.

Checking the steering

EAU84950

Worn or loose steering bearings may cause danger. Therefore, the operation of the steering must be checked by a Yamaha dealer at the intervals specified in the periodic maintenance chart.

Lubricating the steering bearings

EAU84960

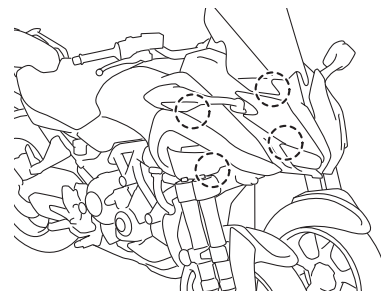

The steering bearings must be lubricated by a Yamaha dealer at the intervals specified in the periodic maintenance chart.

Recommended lubricant:
Urea grease

Checking the wheel bearings

EAU84970

The front and rear wheel bearings must be checked by a Yamaha dealer at the intervals specified in the periodic maintenance chart.

Battery

EAU50212

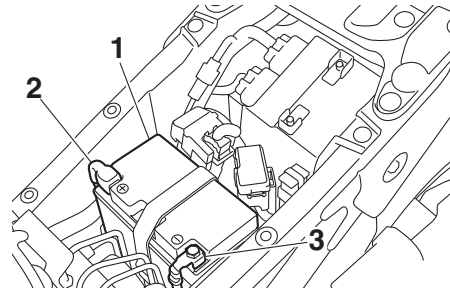

1. Battery
2. Positive battery lead (red)
3. Negative battery lead (black)

The battery is located under the rider seat. (See page 3-28.)

This model is equipped with a VRLA (Valve Regulated Lead Acid) battery. There is no need to check the electrolyte or to add distilled water. However, the battery lead connections need to be checked and, if necessary, tightened.

EWA10761

WARNING

- **Electrolyte is poisonous and dangerous since it contains sulfuric acid, which causes severe**

burns. Avoid any contact with skin, eyes or clothing and always shield your eyes when working near batteries. In case of contact, administer the following **FIRST AID**.

- **EXTERNAL:** Flush with plenty of water.
- **INTERNAL:** Drink large quantities of water or milk and immediately call a physician.
- **EYES:** Flush with water for 15 minutes and seek prompt medical attention.
- **Batteries produce explosive hydrogen gas. Therefore, keep sparks, flames, cigarettes, etc., away from the battery and provide sufficient ventilation when charging it in an enclosed space.**
- **KEEP THIS AND ALL BATTERIES OUT OF THE REACH OF CHILDREN.**

To charge the battery

Have a Yamaha dealer charge the battery as soon as possible if it seems to have discharged. Keep in mind that the

Periodic maintenance and adjustment

battery tends to discharge more quickly if the vehicle is equipped with optional electrical accessories.

ECA16522

NOTICE

To charge a VRLA (Valve Regulated Lead Acid) battery, a special (constant-voltage) battery charger is required. Using a conventional battery charger will damage the battery.

To store the battery

1. If the vehicle will not be used for more than one month, remove the battery, fully charge it, and then place it in a cool, dry place.
NOTICE: When removing the battery, be sure to turn the main switch off, then disconnect the negative lead before disconnecting the positive lead. [ECA16304]
2. If the battery will be stored for more than two months, check it at least once a month and fully charge it if necessary.
3. Fully charge the battery before installation. **NOTICE: When installing the battery, be sure to turn the main switch off, then con-**

nect the positive lead before connecting the negative lead.

[ECA16842]

4. After installation, make sure that the battery leads are properly connected to the battery terminals.

ECA16531

NOTICE

Always keep the battery charged. Storing a discharged battery can cause permanent battery damage.

EAU84650

Replacing the fuses

The fuse boxes and individual fuses are located under the rider seat (see page 3-28) and behind panel A (see page 6-9).

To access fuse box 1, the main fuse, and the ABS motor fuse, remove the rider seat. (See page 3-28.)

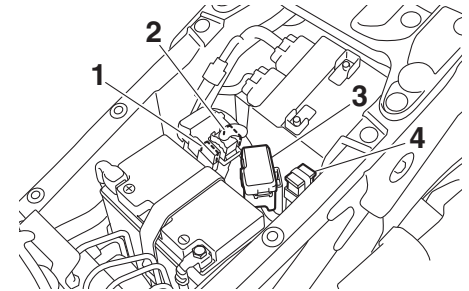

1. ABS motor spare fuse
2. ABS motor fuse
3. Fuse box 1
4. Main fuse

Periodic maintenance and adjustment

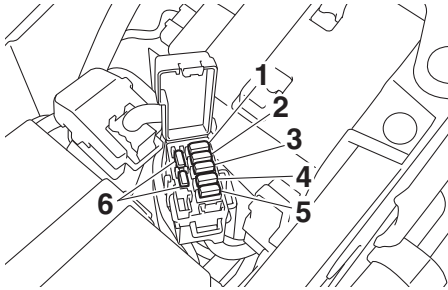

1. Fuel injection system fuse
2. ABS solenoid fuse
3. Electronic throttle valve fuse
4. Backup fuse (for clock and immobilizer system)
5. Heater fuse
6. Spare fuse

TIP

To access the ABS motor fuse, remove the starter relay cover by pulling it upward.

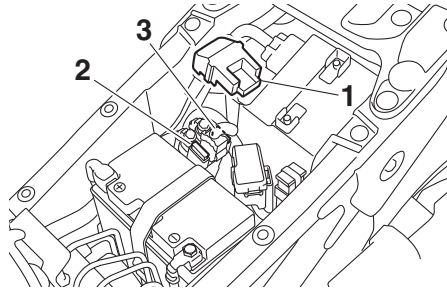

1. Starter relay cover
2. ABS motor spare fuse
3. ABS motor fuse

To access fuse box 2, fuse box 3, the brake light fuse, and the cruise control fuse, remove panel A. (See page 6-9.)

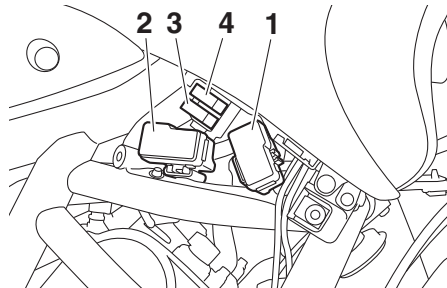

1. Fuse box 2
2. Fuse box 3
3. Cruise control fuse
4. Brake light fuse

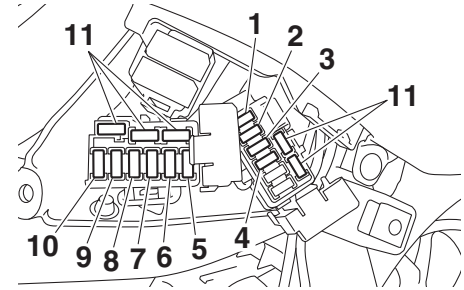

1. Signaling system fuse
2. ABS control unit fuse
3. Accessory fuse
4. Ignition fuse
5. Hazard fuse
6. Terminal fuse 1 (for auxiliary DC jack)
7. Terminal fuse 2 (for auxiliary DC jack)
8. Headlight fuse
9. Right radiator fan motor fuse
10. Left radiator fan motor fuse
11. Spare fuse

If a fuse is blown, replace it as follows.

1. Turn the main switch off and turn off the electrical circuit in question.
2. Remove the blown fuse, and then install a new fuse of the specified amperage. **WARNING! Do not use a fuse of a higher amperage rating than recommended to**

Periodic maintenance and adjustment

avoid causing extensive damage to the electrical system and possibly a fire. [EWA15132]

Specified fuses:

Main fuse:
50.0 A
ABS motor fuse:
30.0 A
Cruise control fuse:
1.0 A
Brake light fuse:
1.0 A

Specified fuses (fuse box 1):

Fuel injection system fuse:
25.0 A
ABS solenoid fuse:
20.0 A
Electronic throttle valve fuse:
7.5 A
Backup fuse:
7.5 A
Heater fuse:
10.0 A

Specified fuses (fuse box 2):

Signaling system fuse:
7.5 A
ABS control unit fuse:
5.0 A
Accessory fuse:
5.0 A
Ignition fuse:
15.0 A

Specified fuses (fuse box 3):

Hazard fuse:
7.5 A
Terminal fuse 1:
2.0 A
Terminal fuse 2:
2.0 A
Radiator fan motor fuse:
10.0 A × 2
Headlight fuse:
10.0 A

3. Turn the main switch on and turn on the electrical circuit in question to check if the device operates.
4. If the fuse immediately blows again, have a Yamaha dealer check the electrical system.

Vehicle lights

EAU72980

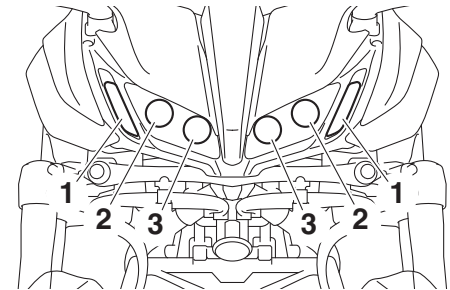

1. Auxiliary light
2. Headlight (low beam)
3. Headlight (high beam)

This model is equipped with full-LED lighting. There are no user replaceable bulbs.

If a light does not come on, check the fuses and then have a Yamaha dealer check the vehicle.

ECA16581

NOTICE

Do not affix any type of tinted film or stickers to the headlight lens.

EAU25872

Troubleshooting

Although Yamaha motorcycles receive a thorough inspection before shipment from the factory, trouble may occur during operation. Any problem in the fuel, compression, or ignition systems, for example, can cause poor starting and loss of power.

The following troubleshooting charts represent quick and easy procedures for checking these vital systems yourself. However, should your motorcycle require any repair, take it to a Yamaha dealer, whose skilled technicians have the necessary tools, experience, and know-how to service the motorcycle properly.

Use only genuine Yamaha replacement parts. Imitation parts may look like Yamaha parts, but they are often inferior, have a shorter service life and can lead to expensive repair bills.

EWA15142



WARNING

When checking the fuel system, do not smoke, and make sure there are no open flames or sparks in the area, including pilot lights from water

heaters or furnaces. Gasoline or gasoline vapors can ignite or explode, causing severe injury or property damage.

Periodic maintenance and adjustment

EAU42505

Troubleshooting charts

Starting problems or poor engine performance

1. Fuel

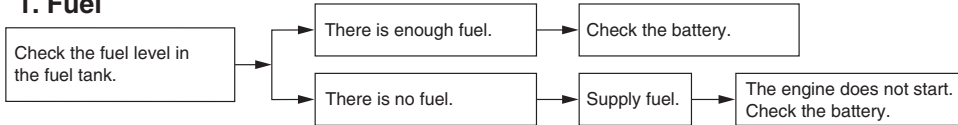

2. Battery

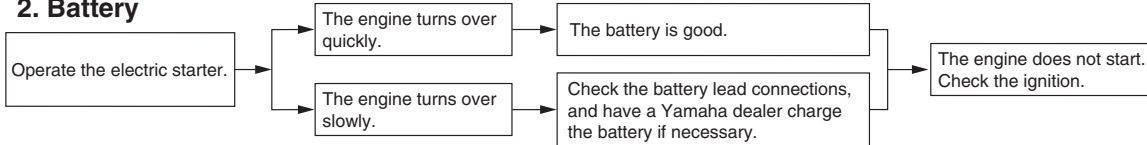

3. Ignition

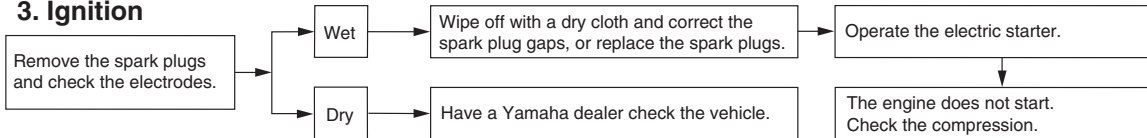

4. Compression

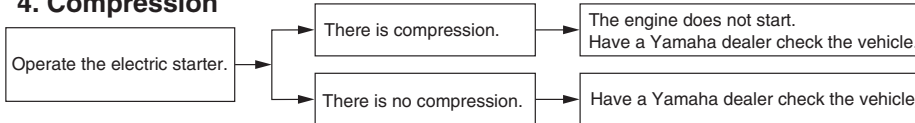

Periodic maintenance and adjustment

Engine overheating

EWAT1041

WARNING

- Do not remove the radiator cap when the engine and radiator are hot. Scalding hot fluid and steam may be blown out under pressure, which could cause serious injury. Be sure to wait until the engine has cooled.
- Place a thick rag, like a towel, over the radiator cap, and then slowly rotate the cap counterclockwise to the detent to allow any residual pressure to escape. When the hissing sound has stopped, press down on the cap while turning it counterclockwise, and then remove the cap.

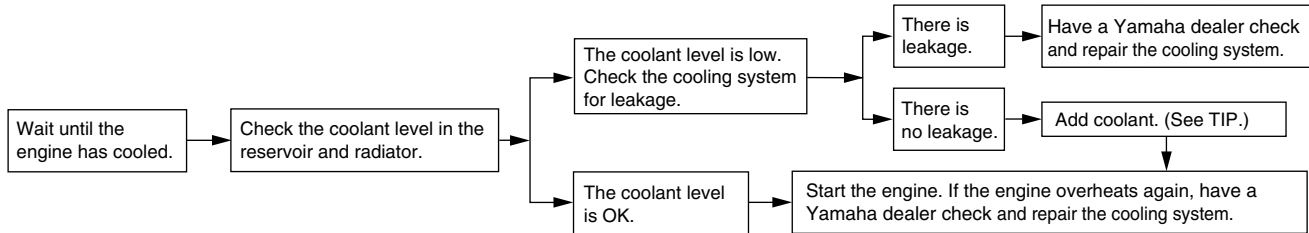

TIP

If coolant is not available, tap water can be temporarily used instead, provided that it is changed to the recommended coolant as soon as possible.

Motorcycle care and storage

Matte color caution

EAU37834

ECA15193

NOTICE

Some models are equipped with matte colored finished parts. Be sure to consult a Yamaha dealer for advice on what products to use before cleaning the vehicle. Using a brush, harsh chemical products or cleaning compounds when cleaning these parts will scratch or damage their surface. Wax also should not be applied to any matte colored finished parts.

7

Care

EAU83443

Frequent, thorough cleaning of the vehicle will not only enhance its appearance but also will improve its general performance and extend the useful life of many components. Washing, cleaning, and polishing will also give you a chance to inspect the condition of the vehicle more frequently. Be sure to wash the vehicle after riding in the rain or near the sea, because salt is corrosive to metals.

TIP

- The roads of heavy snowfall areas may be sprayed with salt as a de-icing method. This salt can stay on the roads well into spring, so be sure to wash the underside and chassis parts after riding in such areas.
 - Genuine Yamaha care and maintenance products are sold under the YAMALUBE brand in many markets worldwide.
 - See your Yamaha dealer for additional cleaning tips.
-

ECA26280

NOTICE

Improper cleaning can cause cosmetic and mechanical damage. Do not use:

- high-pressure washers or steam-jet cleaners. Excessive water pressure may cause water seepage and deterioration of wheel bearings, brakes, transmission seals and electrical devices. Avoid high-pressure detergent applications such as those available in coin-operated car washers.
- harsh chemicals, including strong acidic wheel cleaners, especially on spoke or magnesium wheels.
- harsh chemicals, abrasive cleaning compounds, or wax on matte-finished parts. Brushes can scratch and damage the matte-finish, use soft sponge or towel only.
- towels, sponges, or brushes contaminated with abrasive cleaning products or strong

chemicals such as, solvents, gasoline, rust removers, brake fluid, or antifreeze, etc.

Before washing

1. Park the vehicle out of direct sunlight and allow it to cool. This will help avoid water spots.
2. Make sure all caps, covers, electrical couplers and connectors are tightly installed.
3. Cover the muffler end with a plastic bag and a strong rubber band.
4. Pre-soak stubborn stains like insects or bird droppings with a wet towel for a few minutes.
5. Remove road grime and oil stains with a quality degreasing agent and a plastic-bristle brush or sponge. **NOTICE: Do not use degreasing agent on areas requiring lubrication such as seals, gaskets, and wheel axles. Follow product instructions.**

[ECA26290]

Washing

1. Rinse off any degreaser and spray down the vehicle with a garden hose. Use only enough pressure to do the job. Avoid spraying water directly into the muffler, instrument panel, air inlet, or other inner areas such as underseat storage compartments.
2. Wash the vehicle with a quality automotive-type detergent mixed with cool water and a soft, clean towel or sponge. Use an old toothbrush or plastic-bristle brush for hard-to-reach places. **NOTICE: Use cold water if the vehicle has been exposed to salt. Warm water will increase salt's corrosive properties.** [ECA26301]
3. For windshield-equipped vehicles: Clean the windshield with a soft towel or sponge dampened with water and a pH neutral detergent. If necessary, use a high-quality windshield cleaner or polish for motorcycles. **NOTICE: Never use any strong chemicals to clean the windshield. Additionally, some cleaning compounds for**

plastic may scratch the windshield, so be sure to test all cleaning products before general application.

4. Rinse off thoroughly with clean water. Be sure to remove all detergent residues, as they can be harmful to plastic parts.

After washing

1. Dry the vehicle with a chamois or absorbent towel, preferably microfiber terrycloth.
2. For drive chain-equipped models: Dry and then lubricate the drive chain to prevent rust.
3. Use a chrome polish to shine chrome, aluminum, and stainless steel parts. Often the thermally induced discoloring of stainless steel exhaust systems can be removed through polishing.
4. Apply a corrosion protection spray on all metal parts including chrome or nickel-plated surfaces. **WARNING! Do not apply silicone or oil spray to seats, hand grips, rubber foot pegs or tire treads. Otherwise these parts**

Motorcycle care and storage

EAU83472

will become slippery, which could cause loss of control. **Thoroughly clean the surfaces of these parts before operating the vehicle.** [EWA20650]

5. Treat rubber, vinyl, and unpainted plastic parts with a suitable care product.
6. Touch up minor paint damage caused by stones, etc.
7. Wax all painted surfaces using a non-abrasive wax or use a detail spray for motorcycles.
8. When finished cleaning, start the engine and let it idle for several minutes to help dry any remaining moisture.
9. If the headlight lens has fogged up, start the engine and turn on the headlight to help remove the moisture.
10. Let the vehicle dry completely before storing or covering it.

ECA26320

NOTICE

- **Do not apply wax to rubber or unpainted plastic parts.**

- **Do not use abrasive polishing compounds as they will wear away the paint.**
- **Apply sprays and wax sparingly. Wipe off excess afterwards.**

EWA20660



Contaminants left on the brakes or tires can cause loss of control.

- **Make sure there is no lubricant or wax on the brakes or tires.**
- **If necessary, wash the tires with warm water and a mild detergent.**
- **If necessary, clean the brake discs and pads with brake cleaner or acetone.**
- **Before riding at higher speeds, test the vehicle's braking performance and cornering behavior.**

Storage

Always store the vehicle in a cool, dry place. If necessary, protect it against dust with a porous cover. Be sure the engine and the exhaust system are cool before covering the vehicle. If the vehicle often sits for weeks at a time between uses, the use of a quality fuel stabilizer is recommended after each fill-up.

ECA21170

NOTICE

- **Storing the vehicle in a poorly ventilated room or covering it with a tarp, while it is still wet, will allow water and humidity to seep in and cause rust.**
- **To prevent corrosion, avoid damp cellars, stables (because of the presence of ammonia) and areas where strong chemicals are stored.**

Long term storage

Before storing the vehicle long term (60 days or more):

Motorcycle care and storage

1. Make all necessary repairs and perform any outstanding maintenance.
2. Follow all instructions in the Care section of this chapter.
3. Fill up the fuel tank, adding fuel stabilizer according to product instructions. Run the engine for 5 minutes to distribute treated fuel through the fuel system.
4. For vehicles equipped with a fuel cock: Turn the fuel cock lever to the off position.
5. For vehicles with a carburetor: To prevent fuel deposits from building up, drain the fuel in the carburetor float chamber into a clean container. Retighten the drain bolt and pour the fuel back into the fuel tank.
6. Use a quality engine fogging oil according to product instructions to protect internal engine components from corrosion. If engine fogging oil is not available, perform the following steps for each cylinder:
 - a. Remove the spark plug cap and spark plug.
 - b. Pour a teaspoonful of engine oil into the spark plug bore.
 - c. Install the spark plug cap onto the spark plug, and then place the spark plug on the cylinder head so that the electrodes are grounded. (This will limit sparking during the next step.)
 - d. Turn the engine over several times with the starter. (This will coat the cylinder wall with oil.)
WARNING! To prevent damage or injury from sparking, make sure to ground the spark plug electrodes while turning the engine over.
[EWA10952]
 - e. Remove the spark plug cap from the spark plug, and then install the spark plug and the spark plug cap.
7. Lubricate all control cables, pivots, levers and pedals, as well as the sidestand and centerstand (if equipped).
8. Check and correct the tire air pressure, and then lift the vehicle so that all wheels are off the ground. Otherwise, turn the wheels a little once a month in order to prevent the tires from becoming degraded in one spot.
9. Cover the muffler outlet with a plastic bag to prevent moisture from entering it.
10. Remove the battery and fully charge it, or attach a maintenance charger to keep the battery optimally charged. **NOTICE: Confirm that the battery and its charger are compatible. Do not charge a VRLA battery with a conventional charger.** [ECA26330]

TIP

- If the battery will be removed, charge it once a month and store it in a temperate location between 0-30 °C (32-90 °F).
- See page 6-30 for more information on charging and storing the battery.

Specifications

Dimensions:

Overall length:
2150 mm (84.6 in)
Overall width:
885 mm (34.8 in)
Overall height:
1425 mm (56.1 in)
Seat height:
835 mm (32.9 in)
Wheelbase:
1510 mm (59.4 in)
Ground clearance:
150 mm (5.91 in)
Minimum turning radius:
2.8 m (9.19 ft)

Weight:

Curb weight:
267 kg (589 lb)

Engine:

Combustion cycle:
4-stroke
Cooling system:
Liquid cooled
Valve train:
DOHC
Cylinder arrangement:
Inline
Number of cylinders:
3-cylinder
Displacement:
847 cm³
Bore × stroke:
78.0 × 59.1 mm (3.07 × 2.33 in)

Starting system:
Electric starter

Engine oil:

Recommended brand:



SAE viscosity grades:
10W-40
Recommended engine oil grade:
API service SG type or higher, JASO
standard MA
Engine oil quantity:
Oil change:
2.40 L (2.54 US qt, 2.11 Imp.qt)
With oil filter removal:
2.70 L (2.85 US qt, 2.38 Imp.qt)

Coolant quantity:

Coolant reservoir (up to the maximum level
mark):
0.25 L (0.26 US qt, 0.22 Imp.qt)
Radiator (including all routes):
1.93 L (2.04 US qt, 1.70 Imp.qt)

Fuel:

Recommended fuel:
Premium unleaded gasoline (Gasohol [E10]
acceptable)
Fuel tank capacity:
18 L (4.8 US gal, 4.0 Imp.gal)
Fuel reserve amount:
4.0 L (1.06 US gal, 0.88 Imp.gal)

Fuel injection:

Throttle body:
ID mark:
BD51 00

Drivetrain:

Gear ratio:
1st:
2.667 (40/15)
2nd:
2.000 (38/19)
3rd:
1.619 (34/21)
4th:
1.381 (29/21)
5th:
1.190 (25/21)
6th:
1.037 (28/27)

Chassis:

Track:
410 mm (16.1 in)

Front tire:

Type:
Tubeless
Size:
120/70 R 15 M/C 56V

Manufacturer/model:
BRIDGESTONE/A41F M

Rear tire:

Type:
Tubeless
Size:
190/55 R 17 M/C 75V

Manufacturer/model:
BRIDGESTONE/A41R M

Loading:

Maximum load:
191 kg (421 lb)
(Total weight of rider, passenger, cargo
and accessories)

Front brake:

Type:
Hydraulic disc brake

Rear brake:

Type:
Hydraulic single disc brake

Front suspension:

Type:
Telescopic fork

Rear suspension:

Type:
Swingarm (link suspension)

Electrical system:

System voltage:
12 V

Battery:

Model:
YTZ10S
Voltage, capacity:
12 V, 8.6 Ah (10 HR)

Bulb wattage:

Headlight:
LED
Brake/tail light:
LED
Front turn signal light:
LED

Rear turn signal light:
LED
Auxiliary light:
LED
License plate light:
LED

Consumer information

EAU53562

Identification numbers

Record the vehicle identification number, engine serial number, and the model label information in the spaces provided below. These identification numbers are needed when registering the vehicle with the authorities in your area and when ordering spare parts from a Yamaha dealer.

VEHICLE IDENTIFICATION NUMBER:

ENGINE SERIAL NUMBER:

MODEL LABEL INFORMATION:

9

EAU26411

Vehicle identification number

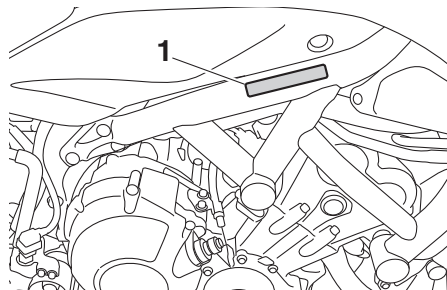

1. Vehicle identification number

The vehicle identification number is stamped into the frame.

TIP

The vehicle identification number is used to identify your vehicle and may be used to register it with the licensing authority in your area.

EAU26442

Engine serial number

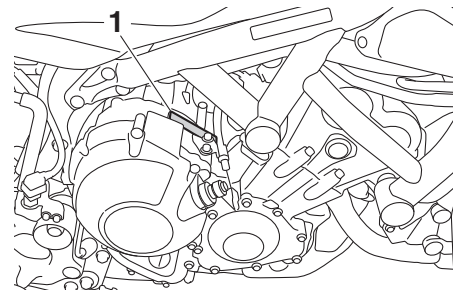

1. Engine serial number

The engine serial number is stamped into the crankcase.

EAU26461

Model label

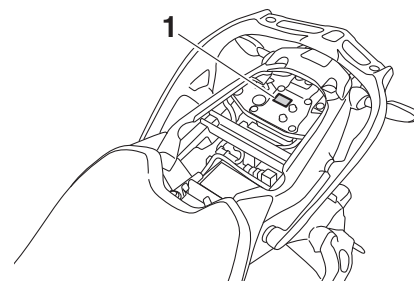

1. Model label

The model label is affixed to the location shown. Record the information on this label in the space provided. This information will be needed when ordering spare parts from a Yamaha dealer.

Diagnostic connector

EAU69910

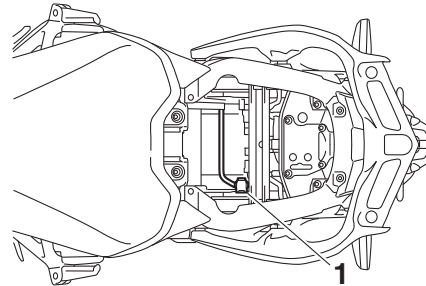

1. Diagnostic connector

The diagnostic connector is located as shown.

Vehicle data recording

EAU85300

This model's ECU stores certain vehicle data to assist in the diagnosis of malfunctions and for research, statistical analysis and development purposes.

Although the sensors and recorded data will vary by model, the main data points are:

- Vehicle status and engine performance data
- Fuel-injection and emission-related data

This data will be uploaded only when a special Yamaha diagnostic tool is attached to the vehicle, such as when maintenance checks or service procedures are performed.

Vehicle data uploaded will be handled appropriately according to the following Privacy Policy.

Privacy Policy

<https://www.yamaha-motor.eu/eu/privacy/privacy-policy.aspx>

Consumer information

Yamaha will not disclose this data to a third party except in the following cases. In addition, Yamaha may provide vehicle data to a contractor in order to outsource services related to the handling of vehicle data. Even in this case, Yamaha will require the contractor to properly handle the vehicle data we provided and Yamaha will appropriately manage the data.

- With the consent of the vehicle owner
- Where obligated by law
- For use by Yamaha in litigation
- When the data is not related to an individual vehicle nor owner

- A**
- ABS..... 3-21
 - ABS warning light..... 3-6
 - Air filter element..... 6-15
 - Auxiliary DC jacks..... 3-34
- B**
- Battery..... 6-30
 - Brake and clutch levers, checking and lubricating..... 6-27
 - Brake and shift pedals, checking and lubricating..... 6-26
 - Brake fluid, changing..... 6-23
 - Brake fluid level, checking..... 6-22
 - Brake lever..... 3-21
 - Brake lever free play, checking..... 6-20
 - Brake light switches..... 6-20
 - Brake pedal..... 3-21
- C**
- Cables, checking and lubricating..... 6-25
 - Canister..... 6-11
 - Care..... 7-1
 - Catalytic converter..... 3-27
 - Centerstand and sidestand, checking and lubricating..... 6-27
 - Clutch lever..... 3-19
 - Clutch lever free play, adjusting..... 6-19
 - Coolant..... 6-14
 - Coolant temperature warning light..... 3-6
 - Cruise control indicator lights..... 3-6
 - Cruise control switches..... 3-4
 - Cruise control system..... 3-8
- D**
- Data recording, vehicle..... 9-2
 - Diagnostic connector..... 9-2
 - Dimmer/Pass switch..... 3-4
 - D-mode (drive mode)..... 3-19
 - Drive chain, cleaning and lubricating... 6-25
 - Drive chain slack..... 6-23
 - Drive mode switch..... 3-5
- E**
- Engine break-in..... 5-4
 - Engine idling speed, checking..... 6-15
 - Engine oil..... 6-11
 - Engine serial number..... 9-1
 - Engine trouble warning light..... 3-6
- F**
- Front and rear brake pads, checking... 6-21
 - Front fork, adjusting..... 3-31
 - Front fork, checking..... 6-28
 - Fuel..... 3-25
 - Fuel consumption, tips for reducing..... 5-4
 - Fuel tank cap..... 3-24
 - Fuel tank overflow hose..... 3-27
 - Fuses, replacing..... 6-31
- H**
- Handlebar switches..... 3-3
 - Hazard switch..... 3-4
 - Helmet holding cable..... 3-29
 - High beam indicator light..... 3-5
 - Horn switch..... 3-4
- I**
- Identification numbers..... 9-1
 - Ignition circuit cut-off system..... 3-35
 - Immobilizer system..... 3-1
 - Immobilizer system indicator light..... 3-7
 - Indicator lights and warning lights..... 3-5
- M**
- Main switch/steering lock..... 3-2
 - Maintenance and lubrication, periodic ... 6-5
 - Maintenance, emission control system..... 6-3
 - Matte color, caution..... 7-1
 - MENU switch..... 3-4
 - Model label..... 9-1
 - Multi-function meter unit..... 3-11
- N**
- Neutral indicator light..... 3-5
- O**
- Oil level warning light..... 3-5
- P**
- Panel, removing and installing..... 6-9
 - Parking..... 5-5
 - Part locations..... 2-1
- Q**
- Quick shift system..... 3-20
- R**
- Rear view mirrors..... 3-31
- S**
- Safety information..... 1-1
 - Seats..... 3-28
 - SELECT switch..... 3-5
 - Shift indicator light..... 3-7
 - Shifting..... 5-2
 - Shift pedal..... 3-20
 - Shock absorber assembly, adjusting ... 3-32
 - Sidestand..... 3-35
 - Spark plugs, checking..... 6-10
 - Specifications..... 8-1
 - Starting the engine..... 5-1
 - Steering bearings, lubricating..... 6-29
 - Steering, checking..... 6-29
 - Stop/Run/Start switch..... 3-4

Index

Storage	7-3
Storage compartment.....	3-30
Swingarm pivots, lubricating	6-28

T

Throttle grip and cable, checking and lubricating.....	6-26
Throttle grip free play, checking	6-16
Tires	6-16
Tool kit	6-2
Traction control system	3-22
Traction control system indicator light ...	3-7
Troubleshooting.....	6-34
Troubleshooting charts.....	6-35
Turn signal indicator lights.....	3-5
Turn signal switch.....	3-4

V

Valve clearance.....	6-16
Vehicle identification number	9-1
Vehicle lights.....	6-33

W

Wheel bearings, checking.....	6-30
Wheels	6-19

Y

Yamalube.....	6-13
---------------	------

