



⚠ Read this manual carefully before operating this vehicle.

OWNER'S MANUAL

TENERE
700

XTZ690
XTZ690-U

BW3-F8199-E0

 **Read this manual carefully before operating this vehicle. This manual should stay with this vehicle if it is sold.**

Declaration of Conformity:

Hereby, YAMAHA MOTOR ELECTRONICS Co., Ltd declares that the radio equipment type, IMMOBILIZER, BW3-00 is in compliance with Directive 2014/53/EU.

The full text of the EU declaration of conformity is available at the following internet address:

https://global.yamaha-motor.com/eu_doc/

Frequency band: 134.2 kHz

The maximum radio frequency power: 49.0 [dB μ V/m]

Manufacturer:

YAMAHA MOTOR ELECTRONICS Co., Ltd

1450-6 Mori, Mori-machi, Shuchi-Gun, Shizuoka, 437-0292 Japan

Importer:

YAMAHA MOTOR EUROPE N.V.

Koolhovenlaan 101, 1119 NC Schiphol-Rijk, 1117 ZN, Schiphol, the Netherlands

Welcome to the Yamaha world of motorcycling!

As the owner of the XTZ690/XTZ690-U, you are benefiting from Yamaha's vast experience and newest technology regarding the design and manufacture of high-quality products, which have earned Yamaha a reputation for dependability.

Please take the time to read this manual thoroughly, so as to enjoy all advantages of your XTZ690/XTZ690-U. The Owner's Manual does not only instruct you in how to operate, inspect and maintain your motorcycle, but also in how to safeguard yourself and others from trouble and injury.

In addition, the many tips given in this manual will help keep your motorcycle in the best possible condition. If you have any further questions, do not hesitate to contact your Yamaha dealer.

The Yamaha team wishes you many safe and pleasant rides. So, remember to put safety first!

Yamaha continually seeks advancements in product design and quality. Therefore, while this manual contains the most current product information available at the time of printing, there may be minor discrepancies between your motorcycle and this manual. If there is any question concerning this manual, please consult a Yamaha dealer.





Please read this manual carefully and completely before operating this motorcycle.

Important manual information

EAU10134

Particularly important information is distinguished in this manual by the following notations:

	This is the safety alert symbol. It is used to alert you to potential personal injury hazards. Obey all safety messages that follow this symbol to avoid possible injury or death.
 WARNING	A WARNING indicates a hazardous situation which, if not avoided, could result in death or serious injury.
NOTICE	A NOTICE indicates special precautions that must be taken to avoid damage to the vehicle or other property.
TIP	A TIP provides key information to make procedures easier or clearer.

*Product and specifications are subject to change without notice.

EAUM1013

**XTZ690/XTZ690-U
OWNER'S MANUAL
©2019 by MBK INDUSTRIE
1st edition, July 2019
All rights reserved
Any reprinting or unauthorized use
without the written permission of
MBK INDUSTRIE
is expressly prohibited.
Printed in France.**

Table of contents

Safety information	1-1	DC power outlets	3-26	Replacing the air filter element and cleaning the check hose	6-15
Description	2-1	Sidestand	3-27	Checking the throttle grip free play.....	6-17
Left view	2-1	Ignition circuit cut-off system	3-28	Valve clearance.....	6-17
Right view.....	2-2	For your safety – pre-operation checks	4-1	Tires	6-17
Controls and instruments	2-3	Operation and important riding points	5-1	Spoke wheels	6-19
Instrument and control functions ...	3-1	Engine break-in	5-1	Adjusting the clutch lever free play.....	6-19
Immobilizer system.....	3-1	Starting the engine.....	5-2	Checking the brake lever free play.....	6-20
Main switch/steering lock.....	3-2	Shifting	5-3	Brake light switches	6-21
Indicator lights and warning lights.....	3-3	Tips for reducing fuel consumption.....	5-4	Checking the front and rear brake pads	6-21
Multi-function meter unit	3-5	Parking	5-4	Checking the brake fluid level	6-22
Handlebar switches.....	3-12	Periodic maintenance and adjustment	6-1	Changing the brake fluid	6-23
Clutch lever	3-14	Tool kit	6-2	Drive chain slack.....	6-23
Shift pedal	3-14	Periodic maintenance charts	6-3	Cleaning and lubricating the drive chain.....	6-25
Brake lever.....	3-15	Periodic maintenance chart for the emission control system.....	6-3	Checking and lubricating the cables.....	6-26
Brake pedal	3-15	General maintenance and lubrication chart.....	6-5	Checking and lubricating the throttle grip and cable	6-26
ABS	3-15	Removing and installing cowlings...	6-9	Checking and lubricating the brake and shift pedals.....	6-26
Fuel tank cap.....	3-16	Checking the spark plugs	6-9	Checking and lubricating the brake and clutch levers.....	6-27
Fuel.....	3-17	Canister.....	6-10	Checking and lubricating the sidestand.....	6-28
Fuel tank overflow hose	3-19	Engine oil and oil filter cartridge....	6-11	Lubricating the rear suspension ...	6-28
Catalytic converter	3-19	Why Yamalube	6-14		
Seats	3-19	Coolant.....	6-14		
Adjusting the headlight beams.....	3-21				
Adjusting the front fork.....	3-21				
Front fork bleeding	3-23				
Adjusting the shock absorber assembly.....	3-23				
Luggage strap holders	3-25				
Front fender	3-26				

Table of contents

Lubricating the swingarm	
pivots	6-28
Checking the front fork.....	6-29
Checking the steering	6-29
Checking the wheel bearings	6-30
Battery	6-30
Replacing the fuses.....	6-31
Vehicle lights	6-33
Tail/brake light.....	6-33
Replacing a turn signal light	
bulb	6-33
License plate light	6-34
Supporting the motorcycle.....	6-34
Troubleshooting	6-35
Troubleshooting chart	6-36
Motorcycle care and storage	7-1
Matte color caution	7-1
Care.....	7-1
Storage.....	7-3
Specifications.....	8-1
Consumer information	9-1
Identification numbers.....	9-1
Diagnostic connector	9-2
Vehicle data recording	9-2
Index	10-1

Be a Responsible Owner

As the vehicle's owner, you are responsible for the safe and proper operation of your motorcycle.

Motorcycles are single-track vehicles. Their safe use and operation are dependent upon the use of proper riding techniques as well as the expertise of the operator. Every operator should know the following requirements before riding this motorcycle.

He or she should:

- Obtain thorough instructions from a competent source on all aspects of motorcycle operation.
- Observe the warnings and maintenance requirements in this Owner's Manual.
- Obtain qualified training in safe and proper riding techniques.
- Obtain professional technical service as indicated in this Owner's Manual and/or when made necessary by mechanical conditions.

- Never operate a motorcycle without proper training or instruction. Take a training course. Beginners should receive training from a certified instructor. Contact an authorized motorcycle dealer to find out about the training courses nearest you.

Safe Riding

Perform the pre-operation checks each time you use the vehicle to make sure it is in safe operating condition. Failure to inspect or maintain the vehicle properly increases the possibility of an accident or equipment damage. See page 4-1 for a list of pre-operation checks.

- This motorcycle is designed to carry the operator and a passenger.
- The failure of motorists to detect and recognize motorcycles in traffic is the predominating cause of automobile/motorcycle accidents. Many accidents have been caused by an automobile driver who did not see the motorcycle. Making yourself conspicuous ap-

pears to be very effective in reducing the chance of this type of accident.

Therefore:

- Wear a brightly colored jacket.
- Use extra caution when you are approaching and passing through intersections, since intersections are the most likely places for motorcycle accidents to occur.
- Ride where other motorists can see you. Avoid riding in another motorist's blind spot.
- Never maintain a motorcycle without proper knowledge. Contact an authorized motorcycle dealer to inform you on basic motorcycle maintenance. Certain maintenance can only be carried out by certified staff.

- Many accidents involve inexperienced operators. In fact, many operators who have been involved in accidents do not even have a current motorcycle license.
 - Make sure that you are qualified and that you only lend your motorcycle to other qualified operators.
 - Know your skills and limits. Staying within your limits may help you to avoid an accident.
 - We recommend that you practice riding your motorcycle where there is no traffic until you have become thoroughly familiar with the motorcycle and all of its controls.
 - Many accidents have been caused by error of the motorcycle operator. A typical error made by the operator is veering wide on a turn due to excessive speed or undercornering (insufficient lean angle for the speed).
 - Always obey the speed limit and never travel faster than warranted by road and traffic conditions.
 - Always signal before turning or changing lanes. Make sure that other motorists can see you.
 - The posture of the operator and passenger is important for proper control.
 - The operator should keep both hands on the handlebar and both feet on the operator footrests during operation to maintain control of the motorcycle.
 - The passenger should always hold onto the operator, the seat strap or grab bar, if equipped, with both hands and keep both feet on the passenger footrests. Never carry a passenger unless he or she can firmly place both feet on the passenger footrests.
 - Never ride under the influence of alcohol or other drugs.
- Protective Apparel**
- The majority of fatalities from motorcycle accidents are the result of head injuries. The use of a safety helmet is the single most critical factor in the prevention or reduction of head injuries.
- Always wear an approved helmet.
- Avoid Carbon Monoxide Poisoning**
- All engine exhaust contains carbon monoxide, a deadly gas. Breathing carbon monoxide can cause headaches, dizziness, drowsiness, nausea, confusion, and eventually death.
- Wear a face shield or goggles. Wind in your unprotected eyes could contribute to an impairment of vision that could delay seeing a hazard.
 - The use of a jacket, heavy boots, trousers, gloves, etc., is effective in preventing or reducing abrasions or lacerations.
 - Never wear loose-fitting clothes, otherwise they could catch on the control levers, footrests, or wheels and cause injury or an accident.
 - Always wear protective clothing that covers your legs, ankles, and feet. The engine or exhaust system become very hot during or after operation and can cause burns.
 - A passenger should also observe the above precautions.

Safety information

1

Carbon Monoxide is a colorless, odorless, tasteless gas which may be present even if you do not see or smell any engine exhaust. Deadly levels of carbon monoxide can collect rapidly and you can quickly be overcome and unable to save yourself. Also, deadly levels of carbon monoxide can linger for hours or days in enclosed or poorly ventilated areas. If you experience any symptoms of carbon monoxide poisoning, leave the area immediately, get fresh air, and **SEEK MEDICAL TREATMENT**.

- Do not run engine indoors. Even if you try to ventilate engine exhaust with fans or open windows and doors, carbon monoxide can rapidly reach dangerous levels.
- Do not run engine in poorly ventilated or partially enclosed areas such as barns, garages, or carports.
- Do not run engine outdoors where engine exhaust can be drawn into a building through openings such as windows and doors.

Loading

Adding accessories or cargo to your motorcycle can adversely affect stability and handling if the weight distribution of the motorcycle is changed. To avoid the possibility of an accident, use extreme caution when adding cargo or accessories to your motorcycle. Use extra care when riding a motorcycle that has added cargo or accessories. Here, along with the information about accessories below, are some general guidelines to follow if loading cargo to your motorcycle:

The total weight of the operator, passenger, accessories and cargo must not exceed the maximum load limit.

Operation of an overloaded vehicle could cause an accident.

Maximum load:
190 kg (419 lb)

When loading within this weight limit, keep the following in mind:

- Cargo and accessory weight should be kept as low and close to the motorcycle as possible. Securely pack your heaviest items as

close to the center of the vehicle as possible and make sure to distribute the weight as evenly as possible on both sides of the motorcycle to minimize imbalance or instability.

- Shifting weights can create a sudden imbalance. Make sure that accessories and cargo are securely attached to the motorcycle before riding. Check accessory mounts and cargo restraints frequently.
- Properly adjust the suspension for your load (suspension-adjustable models only), and check the condition and pressure of your tires.
- Never attach any large or heavy items to the handlebar, front fork, or front fender. These items, including such cargo as sleeping bags, duffel bags, or tents, can create unstable handling or a slow steering response.
- **This vehicle is not designed to pull a trailer or to be attached to a sidecar.**

Genuine Yamaha Accessories

Choosing accessories for your vehicle is an important decision. Genuine Yamaha accessories, which are available only from a Yamaha dealer, have been designed, tested, and approved by Yamaha for use on your vehicle.

Many companies with no connection to Yamaha manufacture parts and accessories or offer other modifications for Yamaha vehicles. Yamaha is not in a position to test the products that these aftermarket companies produce. Therefore, Yamaha can neither endorse nor recommend the use of accessories not sold by Yamaha or modifications not specifically recommended by Yamaha, even if sold and installed by a Yamaha dealer.

Aftermarket Parts, Accessories, and Modifications

While you may find aftermarket products similar in design and quality to genuine Yamaha accessories, recognize that some aftermarket accessories or modifications are not suitable because of potential safety hazards to you or others. Installing aftermarket

products or having other modifications performed to your vehicle that change any of the vehicle's design or operation characteristics can put you and others at greater risk of serious injury or death. You are responsible for injuries related to changes in the vehicle.

Keep the following guidelines in mind, as well as those provided under "Loading" when mounting accessories.

- Never install accessories or carry cargo that would impair the performance of your motorcycle. Carefully inspect the accessory before using it to make sure that it does not in any way reduce ground clearance or cornering clearance, limit suspension travel, steering travel or control operation, or obscure lights or reflectors.
- Accessories fitted to the handlebar or the front fork area can create instability due to improper weight distribution or aerodynamic changes. If accessories are added to the handlebar or

front fork area, they must be as lightweight as possible and should be kept to a minimum.

- Bulky or large accessories may seriously affect the stability of the motorcycle due to aerodynamic effects. Wind may attempt to lift the motorcycle, or the motorcycle may become unstable in cross winds. These accessories may also cause instability when passing or being passed by large vehicles.
- Certain accessories can displace the operator from his or her normal riding position. This improper position limits the freedom of movement of the operator and may limit control ability, therefore, such accessories are not recommended.
- Use caution when adding electrical accessories. If electrical accessories exceed the capacity of the motorcycle's electrical system, an electric failure could result, which could cause a dangerous loss of lights or engine power.

Safety information

1

Aftermarket Tires and Rims

The tires and rims that came with your motorcycle were designed to match the performance capabilities and to provide the best combination of handling, braking, and comfort. Other tires, rims, sizes, and combinations may not be appropriate. Refer to page 6-17 for tire specifications and more information on replacing your tires.

Transporting the Motorcycle

Be sure to observe following instructions before transporting the motorcycle in another vehicle.

- Remove all loose items from the motorcycle.
- Check that the fuel cock (if equipped) is in the “OFF” position and that there are no fuel leaks.
- Point the front wheel straight ahead on the trailer or in the truck bed, and choke it in a rail to prevent movement.
- Shift the transmission in gear (for models with a manual transmission).
- Secure the motorcycle with tie-downs or suitable straps that are attached to solid parts of the motorcycle, such as the frame or upper front fork triple clamp (and not, for example, to rubber-mounted handlebars or turn signals, or parts that could break). Choose the location for the straps carefully so the straps will not rub against painted surfaces during transport.
- The suspension should be compressed somewhat by the tie-downs, if possible, so that the motorcycle will not bounce excessively during transport.

Left view

2

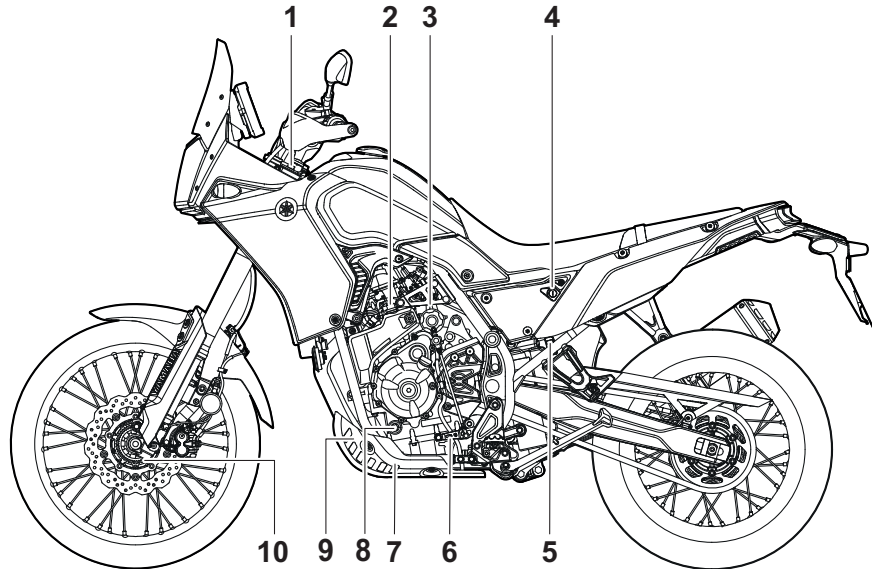

1. Rebound damping force adjusting screw (page 3-23)
2. Coolant reservoir (page 6-14)
3. Canister (page 6-10)
4. Seat lock (page 3-19)
5. Shock absorber assembly spring preload adjusting knob (page 3-23)
6. Shift pedal (page 3-14)
7. Engine oil drain bolt (page 6-11)
8. Engine oil level check window (page 6-11)
9. Engine oil filter cartridge (page 6-11)
10. Front fork compression damping force adjusting screw (page 3-21)

Description

EAU10421

Right view

2

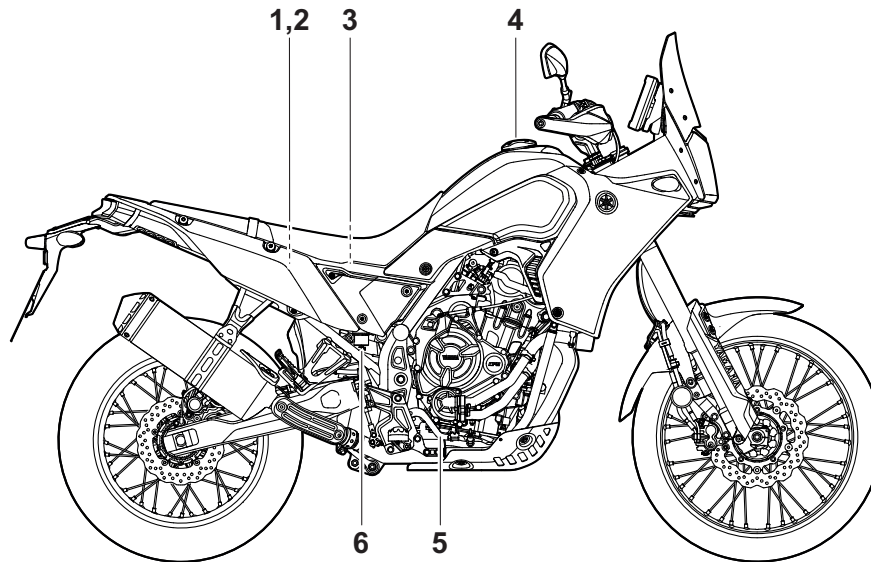

1. Main fuse (page 6-31)
2. Fuse box (page 6-31)
3. Battery (page 6-30)
4. Fuel tank cap (page 3-16)
5. Brake pedal (page 3-15)
6. Rear brake fluid reservoir (page 6-22)

Controls and instruments

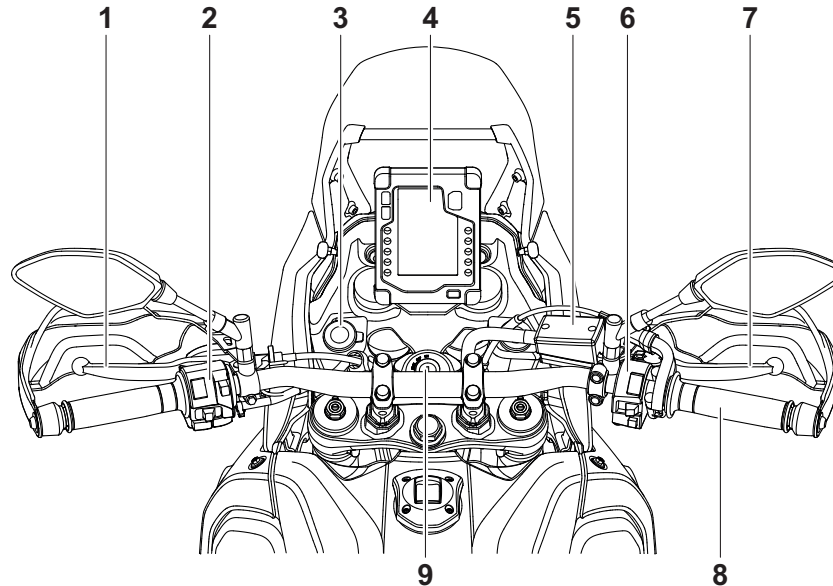

1. Clutch lever (page 3-14)

2. Left handlebar switches (page 3-12)

3. Auxiliary DC jack (page 3-26)

4. Multi-function meter unit (page 3-5)

5. Front brake fluid reservoir (page 6-22)

6. Right handlebar switches (page 3-12)

7. Brake lever (page 3-15)

8. Throttle grip (page 6-17)

9. Main switch/steering lock (page 3-2)

Instrument and control functions

3

Immobilizer system

EAU1097A

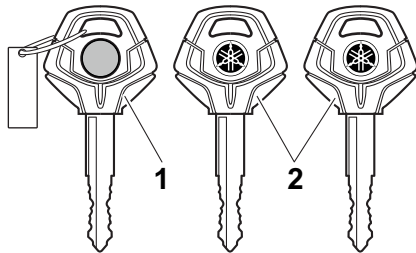

1. Code re-registering key (red dot)
2. Standard keys (black bow)

This vehicle is equipped with an immobilizer system to help prevent theft by re-registering codes in the standard keys. This system consists of the following:

- a code re-registering key
- two standard keys
- a transponder (in each key)
- an immobilizer unit (on the vehicle)
- an ECU (on the vehicle)
- a system indicator light (page 3-5)

About the keys

The code re-registering key acts like a master key. It is used to register codes in each standard key. Store the code re-registering key in a safe place. Use a standard key for daily operation.

When key replacement or re-registering is necessary, bring the vehicle and the master key along with any remaining standard keys to a Yamaha dealer to have them re-registered.

TIP

- Keep the standard keys as well as keys of other immobilizer systems away from the code re-registering key.
- Keep other immobilizer system keys away from the main switch as they may cause signal interference.

ECA11823

NOTICE

DO NOT LOSE THE CODE RE-REGISTERING KEY! CONTACT YOUR DEALER IMMEDIATELY IF IT IS LOST! If the code re-registering key is lost, the existing standard keys can still be used to start the vehicle.

However, registering a new standard key is impossible. If all keys have been lost or damaged, the entire immobilizer system must be replaced. Therefore, handle the keys carefully.

- Do not submerge in water.
- Do not expose to high temperatures.
- Do not place near magnets.
- Do not place near items that transmit electrical signals.
- Do not handle roughly.
- Do not grind or alter.
- Do not disassemble.
- Do not put two keys of any immobilizer system on the same key ring.

Main switch/steering lock

EAU10462

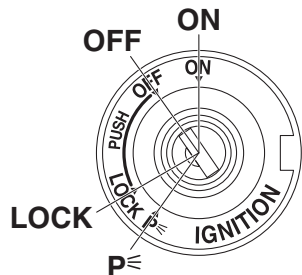

The main switch/steering lock controls the ignition and lighting systems, and is used to lock the steering. The various positions are described below.

ON

EAU85050

All electrical circuits are supplied with power and the vehicle lights are turned on. The engine can be started. The key cannot be removed.

TIP

- To prevent battery discharge, do not leave the key in the on position without the engine running.
- The headlight comes on automatically when the engine is started.

- The headlight will stay on until the key is turned to “OFF”, even if the engine stalls.

OFF

EAU10662

All electrical systems are off. The key can be removed.

⚠ WARNING

EWA10062

Never turn the key to “OFF” or “LOCK” while the vehicle is moving. Otherwise the electrical systems will be switched off, which may result in loss of control or an accident.

LOCK

EAU1068B

The steering is locked and all electrical systems are off. The key cannot be removed.

To lock the steering

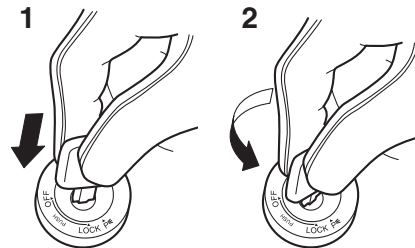

1. Push.
2. Turn.

1. Turn the handlebars all the way to the left.
2. With the key in the “OFF” position, push the key in and turn it to “LOCK”.
3. Remove the key.

TIP

If the steering will not lock, try turning the handlebars back to the right slightly.

Instrument and control functions

To unlock the steering

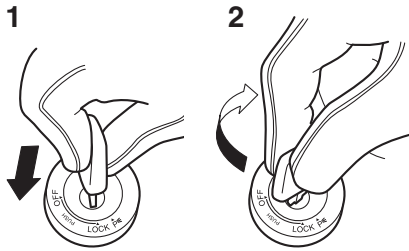

1. Push.
2. Turn.

From the “LOCK” position, push the key in and turn it to “OFF”.

p< (Parking)

The hazard lights and turn signal lights can be turned on, but all other electrical systems are off. The key can be removed.

The steering must be locked before the key can be turned to “p<”.

NOTICE

Using the hazard or turn signal lights for an extended length of time may cause the battery to discharge.

Indicator lights and warning lights

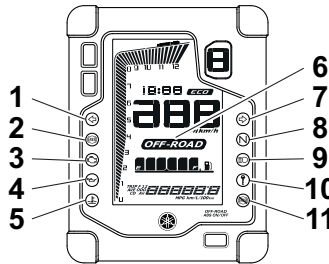

1. Left turn signal indicator light “↶”
2. Anti-lock Brake System (ABS) warning light “(ABS)”
3. Engine trouble warning light “(E)”
4. Oil pressure warning light “(O)”
5. Coolant temperature warning light “(T)”
6. “OFF-ROAD” indicator
7. Right turn signal indicator light “↷”
8. Neutral indicator light “N”
9. High beam indicator light “(H)”
10. Immobilizer system indicator light “(I)”
11. Anti-lock Brake System (ABS OFF) warning light “(ABS OFF)”

Turn signal indicator lights “↶” and “↷”

Each indicator light will flash when its corresponding turn signal lights are flashing.

Neutral indicator light “N”

This indicator light comes on when the transmission is in the neutral position.

High beam indicator light “(H)”

This indicator light comes on when the high beam of the headlight is switched on.

Oil pressure warning light “(O)”

This warning light comes on if the engine oil pressure is low.

TIP

When the vehicle is turned on, the light should come on, go off briefly, and then remain on until the engine is started. Otherwise, have a Yamaha dealer check the vehicle.

NOTICE

ECA21211

If the warning light comes on when the engine is running, stop the engine and check the oil level. If the oil level is low, add sufficient oil of the recommended type. If the warning light remains on after adding oil, stop the engine and have a Yamaha dealer check the vehicle.

Coolant temperature warning light “”

EAU11449

This warning light comes on when the engine is overheating. If this occurs, stop the engine immediately and allow the engine to cool. (See page 6-37.) For vehicles with a radiator fan, the radiator fan(s) automatically switch on or off according to the coolant temperature.

TIP

When the vehicle is turned on, the light will come on for a few seconds, and then go off. If the light does not come on, or if the light remains on, have a Yamaha dealer check the vehicle.

NOTICE

ECA10022

Do not continue to operate the engine if it is overheating.

Engine trouble warning light “”

EAU73172

This warning light comes on if a problem is detected in the engine or other vehicle control system. If this occurs, have a Yamaha dealer check the on-board diagnostic system.

TIP

When the vehicle is turned on, the light will come on for a few seconds and then go off. If the light does not come on, or if the light remains on, have a Yamaha dealer check the vehicle.

ABS warning light “”

EAU69895

This warning light comes on when the vehicle is first turned on, and goes off after starting riding. If the warning light comes on while riding, the anti-lock brake system may not work correctly.

WARNING

EWA16043

If the ABS warning light does not turn off after reaching 10 km/h (6 mi/h), or if the warning light comes on while riding:

- Use extra caution to avoid possible wheel lock during emergency braking.
- Have a Yamaha dealer check the vehicle as soon as possible.

ABS warning light “”

EUM4080

This warning light comes on when the anti-lock brake system has been manually disabled, the “OFF-ROAD” indicator comes on at the same time.

WARNING

EWA10050

Always ride on paved roads with the ABS turned on. Riding on public roads with the ABS disabled may be illegal and void your insurance. Turn the ABS off only when riding on non-paved surfaces.

Instrument and control functions

EAUM3622

Immobilizer system indicator light “ \uparrow ”

When the vehicle is turned off and 30 seconds have passed, the indicator light will flash steadily to indicate the immobilizer system is enabled. After 24 hours have passed, the indicator light will stop flashing, however the immobilizer system is still enabled.

TIP

When the vehicle is turned on, the light will come on for a few seconds, and go off. Otherwise, have a Yamaha dealer check the vehicle.

Troubleshooting

If a problem is detected in the immobilizer system, the light will flash in a pattern. If the immobilizer system indicator light flashes in the pattern, slowly 5 times then quickly 2 times, this could be caused by transponder interference. If this occurs, try the following.

1. Make sure there are no other immobilizer keys close to the main switch. Other immobilizer system

keys may cause signal interference and prevent the engine from starting.

2. Use the code re-registering key to start the engine.
3. If the engine starts, turn it off, and try starting the engine with the standard keys.
4. If one or more of the standard keys do not start the engine, take the vehicle and all keys to a Yamaha dealer to have the standard keys re-registered.

Multi-function meter unit

EAUM4172

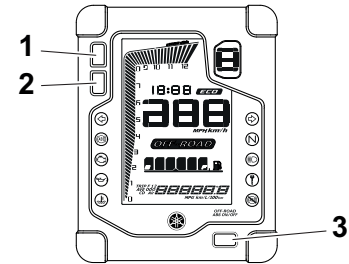

1. Top set button
2. Bottom set button
3. “OFF-ROAD ABS ON/OFF” button

Instrument and control functions

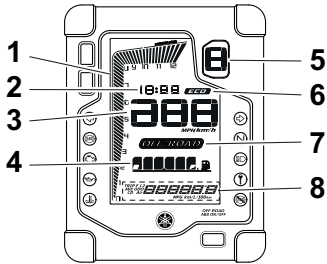

1. Tachometer
2. Clock
3. Speedometer
4. Fuel meter
5. Transmission gear display
6. Eco indicator "ECO"
7. "OFF-ROAD" indicator
8. Multi-function display

The multi-function meter unit is equipped with the following:

- speedometer
- tachometer
- fuel meter
- clock
- eco indicator
- transmission gear display
- OFF-ROAD indicator
- multi-function display

TIP

- To switch between kilometers and miles, set the multi-function display to the odometer or a tripmeter, and then push the top set button until the display units change.
- The display units will return to factory settings in case of battery disconnection.

EWA12423

WARNING

Be sure to stop the vehicle before making any setting changes to the multi-function meter unit. Changing settings while riding can distract the operator and increase the risk of an accident.

Speedometer

The speedometer shows the vehicle's traveling speed.

Tachometer

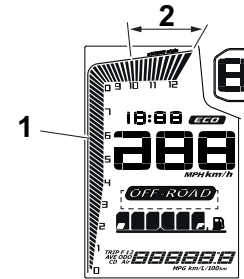

1. Tachometer
2. Tachometer red zone

The tachometer shows the engine speed.

ECA23050

NOTICE

Do not operate the engine in the tachometer high-r/min zone.

High-r/min zone: 10000 r/min and above

Instrument and control functions

Fuel meter

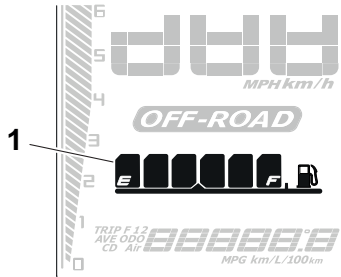

3

1

1. Fuel meter

The fuel meter indicates the amount of fuel in the fuel tank. The segments of the fuel meter disappear from “F” (full) towards “E” (empty) as the fuel level decreases. When the last segment of the fuel meter starts flashing, refuel as soon as possible.

TIP

If a problem is detected in the electrical circuit, the fuel meter segments will flash repeatedly. If this occurs, have a Yamaha dealer check the vehicle.

Eco indicator

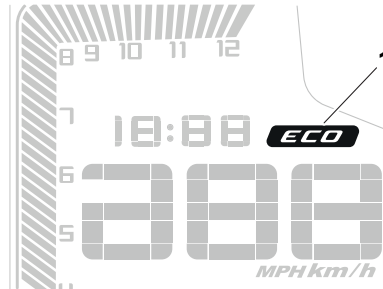

1. Eco indicator “ECO”

This indicator comes on when the vehicle is being operated in an environmentally friendly, fuel-efficient manner. The indicator goes off when the vehicle is stopped.

TIP

Consider the following tips to reduce fuel consumption:

- Avoid high engine speeds during acceleration.
- Travel at a constant speed.
- Select the transmission gear that is appropriate for the vehicle speed.

Transmission gear display

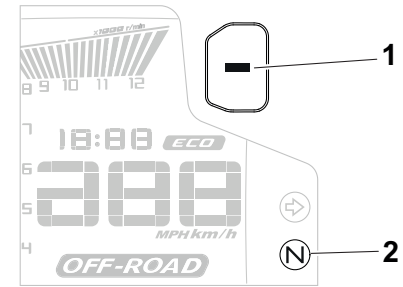

1. Transmission gear display

2. Neutral indicator light “N”

The transmission gear display shows the selected gear. The neutral position is indicated by “-”.

Clock

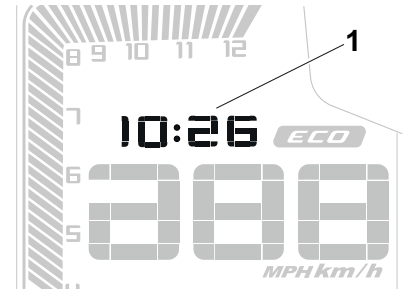

1. Clock

Instrument and control functions

The clock uses a 12-hour time system.

TIP

When the main switch is turned off, the clock can be viewed by pushing the top set button.

To set the clock

1. Turn the key to “ON”.
2. Push the bottom set button and top set button together until the hour digits start flashing.
3. Push the bottom set button to set the hours.
4. Push the top set button and the minute digits will start flashing.
5. Push the bottom set button to set the minutes.
6. Push the top set button to confirm settings and start the clock.

TIP

When setting the hours and minutes, push the bottom set button briefly to increase the increment value one by one, or push and hold the button to increase the increment value continuously.

OFF-ROAD Indicator

This indicator comes on when the ABS has been manually disabled.

To switch off the ABS

1. Turn the key to “ON”.
2. The vehicle being stationary, push the “OFF-ROAD ABS ON/OFF” button until the “ABS OFF” warning light starts flashing, then release the button.
3. The “ABS OFF” warning light and “OFF-ROAD” indicator will come on simultaneously.

TIP

The ABS will be disabled until the key is turned to “OFF”, or the engine stop switch is turned to “” (stop) when the engine is running or you stop the vehicle and push the “OFF-ROAD ABS ON/OFF” button again. The “ABS OFF” warning light and the “OFF-ROAD” indicator will turn off.

EWAM1050



Always ride on paved roads with the ABS turned on. Riding on public roads with the ABS disabled may be

illegal and void your insurance. Turn the ABS off only when riding on non-paved surfaces.

Multi-function display

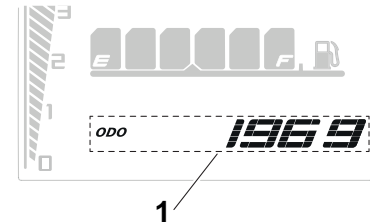

1. Multi-function display

The multi-function display can show:

- an odometer
- two tripmeters
- a countdown tripmeter
- a fuel reserve tripmeter
- an instantaneous fuel consumption display
- an average fuel consumption display
- a coolant temperature display
- an air temperature display
- a brightness control mode

Instrument and control functions

3

The odometer shows the total distance the vehicle has traveled. The standard tripmeters show the distance traveled since they were last reset. The countdown tripmeter shows the remaining distance to travel since it was last set. The fuel reserve tripmeter shows the distance traveled since the last segment of the fuel meter began flashing.

TIP

- The odometer will lock at 999999 and cannot be reset.
- The tripmeter will reset to 0 and continue counting after 9999.9 is reached.
- The countdown tripmeter does not automatically reset.

Push the top set button to switch the display in the following order:

ODO → TRIP 1 → TRIP 2 → TRIP CD → TRIP F → km/L or L/100 km or MPG → AVE_ _ _ km/L or AVE_ _ _ L/100 km or AVE_ _ _ MPG → _ _ °C → Air_ _ °C → ODO

TIP

- Push the bottom set button to switch the display in the reverse order.
- The display changes to fuel reserve tripmeter “TRIP F” when the last segment of the fuel meter starts flashing.
- To reset a tripmeter, select it by pushing the top set button, and while the digits flash, push the bottom set button until it is reset.
- If you do not reset the fuel reserve tripmeter manually, it will reset automatically and disappear from the display after refueling and traveling 5 km (3 mi).

Fuel reserve tripmeter

When the fuel level becomes low, the last segment of the fuel meter will start flashing. The fuel reserve tripmeter “TRIP F” will automatically appear and start counting the distance traveled from that point. In this case, push the top set button to switch the display in the following order:

TRIP F → km/L or L/100 km → AVE_ _ _ km/L or AVE_ _ _ L/100 km → _ _ °C → Air_ _ °C → ODO → TRIP 1 → TRIP 2 → TRIP CD → TRIP F

For the UK:

TRIP F → km/L, L/100 km or MPG → AVE_ _ _ km/L, AVE_ _ _ L/100 km or AVE_ _ _ MPG → _ _ °C → Air_ _ °C → ODO → TRIP 1 → TRIP 2 → TRIP CD → TRIP F

TIP

- Push the bottom set button to change the display in the reverse order.
- You can manually reset the fuel reserve tripmeter, or after refueling and traveling 5 km (3 mi) it will reset automatically and disappear from the display.

Countdown tripmeter settings

To set the countdown tripmeter, select it by pushing the top set button. When the units stop flashing, push the top and bottom set buttons simultaneously until the first digit starts flashing. A

short press on the top button will increment the unit from “9” to “0”. Push the bottom set button to select the next digit and set it following the same procedure as the first digit. Push the bottom set button to select the last digit and follow the same procedure. Push the bottom set button to confirm the value.

TIP

- The maximum possible entering value is 900 km or 600 mi.
- The countdown tripmeter will start as soon as you begin riding. When the countdown reaches “0” the display changes to the countdown tripmeter “TRIP CD” and flashes 10 times.
- To reset the countdown tripmeter, select it and while the digits flash, push the bottom set button until it is reset.

Instantaneous fuel consumption

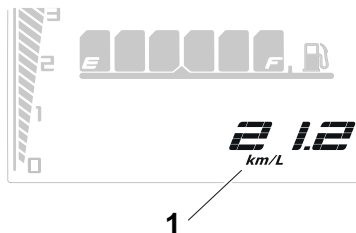

1. Instantaneous fuel consumption display

This function calculates the fuel consumption under current riding conditions.

The instantaneous fuel consumption display can be set to either “km/L”, “L/100 km” when using kilometers.

To switch the the fuel consumption units, push the top set button until the measurement units change. When using miles, the fuel consumption unit is “MPG”.

- “km/L”: The distance that can be traveled on 1.0 L of fuel under the current riding conditions is shown.

- “L/100 km”: The amount of fuel necessary to travel 100 km under the current riding conditions is shown.
- “MPG”: The distance that can be traveled on 1.0 Imp.gal of fuel under the current riding conditions is shown.

To switch the instantaneous fuel consumption settings, push and hold the left set button until the display changes.

TIP

If traveling at speeds under 20 km/h (12 mi/h), “_ _ . _” is displayed.

Average fuel consumption

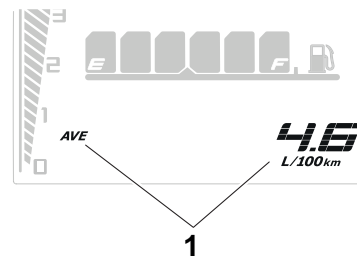

1. Average fuel consumption display

Instrument and control functions

3

This display shows the average fuel consumption since it was last reset.

The average fuel consumption can be set to either “AVE_ _ km/L”, “AVE_ _ L/100 km” when using kilometers.

To switch the fuel consumption units, push the top set button until the measurement units change. When using miles, the fuel consumption is “AVE_ _ MPG”.

- “AVE_ _ km/L”: The average distance that can be traveled on 1.0 L of fuel is shown.
- “AVE_ _ L/100 km”: The average amount of fuel necessary to travel 100 km is shown.
- “AVE_ _ MPG”: The average distance that can be traveled on 1.0 Imp.gal of fuel is shown.

To reset the average fuel consumption, select it and while the digits flash push the bottom set button until it is reset.

TIP _____
After resetting the average fuel consumption, “_ _.” will be shown until the vehicle has traveled 1 km (0.6 mi).

Coolant temperature

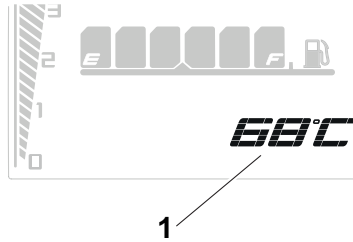

1. Coolant temperature display

This display shows the coolant temperature from 40 °C to 116 °C in 1 °C increments.

If the message “Hi” flashes, stop the vehicle, then stop the engine, and let it cool. (See page 6-37.)

TIP _____

- When the coolant temperature is below 40 °C, “Lo” will be displayed.
- The coolant temperature varies with changes in the weather and engine load.

Air temperature

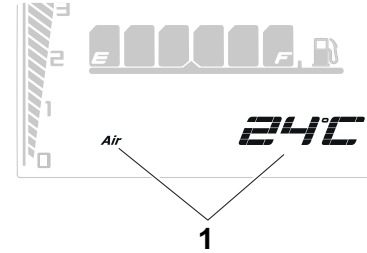

1. Air temperature display

This display shows the air temperature from -9 °C to 99 °C in 1 °C increments.

TIP _____

- When the temperature is below -9 °C, “Lo” will be displayed.
- The temperature displayed may vary from the ambient temperature.

Brightness control mode

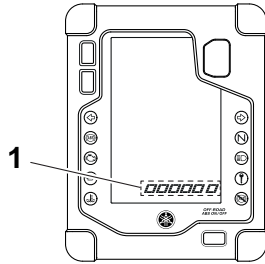

1. Brightness level display

The brightness level of the multi-function meter unit panel can be adjusted.

To adjust the brightness



1. Turn the key to “OFF”.
2. Push and hold the top set button.
3. Turn the key to “ON” and continue pushing the top set button until the display switches to the brightness control mode.
4. Push the bottom set button to set the brightness level.
5. Push the top set button to confirm the selected brightness level and exit the brightness control mode.

TIP _____
There are 6 brightness level settings.

Handlebar switches

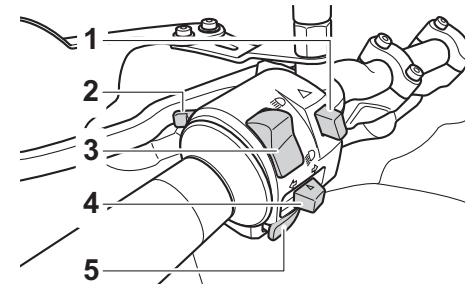
Left

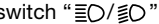
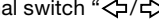

1. Hazard switch “”
2. Pass switch “PASS”
3. Dimmer switch “”
4. Turn signal switch “”
5. Horn switch “”

Instrument and control functions

Right

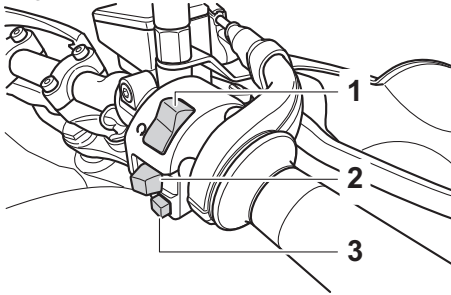

3

1. Engine stop switch “/”
2. “SELECT” switch
3. Start switch “”

EAU12362

Pass switch “PASS”

Press this switch to flash the headlight.

TIP

When the dimmer switch is set to “”, the passing switch has no effect.

EAUM4180

Dimmer switch “/”

Set this switch to “” for the high beam and to “” for the low beam.

TIP

When the switch is set to low beam, both headlights for low beam come on.

When the switch is set to high beam, both headlights for high beam and both headlights for low beam come on.

EAU12461

Turn signal switch “/”

To signal a right-hand turn, push this switch to “”. To signal a left-hand turn, push this switch to “”. When released, the switch returns to the center position. To cancel the turn signal lights, push the switch in after it has returned to the center position.

EAU12501

Horn switch “”

Press this switch to sound the horn.

EAU12663

Engine stop switch “/”

Set this switch to “” (run) before starting the engine. Set this switch to “” (stop) to stop the engine in case of an emergency, such as in the event of an overturn or if the throttle is stuck.

EAU12713

Start switch “”

Push this switch to crank the engine with the starter. See page 5-2 for starting instructions prior to starting the engine.

EAU12735

Hazard switch “”

With the key in the “ON” or “” position, use this switch to turn on the hazard lights (simultaneous flashing of all turn signal lights).

The hazard lights are used in case of an emergency or to warn other drivers when your vehicle is stopped where it might be a traffic hazard.

ECA10062

NOTICE

Do not use the hazard lights for an extended length of time with the engine not running, otherwise the battery may discharge.

EAUM4090

“SELECT” switch

This switch has the same functions as the bottom set button of the Multi-function meter unit.

See “Multi-function meter unit” on page 3-5 for detailed information.

Clutch lever

EAU12823

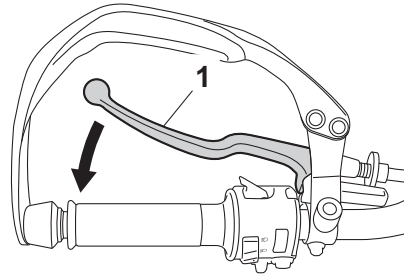

1. Clutch lever

To disengage the drivetrain from the engine, such as when shifting gears, pull the clutch lever toward the handlebar. Release the lever to engage the clutch and transmit power to the rear wheel.

TIP

The lever should be pulled rapidly and released slowly for smooth shifting. (See page 5-3.)

Shift pedal

EAU12876

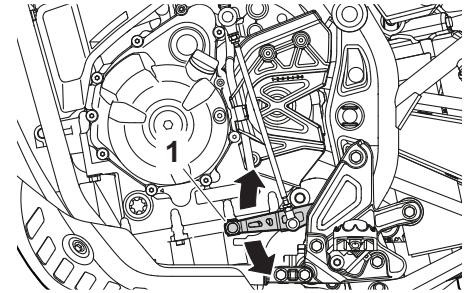

1. Shift pedal

The shift pedal is located on the left side of the motorcycle. To shift the transmission to a higher gear, move the shift pedal up. To shift the transmission to a lower gear, move the shift pedal down. (See page 5-3.)

Instrument and control functions

EAU26827

Brake lever

The brake lever is located on the right side of the handlebar. To apply the front brake, pull the lever toward the throttle grip.

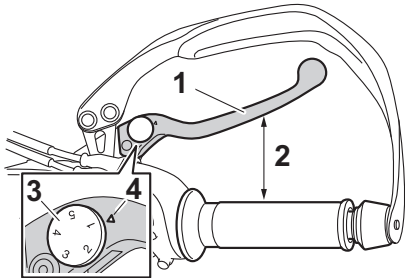

1. Brake lever
2. Distance between brake lever and throttle grip
3. Brake lever position adjusting dial
4. Match mark

The brake lever is equipped with a brake lever position adjusting dial. To adjust the distance between the brake lever and the throttle grip, push the brake lever away from the throttle grip and rotate the adjusting dial. Make sure the setting number on the adjusting dial aligns with the match mark on the brake lever.

EAU12944

Brake pedal

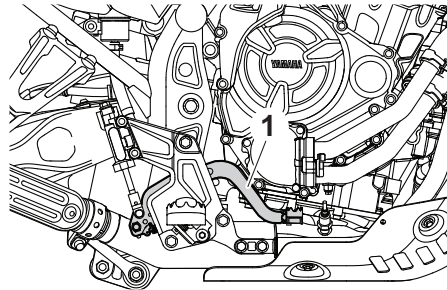

1. Brake pedal

The brake pedal is located on the right side of the motorcycle. To apply the rear brake, press down on the brake pedal.

EAU4100

ABS

The anti-lock brake system (ABS) acts on the front and rear brakes independently.

EWA16051

WARNING

Always keep a sufficient distance from the vehicle ahead to match the riding speed even with ABS.

- The ABS performs best with long braking distances.
- On certain surfaces, such as rough or gravel roads, the braking distance may be longer with the ABS than without.

How to operate the brakes

Operate the brake lever and brake pedal the same as you would conventional brakes. If wheel slip is detected while braking, ABS will activate and a pulsating sensation may be felt at the brake lever or brake pedal. Continue to apply the brakes and let the ABS work. Do not pump the brakes as this will reduce braking effectiveness.

- The ABS performs a self-check when you first start off. During this time a clicking noise from the hydraulic unit may be audible, and if the brake lever or brake pedal is applied a vibration can be felt, but this is not a malfunction.
- The brake system will revert to a conventional brake system in case of ABS malfunction.

ECA20100

NOTICE

Be careful not to damage the wheel sensor or wheel sensor rotor; otherwise, improper performance of the ABS will result.

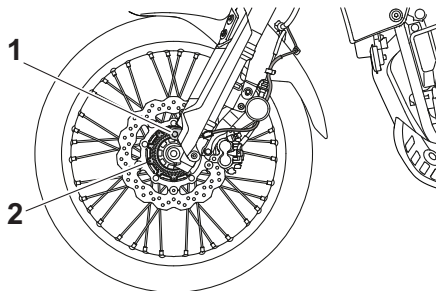

1. Front wheel sensor
2. Front wheel sensor rotor

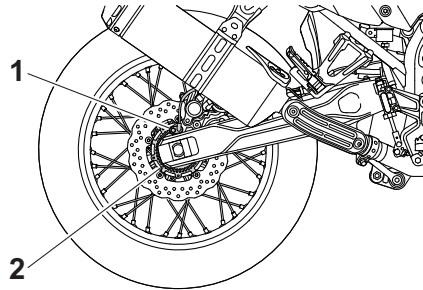

1. Rear wheel sensor
2. Rear wheel sensor rotor

TIP

When riding off-road, the ABS can be disabled. (See page 3-8.)

EWAM1050

WARNING

Always ride on paved roads with the ABS turned on. Riding on public roads with the ABS disabled may be illegal and void your insurance. Turn the ABS off only when riding on non-paved surfaces.

Fuel tank cap

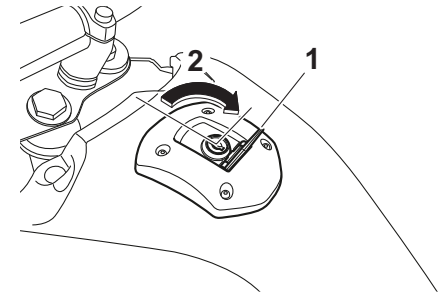

1. Fuel tank cap lock cover
2. Unlock.

To remove the fuel tank cap

1. Open the fuel tank cap lock cover.
2. Insert the key into the lock and turn it 1/4 turn clockwise. The lock will be released and the fuel tank cap can be removed.

To install the fuel tank cap

1. Push and install the fuel tank cap into position with the key inserted in the lock.
2. Turn the key counterclockwise to the original position, and then remove it.

Instrument and control functions

TIP _____

The fuel tank cap cannot be installed unless the key is in the lock. In addition, the key cannot be removed if the cap is not properly installed and locked.

3. Close the lock cover.

EWA11142

⚠ WARNING _____

Make sure that the fuel tank cap is properly installed before riding. Leaking fuel is a fire hazard.

Fuel

Make sure there is sufficient gasoline in the tank.

EAU13222

EWA10882

⚠ WARNING _____

Gasoline and gasoline vapors are extremely flammable. To avoid fires and explosions and to reduce the risk of injury when refueling, follow these instructions.

1. Before refueling, turn off the engine and be sure that no one is sitting on the vehicle. Never refuel while smoking, or while in the vicinity of sparks, open flames, or other sources of ignition such as the pilot lights of water heaters and clothes dryers.
2. Do not overfill the fuel tank. When refueling, be sure to insert the pump nozzle into the fuel tank filler hole. Stop filling when the fuel reaches the bottom of the filler tube. Because fuel expands when it heats up, heat from the engine or the sun can cause fuel to spill out of the fuel tank.

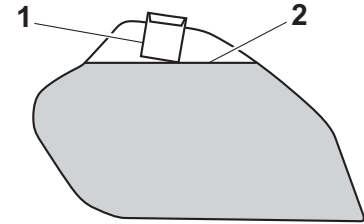

1. Fuel tank filler tube
2. Maximum fuel level

3. Wipe up any spilled fuel immediately. **NOTICE: Immediately wipe off spilled fuel with a clean, dry, soft cloth, since fuel may deteriorate painted surfaces or plastic parts.** [ECA10072]
4. Be sure to securely close the fuel tank cap.

EWA15152

⚠ WARNING _____

Gasoline is poisonous and can cause injury or death. Handle gasoline with care. Never siphon gasoline by mouth. If you should swallow some gasoline or inhale a lot of gasoline vapor, or get some gasoline in your eyes, see your doctor immedi-

ately. If gasoline spills on your skin, wash with soap and water. If gasoline spills on your clothing, change your clothes.

EAU76860

Recommended fuel:

Premium unleaded gasoline (E10 acceptable)

Fuel tank capacity:

16 L (4.2 US gal, 3.5 Imp.gal)

Fuel reserve amount:

4.3 L (1.14 US gal, 0.95 Imp.gal)

ECA11401

NOTICE

Use only unleaded gasoline. The use of leaded gasoline will cause severe damage to internal engine parts, such as the valves and piston rings, as well as to the exhaust system.

**TIP**

- This mark identifies the recommended fuel for this vehicle as specified by European regulation (EN228).
- Check that gasoline nozzle has the same identifier when fueling.

Your Yamaha engine has been designed to use regular unleaded gasoline with a research octane number of 95 or higher. If knocking (or pinging) occurs, use a gasoline of a different brand or premium unleaded fuel. Use of unleaded fuel will extend spark plug life and reduce maintenance costs.

Gasohol

There are two types of gasohol: gasohol containing ethanol and that containing methanol. Gasohol containing ethanol can be used if the ethanol content does not exceed 10% (E10). Gasohol containing methanol is not recommended by Yamaha because it can cause damage to the fuel system or vehicle performance problems.

Instrument and control functions

Fuel tank overflow hose

EAU80200

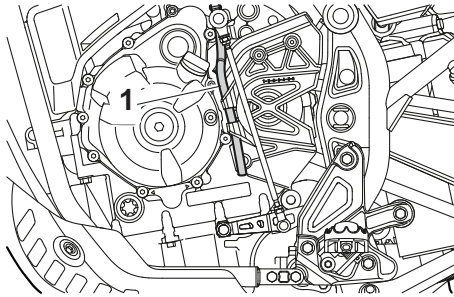

1. Canister breather hose

Before operating the vehicle:

- Check the fuel tank overflow hose connection.
- Check the fuel tank overflow hose for cracks or damage, and replace it if necessary.
- Make sure that the end of the fuel tank overflow hose is not blocked, and clean it if necessary.
- Make sure that the end of the fuel tank overflow hose is positioned as shown.

TIP

See page 6-10 for canister information.

Catalytic converter

EAU13435

The exhaust system contains catalytic converter(s) to reduce harmful exhaust emissions.

EWA10863

⚠ WARNING

The exhaust system is hot after operation. To prevent a fire hazard or burns:

- Do not park the vehicle near possible fire hazards such as grass or other materials that easily burn.
- Park the vehicle in a place where pedestrians or children are not likely to touch the hot exhaust system.
- Make sure that the exhaust system has cooled down before doing any maintenance work.
- Do not allow the engine to idle more than a few minutes. Long idling can cause a build-up of heat.

Seats

EAU4110

Passenger seat

To remove the passenger seat

1. Insert the key into the seat lock, and then turn the key counter-clockwise.

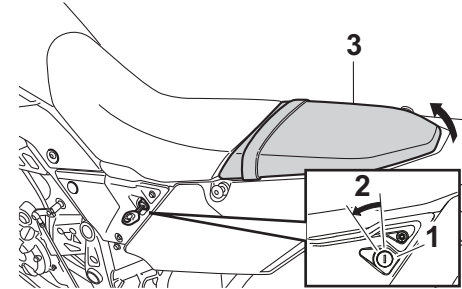

1. Seat lock
2. Unlock.
3. Passenger seat

2. Lift the rear of the passenger seat and pull it backward.

Instrument and control functions

To install the passenger seat

1. Insert the projection on the front of the passenger seat into the seat holder as shown, and then push the rear of the seat down to lock it in place.

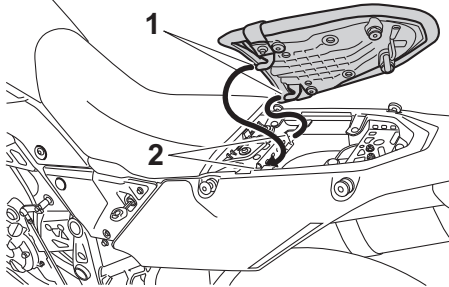

1. Projection
2. Seat holder

2. Remove the key.

Rider seat

To remove the rider seat

1. Remove the passenger seat, and then remove the hexagon wrench located on the rear of the rider seat.

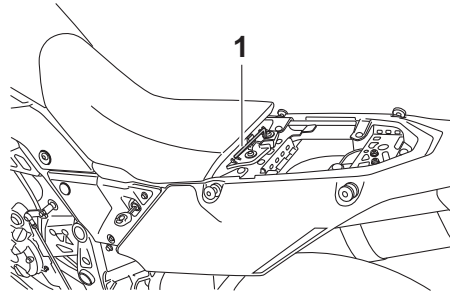

1. Hexagon wrench

2. Remove the bolts with the hexagon wrench.

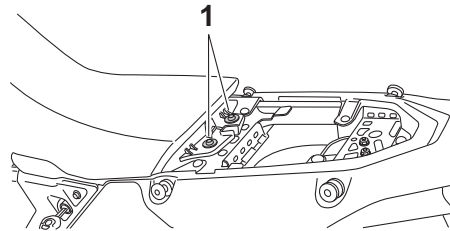

1. Bolt

3. Lift the rear of the rider seat and pull it backward.

To install the rider seat

1. Insert the projection on the front of the rider seat into the seat holder as shown, and then place the seat in the original position.

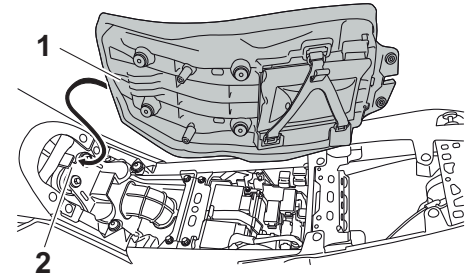

1. Projection
2. Slot

2. Install the bolts with the hexagon wrench.
3. Insert the hexagon wrench back into its holder on the rider seat.
4. Install the passenger seat.

TIP

Make sure that the seats are properly secured before riding.

Instrument and control functions

3

EAU39612

Adjusting the headlight beams

The headlight beam adjusting knobs are used to raise or lower the height of the headlight beams. It may be necessary to adjust the headlight beams to increase visibility and help prevent blinding oncoming drivers when carrying more or less load than usual. Obey local laws and regulations when adjusting the headlights.

To raise the headlight beams, turn the knobs in direction (a). To lower the headlight beams, turn the knobs in direction (b).

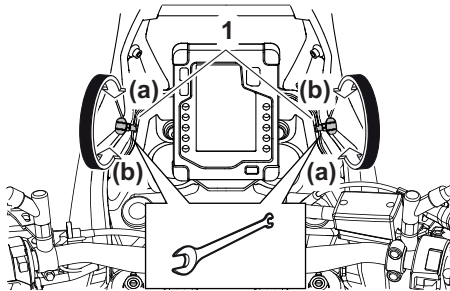

1. Headlight beam adjusting knob

EAU45205

EWA10181

Adjusting the front fork

⚠ WARNING

Always adjust both fork legs equally, otherwise poor handling and loss of stability may result.

This front fork is equipped with rebound damping force adjusting screws and compression damping force adjusting screws.

ECA10102

NOTICE

To avoid damaging the mechanism, do not attempt to turn beyond the maximum or minimum settings.

Rebound damping force

Turn the adjusting screw in direction (a) to increase the rebound damping force.

Turn the adjusting screw in direction (b) to decrease the rebound damping force.

To set the rebound damping force, turn the adjuster in direction (a) until it stops, and then count the clicks in direction (b).

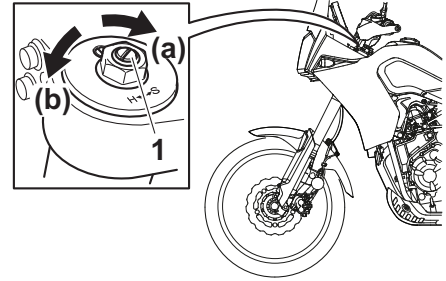

1. Rebound damping force adjusting screw

Rebound damping setting:

Minimum (soft):

31 click(s) in direction (b)

Standard:

17 click(s) in direction (b)

Maximum (hard):

0 click(s) in direction (b)

TIP

- When turning the damping force adjuster in direction (a), the 0 click position and the 1 click position may be the same.
- When turning the damping force adjuster in direction (b), it may click beyond the stated specifica-

tions, however such adjustments are ineffective and may damage the suspension.

Compression damping force

1. Remove the rubber cap by pulling it out of the front fork leg.

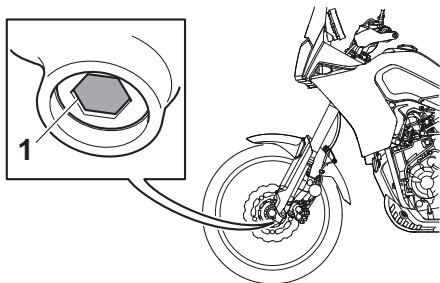

1. Rubber cap

2. Turn the adjusting screw in direction (a) to increase the compression damping force. Turn the adjusting screw in direction (b) to decrease the compression damping force. To set the compression damping force, turn the adjuster in direction (a) until it stops, and then count the clicks in direction (b).

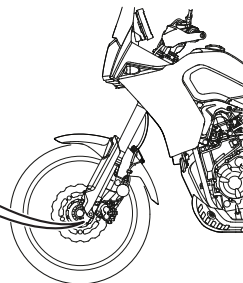
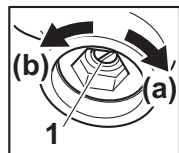

1. Compression damping force adjusting screw

Compression damping setting:

Minimum (soft):
22 click(s) in direction (b)

Standard:
11 click(s) in direction (b)

Maximum (hard):
0 click(s) in direction (b)

3. Install the rubber cap.

TIP

- When turning the damping force adjuster in direction (a), the 0 click position and the 1 click position may be the same.
- When turning the damping force adjuster in direction (b), it may click beyond the stated specifica-

tions, however such adjustments are ineffective and may damage the suspension.

Instrument and control functions

3

Front fork bleeding

EAU14796

When riding in extremely rough conditions, the air temperature and pressure in the front fork will rise and harden the suspension. If this occurs, bleed the air from each fork leg.

EWA10201

⚠ WARNING

Always bleed both fork legs, otherwise poor handling and loss of stability may result.

1. If possible, elevate the vehicle so the front wheel is off the ground. (See page 6-34.)

TIP

When bleeding the front fork, do not apply any pressure or weight on the front end of the vehicle.

2. Remove the bleed screws and allow all of the air to escape from each fork leg.

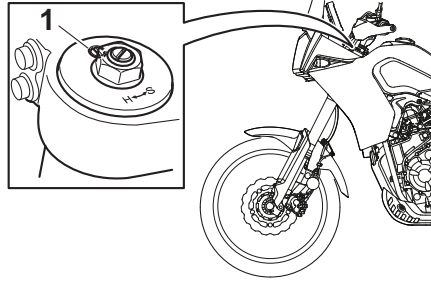

1. Bleed screw
3. Install the bleed screws.
4. Lower the front wheel so that it is on the ground, and then put the sidestand down.

Adjusting the shock absorber assembly

EAUM4120

This shock absorber assembly is equipped with a spring preload adjuster and rebound and compression damping force adjusters.

ECA10102

NOTICE

To avoid damaging the mechanism, do not attempt to turn beyond the maximum or minimum settings.

Spring preload

Turn the adjuster in direction (a) to increase the spring preload. Turn the adjuster in direction (b) to decrease the spring preload.

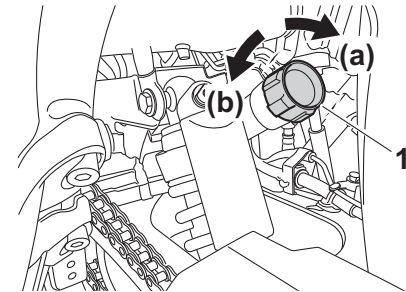

1. Spring preload adjusting knob

Spring preload setting:

Unit for adjustment:

Click

Minimum (soft):

0

Standard:

10

Maximum (hard):

24

TIP

- When turning the spring preload adjuster in direction (b), the 0 click position and the 1 click position may be the same.
- When turning the spring preload adjuster in direction (a), it may click beyond the stated specifications, however such adjustments are ineffective and may damage the suspension.

Rebound damping force

Turn the adjuster in direction (a) to increase the rebound damping force.

Turn the adjuster in direction (b) to decrease the rebound damping force.

To set the rebound damping force, turn the adjuster in direction (a) until it stops, and then count the clicks in direction (b).

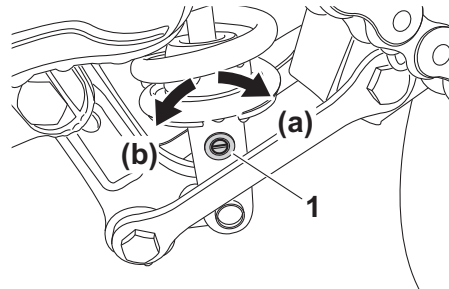

1. Rebound damping force adjusting screw

Rebound damping setting:

Unit for adjustment:

Click

Minimum (soft):

23

Standard:

13

Maximum (hard):

0

TIP

- When turning the damping force adjuster in direction (a), the 0 click position and the 1 click position may be the same.

- When turning the damping force adjuster in direction (b), it may click beyond the stated specifications, however such adjustments are ineffective and may damage the suspension.

Compression damping force

Turn the adjuster in direction (a) to increase the compression damping force.

Turn the adjuster in direction (b) to decrease the compression damping force.

To set the compression damping force, turn the adjuster in direction (a) until it stops, and then count the clicks in direction (b).

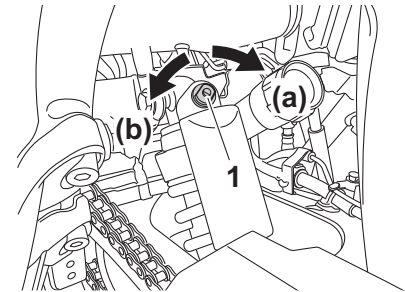

1. Compression damping force adjusting screw

Instrument and control functions

3

Compression damping setting:

Unit for adjustment:

Click

Minimum (soft):

18

Standard:

15

Maximum (hard):

0

TIP

- When turning the damping force adjuster in direction (a), the 0 click position and the 1 click position may be the same.
- When turning the damping force adjuster in direction (b), it may click beyond the stated specifications, however such adjustments are ineffective and may damage the suspension.

EWA10222

WARNING

This shock absorber assembly contains highly pressurized nitrogen gas. Read and understand the following information before handling the shock absorber assembly.

- Do not tamper with or attempt to open the cylinder assembly.
- Do not subject the shock absorber assembly to an open flame or other high heat source. This may cause the unit to explode due to excessive gas pressure.
- Do not deform or damage the cylinder in any way. Cylinder damage will result in poor damping performance.
- Do not dispose of a damaged or worn-out shock absorber assembly yourself. Take the shock absorber assembly to a Yamaha dealer for any service.

Luggage strap holders

EAU84680

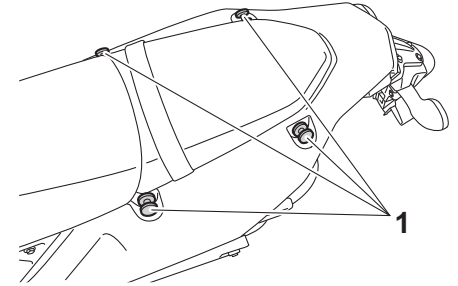

1. Luggage strap holder

Use the indicated strap points to secure luggage ties to the vehicle.

Front fender

EAUM4130

To suit the riding conditions, the front fender height can be adjusted.

To adjust the front fender height

1. Loosen the bolts on each side of the front fender.

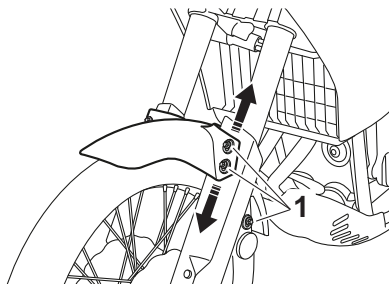

1. Bolt
2. Move the front fender to the desired height.
3. Tighten the bolts to the specified torque.

Tightening torque:

Front fender bolt:
7.5 N·m (0.75 kgf·m, 5.6 lb-ft)

DC power outlets

EAUM4201

This vehicle is equipped with an auxiliary DC jack, and auxiliary DC connector, a grip warmer connector and a fog lamp DC connector.

NOTICE

Do not use any single electrical accessory or combination of accessories that require more than the stated capacity at any one time. This may overload the circuit and cause the fuse to blow.

ECA26810

DC power outlet circuit capacities:

DC jack and DC connector circuit:
24 W (2 A)
Grip warmer and Fog lamp circuit:
120 W (10 A)

TIP

To prevent battery drain, do not use an accessory with the engine off.

Auxiliary DC jack

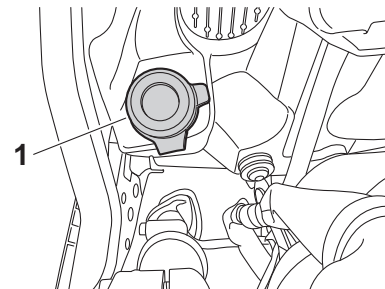

1. Auxiliary DC jack cap

A 12-V accessory with the proper connector can be used when the main switch is on.

To use the auxiliary DC jack

1. Turn the vehicle power off.
2. Remove the auxiliary DC jack cap.
3. Turn the accessory off.
4. Insert the accessory plug into the auxiliary DC jack.

Instrument and control functions

3

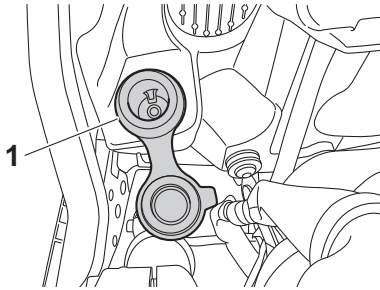

1. Auxiliary DC jack

5. Turn the vehicle power on, and start the engine.
6. Turn the accessory on.

TIP

When finished riding, be sure to turn off the accessory, disconnect it, then install the auxiliary DC jack cap.

EWA14361

⚠ WARNING

To prevent electrical shock or short-circuiting, make sure that the cap is installed when the auxiliary DC jack is not being used.

Auxiliary DC connectors

This vehicle is equipped with an auxiliary DC connector, a grip warmer DC connector and a fog lamps connector. Consult a Yamaha dealer before installing any accessories.

Sidestand

EAU15306

The sidestand is located on the left side of the frame. Raise the sidestand or lower it with your foot while holding the vehicle upright.

TIP

The built-in sidestand switch is part of the ignition circuit cut-off system, which cuts the ignition in certain situations. (See the following section for an explanation of the ignition circuit cut-off system.)

EWA10242

⚠ WARNING

The vehicle must not be ridden with the sidestand down, or if the sidestand cannot be properly moved up (or does not stay up), otherwise the sidestand could contact the ground and distract the operator, resulting in a possible loss of control. Yamaha's ignition circuit cut-off system has been designed to assist the operator in fulfilling the responsibility of raising the sidestand before starting off. Therefore, check

this system regularly and have a Yamaha dealer repair it if it does not function properly.

EAU44895

Ignition circuit cut-off system

This system prevents in-gear engine starts unless the clutch lever is pulled and the sidestand is up. Also, it will stop the running engine should the sidestand be lowered while the transmission is in gear.

Periodically check the system via the following procedure.

TIP

- This check is most reliable if performed with a warmed-up engine.
 - See pages 3-2 and 3-12 for switch operation information.
-

Instrument and control functions

3

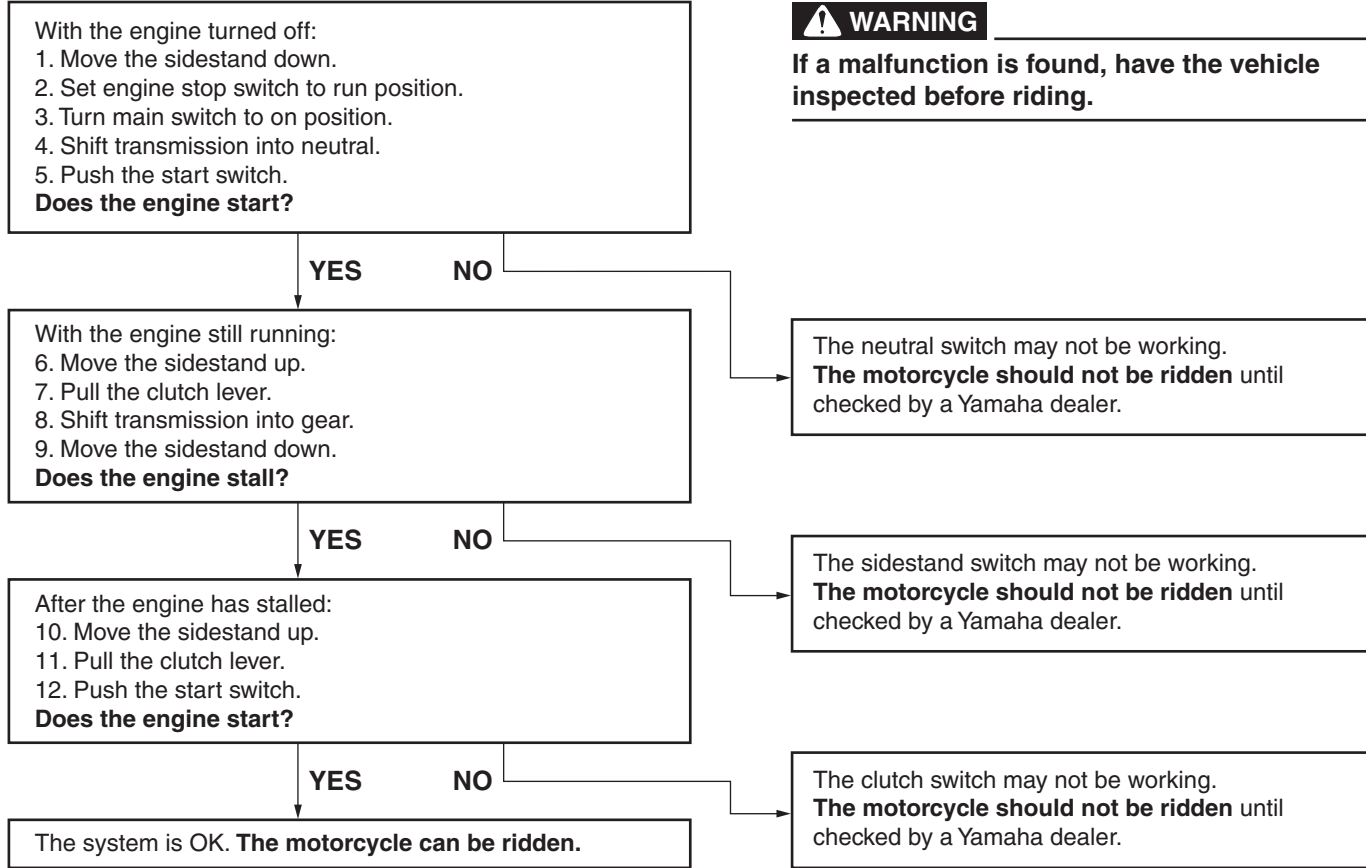

WARNING
If a malfunction is found, have the vehicle inspected before riding.

The neutral switch may not be working.
The motorcycle should not be ridden until checked by a Yamaha dealer.

The sidestand switch may not be working.
The motorcycle should not be ridden until checked by a Yamaha dealer.

The clutch switch may not be working.
The motorcycle should not be ridden until checked by a Yamaha dealer.

For your safety – pre-operation checks

EAU15599

Inspect your vehicle each time you use it to make sure the vehicle is in safe operating condition. Always follow the inspection and maintenance procedures and schedules described in the Owner's Manual.

EWA11152

WARNING

Failure to inspect or maintain the vehicle properly increases the possibility of an accident or equipment damage. Do not operate the vehicle if you find any problem. If a problem cannot be corrected by the procedures provided in this manual, have the vehicle inspected by a Yamaha dealer.

4

Before using this vehicle, check the following points:

ITEM	CHECKS	PAGE
Fuel	<ul style="list-style-type: none">• Check fuel level in fuel tank.• Refuel if necessary.• Check fuel line for leakage.• Check fuel tank breather/overflow hose for obstructions, cracks or damage, and check hose connection.	3-17, 3-19
Engine oil	<ul style="list-style-type: none">• Check oil level in engine.• If necessary, add recommended oil to specified level.• Check vehicle for oil leakage.	6-11
Coolant	<ul style="list-style-type: none">• Check coolant level in reservoir.• If necessary, add recommended coolant to specified level.• Check cooling system for leakage.	6-14
Front brake	<ul style="list-style-type: none">• Check operation.• If soft or spongy, have Yamaha dealer bleed hydraulic system.• Check brake pads for wear.• Replace if necessary.• Check fluid level in reservoir.• If necessary, add specified brake fluid to specified level.• Check hydraulic system for leakage.	6-21, 6-22

For your safety – pre-operation checks

ITEM	CHECKS	PAGE
Rear brake	<ul style="list-style-type: none"> • Check operation. • If soft or spongy, have Yamaha dealer bleed hydraulic system. • Check brake pads for wear. • Replace if necessary. • Check fluid level in reservoir. • If necessary, add specified brake fluid to specified level. • Check hydraulic system for leakage. 	6-21, 6-22
Clutch	<ul style="list-style-type: none"> • Check operation. • Lubricate cable if necessary. • Check lever free play. • Adjust if necessary. 	6-19
Throttle grip	<ul style="list-style-type: none"> • Make sure that operation is smooth. • Check throttle grip free play. • If necessary, have Yamaha dealer adjust throttle grip free play and lubricate cable and grip housing. 	6-17, 6-26
Control cables	<ul style="list-style-type: none"> • Make sure that operation is smooth. • Lubricate if necessary. 	6-26
Drive chain	<ul style="list-style-type: none"> • Check chain slack. • Adjust if necessary. • Check chain condition. • Lubricate if necessary. 	6-23, 6-25
Wheels and tires	<ul style="list-style-type: none"> • Check for damage. • Check tire condition and tread depth. • Check air pressure. • Correct if necessary. 	6-17, 6-19
Brake and shift pedals	<ul style="list-style-type: none"> • Make sure that operation is smooth. • Lubricate pedal pivoting points if necessary. 	6-26
Brake and clutch levers	<ul style="list-style-type: none"> • Make sure that operation is smooth. • Lubricate lever pivoting points if necessary. 	6-27
Sidestand	<ul style="list-style-type: none"> • Make sure that operation is smooth. • Lubricate pivot if necessary. 	6-28

For your safety – pre-operation checks

ITEM	CHECKS	PAGE
Chassis fasteners	<ul style="list-style-type: none">• Make sure that all nuts, bolts and screws are properly tightened.• Tighten if necessary.	—
Instruments, lights, signals and switches	<ul style="list-style-type: none">• Check operation.• Correct if necessary.	—
Sidestand switch	<ul style="list-style-type: none">• Check operation of ignition circuit cut-off system.• If system is not working correctly, have Yamaha dealer check vehicle.	3-27

Operation and important riding points

EAU15952

Read the Owner's Manual carefully to become familiar with all controls. If there is a control or function you do not understand, ask your Yamaha dealer.

EWA10272

WARNING

Failure to familiarize yourself with the controls can lead to loss of control, which could cause an accident or injury.

5

EAU16842

Engine break-in

There is never a more important period in the life of your engine than the period between 0 and 1600 km (1000 mi). For this reason, you should read the following material carefully.

Since the engine is brand new, do not put an excessive load on it for the first 1600 km (1000 mi). The various parts in the engine wear and polish themselves to the correct operating clearances. During this period, prolonged full-throttle operation or any condition that might result in engine overheating must be avoided.

EAU17094

0–1000 km (0–600 mi)

Avoid prolonged operation above 5000 r/min. **NOTICE: After 1000 km (600 mi) of operation, the engine oil must be changed and the oil filter cartridge or element replaced.** [ECA10303]

1000–1600 km (600–1000 mi)

Avoid prolonged operation above 6000 r/min.

1600 km (1000 mi) and beyond

The vehicle can now be operated normally.

ECA10311

NOTICE

- **Keep the engine speed out of the tachometer red zone.**
 - **If any engine trouble should occur during the engine break-in period, immediately have a Yamaha dealer check the vehicle.**
-

Starting the engine

EAU86620

The ignition circuit cut-off system will enable starting when:

- the transmission is in the neutral position or
- the transmission is in gear, the sidestand is up, and the clutch lever is pulled.

To start the engine

1. Turn the main switch on and set the engine stop switch to the run position.
2. Confirm the indicator and warning light(s) come on for a few seconds, and the go off. (See page 3-3.)

TIP _____

- Do not start the engine if the engine trouble warning light remains on.
- The oil pressure warning light should come on and stay on until the engine is started.

- The ABS warning light should come on and stay on until the vehicle reaches a speed of 10 km/h (6 mi/h).

ECA24110

NOTICE _____

If a warning or indicator light does not work as described above, have a Yamaha dealer check the vehicle.

3. Shift the transmission into the neutral position.
4. Start the engine by pushing the start switch.
5. Release the start switch when the engine starts, or after 5 seconds. Wait 10 seconds before pressing the switch again to allow battery voltage to restore.

ECA11043

NOTICE _____

For maximum engine life, never accelerate hard when the engine is cold!

EAUM3632

TIP _____

This model is equipped with:

- a lean angle sensor. This sensor stops the engine in case of a vehicle turnover. If this happens, the engine trouble warning light will come on, but this is not a malfunction. Turn the vehicle power off and then back on again to cancel the warning light. Failing to do so will prevent the engine from starting even though the engine will crank when pushing the start switch.
- an engine auto-stop system. The engine stops automatically if left idling for 20 minutes. If the engine stops, simply push the start switch to restart the engine.

Operation and important riding points

Shifting

EAU16674

ECA10261

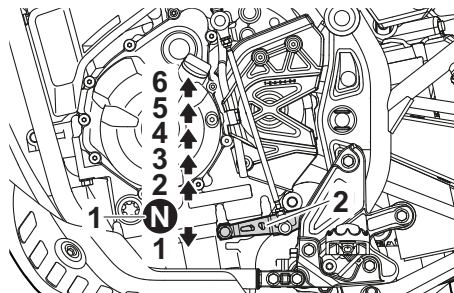

1. Gear positions
2. Shift pedal

Shifting gears lets you control the amount of engine power available for starting off, accelerating, climbing hills, etc.

The gear positions are shown in the illustration.

TIP

To shift the transmission into the neutral position (N), press the shift pedal down repeatedly until it reaches the end of its travel, and then slightly raise it.

NOTICE

- **Even with the transmission in the neutral position, do not coast for long periods of time with the engine off, and do not tow the motorcycle for long distances. The transmission is properly lubricated only when the engine is running. Inadequate lubrication may damage the transmission.**

- **Always use the clutch while changing gears to avoid damaging the engine, transmission, and drive train, which are not designed to withstand the shock of forced shifting.**

EAU85370

To start out and accelerate

1. Pull the clutch lever to disengage the clutch.
2. Shift the transmission into first gear. The neutral indicator light should go out.
3. Open the throttle gradually, and at the same time, release the clutch lever slowly.

4. After starting out, close the throttle, and at the same time, quickly pull the clutch lever in.
5. Shift the transmission into second gear. (Make sure not to shift the transmission into the neutral position.)
6. Open the throttle part way and gradually release the clutch lever.
7. Follow the same procedure when shifting to the next higher gear.

To decelerate

EAU85380

1. Release the throttle and apply both the front and the rear brakes smoothly to slow the motorcycle.
2. As the vehicle decelerates, shift to a lower gear.
3. When the engine is about to stall or runs roughly, pull the clutch lever in, use the brakes to slow the motorcycle, and continue to downshift as necessary.
4. Once the motorcycle has stopped, the transmission can be shifted into the neutral position.

The neutral indicator light should come on and then the clutch lever can be released.

EWA17380

WARNING

- **Improper braking can cause loss of control or traction. Always use both brakes and apply them smoothly.**
- **Make sure that the motorcycle and the engine have sufficiently slowed before shifting to a lower gear. Engaging a lower gear when the vehicle or engine speed is too high could make the rear wheel lose traction or the engine to over-rev. This could cause loss of control, an accident and injury. It could also cause engine or drive train damage.**

Tips for reducing fuel consumption

EAU16811

Fuel consumption depends largely on your riding style. Consider the following tips to reduce fuel consumption:

- Shift up swiftly, and avoid high engine speeds during acceleration.
- Do not rev the engine while shifting down, and avoid high engine speeds with no load on the engine.
- Turn the engine off instead of letting it idle for an extended length of time (e.g., in traffic jams, at traffic lights or at railroad crossings).

Parking

When parking, stop the engine, and then remove the key from the main switch.

EAU17214

WARNING

- **Since the engine and exhaust system can become very hot, park in a place where pedestrians or children are not likely to touch them and be burned.**
- **Do not park on a slope or on soft ground, otherwise the vehicle may overturn, increasing the risk of a fuel leak and fire.**
- **Do not park near grass or other flammable materials which might catch fire.**

EWA10312

Periodic maintenance and adjustment

EAU17246

EWA15123

EAU17303

Periodic inspection, adjustment, and lubrication will keep your vehicle in the safest and most efficient condition possible. Safety is an obligation of the vehicle owner/operator. The most important points of vehicle inspection, adjustment, and lubrication are explained on the following pages.

The intervals given in the periodic maintenance charts should be simply considered as a general guide under normal riding conditions. However, depending on the weather, terrain, geographical location, and individual use, the maintenance intervals may need to be shortened.

WARNING

EWA10322

Failure to properly maintain the vehicle or performing maintenance activities incorrectly may increase your risk of injury or death during service or while using the vehicle. If you are not familiar with vehicle service, have a Yamaha dealer perform service.

WARNING

Turn off the engine when performing maintenance unless otherwise specified.

- **A running engine has moving parts that can catch on body parts or clothing and electrical parts that can cause shocks or fires.**
 - **Running the engine while servicing can lead to eye injury, burns, fire, or carbon monoxide poisoning – possibly leading to death. See page 1-2 for more information about carbon monoxide.**
-

WARNING

EWA15461

Brake discs, calipers, drums, and linings can become very hot during use. To avoid possible burns, let brake components cool before touching them.

Emission controls not only function to ensure cleaner air, but are also vital to proper engine operation and maximum performance. In the following periodic maintenance charts, the services related to emissions control are grouped separately. These services require specialized data, knowledge, and equipment. Maintenance, replacement, or repair of the emission control devices and systems may be performed by any repair establishment or individual that is certified (if applicable). Yamaha dealers are trained and equipped to perform these particular services.

Tool kit

EAUM4190

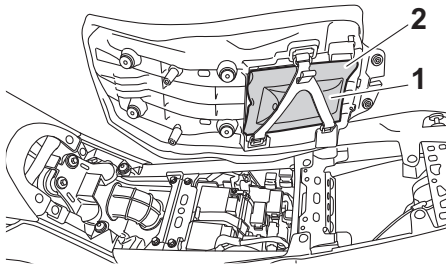

1. Tool kit
2. Storage pouch

The tool kit is in the location shown. Always be sure to install the pouch in the seat base compartment, then the tool kit and secure it with the band.

The information included in this manual and the tools provided in the tool kit are intended to assist you in the performance of preventive maintenance and minor repairs. However, a torque wrench and other tools are necessary to perform certain maintenance work correctly.

TIP

If you do not have the tools or experience required for a particular job, have your Yamaha dealer perform it for you.

Periodic maintenance and adjustment

EAU71033

Periodic maintenance charts

TIP

- Items marked with an asterisk should be performed by your Yamaha dealer because these items require special tools, data, and technical skills.
- From 50000 km (30000 mi), repeat the maintenance intervals starting from 10000 km (6000 mi).
- **The annual checks must be performed every year, except if a distance-based maintenance is performed instead.**

EAU71051

Periodic maintenance chart for the emission control system

NO.	ITEM	CHECK OR MAINTENANCE JOB	ODOMETER READING					ANNUAL CHECK
			1000 km (600 mi)	10000 km (6000 mi)	20000 km (12000 mi)	30000 km (18000 mi)	40000 km (24000 mi)	
1	* Fuel line	<ul style="list-style-type: none"> • Check fuel hoses for cracks or damage. • Replace if necessary. 		√	√	√	√	√
2	* Spark plugs	<ul style="list-style-type: none"> • Check condition. • Adjust gap and clean. 		√		√		
		<ul style="list-style-type: none"> • Replace. 			√		√	
3	* Valve clearance	<ul style="list-style-type: none"> • Check and adjust. 	Every 40000 km (24000 mi)					
4	* Fuel injection	<ul style="list-style-type: none"> • Check engine idle speed. 	√	√	√	√	√	√
		<ul style="list-style-type: none"> • Check and adjust synchronization. 		√	√	√	√	√
5	* Exhaust system	<ul style="list-style-type: none"> • Check for leakage. • Tighten if necessary. • Replace gaskets if necessary. 	√	√	√	√	√	

Periodic maintenance and adjustment

NO.	ITEM	CHECK OR MAINTENANCE JOB	ODOMETER READING					ANNUAL CHECK
			1000 km (600 mi)	10000 km (6000 mi)	20000 km (12000 mi)	30000 km (18000 mi)	40000 km (24000 mi)	
6	*	Evaporative emission control system			√		√	

Periodic maintenance and adjustment

EAU71352

General maintenance and lubrication chart

NO.	ITEM	CHECK OR MAINTENANCE JOB	ODOMETER READING					ANNUAL CHECK
			1000 km (600 mi)	10000 km (6000 mi)	20000 km (12000 mi)	30000 km (18000 mi)	40000 km (24000 mi)	
1	* Diagnostic system check	<ul style="list-style-type: none"> Perform dynamic inspection using Yamaha diagnostic tool. Check the error codes. 	√	√	√	√	√	√
2	* Air filter element	<ul style="list-style-type: none"> Replace. 			√		√	
3	Air filter case check hose	<ul style="list-style-type: none"> Clean. 	√	√	√	√	√	
4	Clutch	<ul style="list-style-type: none"> Check operation. Adjust. 	√	√	√	√	√	
5	* Front brake	<ul style="list-style-type: none"> Check operation, fluid level, and for fluid leakage. Replace brake pads if necessary. 	√	√	√	√	√	√
6	* Rear brake	<ul style="list-style-type: none"> Check operation, fluid level, and for fluid leakage. Replace brake pads if necessary. 	√	√	√	√	√	√
7	* Brake hoses	<ul style="list-style-type: none"> Check for cracks or damage. 		√	√	√	√	√
		<ul style="list-style-type: none"> Replace. 	Every 4 years					
8	* Brake fluid	<ul style="list-style-type: none"> Change. 	Every 2 years					
9	* Wheels	<ul style="list-style-type: none"> Check runout, spoke tightness and for damage. Tighten spokes if necessary. 	√	√	√	√	√	
10	* Tires	<ul style="list-style-type: none"> Check tread depth and for damage. Replace if necessary. Check air pressure. Correct if necessary. 		√	√	√	√	√

Periodic maintenance and adjustment

NO.	ITEM	CHECK OR MAINTENANCE JOB	ODOMETER READING					ANNUAL CHECK
			1000 km (600 mi)	10000 km (6000 mi)	20000 km (12000 mi)	30000 km (18000 mi)	40000 km (24000 mi)	
11	* Wheel bearings	<ul style="list-style-type: none"> • Check bearing for looseness or damage. 		√	√	√	√	
12	* Swingarm pivot bearings	<ul style="list-style-type: none"> • Check operation and for excessive play. 		√	√	√	√	
		<ul style="list-style-type: none"> • Lubricate with lithium-soap-based grease. 	Every 50000 km (30000 mi)					
13	Drive chain	<ul style="list-style-type: none"> • Check chain slack, alignment and condition. • Adjust and lubricate chain with a special O-ring chain lubricant thoroughly. 	Every 1000 km (600 mi) and after washing the motorcycle, riding in the rain or riding in wet areas					
14	* Steering bearings	<ul style="list-style-type: none"> • Check bearing assemblies for looseness. 	√	√		√		
		<ul style="list-style-type: none"> • Moderately repack with lithium-soap-based grease. 			√		√	
15	* Chassis fasteners	<ul style="list-style-type: none"> • Make sure that all nuts, bolts and screws are properly tightened. 		√	√	√	√	√
16	Brake lever pivot shaft	<ul style="list-style-type: none"> • Lubricate with silicone grease. 		√	√	√	√	√
17	Brake pedal pivot shaft	<ul style="list-style-type: none"> • Lubricate with lithium-soap-based grease. 		√	√	√	√	√
18	Clutch lever pivot shaft	<ul style="list-style-type: none"> • Lubricate with lithium-soap-based grease. 		√	√	√	√	√
19	Shift pedal pivot shaft	<ul style="list-style-type: none"> • Lubricate with lithium-soap-based grease. 		√	√	√	√	√

Periodic maintenance and adjustment

NO.	ITEM	CHECK OR MAINTENANCE JOB	ODOMETER READING					ANNUAL CHECK
			1000 km (600 mi)	10000 km (6000 mi)	20000 km (12000 mi)	30000 km (18000 mi)	40000 km (24000 mi)	
20	Sidestand	<ul style="list-style-type: none"> • Check operation. • Lubricate with lithium-soap-based grease. 		√	√	√	√	√
21	* Sidestand switch	<ul style="list-style-type: none"> • Check operation and replace if necessary. 	√	√	√	√	√	√
22	* Front fork	<ul style="list-style-type: none"> • Check operation and for oil leakage. • Replace if necessary. 		√	√	√	√	
23	* Shock absorber assembly	<ul style="list-style-type: none"> • Check operation and for oil leakage. • Replace if necessary. 		√	√	√	√	
24	* Rear suspension relay arm and connecting arm pivoting points	<ul style="list-style-type: none"> • Check operation. 		√	√	√	√	
25	Engine oil	<ul style="list-style-type: none"> • Change (warm engine before draining). • Check oil level and vehicle for oil leakage. 	√	√	√	√	√	√
26	Engine oil filter cartridge	<ul style="list-style-type: none"> • Replace. 	√		√		√	
27	* Cooling system	<ul style="list-style-type: none"> • Check coolant level and vehicle for coolant leakage. 		√	√	√	√	√
		<ul style="list-style-type: none"> • Change. 	Every 3 years					
28	* Front and rear brake switches	<ul style="list-style-type: none"> • Check operation. 	√	√	√	√	√	√
29	* Moving parts and cables	<ul style="list-style-type: none"> • Lubricate. 		√	√	√	√	√

Periodic maintenance and adjustment

NO.	ITEM	CHECK OR MAINTENANCE JOB	ODOMETER READING					ANNUAL CHECK
			1000 km (600 mi)	10000 km (6000 mi)	20000 km (12000 mi)	30000 km (18000 mi)	40000 km (24000 mi)	
30	* Throttle grip housing and cable	<ul style="list-style-type: none"> • Check operation and free play. • Adjust the throttle cable free play if necessary. • Lubricate the throttle grip housing and cable. 		√	√	√	√	√
31	* Lights, signals and switches	<ul style="list-style-type: none"> • Check operation. • Adjust headlight beam. 	√	√	√	√	√	√

EAUM4140

TIP

- Air filter
 - This model's air filter is equipped with a disposable oil-coated paper element, which must not be cleaned with compressed air to avoid damaging it.
 - The air filter element needs to be replaced more frequently when riding in unusually wet or dusty areas.
- Hydraulic brake service
 - Regularly check and, if necessary, correct the brake fluid level.
 - Every two years replace the internal components of the brake master cylinders and change the brake fluid.
 - Replace the brake hoses every four years, or sooner if cracked or damaged.

Periodic maintenance and adjustment

Removing and installing cowlings

EAU18782

The cowlings shown need to be removed to perform some of the maintenance jobs described in this chapter. Refer to this section each time a cowling needs to be removed and installed.

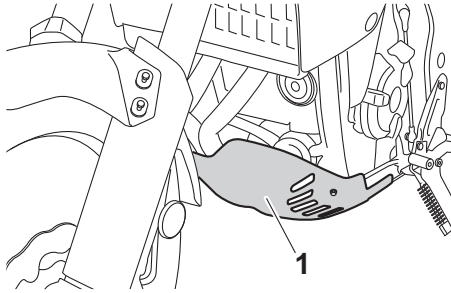

1. Cowling A

Cowling A

EAU18792

To remove the cowling

Remove the screws, and then take the cowling off.

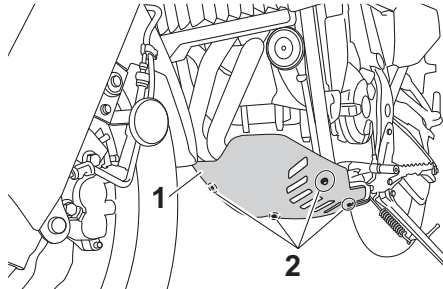

1. Cowling A
2. Screw

To install the cowling

Place the cowling in the original position, and then install the screws.

Checking the spark plugs

EAU19653

The spark plugs are important engine components, which should be checked periodically, preferably by a Yamaha dealer. Since heat and deposits will cause any spark plug to slowly erode, they should be removed and checked in accordance with the periodic maintenance and lubrication chart. In addition, the condition of the spark plugs can reveal the condition of the engine.

The porcelain insulator around the center electrode of each spark plug should be a medium-to-light tan (the ideal color when the vehicle is ridden normally), and all spark plugs installed in the engine should have the same color. If any spark plug shows a distinctly different color, the engine could be operating improperly. Do not attempt to diagnose such problems yourself. Instead, have a Yamaha dealer check the vehicle.

If a spark plug shows signs of electrode erosion and excessive carbon or other deposits, it should be replaced.

Specified spark plug:
NGK/LMAR8A-9

Before installing a spark plug, the spark plug gap should be measured with a wire thickness gauge and, if necessary, adjusted to specification.

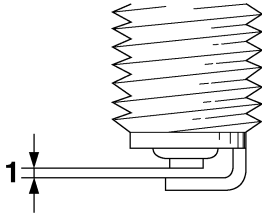

1. Spark plug gap

Spark plug gap:
0.8–0.9 mm (0.031–0.035 in)

Clean the surface of the spark plug gasket and its mating surface, and then wipe off any grime from the spark plug threads.

Tightening torque:
Spark plug:
13 N·m (1.3 kgf·m, 9.6 lb·ft)

TIP

If a torque wrench is not available when installing a spark plug, a good estimate of the correct torque is 1/4–1/2 turn past finger tight. However, the spark plug should be tightened to the specified torque as soon as possible.

ECA10841

NOTICE

Do not use any tools to remove or install the spark plug cap, otherwise the ignition coil coupler may get damaged. The spark plug cap may be difficult to remove because the rubber seal on the end of the cap fits tightly. To remove the spark plug cap, simply twist it back and forth while pulling it out; to install it, twist it back and forth while pushing it in.

Canister

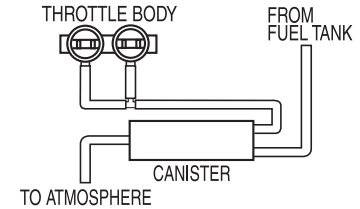

ZAUM1386

This model is equipped with a canister to prevent the discharging of fuel vapor into the atmosphere. Before operating this vehicle, make sure to check the following:

- Check each hose connection.
- Check each hose and canister for cracks or damage. Replace if damaged.
- Make sure that the canister breather is not blocked, and if necessary, clean it.

Periodic maintenance and adjustment

Engine oil and oil filter cartridge

EAUM4151

The engine oil level should be checked before each ride. In addition, the oil must be changed and the oil filter cartridge replaced at the intervals specified in the periodic maintenance chart.

To check the engine oil level

1. Place the vehicle on a level surface and hold it in an upright position. A slight tilt to the side can result in a false reading.
2. Start the engine, warm it up for several minutes, and then turn it off.
3. Wait a few minutes for the oil level to settle for an accurate reading, and then check the oil level through the engine oil level check window.

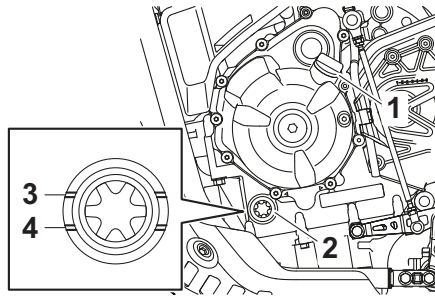

1. Engine oil filler cap
 2. Engine oil level check window
 3. Maximum level mark
 4. Minimum level mark
4. If the engine oil is below the minimum level mark, add sufficient oil of the recommended type to raise it to the maximum level mark.

TIP

Check the O-ring for damage, and replace it if necessary.

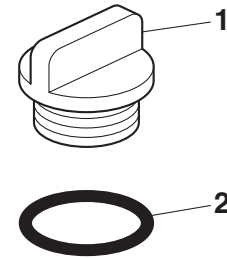

1. Engine oil filler cap
2. O-ring

To change the engine oil (and replace the filter)

1. Place the vehicle on a level surface.
2. Remove cowling A. (See page 6-9.)
3. Start the engine, warm it up for several minutes, and then turn it off.
4. Place an oil pan under the engine to collect the used oil.
5. Remove the engine oil filler cap, the engine oil drain bolt and its gasket to drain the oil from the crankcase.

Periodic maintenance and adjustment

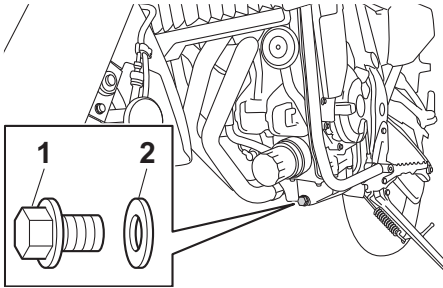

1. Engine oil drain bolt
2. Gasket

TIP
Skip steps 5–7 if the oil filter cartridge is not being replaced.

6. Remove the oil filter cartridge with an oil filter wrench.

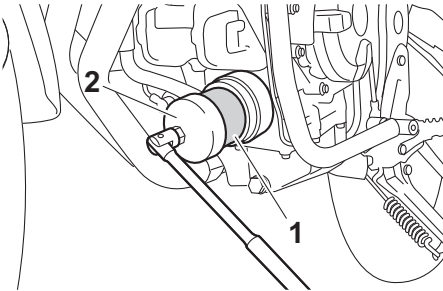

1. Oil filter cartridge
2. Oil filter wrench

TIP
An oil filter wrench is available at a Yamaha dealer.

7. Apply a thin coat of clean engine oil to the O-ring of the new oil filter cartridge.

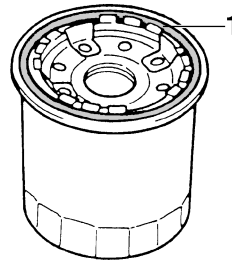

1. O-ring

TIP
Make sure that the O-ring is properly seated.

8. Install the new oil filter cartridge with an oil filter wrench, and then tighten it to the specified torque with a torque wrench.

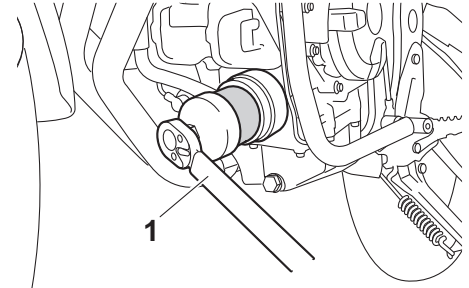

1. Torque wrench

Tightening torque:
Oil filter cartridge:
17 N·m (1.7 kgf·m, 13 lb·ft)

9. Install the engine oil drain bolt and its new gasket, and then tighten the bolt to the specified torque.

Tightening torque:
Engine oil drain bolt:
43 N·m (4.3 kgf·m, 32 lb·ft)

10. Refill with the specified amount of the recommended engine oil.

Periodic maintenance and adjustment

Recommended engine oil:

See page 8-1.

Oil quantity:

Without oil filter cartridge replacement:

2.30 L (2.43 US qt, 2.02 Imp.qt)

With oil filter cartridge replacement:

2.60 L (2.75 US qt, 2.29 Imp.qt)

TIP

Be sure to wipe off spilled oil on any parts after the engine and exhaust system have cooled down.

ECA11621

NOTICE

- In order to prevent clutch slippage (since the engine oil also lubricates the clutch), do not mix any chemical additives. Do not use oils with a diesel specification of "CD" or oils of a higher quality than specified. In addition, do not use oils labeled "ENERGY CONSERVING II" or higher.
- Make sure that no foreign material enters the crankcase.

11. Check the O-ring for damage, and replace it if necessary.

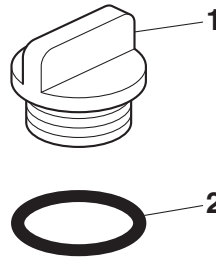

1. Engine oil filler cap
2. O-ring

12. Install and tighten the engine oil filler cap.
13. Install the cowling A.
14. Start the engine, and then let it idle for several minutes while checking it for oil leakage. If oil is leaking, immediately turn the engine off and check for the cause.

TIP

After the engine is started, the engine oil pressure warning light should go off.

ECA20860

NOTICE

If the oil pressure warning light flickers or remains on even if the oil level is correct, immediately turn the engine off and have a Yamaha dealer check the vehicle.

15. Turn the engine off, wait a few minutes for the oil level to settle for an accurate reading, and then check the oil level and correct it if necessary.

Why Yamalube

EAU85450

YAMALUBE oil is a Genuine YAMAHA Part born of the engineers' passion and belief that engine oil is an important liquid engine component. We form teams of specialists in the fields of mechanical engineering, chemistry, electronics and track testing, and have them develop the engine together with the oil it will use. Yamalube oils take full advantage of the base oil's qualities and blend in the ideal balance of additives to make sure the final oil clears our performance standards. Thus, Yamalube mineral, semisynthetic and synthetic oils have their own distinct characters and value. Yamaha's experience gained over many years of research and development into oil since the 1960's helps make Yamalube the best choice for your Yamaha engine.

YAMALUBE®

Coolant

EAU51203

The coolant level should be checked regularly. In addition, the coolant must be changed at the intervals specified in the periodic maintenance chart.

Recommended coolant:

YAMALUBE coolant

Coolant quantity:

Coolant reservoir (max level mark):
0.25 L (0.26 US qt, 0.22 Imp.qt)
Radiator (including all routes):
1.60 L (1.69 US qt, 1.41 Imp.qt)

TIP

If genuine Yamaha coolant is not available, use an ethylene glycol antifreeze containing corrosion inhibitors for aluminum engines and mix with distilled water at a 1:1 ratio.

EAU20097

To check the coolant level

Since the coolant level varies with engine temperature, check when the engine is cold.

1. Park the vehicle on a level surface.

2. With the vehicle in an upright position, look at the coolant level in the reservoir.

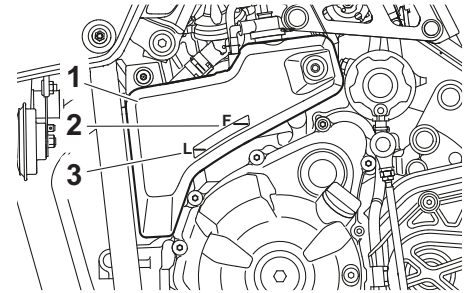

1. Coolant reservoir
2. Maximum level mark
3. Minimum level mark

3. If the coolant is at or below the minimum level mark, remove the coolant reservoir cap. **WARNING! Remove only the coolant reservoir cap. Never attempt to remove the radiator cap when the engine is hot.** [EWA15162]

Periodic maintenance and adjustment

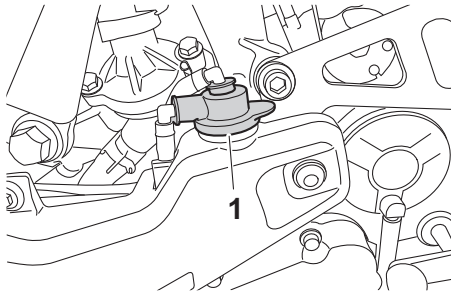

1. Coolant reservoir cap

- 6
4. Add coolant to the maximum level mark. **NOTICE:** If coolant is not available, use distilled water or soft tap water instead. Do not use hard water or salt water since it is harmful to the engine. If water has been used instead of coolant, replace it with coolant as soon as possible, otherwise the cooling system will not be protected against frost and corrosion. If water has been added to the coolant, have a Yamaha dealer check the anti-freeze content of the coolant as soon as possible, otherwise the effectiveness of the coolant will be reduced. [ECA10473]

5. Install the coolant reservoir cap.

Changing the coolant

EAU33032

The coolant must be changed at the intervals specified in the periodic maintenance and lubrication chart. Have a Yamaha dealer change the coolant.

WARNING! Never attempt to remove the radiator cap when the engine is hot. [EWA10382]

Replacing the air filter element and cleaning the check hose

EAU4160

The air filter element must be replaced at the intervals specified in the periodic maintenance chart. Replace the air filter element more frequently if you often ride the rain or dusty areas. In addition, the air filter check hose should be frequently checked and cleaned if necessary.

To replace the air filter element

1. Remove the passenger seat. (See page 3-19.)
2. Remove the rider seat. (See page 3-19.)
3. Remove the air filter case cover by removing the screws, remove the screw securing the air filter element and then pull it out.

Periodic maintenance and adjustment

ECA21220

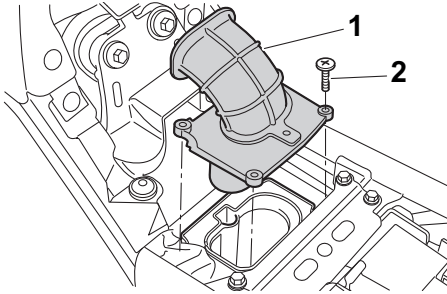

1. Air filter case cover
2. Screw

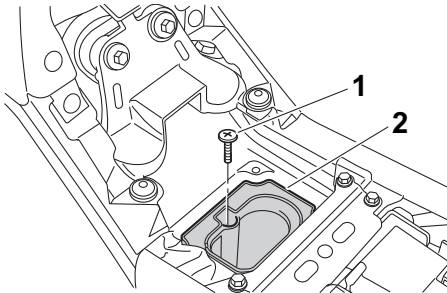

1. Screw
2. Air filter element

4. Check the air filter for damage or dirt and replace it if necessary.

NOTICE

- The air filter element must be replaced at the intervals specified in the periodic maintenance chart.
- The air filter element should be replaced more frequently if often ride in the rain or dusty areas.
- The air filter cannot be cleaned by blowing it with compressed air. It must be replaced.

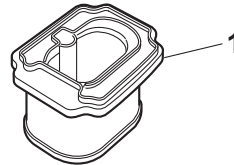

1. Air filter element

5. Insert the air filter element into the air filter case and secure it with the screw. **NOTICE: Make sure that the air filter element is properly**

seated in the air filter case. The engine should never be operated without the air filter element installed, otherwise the piston(s) and/or cylinder(s) may become excessively worn.

[ECA10482]

6. Install the air filter case cover by installing the screws.
7. Install the seats.

To clean the air filter check hose

1. Remove the air filter check hose under the air filter case.

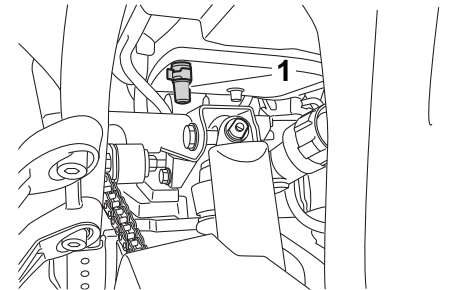

1. Air filter check hose

2. Remove the hose, clean it, and then install it in its original position.

Periodic maintenance and adjustment

Checking the throttle grip free play

EAU21386

Measure the throttle grip free play as shown.

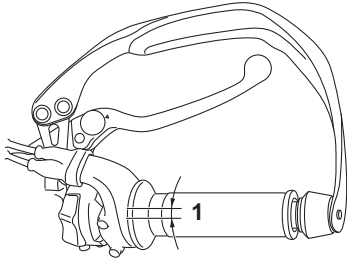

1. Throttle grip free play

Throttle grip free play:
3.0–5.0 mm (0.12–0.20 in)

Periodically check the throttle grip free play and, if necessary, have a Yamaha dealer adjust it.

Valve clearance

EAU21403

The valves are an important engine component, and since valve clearance changes with use, they must be checked and adjusted at the intervals specified in the periodic maintenance chart. Unadjusted valves can result in improper air-fuel mixture, engine noise, and eventually engine damage. To prevent this from occurring, have your Yamaha dealer check and adjust the valve clearance at regular intervals.

TIP

This service must be performed when the engine is cold.

Tires

EAU88380

Tires are the only contact between the vehicle and the road. Safety in all conditions of riding depends on a relatively small area of road contact. Therefore, it is essential to maintain the tires in good condition at all times and replace them at the appropriate time with the specified tires.

Tire air pressure

The tire air pressure should be checked and, if necessary, adjusted before each ride.

EWA10504

WARNING

Operation of this vehicle with improper tire pressure may cause severe injury or death from loss of control.

- The tire air pressure must be checked and adjusted on cold tires (i.e., when the temperature of the tires equals the ambient temperature).
- The tire air pressure must be adjusted in accordance with the riding speed and with the total

Periodic maintenance and adjustment

EWA17960

weight of rider, passenger, cargo, and accessories approved for this model.

Cold tire air pressure:

1 person:

Front:

220 kPa (2.20 kgf/cm², 32 psi)

Rear:

250 kPa (2.50 kgf/cm², 36 psi)

2 persons:

Front:

220 kPa (2.20 kgf/cm², 32 psi)

Rear:

250 kPa (2.50 kgf/cm², 36 psi)

Off-road riding:

Front:

200 kPa (2.00 kgf/cm², 29 psi)

Rear:

200 kPa (2.00 kgf/cm², 29 psi)

Maximum load:

Vehicle:

190 kg (419 lb)

The vehicle's maximum load is the combined weight of the rider, passenger, cargo, and any accessories.

EWA10512



WARNING

Never overload your vehicle. Operation of an overloaded vehicle could cause an accident.

Tire inspection

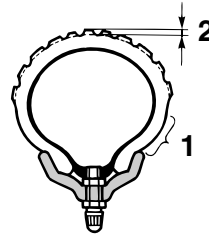

1. Tire sidewall
2. Tire tread depth

The tires must be checked before each ride. If the center tread depth reaches the specified limit, if the tire has a nail or glass fragments in it, or if the sidewall is cracked, have a Yamaha dealer replace the tire immediately.

Minimum tire tread depth (front and rear):
1.6 mm (0.06 in)

TIP

The tire tread depth limits may differ from country to country. Always comply with the local regulations.



WARNING

- It is dangerous to ride with a worn-out tire. When a tire tread depth reaches the specified limit, have a Yamaha dealer replace the tire immediately.
- The replacement of all wheel and brake-related parts, including the tires, should be left to a Yamaha dealer, who has the necessary professional knowledge and experience.
- It is not recommended to patch a punctured tube. If unavoidable, however, patch the tube very carefully and replace it as soon as possible with a high-quality product.
- Ride at moderate speeds after changing a tire since the tire surface must first be “broken in” for it to develop its optimal characteristics.

Tire information

This model is equipped with tube tires.

Periodic maintenance and adjustment

Tires age, even if they have not been used or have only been used occasionally. Cracking of the tread and sidewall rubber, sometimes accompanied by carcass deformation, is an evidence of ageing. Old and aged tires shall be checked by tire specialists to ascertain their suitability for further use.

EWA10462

⚠ WARNING

The front and rear tires should be of the same make and design, otherwise the handling characteristics of the vehicle may be different, which could lead to an accident.

After extensive tests, only the tires listed below have been approved for this model by Yamaha.

Front tire:

Size:

90/90 - 21 M/C 54V M+S

Manufacturer/model:

PIRELLI/SCORPION RALLY STR
A

Rear tire:

Size:

150/70 R18 M/C 70V M+S

Manufacturer/model:

PIRELLI/SCORPION RALLY STR

Spoke wheels

EAU21945

To maximize the performance, durability, and safe operation of the vehicle, note the following points.

- Check each wheel for cracks, deformation and other damage. If any damage is found, have the wheel inspected by your Yamaha dealer. Do not attempt to repair or straighten a bent or damaged wheel.
- Check the spokes for looseness. If any loose spokes are found, have the wheel adjusted by your Yamaha dealer. Improperly tightened spokes can cause wheel misalignment.
- Have the wheel balanced whenever the tire or tube has been replaced. An unbalanced wheel can result in adverse handling characteristics and shortened tire life.

EWA10611

⚠ WARNING

The wheels on this model are not designed for use with tubeless tires. Do not attempt to use tubeless tires on this model.

Adjusting the clutch lever free play

EAU33893

Measure the clutch lever free play as shown.

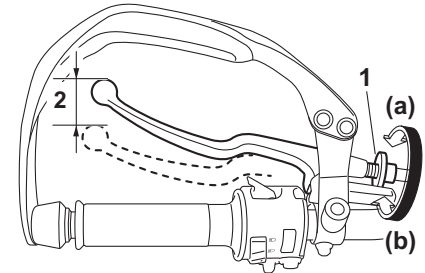

1. Clutch lever free play adjusting bolt
2. Clutch lever free play

Clutch lever free play:

5.0–10.0 mm (0.20–0.39 in)

Periodically check the clutch lever free play and, if necessary, adjust it as follows.

To increase the clutch lever free play, turn the clutch lever free play adjusting bolt at the clutch lever in direction (a). To decrease the clutch lever free play, turn the adjusting bolt in direction (b).

TIP _____
If the specified clutch lever free play cannot be obtained as described above, proceed as follows.

1. Fully turn the adjusting bolt at the clutch lever in direction (a) to loosen the clutch cable.
2. Loosen the locknut at the crankcase.

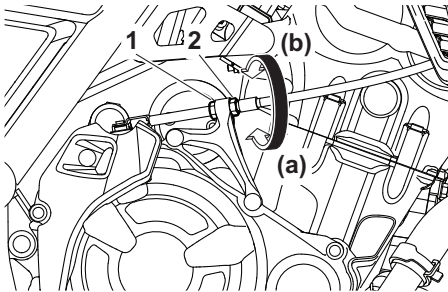

1. Locknut
2. Clutch lever free play adjusting nut
3. To increase the clutch lever free play, turn the clutch lever free play adjusting nut in direction (a). To decrease the clutch lever free play, turn the adjusting nut in direction (b).
4. Tighten the locknut.

Checking the brake lever free play ^{EAU37914}

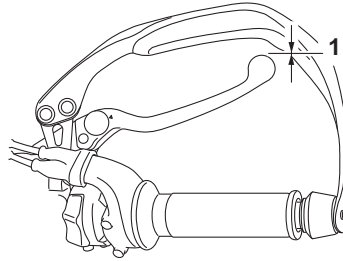

1. No brake lever free play

There should be no free play at the brake lever end. If there is free play, have a Yamaha dealer inspect the brake system.

EWA14212

⚠ WARNING

A soft or spongy feeling in the brake lever can indicate the presence of air in the hydraulic system. If there is air in the hydraulic system, have a Yamaha dealer bleed the system before operating the vehicle. Air in the hydraulic system will diminish the

braking performance, which may result in loss of control and an accident.

Periodic maintenance and adjustment

Brake light switches

EAU36505

The brake light should come on just before braking takes effect. The brake light is activated by switches connected to the brake lever and brake pedal. Since the brake light switches are components of the anti-lock brake system, they should only be serviced by a Yamaha dealer.

Checking the front and rear brake pads

EAU22393

The front and rear brake pads must be checked for wear at the intervals specified in the periodic maintenance and lubrication chart.

Front brake pads

EAU22433

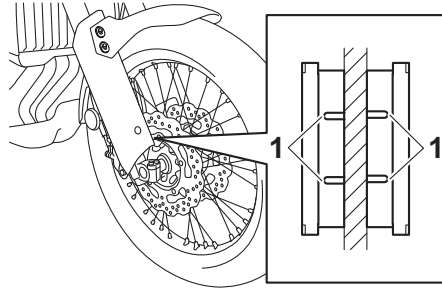

1. Brake pad wear indicator groove

Each front brake pad is provided with wear indicator grooves, which allow you to check the brake pad wear without having to disassemble the brake. To check the brake pad wear, check the wear indicator grooves. If a brake pad has worn to the point that the wear

indicator grooves have almost disappeared, have a Yamaha dealer replace the brake pads as a set.

Rear brake pads

EAU46292

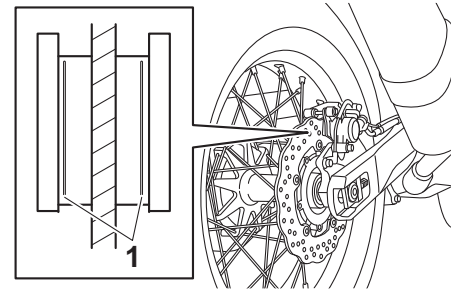

1. Brake pad wear indicator groove

Each rear brake pad is provided with wear indicator grooves, which allow you to check the brake pad wear without having to disassemble the brake. To check the brake pad wear, check the wear indicator grooves. If a brake pad has worn to the point that a wear indicator groove almost appears, have a Yamaha dealer replace the brake pads as a set.

Checking the brake fluid level EAU40262

Before riding, check that the brake fluid is above the minimum level mark. Check the brake fluid level with the top of the reservoir level. Replenish the brake fluid if necessary.

Front brake

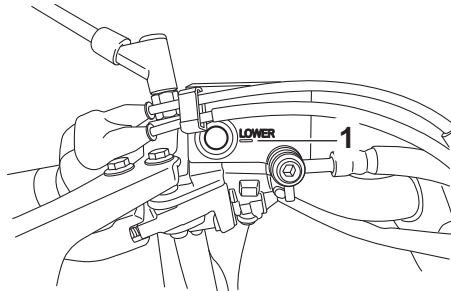

1. Minimum level mark

Rear brake

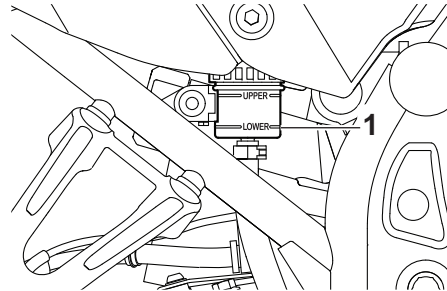

1. Minimum level mark

Specified brake fluid:
DOT 4

EWA16011

! WARNING

Improper maintenance can result in loss of braking ability. Observe these precautions:

- **Insufficient brake fluid may allow air to enter the brake system, reducing braking performance.**
- **Clean the filler cap before removing. Use only DOT 4 brake fluid from a sealed container.**

- **Use only the specified brake fluid; otherwise, the rubber seals may deteriorate, causing leakage.**
- **Refill with the same type of brake fluid. Adding a brake fluid other than DOT 4 may result in a harmful chemical reaction.**
- **Be careful that water or dust does not enter the brake fluid reservoir when refilling. Water will significantly lower the boiling point of the fluid and may result in vapor lock, and dirt may clog the ABS hydraulic unit valves.**

ECA17641

NOTICE

Brake fluid may damage painted surfaces or plastic parts. Always clean up spilled fluid immediately.

As the brake pads wear, it is normal for the brake fluid level to gradually go down. A low brake fluid level may indicate worn brake pads and/or brake system leakage; therefore, be sure to check the brake pads for wear and the brake system for leakage. If the brake

Periodic maintenance and adjustment

fluid level goes down suddenly, have a Yamaha dealer check the cause before further riding.

Changing the brake fluid

EAU22734

Have a Yamaha dealer change the brake fluid every 2 years. In addition, have the seals of the master cylinders and brake calipers, as well as the brake hoses replaced at the intervals listed below or sooner if they are damaged or leaking.

- Brake seals: every 2 years
- Brake hoses: every 4 years

Drive chain slack

EAU22762

The drive chain slack should be checked before each ride and adjusted if necessary.

To check the drive chain slack

EAU60046

1. Place the motorcycle on the side-stand.

TIP

When checking and adjusting the drive chain slack, there should be no weight on the motorcycle.

2. Shift the transmission into the neutral position.
3. Push down on the drive chain under the end of the drive chain guard.
4. Measure distance A between the drive chain guard and the center of the chain as shown.

Periodic maintenance and adjustment

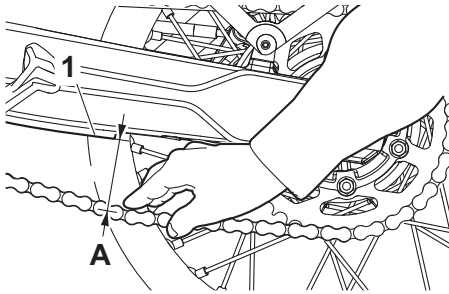

1. Drive chain guide
2. Distance A

Distance A:

43.0–48.0 mm (1.69–1.89 in)

5. If distance A is incorrect, adjust it as follows. **NOTICE: Improper drive chain slack will overload the engine as well as other vital parts of the motorcycle and can lead to chain slippage or breakage. If distance A is more than 55.0 mm (2.16 in), the chain can damage the frame, swingarm, and other parts. To prevent this from occurring, keep the drive chain slack within the specified limits.** [ECA23070]

To adjust the drive chain slack

EAU59921

Consult a Yamaha dealer before adjusting the drive chain slack.

1. Loosen the locknut at each end of the swingarm, and then loosen the axle nut.

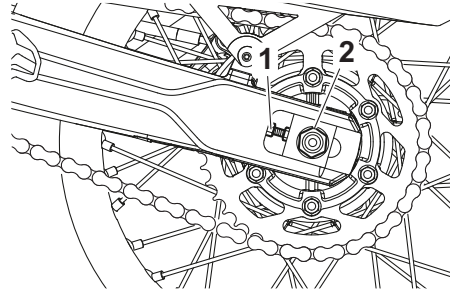

1. Locknut
2. Axle nut

2. To tighten the drive chain, turn the drive chain slack adjusting nut at each end of the swingarm in direction (a). To loosen the drive chain, turn the adjusting nut at each end of the swingarm in direction (b), and then push the rear wheel forward.

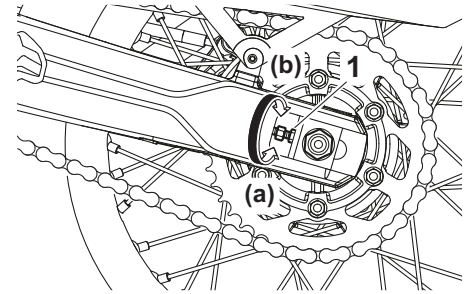

1. Drive chain slack adjusting bolt

TIP

Using the alignment marks on each side of the swingarm, make sure that both drive chain slack adjusting plates are in the same position for proper wheel alignment.

Periodic maintenance and adjustment

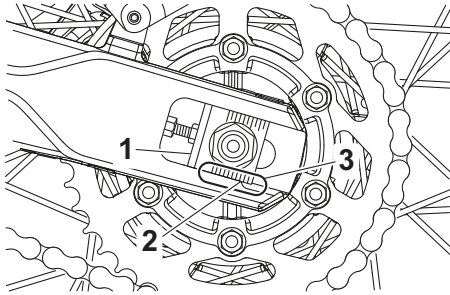

1. Drive chain puller
2. Position indicator
3. Alignment marks

6

3. Tighten the axle nut, and then tighten the locknuts to the specified torques.

Tightening torques:

Axle nut:

105 N·m (10.5 kgf·m, 77 lb·ft)

Locknut:

16 N·m (1.6 kgf·m, 12 lb·ft)

4. Make sure that the drive chain slack adjusting plates are in the same position, the drive chain slack is correct, and the drive chain moves smoothly.

EAU23026

Cleaning and lubricating the drive chain

The drive chain must be cleaned and lubricated at the intervals specified in the periodic maintenance and lubrication chart, otherwise it will quickly wear out, especially when riding in dusty or wet areas. Service the drive chain as follows.

ECA10584

NOTICE

The drive chain must be lubricated after washing the motorcycle, riding in the rain or riding in wet areas.

1. Clean the drive chain with kerosene and a small soft brush. **NOTICE: To prevent damaging the O-rings, do not clean the drive chain with steam cleaners, high-pressure washers or inappropriate solvents.** [ECA11122]
2. Wipe the drive chain dry.
3. Thoroughly lubricate the drive chain with a special O-ring chain lubricant. **NOTICE: Do not use engine oil or any other lubricants for the drive chain, as they**

may contain substances that could damage the O-rings.

[ECA11112]

Checking and lubricating the cables

EAU23098

The operation of all control cables and the condition of the cables should be checked before each ride, and the cables and cable ends should be lubricated if necessary. If a cable is damaged or does not move smoothly, have a Yamaha dealer check or replace it. **WARNING! Damage to the outer housing of cables may result in internal rusting and cause interference with cable movement. Replace damaged cables as soon as possible to prevent unsafe conditions.** [EWA10712]

Recommended lubricant:

Yamaha cable lubricant or other suitable cable lubricant

Checking and lubricating the throttle grip and cable

EAU23115

The operation of the throttle grip should be checked before each ride. In addition, the cable should be lubricated by a Yamaha dealer at the intervals specified in the periodic maintenance chart.

The throttle cable is equipped with a rubber cover. Make sure that the cover is securely installed. Even though the cover is installed correctly, it does not completely protect the cable from water entry. Therefore, use care not to pour water directly onto the cover or cable when washing the vehicle. If the cable or cover becomes dirty, wipe clean with a moist cloth.

Checking and lubricating the brake and shift pedals

EAU44276

The operation of the brake and shift pedals should be checked before each ride, and the pedal pivots should be lubricated if necessary.

Brake pedal

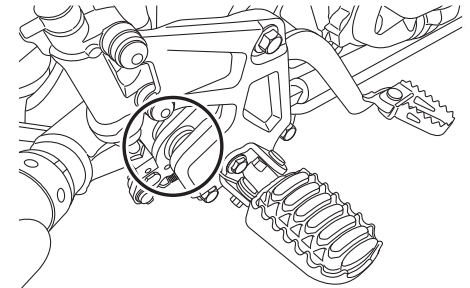

Shift pedal

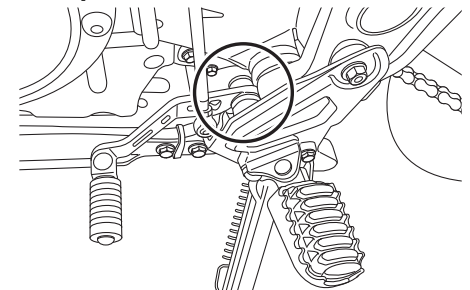

Periodic maintenance and adjustment

Recommended lubricant:
Lithium-soap-based grease

Checking and lubricating the brake and clutch levers

EAU23144

The operation of the brake and clutch levers should be checked before each ride, and the lever pivots should be lubricated if necessary.

Recommended lubricants:

Brake lever:
Silicone grease
Clutch lever:
Lithium-soap-based grease

Brake lever

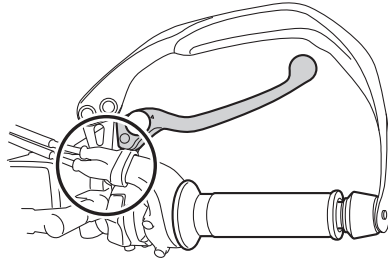

Clutch lever

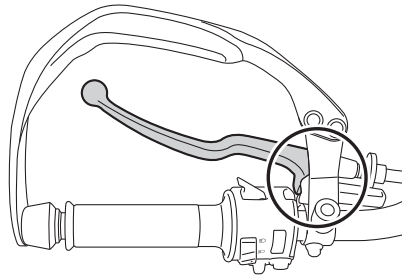

Checking and lubricating the sidestand

EAU23203

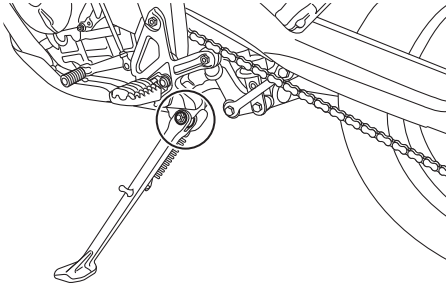

The operation of the sidestand should be checked before each ride, and the sidestand pivot and metal-to-metal contact surfaces should be lubricated if necessary.

EWA10732

WARNING

If the sidestand does not move up and down smoothly, have a Yamaha dealer check or repair it. Otherwise, the sidestand could contact the ground and distract the operator, resulting in a possible loss of control.

Recommended lubricant:
Lithium-soap-based grease

Lubricating the rear suspension

EAU23252

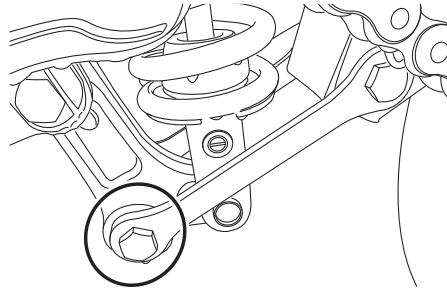

The pivoting points of the rear suspension must be lubricated by a Yamaha dealer at the intervals specified in the periodic maintenance and lubrication chart.

Recommended lubricant:
Lithium-soap-based grease

Lubricating the swingarm pivots

EAUM1653

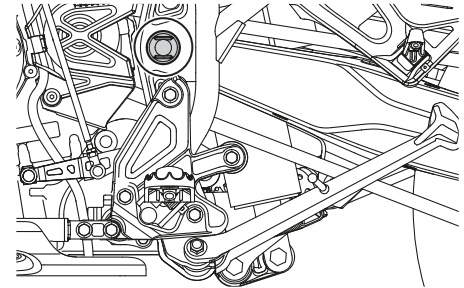

The swingarm pivots must be lubricated by a Yamaha dealer at the intervals specified in the periodic maintenance and lubrication chart.

Recommended lubricant:
Lithium-soap-based grease

Periodic maintenance and adjustment

Checking the front fork

EAU23273

The condition and operation of the front fork must be checked as follows at the intervals specified in the periodic maintenance and lubrication chart.

To check the condition

Check the inner tubes for scratches, damage and excessive oil leakage.

To check the operation

1. Place the vehicle on a level surface and hold it in an upright position. **WARNING! To avoid injury, securely support the vehicle so there is no danger of it falling over.** [EWA10752]
2. While applying the front brake, push down hard on the handlebars several times to check if the front fork compresses and rebounds smoothly.

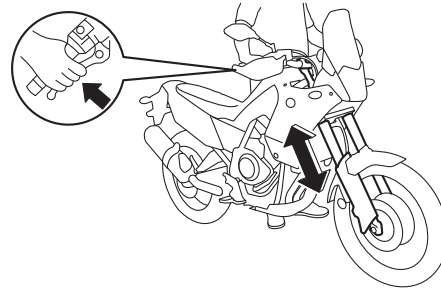

ECA10591

NOTICE

If any damage is found or the front fork does not operate smoothly, have a Yamaha dealer check or repair it.

Checking the steering

EAU23285

Worn or loose steering bearings may cause danger. Therefore, the operation of the steering must be checked as follows at the intervals specified in the periodic maintenance and lubrication chart.

1. Raise the front wheel off the ground. (See page 6-34.) **WARNING! To avoid injury, securely support the vehicle so there is no danger of it falling over.** [EWA10752]
2. Hold the lower ends of the front fork legs and try to move them forward and backward. If any free play can be felt, have a Yamaha dealer check or repair the steering.

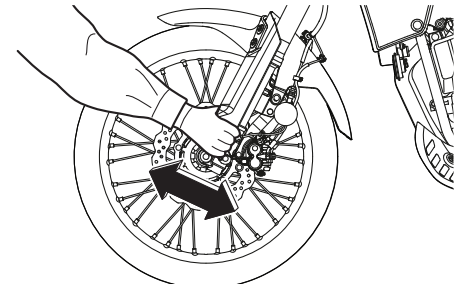

Checking the wheel bearings

EAU23292

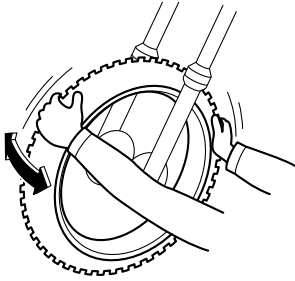

The front and rear wheel bearings must be checked at the intervals specified in the periodic maintenance and lubrication chart. If there is play in the wheel hub or if the wheel does not turn smoothly, have a Yamaha dealer check the wheel bearings.

Battery

EAU50212

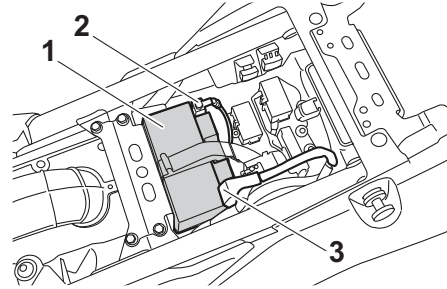

1. Battery
2. Negative battery lead (black)
3. Positive battery lead (red)

The battery is located under the rider seat. (See page 3-19.)

This model is equipped with a VRLA (Valve Regulated Lead Acid) battery. There is no need to check the electrolyte or to add distilled water. However, the battery lead connections need to be checked and, if necessary, tightened.

EWA10761

WARNING

- **Electrolyte is poisonous and dangerous since it contains sulfuric acid, which causes severe**

burns. Avoid any contact with skin, eyes or clothing and always shield your eyes when working near batteries. In case of contact, administer the following **FIRST AID**.

- **EXTERNAL:** Flush with plenty of water.
- **INTERNAL:** Drink large quantities of water or milk and immediately call a physician.
- **EYES:** Flush with water for 15 minutes and seek prompt medical attention.
- **Batteries produce explosive hydrogen gas. Therefore, keep sparks, flames, cigarettes, etc., away from the battery and provide sufficient ventilation when charging it in an enclosed space.**
- **KEEP THIS AND ALL BATTERIES OUT OF THE REACH OF CHILDREN.**

To charge the battery

Have a Yamaha dealer charge the battery as soon as possible if it seems to have discharged. Keep in mind that the

Periodic maintenance and adjustment

battery tends to discharge more quickly if the vehicle is equipped with optional electrical accessories.

ECA16522

NOTICE

To charge a VRLA (Valve Regulated Lead Acid) battery, a special (constant-voltage) battery charger is required. Using a conventional battery charger will damage the battery.

To store the battery

1. If the vehicle will not be used for more than one month, remove the battery, fully charge it, and then place it in a cool, dry place.
NOTICE: When removing the battery, be sure to turn the main switch off, then disconnect the negative lead before disconnecting the positive lead. [ECA16304]
2. If the battery will be stored for more than two months, check it at least once a month and fully charge it if necessary.
3. Fully charge the battery before installation. **NOTICE: When installing the battery, be sure to turn the main switch off, then con-**

nect the positive lead before connecting the negative lead.

[ECA16842]

4. After installation, make sure that the battery leads are properly connected to the battery terminals.

ECA16531

NOTICE

Always keep the battery charged. Storing a discharged battery can cause permanent battery damage.

EAU59872

Replacing the fuses

The main fuse and the fuse boxes, which contain the fuses for the individual circuits, are located under the rider seat. (See page 3-19.)

TIP

To access the main fuse, remove the starter relay cover as shown.

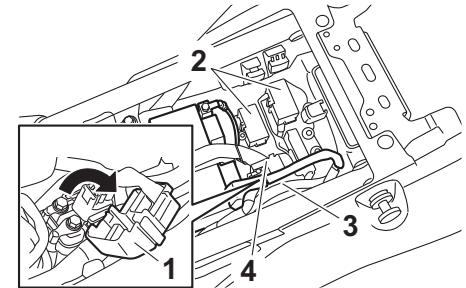

1. Starter relay cover
2. Fuse box
3. Spare main fuse
4. Main fuse

Periodic maintenance and adjustment

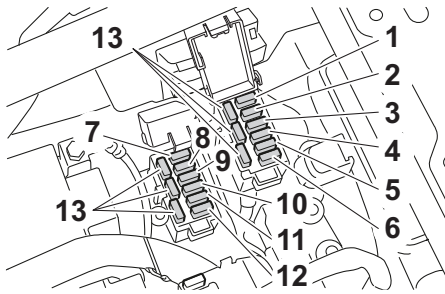

1. ABS solenoid fuse
2. ABS motor fuse
3. Parking lighting fuse
4. Accessory fuse
5. Auxiliary fuse
6. ABS control unit fuse
7. Ignition fuse
8. Signaling system fuse
9. Headlight fuse
10. Fuel injection system fuse
11. Backup fuse (for clock and immobilizer system)
12. Radiator fan motor fuse
13. Spare fuse

If a fuse is blown, replace it as follows.

1. Turn the key to "OFF" and turn off the electrical circuit in question.
2. Remove the blown fuse, and then install a new fuse of the specified amperage. **WARNING! Do not**

use a fuse of a higher amperage rating than recommended to avoid causing extensive damage to the electrical system and possibly a fire. [EWA15132]

Specified fuses:

- Main fuse:
30.0 A
- Auxiliary fuse:
2.0 A
- Headlight fuse:
10.0 A
- Signaling system fuse:
7.5 A
- Ignition fuse:
10.0 A
- Parking lighting fuse:
7.5 A
- Radiator fan motor fuse:
10.0 A
- ABS motor fuse:
30.0 A
- ABS solenoid fuse:
20.0 A
- Fuel injection system fuse:
10.0 A
- ABS control unit fuse:
7.5 A
- Backup fuse:
7.5 A

3. Turn the key to "ON" and turn on the electrical circuit in question to check if the device operates.
4. If the fuse immediately blows again, have a Yamaha dealer check the electrical system.

Periodic maintenance and adjustment

Vehicle lights

EAUN2261

This model is equipped with LED lights for headlights, auxiliary lights and brake/tail light. If a light does not come on, check the fuse and then have a Yamaha dealer check the vehicle.

ECA16581

NOTICE

Do not affix any type of tinted film or stickers to the headlight lens.

Tail/brake light

EAU24182

This model is equipped with an LED-type tail/brake light. If the tail/brake light does not come on, have a Yamaha dealer check it.

Replacing a turn signal light bulb

EAU24205

1. Remove the turn signal light lens by removing the screw.

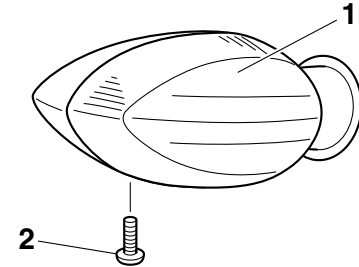

1. Turn signal light lens
2. Screw

2. Remove the burnt-out bulb by pushing it in and turning it counterclockwise.

Periodic maintenance and adjustment

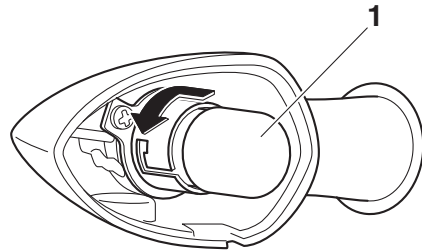

License plate light

EAU24331

If the license plate light does not come on, have a Yamaha dealer check the electrical circuit or replace the bulb.

1. Turn signal light bulb
3. Insert a new bulb into the socket, push it in, and then turn it clockwise until it stops.
4. Install the lens by installing the screw. **NOTICE: Do not over-tighten the screw, otherwise the lens may break.** [ECA11192]

Supporting the motorcycle

EAM4210

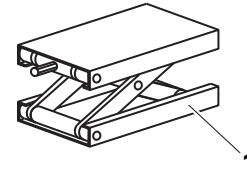

1. Motorcycle jack

Since this model is not equipped with a centerstand, use a motorcycle jack when removing the front or rear wheel or when performing other maintenance that requires the motorcycle to stand upright.

To elevate the vehicle

1. Remove cowling A. (See page 6-9.)
2. If necessary, insert a piece of wood between the motorcycle jack and the engine crankcase. Then lift the vehicle just enough to raise the wheels from the ground. **NOTICE: Do not lift the motorcy-**

Periodic maintenance and adjustment

cle from under the skid plate or by the frame sub-members.

[ECAM1190]

3. Confirm that the vehicle is in a stable and level position before starting any maintenance.

Troubleshooting

EAU25872

Although Yamaha motorcycles receive a thorough inspection before shipment from the factory, trouble may occur during operation. Any problem in the fuel, compression, or ignition systems, for example, can cause poor starting and loss of power.

The following troubleshooting charts represent quick and easy procedures for checking these vital systems yourself. However, should your motorcycle require any repair, take it to a Yamaha dealer, whose skilled technicians have the necessary tools, experience, and know-how to service the motorcycle properly.

Use only genuine Yamaha replacement parts. Imitation parts may look like Yamaha parts, but they are often inferior, have a shorter service life and can lead to expensive repair bills.

EWA15142



When checking the fuel system, do not smoke, and make sure there are no open flames or sparks in the area, including pilot lights from water

heaters or furnaces. Gasoline or gasoline vapors can ignite or explode, causing severe injury or property damage.

Troubleshooting chart

1. Fuel

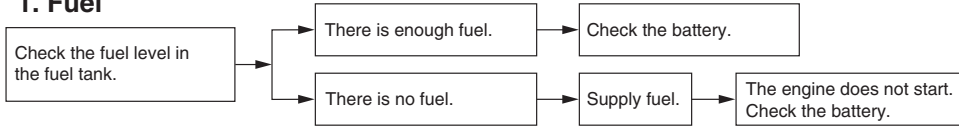

2. Battery

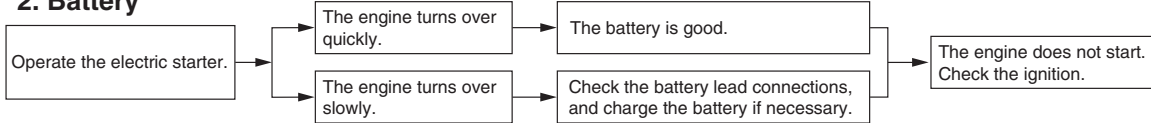

3. Ignition

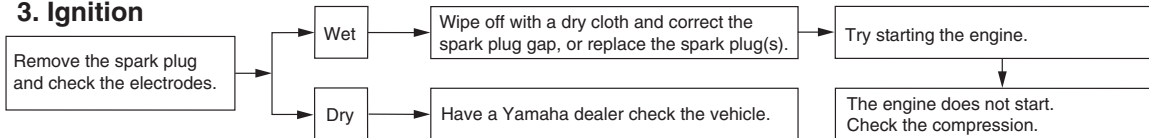

4. Compression

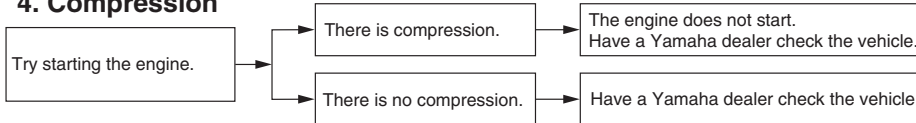

Periodic maintenance and adjustment

EAU86420

Engine overheating

EWAT1041

⚠ WARNING

- Do not remove the radiator cap when the engine and radiator are hot. Scalding hot fluid and steam may be blown out under pressure, which could cause serious injury. Be sure to wait until the engine has cooled.
- Place a thick rag, like a towel, over the radiator cap, and then slowly rotate the cap counterclockwise to the detent to allow any residual pressure to escape. When the hissing sound has stopped, press down on the cap while turning it counterclockwise, and then remove the cap.

6

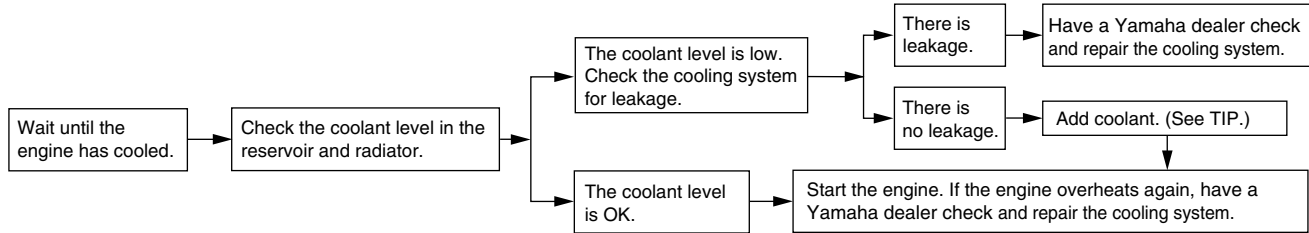

TIP

If coolant is not available, tap water can be temporarily used instead, provided that it is changed to the recommended coolant as soon as possible.

Matte color caution

EAU37834

ECA15193

NOTICE

Some models are equipped with matte colored finished parts. Be sure to consult a Yamaha dealer for advice on what products to use before cleaning the vehicle. Using a brush, harsh chemical products or cleaning compounds when cleaning these parts will scratch or damage their surface. Wax also should not be applied to any matte colored finished parts.

Care

EAU83443

Frequent, thorough cleaning of the vehicle will not only enhance its appearance but also will improve its general performance and extend the useful life of many components. Washing, cleaning, and polishing will also give you a chance to inspect the condition of the vehicle more frequently. Be sure to wash the vehicle after riding in the rain or near the sea, because salt is corrosive to metals.

TIP

- The roads of heavy snowfall areas may be sprayed with salt as a de-icing method. This salt can stay on the roads well into spring, so be sure to wash the underside and chassis parts after riding in such areas.
- Genuine Yamaha care and maintenance products are sold under the YAMALUBE brand in many markets worldwide.
- See your Yamaha dealer for additional cleaning tips.

ECA26280

NOTICE

Improper cleaning can cause cosmetic and mechanical damage. Do not use:

- high-pressure washers or steam-jet cleaners. Excessive water pressure may cause water seepage and deterioration of wheel bearings, brakes, transmission seals and electrical devices. Avoid high-pressure detergent applications such as those available in coin-operated car washers.
- harsh chemicals, including strong acidic wheel cleaners, especially on spoke or magnesium wheels.
- harsh chemicals, abrasive cleaning compounds, or wax on matte-finished parts. Brushes can scratch and damage the matte-finish, use soft sponge or towel only.
- towels, sponges, or brushes contaminated with abrasive cleaning products or strong

Motorcycle care and storage

chemicals such as, solvents, gasoline, rust removers, brake fluid, or antifreeze, etc.

Before washing

1. Park the vehicle out of direct sunlight and allow it to cool. This will help avoid water spots.
2. Make sure all caps, covers, electrical couplers and connectors are tightly installed.
3. Cover the muffler end with a plastic bag and a strong rubber band.
4. Pre-soak stubborn stains like insects or bird droppings with a wet towel for a few minutes.
5. Remove road grime and oil stains with a quality degreasing agent and a plastic-bristle brush or sponge. **NOTICE: Do not use degreasing agent on areas requiring lubrication such as seals, gaskets, and wheel axles. Follow product instructions.**

[ECA26290]

Washing

1. Rinse off any degreaser and spray down the vehicle with a garden hose. Use only enough pressure to do the job. Avoid spraying water directly into the muffler, instrument panel, air inlet, or other inner areas such as underseat storage compartments.
2. Wash the vehicle with a quality automotive-type detergent mixed with cool water and a soft, clean towel or sponge. Use an old toothbrush or plastic-bristle brush for hard-to-reach places. **NOTICE: Use cold water if the vehicle has been exposed to salt. Warm water will increase salt's corrosive properties.** [ECA26301]
3. For windshield-equipped vehicles: Clean the windshield with a soft towel or sponge dampened with water and a pH neutral detergent. If necessary, use a high-quality windshield cleaner or polish for motorcycles. **NOTICE: Never use any strong chemicals to clean the windshield. Additionally, some cleaning compounds for**

plastic may scratch the windshield, so be sure to test all cleaning products before general application. [ECA26310]

4. Rinse off thoroughly with clean water. Be sure to remove all detergent residues, as they can be harmful to plastic parts.

After washing

1. Dry the vehicle with a chamois or absorbent towel, preferably microfiber terrycloth.
2. For drive chain-equipped models: Dry and then lubricate the drive chain to prevent rust.
3. Use a chrome polish to shine chrome, aluminum, and stainless steel parts. Often the thermally induced discoloring of stainless steel exhaust systems can be removed through polishing.
4. Apply a corrosion protection spray on all metal parts including chrome or nickel-plated surfaces. **WARNING! Do not apply silicone or oil spray to seats, hand grips, rubber foot pegs or tire treads. Otherwise these parts**

will become slippery, which could cause loss of control. Thoroughly clean the surfaces of these parts before operating the vehicle. [EWA20650]

5. Treat rubber, vinyl, and unpainted plastic parts with a suitable care product.
6. Touch up minor paint damage caused by stones, etc.
7. Wax all painted surfaces using a non-abrasive wax or use a detail spray for motorcycles.
8. When finished cleaning, start the engine and let it idle for several minutes to help dry any remaining moisture.
9. If the headlight lens has fogged up, start the engine and turn on the headlight to help remove the moisture.
10. Let the vehicle dry completely before storing or covering it.

ECA26320

NOTICE

- Do not apply wax to rubber or unpainted plastic parts.

- Do not use abrasive polishing compounds as they will wear away the paint.
- Apply sprays and wax sparingly. Wipe off excess afterwards.

EWA20660

⚠ WARNING

Contaminants left on the brakes or tires can cause loss of control.

- Make sure there is no lubricant or wax on the brakes or tires.
- If necessary, wash the tires with warm water and a mild detergent.
- If necessary, clean the brake discs and pads with brake cleaner or acetone.
- Before riding at higher speeds, test the vehicle's braking performance and cornering behavior.

Storage

Always store the vehicle in a cool, dry place. If necessary, protect it against dust with a porous cover. Be sure the engine and the exhaust system are cool before covering the vehicle. If the vehicle often sits for weeks at a time between uses, the use of a quality fuel stabilizer is recommended after each fill-up.

ECA21170

NOTICE

- Storing the vehicle in a poorly ventilated room or covering it with a tarp, while it is still wet, will allow water and humidity to seep in and cause rust.
- To prevent corrosion, avoid damp cellars, stables (because of the presence of ammonia) and areas where strong chemicals are stored.

Long term storage

Before storing the vehicle long term (60 days or more):

Motorcycle care and storage

7

1. Make all necessary repairs and perform any outstanding maintenance.
2. Follow all instructions in the Care section of this chapter.
3. Fill up the fuel tank, adding fuel stabilizer according to product instructions. Run the engine for 5 minutes to distribute treated fuel through the fuel system.
4. For vehicles equipped with a fuel cock: Turn the fuel cock lever to the off position.
5. For vehicles with a carburetor: To prevent fuel deposits from building up, drain the fuel in the carburetor float chamber into a clean container. Retighten the drain bolt and pour the fuel back into the fuel tank.
6. Use a quality engine fogging oil according to product instructions to protect internal engine components from corrosion. If engine fogging oil is not available, perform the following steps for each cylinder:
 - a. Remove the spark plug cap and spark plug.
 - b. Pour a teaspoonful of engine oil into the spark plug bore.
 - c. Install the spark plug cap onto the spark plug, and then place the spark plug on the cylinder head so that the electrodes are grounded. (This will limit sparking during the next step.)
 - d. Turn the engine over several times with the starter. (This will coat the cylinder wall with oil.)
WARNING! To prevent damage or injury from sparking, make sure to ground the spark plug electrodes while turning the engine over.
[EWA10952]
 - e. Remove the spark plug cap from the spark plug, and then install the spark plug and the spark plug cap.
7. Lubricate all control cables, pivots, levers and pedals, as well as the sidestand and centerstand (if equipped).
8. Check and correct the tire air pressure, and then lift the vehicle so that all wheels are off the ground. Otherwise, turn the

wheels a little once a month in order to prevent the tires from becoming degraded in one spot.

9. Cover the muffler outlet with a plastic bag to prevent moisture from entering it.
10. Remove the battery and fully charge it, or attach a maintenance charger to keep the battery optimally charged. **NOTICE: Confirm that the battery and its charger are compatible. Do not charge a VRLA battery with a conventional charger.**[ECA26330]

TIP

- If the battery will be removed, charge it once a month and store it in a temperate location between 0-30 °C (32-90 °F).
 - See page 6-30 for more information on charging and storing the battery.
-

Dimensions:

- Overall length:
2370 mm (93.3 in)
- Overall width:
905 mm (35.6 in)
- Overall height:
1455 mm (57.3 in)
- Seat height:
875 mm (34.4 in)
- Wheelbase:
1595 mm (62.8 in)
- Ground clearance:
240 mm (9.45 in)
- Minimum turning radius:
2.8 m (9.47 ft)

Weight:

- Curb weight:
204 kg (450 lb)

Engine:

- Combustion cycle:
4-stroke
- Cooling system:
Liquid cooled
- Valve train:
DOHC
- Cylinder arrangement:
Inline
- Number of cylinders:
2-cylinder
- Displacement:
689 cm³
- Bore × stroke:
80.0 × 68.6 mm (3.15 × 2.70 in)

- Starting system:
Electric starter

Engine oil:

- Recommended brand:



- SAE viscosity grades:
10W-40

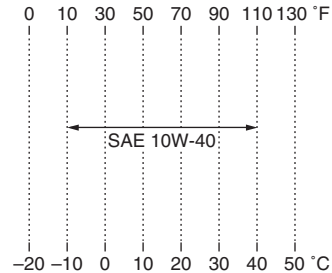

- Recommended engine oil grade:
API service SG type or higher, JASO standard MA

- Engine oil quantity:
Without oil filter cartridge replacement:
2.30 L (2.43 US qt, 2.02 Imp.qt)
With oil filter cartridge replacement:
2.60 L (2.75 US qt, 2.29 Imp.qt)

Coolant quantity:

- Coolant reservoir (up to the maximum level mark):
0.25 L (0.26 US qt, 0.22 Imp.qt)

- Radiator (including all routes):
1.60 L (1.69 US qt, 1.41 Imp.qt)

Fuel:

- Recommended fuel:
Unleaded gasoline (E10 acceptable)
- Octane number (RON):
95
- Fuel tank capacity:
16 L (4.2 US gal, 3.5 Imp.gal)
- Fuel reserve amount:
4.3 L (1.14 US gal, 0.95 Imp.gal)

Fuel injection:

- Throttle body:
ID mark:
1WS1 10

Drivetrain:

- Gear ratio:
1st:
2.846 (37/13)
2nd:
2.125 (34/16)
3rd:
1.632 (31/19)
4th:
1.300 (26/20)
5th:
1.091 (24/22)
6th:
0.964 (27/28)

Front tire:

- Type:
With tube
- Size:
90/90 - 21 M/C 54V M+S

Specifications

Manufacturer/model:

PIRELLI/SCORPION RALLY STR A

Rear tire:

Type:

With tube

Size:

150/70 R18 M/C 70V M+S

Manufacturer/model:

PIRELLI/SCORPION RALLY STR

Loading:

Maximum load:

190 kg (419 lb)

(Total weight of rider, passenger, cargo and accessories)

Front brake:

Type:

Hydraulic dual disc brake

Rear brake:

Type:

Hydraulic single disc brake

Front suspension:

Type:

Telescopic fork

Rear suspension:

Type:

Swingarm (link suspension)

Electrical system:

System voltage:

12 V

Battery:

Model:

YTZ10S

Voltage, capacity:

12 V, 8.6 Ah (10 HR)

Bulb wattage:

Headlight:

LED

Brake/tail light:

LED

Front turn signal light:

10.0 W × 2

Rear turn signal light:

10.0 W × 2

Auxiliary light:

LED

License plate light:

5.0 W × 1

Identification numbers

EAU53562

Record the vehicle identification number, engine serial number, and the model label information in the spaces provided below. These identification numbers are needed when registering the vehicle with the authorities in your area and when ordering spare parts from a Yamaha dealer.

VEHICLE IDENTIFICATION NUMBER:

ENGINE SERIAL NUMBER:

MODEL LABEL INFORMATION:

Vehicle identification number

EAU26401

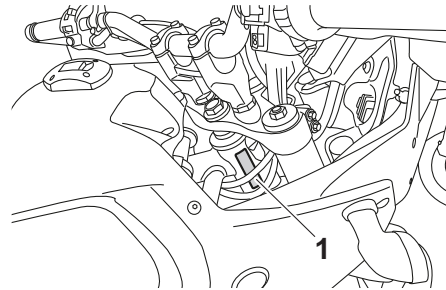

1. Vehicle identification number

The vehicle identification number is stamped into the steering head pipe. Record this number in the space provided.

TIP

The vehicle identification number is used to identify your motorcycle and may be used to register your motorcycle with the licensing authority in your area.

Engine serial number

EAU26442

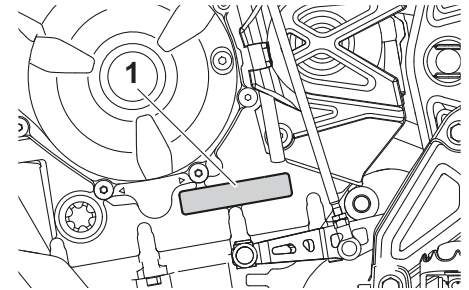

1. Engine serial number

The engine serial number is stamped into the crankcase.

Model label

EAU26521

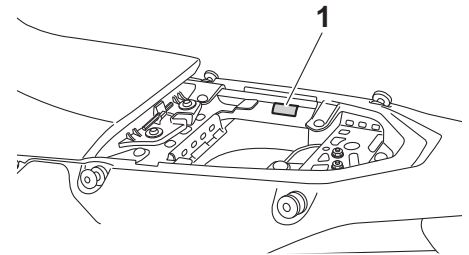

1. Model label

Consumer information

The model label is affixed to the frame under the passenger seat. (See page 3-19.) Record the information on this label in the space provided. This information will be needed when ordering spare parts from a Yamaha dealer.

Diagnostic connector

EAU69910

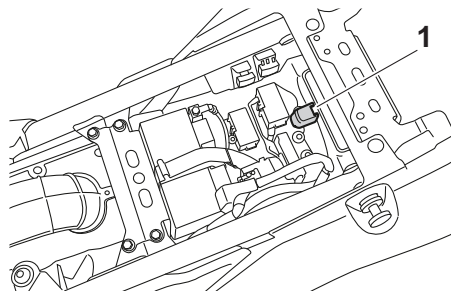

1. Diagnostic connector

The diagnostic connector is located as shown.

Vehicle data recording

EAU85300

This model's ECU stores certain vehicle data to assist in the diagnosis of malfunctions and for research, statistical analysis and development purposes.

Although the sensors and recorded data will vary by model, the main data points are:

- Vehicle status and engine performance data
- Fuel-injection and emission-related data

This data will be uploaded only when a special Yamaha diagnostic tool is attached to the vehicle, such as when maintenance checks or service procedures are performed.

Vehicle data uploaded will be handled appropriately according to the following Privacy Policy.

Privacy Policy

<https://www.yamaha-motor.eu/eu/privacy/privacy-policy.aspx>

Yamaha will not disclose this data to a third party except in the following cases. In addition, Yamaha may provide vehicle data to a contractor in order to outsource services related to the handling of vehicle data. Even in this case, Yamaha will require the contractor to properly handle the vehicle data we provided and Yamaha will appropriately manage the data.

- With the consent of the vehicle owner
- Where obligated by law
- For use by Yamaha in litigation
- When the data is not related to an individual vehicle nor owner

Index

A

- ABS3-15
- ABS off warning light3-4
- ABS warning light3-4
- Air filter element and check hose, replacing and cleaning6-15

B

- Battery6-30
- Brake and clutch levers, checking and lubricating6-27
- Brake and shift pedals, checking and lubricating6-26
- Brake fluid, changing6-23
- Brake fluid level, checking6-22
- Brake lever3-15
- Brake lever free play, checking6-20
- Brake light switches6-21
- Brake pedal3-15

C

- Cables, checking and lubricating6-26
- Canister6-10
- Care7-1
- Catalytic converter3-19
- Clutch lever3-14
- Clutch lever free play, adjusting6-19
- Coolant6-14
- Coolant temperature warning light3-4
- Cowlings, removing and installing6-9

D

- Data recording, vehicle9-2
- DC power outlets3-26
- Diagnostic connector9-2
- Dimmer switch3-13
- Drive chain, cleaning and lubricating6-25

- Drive chain slack6-23

E

- Engine break-in5-1
- Engine oil and oil filter cartridge6-11
- Engine overheating6-37
- Engine serial number9-1
- Engine stop switch3-13
- Engine trouble warning light3-4

F

- Front and rear brake pads, checking ... 6-21
- Front fender3-26
- Front fork, adjusting3-21
- Front fork, bleeding3-23
- Front fork, checking6-29
- Fuel3-17
- Fuel consumption, tips for reducing5-4
- Fuel tank cap3-16
- Fuel tank overflow hose3-19
- Fuses, replacing6-31

H

- Handlebar switches3-12
- Hazard switch3-13
- Headlight beams, adjusting3-21
- High beam indicator light3-3
- Horn switch3-13

I

- Identification numbers9-1
- Ignition circuit cut-off system3-28
- Immobilizer system3-1
- Indicator lights and warning lights3-3

L

- License plate light6-34
- Luggage strap holders3-25

M

- Main switch/steering lock3-2
- Maintenance and lubrication, periodic6-5
- Maintenance, emission control system6-3
- Matte color, caution7-1
- Model label9-1
- Multi-function meter unit3-5

N

- Neutral indicator light3-3

O

- Oil pressure warning light3-3

P

- Parking5-4
- Part locations2-1
- Pass switch3-13

R

- Rear suspension, lubricating6-28

S

- Safety information1-1
- Seats3-19
- SELECT switch3-13
- Shifting5-3
- Shift pedal3-14
- Shock absorber assembly, adjusting3-23
- Sidestand3-27
- Sidestand, checking and lubricating6-28
- Spark plugs, checking6-9
- Specifications8-1
- Starting the engine5-2
- Start switch3-13
- Steering, checking6-29
- Storage7-3
- Supporting the motorcycle6-34

Swingarm pivots, lubricating 6-28

T

Tail/brake light 6-33

Throttle grip and cable, checking and
lubricating..... 6-26

Throttle grip free play, checking..... 6-17

Tires 6-17

Tool kit..... 6-2

Troubleshooting..... 6-35

Troubleshooting chart 6-36

Turn signal indicator lights 3-3

Turn signal light bulb, replacing 6-33

Turn signal switch..... 3-13

V

Valve clearance 6-17

Vehicle identification number 9-1

Vehicle lights 6-33

W

Wheel bearings, checking 6-30

Wheels..... 6-19

Y

Yamalube..... 6-14



MBK Industrie

Z.I. de Rouvroy 02100 Saint Quentin

SAS au capital de 14 000 000 €

R.C St-Quentin B 329 035 422

PRINTED IN FRANCE
2019.07 (E)