



⚠ Read this manual carefully before operating this vehicle.

OWNER'S MANUAL

**XCTV**  
**125**

**VP125**

16P-F8199-E3

 **Read this manual carefully before operating this vehicle. This manual should stay with this vehicle if it is sold.**



**YAMAHA MOTOR ELECTRONICS CO., LTD.**  
 1450-6, Mori, Mori-machi, Shuchi-gun, Shizuoka-ken, 437-0292 Japan

**DECLARATION of CONFORMITY**

**We**

**Company: YAMAHA MOTOR ELECTRONICS CO., LTD.**  
**Address: 1450-6, Mori, Mori-Machi, Shuchi-gun, Shizuoka-Ken, 437-0292 Japan**

**Hereby declare that the product:**

**Kind of equipment: IMMOBILIZER**  
**Type-designation: SSL-00**

**is in compliance with following norm(s) or documents:**

**R&TTE Directive(1999/5/EC)**  
**EN300 330-2 v1.3.1(2006-01), EN300 330-2 v1.5.1(2010-02)**  
**EN60950-1:2006/A11:2009**  
**Two or Three-Wheel Motor Vehicles Directive(97/24/EC: Chapter 8, EMC)**

**Place of issue: Shizuoka, Japan**

**Date of issue: 1 Aug. 2002**

Revision record		
No.	Contents	Date
1	To change contact person and integrate type-designation.	9 Jun. 2005
2	Version up the norm of EN60950 to EN60950-1	27 Feb. 2006
3	To change company name	1 Mar. 2007
4	version up of the following norm: • EN300 330-2 v1.1.1 to EN300 330-2 v1.3.1 and EN300 330-2 v1.5.1 • EN60950-1:2001 to EN60950-1:2006/A11:2009	8 Jul. 2010

General manager of quality assurance div. *July P&H 2010* 



Welcome to the Yamaha world of motorcycling!

As the owner of the VP125, you are benefiting from Yamaha's vast experience and newest technology regarding the design and manufacture of high-quality products, which have earned Yamaha a reputation for dependability.

Please take the time to read this manual thoroughly, so as to enjoy all advantages of your VP125. The Owner's Manual does not only instruct you in how to operate, inspect and maintain your scooter, but also in how to safeguard yourself and others from trouble and injury.

In addition, the many tips given in this manual will help keep your scooter in the best possible condition. If you have any further questions, do not hesitate to contact your Yamaha dealer.

The Yamaha team wishes you many safe and pleasant rides. So, remember to put safety first!

Yamaha continually seeks advancements in product design and quality. Therefore, while this manual contains the most current product information available at the time of printing, there may be minor discrepancies between your scooter and this manual. If there is any question concerning this manual, please consult a Yamaha dealer.



---

**Please read this manual carefully and completely before operating this scooter.**

---



# IMPORTANT MANUAL INFORMATION

---

---

EAU10133

Particularly important information is distinguished in this manual by the following notations:

	<b>This is the safety alert symbol. It is used to alert you to potential personal injury hazards. Obey all safety messages that follow this symbol to avoid possible injury or death.</b>
	<b>A WARNING indicates a hazardous situation which, if not avoided, could result in death or serious injury.</b>
	<b>A NOTICE indicates special precautions that must be taken to avoid damage to the vehicle or other property.</b>
<b>TIP</b>	A TIP provides key information to make procedures easier or clearer.

\*Product and specifications are subject to change without notice.

# **IMPORTANT MANUAL INFORMATION**

---

---

EAUM1011

**VP125  
OWNER'S MANUAL  
©2012 by MBK INDUSTRIE  
1st edition, June 2012  
All rights reserved  
Any reprinting or unauthorized use  
without the written permission of  
MBK INDUSTRIE  
is expressly prohibited.  
Printed in France.**

# TABLE OF CONTENTS

---

<b>SAFETY INFORMATION</b> .....	1-1	Ignition circuit cut-off system .....	3-17	Checking the throttle grip free play .....	6-16
Further safe-riding points .....	1-5			Valve clearance .....	6-17
<b>DESCRIPTION</b> .....	2-1	<b>FOR YOUR SAFETY –</b>		Tires .....	6-17
Left view .....	2-1	<b>PRE-OPERATION CHECKS</b> .....	4-1	Cast wheels .....	6-19
Right view .....	2-2			Front and rear brake lever free play .....	6-19
Controls and instruments.....	2-3	<b>OPERATION AND IMPORTANT</b>		Checking the front and rear brake pads .....	6-20
<b>INSTRUMENT AND CONTROL</b>		<b>RIDING POINTS</b> .....	5-1	Checking the brake fluid level .....	6-21
<b>FUNCTIONS</b> .....	3-1	Starting the engine .....	5-1	Changing the brake fluid .....	6-22
Immobilizer system .....	3-1	Starting off .....	5-2	Checking and lubricating the cables .....	6-22
Main switch/steering lock .....	3-2	Acceleration and deceleration .....	5-3	Checking and lubricating the throttle grip and cable .....	6-23
Indicator lights and warning light .....	3-3	Braking .....	5-3	Lubricating the front and rear brake levers .....	6-23
Speedometer .....	3-4	Tips for reducing fuel consumption .....	5-4	Checking and lubricating the centerstand and sidestand .....	6-23
Fuel gauge .....	3-5	Engine break-in .....	5-4	Checking the front fork .....	6-24
Coolant temperature gauge .....	3-5	Parking .....	5-5	Checking the steering .....	6-25
Multi-function display .....	3-5	<b>PERIODIC MAINTENANCE AND</b>		Checking the wheel bearings .....	6-25
Handlebar switches .....	3-8	<b>ADJUSTMENT</b> .....	6-1	Battery .....	6-25
Front brake lever .....	3-9	Owner's tool kit .....	6-2	Replacing the fuses .....	6-27
Rear brake lever .....	3-9	Periodic maintenance chart for the emission control system .....	6-3	Replacing a headlight bulb .....	6-28
Fuel tank cap .....	3-10	General maintenance and lubrication chart .....	6-4	Replacing a front turn signal light bulb .....	6-29
Fuel .....	3-10	Removing and installing cowlings and panels .....	6-8	Replacing a tail/brake light bulb or a rear turn signal light bulb .....	6-30
Catalytic converters .....	3-12	Checking the spark plug .....	6-9	Replacing the license plate light bulb .....	6-31
Seat .....	3-12	Engine oil .....	6-10		
Storage compartments .....	3-13	Final transmission oil .....	6-13		
Windshield .....	3-14	Coolant .....	6-14		
Adjusting the shock absorber assemblies .....	3-15	Air filter and V-belt case air filter elements .....	6-15		
Carrier .....	3-16				
Luggage hook .....	3-16				
Sidestand .....	3-16				

# TABLE OF CONTENTS

---

---

Replacing an auxiliary light bulb ...6-31  
Troubleshooting .....6-31  
Troubleshooting charts .....6-33

**SCOOTER CARE AND STORAGE ...7-1**  
Care .....7-1  
Storage .....7-3

**SPECIFICATIONS .....8-1**

**CONSUMER INFORMATION.....9-1**  
Identification numbers .....9-1

## Be a Responsible Owner

As the vehicle's owner, you are responsible for the safe and proper operation of your scooter.

Scooters are single-track vehicles.

Their safe use and operation are dependent upon the use of proper riding techniques as well as the expertise of the operator. Every operator should know the following requirements before riding this scooter.

He or she should:

- Obtain thorough instructions from a competent source on all aspects of scooter operation.
- Observe the warnings and maintenance requirements in this Owner's Manual.
- Obtain qualified training in safe and proper riding techniques.
- Obtain professional technical service as indicated in this Owner's Manual and/or when made necessary by mechanical conditions.

- Never operate a scooter without proper training or instruction. Take a training course. Beginners should receive training from a certified instructor. Contact an authorized scooter dealer to find out about the training courses nearest you.

## Safe Riding

Perform the pre-operation checks each time you use the vehicle to make sure it is in safe operating condition. Failure to inspect or maintain the vehicle properly increases the possibility of an accident or equipment damage. See page 4-1 for a list of pre-operation checks.

- This scooter is designed to carry the operator and a passenger.
- The failure of motorists to detect and recognize scooters in traffic is the predominating cause of automobile/scooter accidents. Many accidents have been caused by an automobile driver who did not see the scooter. Making yourself conspicu-

ous appears to be very effective in reducing the chance of this type of accident.

### Therefore:

- Wear a brightly colored jacket.
- Use extra caution when you are approaching and passing through intersections, since intersections are the most likely places for scooter accidents to occur.
- Ride where other motorists can see you. Avoid riding in another motorist's blind spot.
- Never maintain a scooter without proper knowledge. Contact an authorized scooter dealer to inform you on basic scooter maintenance. Certain maintenance can only be carried out by certified staff.



- Many accidents involve inexperienced operators. In fact, many operators who have been involved in accidents do not even have a current driver's license.
  - Make sure that you are qualified and that you only lend your scooter to other qualified operators.
  - Know your skills and limits. Staying within your limits may help you to avoid an accident.
  - We recommend that you practice riding your scooter where there is no traffic until you have become thoroughly familiar with the scooter and all of its controls.
- Many accidents have been caused by error of the scooter operator. A typical error made by the operator is veering wide on a turn due to excessive speed or undercornering (insufficient lean angle for the speed).
  - Always obey the speed limit and never travel faster than warranted by road and traffic conditions.
  - Always signal before turning or changing lanes. Make sure that other motorists can see you.
- The posture of the operator and passenger is important for proper control.
  - The operator should keep both hands on the handlebar and both feet on the operator footrests during operation to maintain control of the scooter.
  - The passenger should always hold onto the operator, the seat strap or grab bar, if equipped, with both hands and keep both feet on the passenger footrests. Never carry a passenger unless he or she can firmly place both feet on the passenger footrests.
- Never ride under the influence of alcohol or other drugs.
- This scooter is designed for on-road use only. It is not suitable for off-road use.

### **Protective Apparel**

The majority of fatalities from scooter accidents are the result of head injuries. The use of a safety helmet is the single most critical factor in the prevention or reduction of head injuries.

- Always wear an approved helmet.
- Wear a face shield or goggles. Wind in your unprotected eyes could contribute to an impairment of vision that could delay seeing a hazard.
- The use of a jacket, substantial shoes, trousers, gloves, etc., is effective in preventing or reducing abrasions or lacerations.
- Never wear loose-fitting clothes, otherwise they could catch on the control levers or wheels and cause injury or an accident.
- Always wear protective clothing that covers your legs, ankles, and feet. The engine or exhaust system become very hot during or after operation and can cause burns.
- A passenger should also observe the above precautions.

# SAFETY INFORMATION

1

## **Avoid Carbon Monoxide Poisoning**

All engine exhaust contains carbon monoxide, a deadly gas. Breathing carbon monoxide can cause headaches, dizziness, drowsiness, nausea, confusion, and eventually death.

Carbon Monoxide is a colorless, odorless, tasteless gas which may be present even if you do not see or smell any engine exhaust. Deadly levels of carbon monoxide can collect rapidly and you can quickly be overcome and unable to save yourself. Also, deadly levels of carbon monoxide can linger for hours or days in enclosed or poorly ventilated areas. If you experience any symptoms of carbon monoxide poisoning, leave the area immediately, get fresh air, and **SEEK MEDICAL TREATMENT**.

- Do not run engine indoors. Even if you try to ventilate engine exhaust with fans or open windows and doors, carbon monoxide can rapidly reach dangerous levels.
- Do not run engine in poorly ventilated or partially enclosed areas such as barns, garages, or carports.

- Do not run engine outdoors where engine exhaust can be drawn into a building through openings such as windows and doors.

## **Loading**

Adding accessories or cargo to your scooter can adversely affect stability and handling if the weight distribution of the scooter is changed. To avoid the possibility of an accident, use extreme caution when adding cargo or accessories to your scooter. Use extra care when riding a scooter that has added cargo or accessories. Here, along with the information about accessories below, are some general guidelines to follow if loading cargo to your scooter:

The total weight of the operator, passenger, accessories and cargo must not exceed the maximum load limit.

**Operation of an overloaded vehicle could cause an accident.**

<p><b>Maximum load:</b> 185 kg (408 lb)</p>
---

When loading within this weight limit, keep the following in mind:

- Cargo and accessory weight should be kept as low and close to the scooter as possible. Securely pack your heaviest items as close to the center of the vehicle as possible and make sure to distribute the weight as evenly as possible on both sides of the scooter to minimize imbalance or instability.
- Shifting weights can create a sudden imbalance. Make sure that accessories and cargo are securely attached to the scooter before riding. Check accessory mounts and cargo restraints frequently.
  - Properly adjust the suspension for your load (suspension-adjustable models only), and check the condition and pressure of your tires.
  - Never attach any large or heavy items to the handlebar, front fork, or front fender. Such items can create unstable handling or a slow steering response.
- **This vehicle is not designed to pull a trailer or to be attached to a sidecar.**

### **Genuine Yamaha Accessories**

Choosing accessories for your vehicle is an important decision. Genuine Yamaha accessories, which are available only from a Yamaha dealer, have been designed, tested, and approved by Yamaha for use on your vehicle.

Many companies with no connection to Yamaha manufacture parts and accessories or offer other modifications for Yamaha vehicles. Yamaha is not in a position to test the products that these aftermarket companies produce. Therefore, Yamaha can neither endorse nor recommend the use of accessories not sold by Yamaha or modifications not specifically recommended by Yamaha, even if sold and installed by a Yamaha dealer.

### **Aftermarket Parts, Accessories, and Modifications**

While you may find aftermarket products similar in design and quality to genuine Yamaha accessories, recognize that some aftermarket accessories or modifications are not suitable because of potential safety hazards to you or others. Installing aftermarket prod-

ucts or having other modifications performed to your vehicle that change any of the vehicle's design or operation characteristics can put you and others at greater risk of serious injury or death. You are responsible for injuries related to changes in the vehicle.

Keep the following guidelines in mind, as well as those provided under "Loading" when mounting accessories.

- Never install accessories or carry cargo that would impair the performance of your scooter. Carefully inspect the accessory before using it to make sure that it does not in any way reduce ground clearance or cornering clearance, limit suspension travel, steering travel or control operation, or obscure lights or reflectors.
- Accessories fitted to the handlebar or the front fork area can create instability due to improper weight distribution or aerodynamic changes. If accessories are added to the handlebar or front fork area, they must be as lightweight as possible and should be kept to a minimum.

- Bulky or large accessories may seriously affect the stability of the scooter due to aerodynamic effects. Wind may attempt to lift the scooter, or the scooter may become unstable in cross winds. These accessories may also cause instability when passing or being passed by large vehicles.
- Certain accessories can displace the operator from his or her normal riding position. This improper position limits the freedom of movement of the operator and may limit control ability, therefore, such accessories are not recommended.
- Use caution when adding electrical accessories. If electrical accessories exceed the capacity of the scooter's electrical system, an electric failure could result, which could cause a dangerous loss of lights or engine power.

# SAFETY INFORMATION

1

## Aftermarket Tires and Rims

The tires and rims that came with your scooter were designed to match the performance capabilities and to provide the best combination of handling, braking, and comfort. Other tires, rims, sizes, and combinations may not be appropriate. Refer to page 6-17 for tire specifications and more information on replacing your tires.

## Transporting the Scooter

Be sure to observe following instructions before transporting the scooter in another vehicle.

- Remove all loose items from the scooter.
- Point the front wheel straight ahead on the trailer or in the truck bed, and choke it in a rail to prevent movement.
- Secure the scooter with tie-downs or suitable straps that are attached to solid parts of the scooter, such as the frame or upper front fork triple clamp (and not, for example, to rubber-mounted handlebars or turn signals, or parts that could break). Choose the location for the

straps carefully so the straps will not rub against painted surfaces during transport.

- The suspension should be compressed somewhat by the tie-downs, if possible, so that the scooter will not bounce excessively during transport.

EAU10373

## Further safe-riding points

- Be sure to signal clearly when making turns.
- Braking can be extremely difficult on a wet road. Avoid hard braking, because the scooter could slide. Apply the brakes slowly when stopping on a wet surface.
- Slow down as you approach a corner or turn. Once you have completed a turn, accelerate slowly.
- Be careful when passing parked cars. A driver might not see you and open a door in your path.
- Railroad crossings, streetcar rails, iron plates on road construction sites, and manhole covers become extremely slippery when wet. Slow down and cross them with caution. Keep the scooter upright, otherwise it could slide out from under you.
- The brake pads could get wet when you wash the scooter. After washing the scooter, check the brakes before riding.

- Always wear a helmet, gloves, trousers (tapered around the cuff and ankle so they do not flap), and a bright colored jacket.
- Do not carry too much luggage on the scooter. An overloaded scooter is unstable. Use a strong cord to secure any luggage to the carrier (if equipped). A loose load will affect the stability of the scooter and could divert your attention from the road. (See page 1-3.)

# DESCRIPTION

EAU10410

## Left view

2

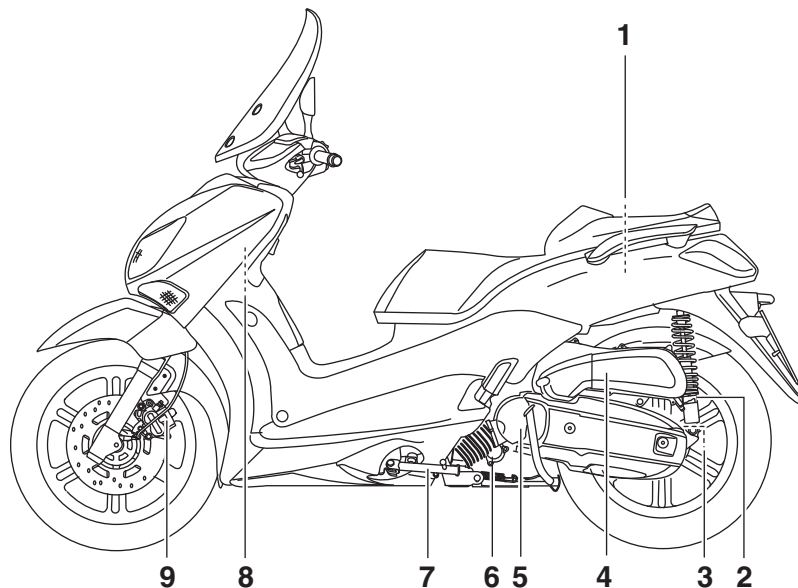

- 1. Rear storage compartment (page 3-13)
- 2. Shock absorber assembly spring preload adjusting ring (page 3-15)
- 3. Final transmission oil filler cap (page 6-13)
- 4. Air filter element (page 6-15)
- 5. V-belt case air filter element (page 6-15)
- 6. Engine oil filter element (page 6-10)
- 7. Sidestand (page 3-16)
- 8. Coolant level check window (page 6-14)

- 9. Front brake pads (page 6-20)

## Right view

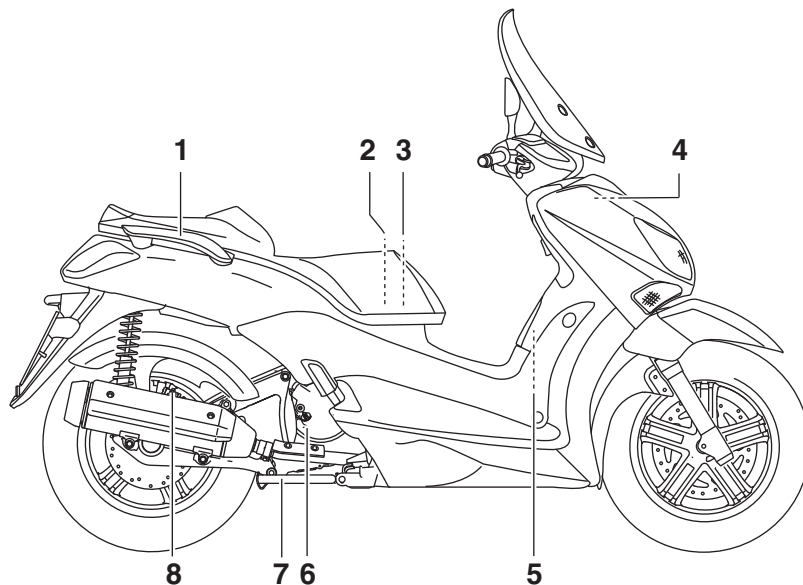

1. Grab bar (page 5-2)
2. Main fuse/fuse box (page 6-27)
3. Battery (page 6-25)
4. Coolant reservoir cap (page 6-14)
5. Fuel tank cap (page 3-10)
6. Engine oil filler cap (page 6-10)
7. Centerstand (page 6-23)
8. Rear brake pads (page 6-20)

# DESCRIPTION

---

EAU10430

## Controls and instruments

2

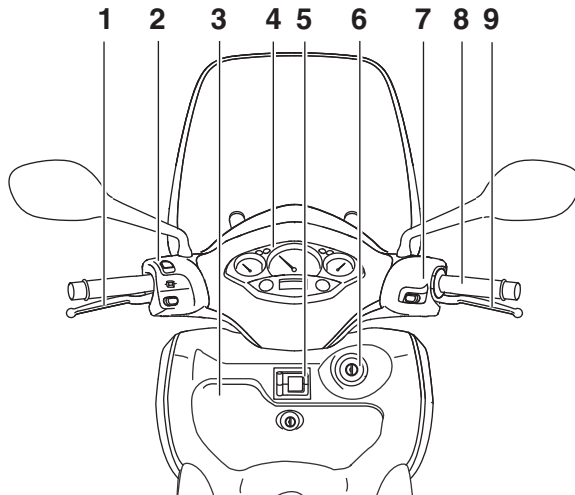

1. Rear brake lever (page 3-9)
2. Left handlebar switches (page 3-8)
3. Front storage compartment (page 3-13)
4. Speedometer/Multi-function display (page 3-4/page 3-5)
5. Luggage hook (page 3-16)
6. Main switch/steering lock (page 3-2)
7. Right handlebar switch (page 3-8)
8. Throttle grip (page 6-16)

9. Front brake lever (page 3-9)



## Immobilizer system

EAU10977

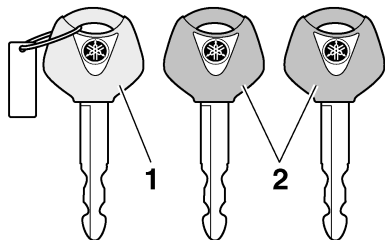

1. Code re-registering key (red bow)
2. Standard keys (black bow)

This vehicle is equipped with an immobilizer system to help prevent theft by re-registering codes in the standard keys. This system consists of the following:

- a code re-registering key (with a red bow)
- two standard keys (with a black bow) that can be re-registered with new codes
- a transponder (which is installed in the code re-registering key)
- an immobilizer unit
- an ECU

- an immobilizer system indicator light (See page 3-3.)

The key with the red bow is used to register codes in each standard key. Since re-registering is a difficult process, take the vehicle along with all three keys to a Yamaha dealer to have them re-registered. Do not use the key with the red bow for driving. It should only be used for re-registering the standard keys. Always use a standard key for driving.

ECA11821

### NOTICE

- **DO NOT LOSE THE CODE RE-REGISTERING KEY! CONTACT YOUR DEALER IMMEDIATELY IF IT IS LOST!** If the code re-registering key is lost, registering new codes in the standard keys is impossible. The standard keys can still be used to start the vehicle, however if code re-registering is required (i.e., if a new standard key is made or all keys are lost) the entire immobilizer system must be replaced. Therefore, it is highly recom-

mended to use either standard key and keep the code re-registering key in a safe place.

- Do not submerge any key in water.
- Do not expose any key to excessively high temperatures.
- Do not place any key close to magnets (this includes, but not limited to, products such as speakers, etc.).
- Do not place items that transmit electrical signals close to any key.
- Do not place heavy items on any key.
- Do not grind any key or alter its shape.
- Do not disassemble the plastic part of any key.
- Do not put two keys of any immobilizer system on the same key ring.
- Keep the standard keys as well as keys of other immobilizer systems away from this vehicle's code re-registering key.

# INSTRUMENT AND CONTROL FUNCTIONS

- Keep other immobilizer system keys away from the main switch as they may cause signal interference.

## Main switch/steering lock

EAU10472

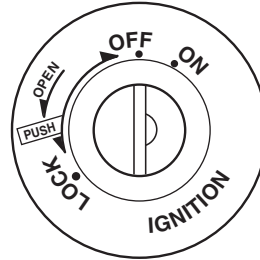

ZAJUM066

The main switch/steering lock controls the ignition and lighting systems, and is used to lock the steering. The various positions are described below.

### TIP

Be sure to use the standard key (black bow) for regular use of the vehicle. To minimize the risk of losing the code re-registering key (red bow), keep it in a safe place and only use it for code re-registering.

EAU34121

### ON

All electrical circuits are supplied with power; the meter lighting, taillight, license plate light and auxiliary lights come on, and the engine can be started. The key cannot be removed.

### TIP

The headlights come on automatically when the engine is started and stay on until the key is turned to “OFF” or the sidestand is moved down.

EAU10661

### OFF

All electrical systems are off. The key can be removed.

EWA10061

### **⚠ WARNING**

**Never turn the key to “OFF” or “LOCK” while the vehicle is moving. Otherwise the electrical systems will be switched off, which may result in loss of control or an accident.**

# INSTRUMENT AND CONTROL FUNCTIONS

## LOCK

EAU10684

The steering is locked, and all electrical systems are off. The key can be removed.

## To lock the steering

1. Turn the handlebars all the way to the left.
2. Push the key in from the “OFF” position, and then turn it to “LOCK” while still pushing it.
3. Remove the key.

## To unlock the steering

Push the key in, and then turn it to “OFF” while still pushing it.

## Indicator lights and warning light

EAU11006

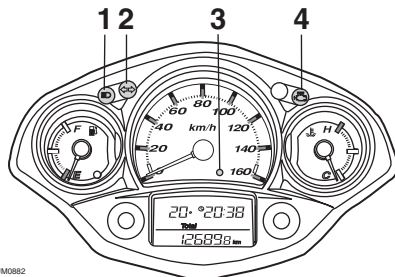

ZAJM0882

1. High beam indicator light “≡”
2. Turn signal indicator light “← →”
3. Immobilizer system indicator light “⊢”
4. Engine trouble warning light “⚙️”

## Turn signal indicator light “← →”

EAU11020

This indicator light flashes when the turn signal switch is pushed to the left or right.

## High beam indicator light “≡”

EAU11080

This indicator light comes on when the high beam of the headlight is switched on.

## Engine trouble warning light “⚙️”

EAU1540

This warning light flashes if a problem is detected in the electrical circuit monitoring the engine. If this occurs, have a Yamaha dealer check the self-diagnosis system.

The electrical circuit of the warning light can be checked by turning the key to “ON”. If the warning light does not come on for a few seconds, then go off, have a Yamaha dealer check the electrical circuit.

## Immobilizer system indicator light

EAU38914

The electrical circuit of the indicator light can be checked by turning the key to “ON”. The indicator light should come on for a few seconds, and then go off.

If the indicator light does not come on initially when the key is turned to “ON”, or if the indicator light remains on, have a Yamaha dealer check the electrical circuit.

When the key is turned to “OFF” and 30 seconds have passed, the indicator light will start flashing indicating the immobilizer system is enabled. After 24

# INSTRUMENT AND CONTROL FUNCTIONS

hours have passed, the indicator light will stop flashing, however the immobilizer system is still enabled.

## TIP \_\_\_\_\_

The self-diagnosis device also detects problems in the immobilizer system circuits. If the immobilizer system is not working correctly, the indicator light will start flashing a pattern when the key is turned to "ON". When this occurs, have a Yamaha dealer check the self-diagnosis system. However, if the indicator light slowly flashes five times, and then quickly flashes two times repeatedly, this error could be caused by signal interference. If this occurs, try the following.

1. Use the code re-registering key to start the engine.

## TIP \_\_\_\_\_

Make sure there are no other immobilizer keys close to the main switch, and do not keep more than one immobilizer key on the same key ring! Immobilizer system keys may cause signal interference, which may prevent the engine from starting.

2. If the engine starts, turn it off, and try starting the engine with the standard keys.
3. If one or both of the standard keys do not start the engine, take the vehicle, the code re-registering key and both standard keys to a Yamaha dealer and have the standard keys re-registered.

## Speedometer

EAU11591

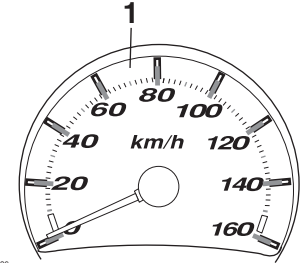

ZALUM0636

1. Speedometer

## UK ONLY

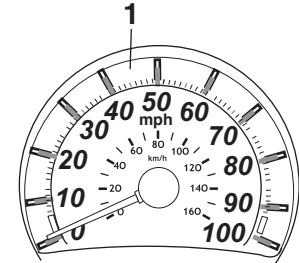

ZALUM0637

1. Speedometer

The speedometer shows the riding speed.

# INSTRUMENT AND CONTROL FUNCTIONS

## Fuel gauge

EAUM1471

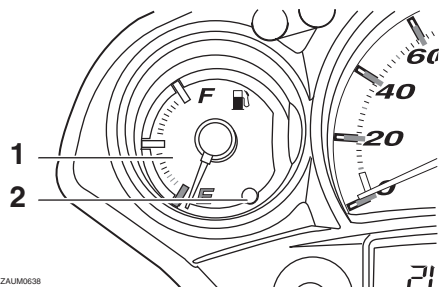

ZAU00638

1. Fuel gauge
2. Fuel level warning light

The fuel gauge indicates the amount of fuel in the fuel tank. The needle moves towards “E” (Empty) as the fuel level decreases. When the remaining fuel in the tank reaches approximately 2.7 L (0.72 US gal, 0.60 Imp.gal), the fuel level warning light will come on and the multi-function display will automatically change to the “Trip/fuel” mode. (See page 3-6.) If this occurs, refuel as soon as possible.

### TIP

Do not allow the fuel tank to empty itself completely.

## Coolant temperature gauge

EAU12173

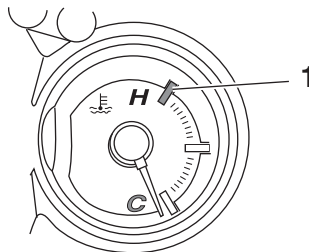

ZAU00639

1. Red zone

With the key in the “ON” position, the coolant temperature gauge indicates the temperature of the coolant. The coolant temperature varies with changes in the weather and engine load. If the needle reaches or enters the red zone, stop the vehicle and let the engine cool. (See page 6-34.)

### NOTICE

**Do not continue to operate the engine if it is overheating.**

ECA10021

## Multi-function display

EAUM2750

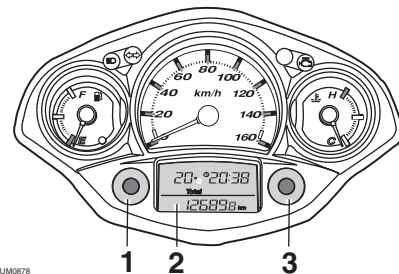

ZAU00678

1. “MODE” button
2. Multi-function display
3. “SET” button

### WARNING

**Be sure to stop the vehicle before making any setting changes to the multi-function display. Changing settings while riding can distract the operator and increase the risk of an accident.**

The multi-function display is equipped with the following:

- an odometer (which shows the total distance traveled)

EWA12312

# INSTRUMENT AND CONTROL FUNCTIONS

3

- two tripmeters (which show the distance traveled since they were last set to zero, the time passed since the tripmeters were set to zero, and the average speed traveled during this time)
- a fuel reserve tripmeter (which shows the distance traveled since the fuel level warning light came on)
- a clock
- an ambient temperature display
- an oil change indicator (which comes on when the engine oil should be changed)

## TIP

- For the UK, the distance traveled is displayed in miles and the temperature reading is displayed in °F.
- For other countries, the distance traveled is displayed in kilometers and the temperature reading is displayed in °C.

## Odometer and tripmeter modes

Pushing the “MODE” button switches the display between the odometer mode “Total” and the tripmeter modes “Trip” in the following order:

Total → Trip 1 → Trip 2 → Trip/fuel → Total

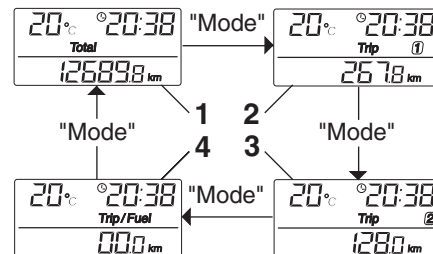

ZALUM0391

1. Total
2. Trip 1
3. Trip 2
4. Trip/Fuel

## TIP

The Trip/fuel odometer is only activated if the fuel level warning light comes on.

Pushing the “SET” button when in the tripmeter mode switches the display between the different tripmeter functions in the following order:

Trip 1 or Trip 2 → Time 1 or 2 → Average speed 1 or 2 → Trip 1 or Trip 2

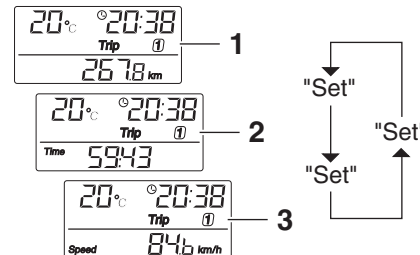

ZALUM0392

1. Distance
2. Time
3. Average speed

If the fuel level warning light comes on (See page 3-5.), the display will automatically change to the fuel reserve tripmeter mode “Trip/fuel” and start counting the distance traveled from that point. In that case, pushing the “MODE” button switches the display between the various tripmeter and odometer modes in the following order:

Trip/Fuel → Trip 1 → Trip 2 → Total → Trip/fuel

# INSTRUMENT AND CONTROL FUNCTIONS

## Ambient temperature display

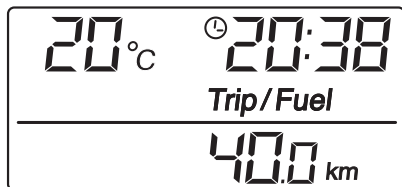

ZAUM0393

To reset a tripmeter, select it by pushing the “MODE” button, and then push the “SET” button for at least one second. If you do not reset the fuel reserve tripmeter manually, it will reset itself automatically and the display will return to the prior mode after refueling and traveling 5 km (3 mi).

### Clock mode

To set the clock:

1. When the display is in the “Total” mode, push the “SET” button for at least two seconds.
2. When the hour digits start flashing, push the “SET” button to set the hours.

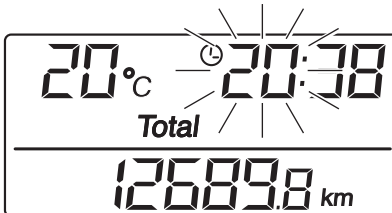

ZAUM0394

3. Push the “MODE” button, and the minute digits will start flashing.
4. Push the “SET” button to set the minutes.
5. Push the “MODE” button and then release it to start the clock. The display will return to the “Total” mode.

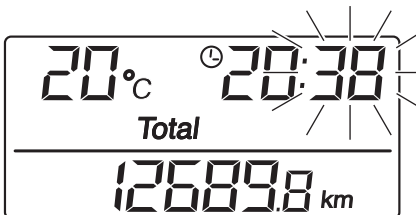

ZAUM0395

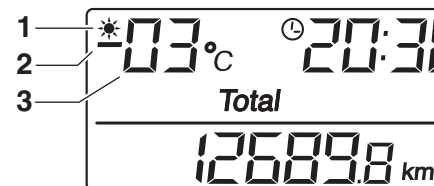

ZAUM0396

1. Frost warning indicator “❄️”
2. Minus item
3. Temperature

This display shows the ambient temperature from -30 °C (-86 °F) to 50 °C (122 °F).

The frost warning indicator “❄️” automatically comes on if the temperature is lower than 3 °C (37 °F).

# INSTRUMENT AND CONTROL FUNCTIONS

## Oil change indicator “OIL”

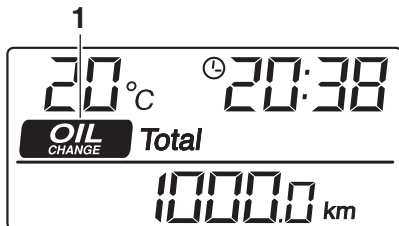

ZALUM0879

### 1. Oil change indicator “OIL”

The engine oil should be changed when this indicator comes on. The indicator stays on until it is reset. After changing the engine oil, reset the indicator as follows.

1. With the key turned to “ON”, while holding the “MODE” and “SET” buttons pushed, turn the key to “OFF”, and then turn the key back to “ON”.
2. Continue holding the “MODE” and “SET” buttons pushed for two to five seconds.
3. Release the buttons and the oil change indicator will go off.

## TIP

- The oil change indicator will come on at the initial 1000 km (600 mi), 5000 km (3000 mi) after the initial 1000 km (600 mi) and every 6000 km (3600 mi) thereafter.
- If the engine oil is changed before the oil change indicator comes on (i.e. before the periodic oil change interval has been reached), the indicator must be reset after the oil change for the next periodic oil change to be indicated at the correct time. After resetting, the indicator will come on for two seconds. If the indicator does not come on, repeat the procedure.

## Handlebar switches

EAU1234A

### Left

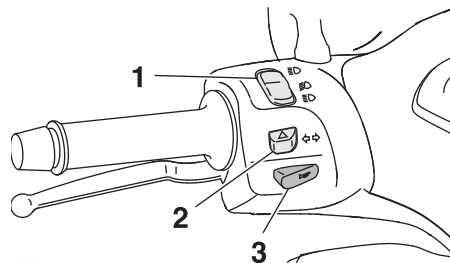

ZALUM0841

1. Dimmer “ / ” / Pass “” switch
2. Turn signal switch “ / ”
3. Horn switch “”

### Right

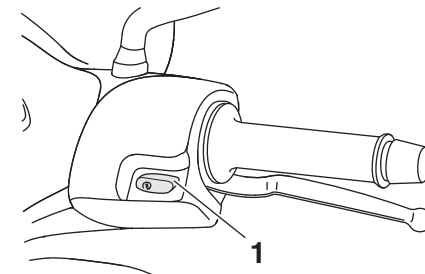

ZALUM0642



1. Start switch “”



# INSTRUMENT AND CONTROL FUNCTIONS



## Dimmer switch “/”

EAU1020

Set this switch to “” for the high beam and to “” for the low beam. With the headlight on low beam, press this switch downwards to flash the headlight.

## Turn signal switch “/”

EAU12460

To signal a right-hand turn, push this switch to “”. To signal a left-hand turn, push this switch to “”. When released, the switch returns to the center position. To cancel the turn signal lights, push the switch in after it has returned to the center position.

## Horn switch “”

EAU12500

Press this switch to sound the horn.

## Start switch “”

EAU12721

With the sidestand up, push this switch while applying the front or rear brake to crank the engine with the starter. See page 5-1 for starting instructions prior to starting the engine.

## Front brake lever

EAU12901

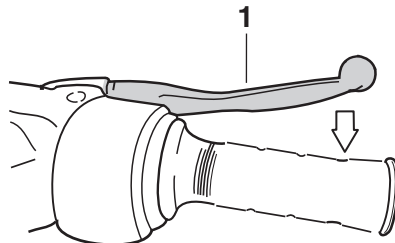

ZAJM0791

### 1. Front brake lever

The front brake lever is located on the right side of the handlebar. To apply the front brake, pull this lever toward the throttle grip.

## Rear brake lever

EAU12951

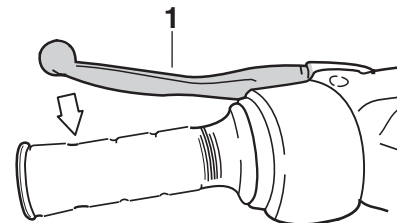

ZAJM0085

### 1. Rear brake lever

The rear brake lever is located on the left side of the handlebar. To apply the rear brake, pull this lever toward the handlebar grip.

# INSTRUMENT AND CONTROL FUNCTIONS

## Fuel tank cap

EAUM2161

EWA11091

EAU13212

### To open the fuel tank cap

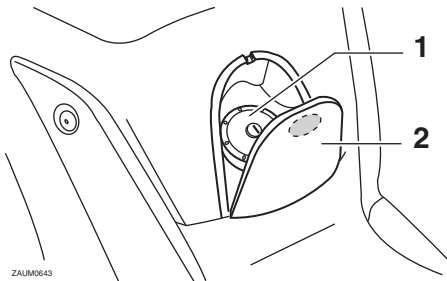

1. Fuel tank cap
2. Fuel tank cap cover

1. Open the fuel tank cap cover by pushing in on the front end of it.
2. Insert the key in the lock and turn it clockwise.

### To close the fuel tank cap

1. Align the match marks, and then push the fuel tank cap into the original position.
2. Turn the key counterclockwise and remove it.
3. Close the fuel tank cover.



**Make sure that the fuel tank cap is properly closed after filling fuel. Leaking fuel is a fire hazard.**

## Fuel

Make sure there is sufficient gasoline in the tank.

EWA10881



**Gasoline and gasoline vapors are extremely flammable. To avoid fires and explosions and to reduce the risk of injury when refueling, follow these instructions.**

1. Before refueling, turn off the engine and be sure that no one is sitting on the vehicle. Never refuel while smoking, or while in the vicinity of sparks, open flames, or other sources of ignition such as the pilot lights of water heaters and clothes dryers.
2. Do not overfill the fuel tank. Stop filling when the fuel reaches the bottom of the filler tube. Because fuel expands when it heats up, heat from the engine or the sun can cause fuel to spill out of the fuel tank.

# INSTRUMENT AND CONTROL FUNCTIONS

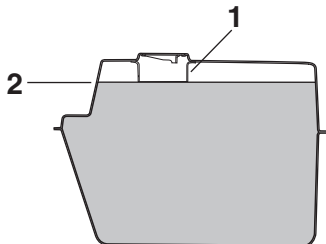

ZAJM0020

1. Fuel tank filler tube
2. Maximum fuel level
3. Wipe up any spilled fuel immediately. **NOTICE: Immediately wipe off spilled fuel with a clean, dry, soft cloth, since fuel may deteriorate painted surfaces or plastic parts.** [ECA10071]
4. Be sure to securely close the fuel tank cap.

EWA15151

## **WARNING**

Gasoline is poisonous and can cause injury or death. Handle gasoline with care. Never siphon gasoline by mouth. If you should swallow some gasoline or inhale a lot of gasoline vapor, or get some gasoline in your eyes, see your doctor immedi-

ately. If gasoline spills on your skin, wash with soap and water. If gasoline spills on your clothing, change your clothes.

brand. Use of unleaded fuel will extend spark plug life and reduce maintenance costs.

EAU43422

### Recommended fuel:

Premium unleaded gasoline only

### Fuel tank capacity:

10.5 L (2.77 US gal, 2.31 Imp.gal)

### Fuel reserve amount (when the fuel level warning indicator flashes):

2.7 L (0.72 US gal, 0.60 Imp.gal)

ECA11400

## **NOTICE**

Use only unleaded gasoline. The use of leaded gasoline will cause severe damage to internal engine parts, such as the valves and piston rings, as well as to the exhaust system.

Your Yamaha engine has been designed to use premium unleaded gasoline with a research octane number of 95 or higher. If knocking (or pinging) occurs, use a gasoline of a different

# INSTRUMENT AND CONTROL FUNCTIONS

## Catalytic converters

EAU13445

This vehicle is equipped with catalytic converters in the exhaust system.

EWA10862

### **WARNING**

The exhaust system is hot after operation. To prevent a fire hazard or burns:

- Do not park the vehicle near possible fire hazards such as grass or other materials that easily burn.
- Park the vehicle in a place where pedestrians or children are not likely to touch the hot exhaust system.
- Make sure that the exhaust system has cooled down before doing any maintenance work.
- Do not allow the engine to idle more than a few minutes. Long idling can cause a build-up of heat.

### **NOTICE**

Use only unleaded gasoline. The use of leaded gasoline will cause unrepairable damage to the catalytic converter.

ECA10701

## Seat

EAU13932

### To open the seat

1. Place the scooter on the center-stand.
2. Insert the key into the main switch, and then turn it counterclockwise to "OPEN".

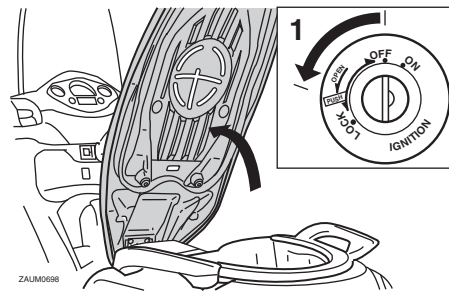

1. Open.

### **TIP**

Do not push inward when turning the key.

3. Fold the seat up.

### To close the seat

1. Fold the seat down, and then push it down to lock it in place.

2. Remove the key from the main switch if the scooter will be left unattended.

## TIP

Make sure that the seat is properly secured before riding.

## Storage compartments

EAUM2522

### Front storage compartment

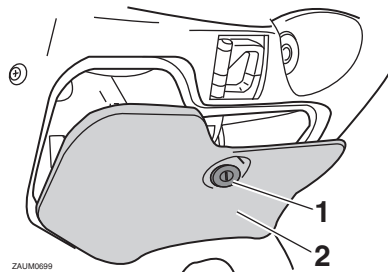

1. Lock.
2. Front storage compartment

### To open the storage compartment

Insert the key into the lock, turn it clockwise, and then pull on it to open the storage compartment lid.

### To close the storage compartment

Push the storage compartment lid into the original position, and then remove the key.

## **!** WARNING

- Do not exceed the load limit of 1 kg (2 lb) for the front storage compartment.
- Do not exceed the maximum load of 185 kg (408 lb) for the vehicle.

### Rear storage compartment

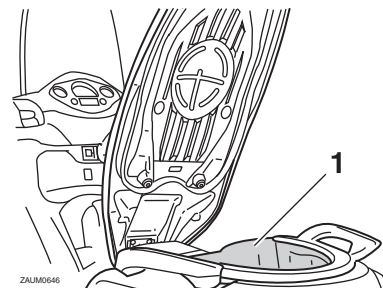

1. Rear storage compartment

There is a storage compartment under the seat. (See page 3-12.)

## **!** WARNING

- Do not exceed the load limit of 5 kg (11 lb) for the rear storage compartment.

EWA11191

# INSTRUMENT AND CONTROL FUNCTIONS

- Do not exceed the maximum load of 185 kg (408 lb) for the vehicle.

ECA10081

## NOTICE

Keep the following points in mind when using the storage compartment.

- Since the storage compartment accumulates heat when exposed to the sun and/or the engine heat, do not store anything susceptible to heat, consumables or flammable items inside it.
- To avoid humidity from spreading through the storage compartment, wrap wet articles in a plastic bag before storing them in the compartment.
- Since the storage compartment may get wet while the scooter is being washed, wrap any articles stored in the compartment in a plastic bag.
- Do not keep anything valuable or breakable in the storage compartment.

To store a helmet in the storage compartment, place the helmet with the front facing backward.

## TIP

- Some helmets cannot be stored in the storage compartment because of their size or shape.
- Do not leave your scooter unattended with the seat open.

## Windshield

EAUM2490

To suit the rider's preference, the windshield height can be changed to one of four positions.

### To adjust the windshield height

1. Remove the bolts on each side of the windshield.

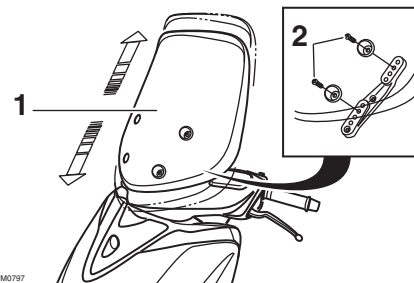

ZALIM0797

1. Windshield
2. Bolt

2. Move the windshield to the desired position.
3. Install the bolts and tighten them to the specified torque.

### Tightening torque:

Windshield bolt:  
4 Nm (0.4 m·kgf, 2.9 ft·lbf)

# INSTRUMENT AND CONTROL FUNCTIONS

## **WARNING**

EWA10920

After adjusting the windshield:

- Securely tighten the windshield bolts.
- Turn the handlebar to the left and right to make sure that the handlebar is not obstructed and that the windshield does not contact any other parts.
- Open the throttle and make sure that the throttle grip returns properly when released, otherwise an accident or injury could result.

## Adjusting the shock absorber assemblies

EAU14882

## **WARNING**

EWA10210

Always adjust both shock absorber assemblies equally, otherwise poor handling and loss of stability may result.

Each shock absorber assembly is equipped with a spring preload adjusting ring.

ECA10101

## **NOTICE**

To avoid damaging the mechanism, do not attempt to turn beyond the maximum or minimum settings.

Adjust the spring preload as follows. To increase the spring preload and thereby harden the suspension, turn the adjusting ring on each shock absorber assembly in direction (a). To decrease the spring preload and thereby soften the suspension, turn the adjusting ring on each shock absorber assembly in direction (b).

Align the appropriate notch in the adjusting ring with the position indicator on the shock absorber.

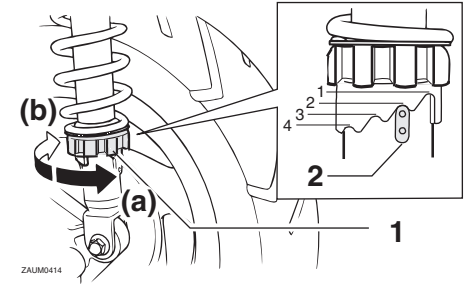

ZALUM0414

1. Spring preload adjusting ring
2. Position indicator

### Spring preload setting:

Minimum (soft):

1

Standard:

2

Maximum (hard):

4

# INSTRUMENT AND CONTROL FUNCTIONS

## Carrier

EAU15112

EWA10171

### WARNING

- Do not exceed the load limit of 5 kg (11 lb) for the carrier.
- Do not exceed the maximum load of 185 kg (408 lb) for the vehicle.

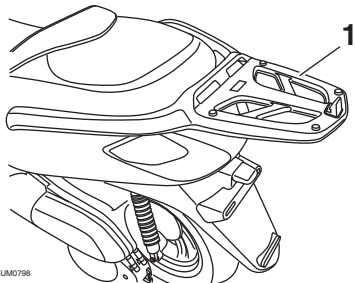

ZALIM0798

1. Carrier

## Luggage hook

EAU1072

EWAT1031

### WARNING

- Do not exceed the load limit of 3 kg (7 lb) for the luggage hook.
- Do not exceed the maximum load of 185 kg (408 lb) for the vehicle.

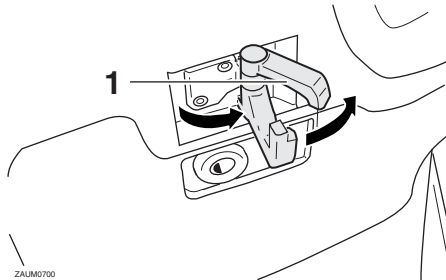

ZALIM0700

1. Luggage hook

## Sidestand

EAU15305

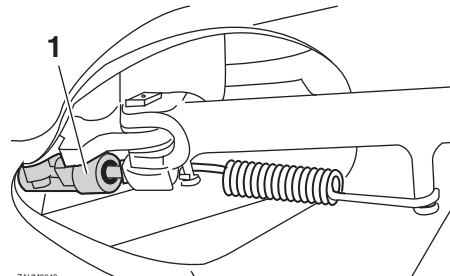

ZALIM0648

1. Sidestand switch

The sidestand is located on the left side of the frame. Raise the sidestand or lower it with your foot while holding the vehicle upright.

### TIP

The built-in sidestand switch is part of the ignition circuit cut-off system, which cuts the ignition in certain situations. (See the following section for an explanation of the ignition circuit cut-off system.)



## **WARNING**

EWA10241

The vehicle must not be ridden with the sidestand down, or if the sidestand cannot be properly moved up (or does not stay up), otherwise the sidestand could contact the ground and distract the operator, resulting in a possible loss of control. Yamaha's ignition circuit cut-off system has been designed to assist the operator in fulfilling the responsibility of raising the sidestand before starting off. Therefore, check this system regularly and have a Yamaha dealer repair it if it does not function properly.

EAU45052

## **Ignition circuit cut-off system**

The ignition circuit cut-off system (comprising the sidestand switch and brake light switches) has the following functions.

- It prevents starting when the sidestand is up, but neither brake is applied.
- It prevents starting when either brake is applied, but the sidestand is still down.
- It cuts the running engine when the sidestand is moved down.

Periodically check the operation of the ignition circuit cut-off system according to the following procedure.

# INSTRUMENT AND CONTROL FUNCTIONS

3

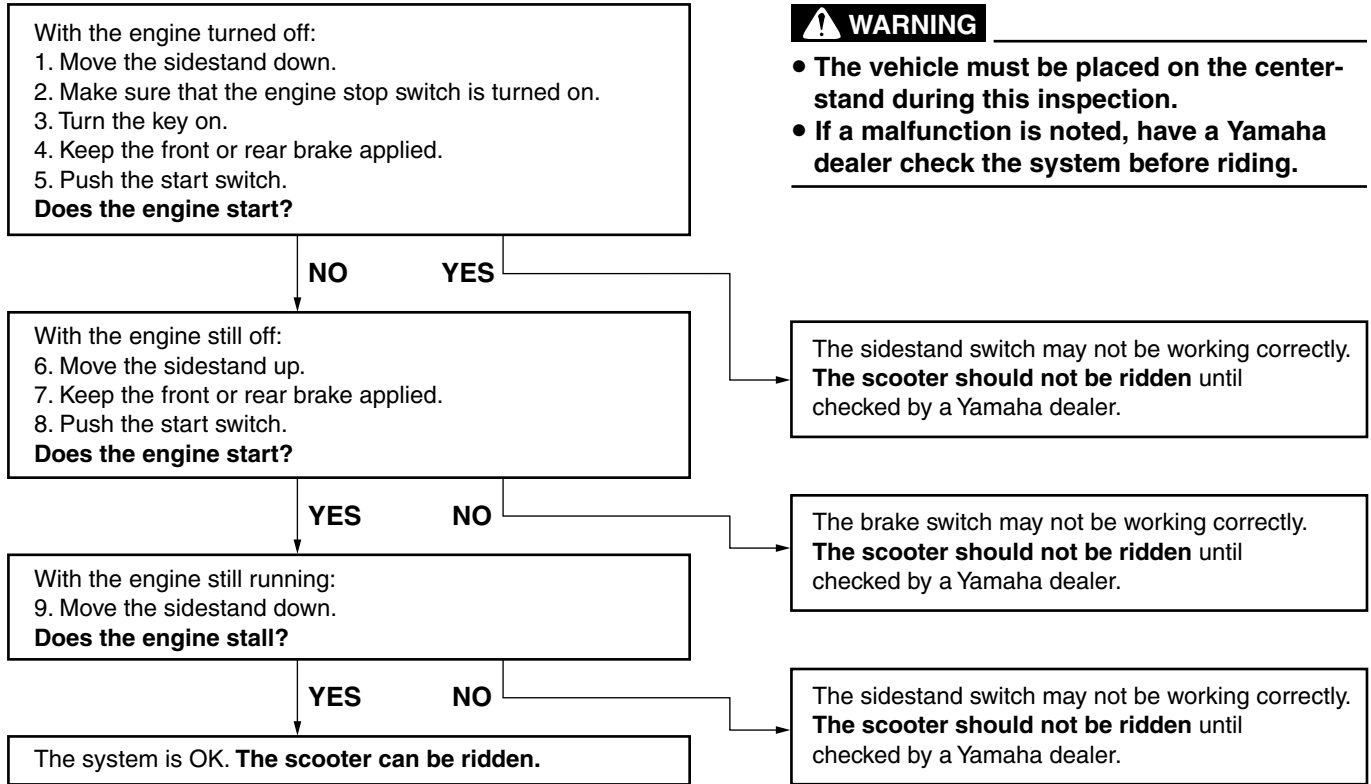

# FOR YOUR SAFETY – PRE-OPERATION CHECKS

EAU15596

Inspect your vehicle each time you use it to make sure the vehicle is in safe operating condition. Always follow the inspection and maintenance procedures and schedules described in the Owner's Manual.

EWA11151

## **WARNING**

**Failure to inspect or maintain the vehicle properly increases the possibility of an accident or equipment damage. Do not operate the vehicle if you find any problem. If a problem cannot be corrected by the procedures provided in this manual, have the vehicle inspected by a Yamaha dealer.**

Before using this vehicle, check the following points:

ITEM	CHECKS	PAGE
<b>Fuel</b>	<ul style="list-style-type: none"><li>• Check fuel level in fuel tank.</li><li>• Refuel if necessary.</li><li>• Check fuel line for leakage.</li></ul>	3-10
<b>Engine oil</b>	<ul style="list-style-type: none"><li>• Check oil level in engine.</li><li>• If necessary, add recommended oil to specified level.</li><li>• Check vehicle for oil leakage.</li></ul>	6-10
<b>Final transmission oil</b>	<ul style="list-style-type: none"><li>• Check vehicle for oil leakage.</li></ul>	6-13
<b>Coolant</b>	<ul style="list-style-type: none"><li>• Check coolant level in reservoir.</li><li>• If necessary, add recommended coolant to specified level.</li><li>• Check cooling system for leakage.</li></ul>	6-14
<b>Front brake</b>	<ul style="list-style-type: none"><li>• Check operation.</li><li>• If soft or spongy, have Yamaha dealer bleed hydraulic system.</li><li>• Check brake pads for wear.</li><li>• Replace if necessary.</li><li>• Check fluid level in reservoir.</li><li>• If necessary, add specified brake fluid to specified level.</li><li>• Check hydraulic system for leakage.</li></ul>	6-19, 6-20, 6-21

# FOR YOUR SAFETY – PRE-OPERATION CHECKS

ITEM	CHECKS	PAGE
<b>Rear brake</b>	<ul style="list-style-type: none"> <li>• Check operation.</li> <li>• If soft or spongy, have Yamaha dealer bleed hydraulic system.</li> <li>• Check brake pads for wear.</li> <li>• Replace if necessary.</li> <li>• Check fluid level in reservoir.</li> <li>• If necessary, add specified brake fluid to specified level.</li> <li>• Check hydraulic system for leakage.</li> </ul>	6-19, 6-20, 6-21
<b>Throttle grip</b>	<ul style="list-style-type: none"> <li>• Make sure that operation is smooth.</li> <li>• Check throttle grip free play.</li> <li>• If necessary, have Yamaha dealer adjust throttle grip free play and lubricate cable and grip housing.</li> </ul>	6-16, 6-23
<b>Wheels and tires</b>	<ul style="list-style-type: none"> <li>• Check for damage.</li> <li>• Check tire condition and tread depth.</li> <li>• Check air pressure.</li> <li>• Correct if necessary.</li> </ul>	6-17, 6-19
<b>Brake levers</b>	<ul style="list-style-type: none"> <li>• Make sure that operation is smooth.</li> <li>• Lubricate lever pivoting points if necessary.</li> </ul>	6-23
<b>Centerstand, sidestand</b>	<ul style="list-style-type: none"> <li>• Make sure that operation is smooth.</li> <li>• Lubricate pivots if necessary.</li> </ul>	6-23
<b>Chassis fasteners</b>	<ul style="list-style-type: none"> <li>• Make sure that all nuts, bolts and screws are properly tightened.</li> <li>• Tighten if necessary.</li> </ul>	—
<b>Instruments, lights, signals and switches</b>	<ul style="list-style-type: none"> <li>• Check operation.</li> <li>• Correct if necessary.</li> </ul>	—
<b>Sidestand switch</b>	<ul style="list-style-type: none"> <li>• Check operation of ignition circuit cut-off system.</li> <li>• If system is not working correctly, have Yamaha dealer check vehicle.</li> </ul>	3-16

# OPERATION AND IMPORTANT RIDING POINTS

EAU15951

Read the Owner's Manual carefully to become familiar with all controls. If there is a control or function you do not understand, ask your Yamaha dealer.

EWA10271



**Failure to familiarize yourself with the controls can lead to loss of control, which could cause an accident or injury.**

EAU45310

## TIP

This model is equipped with a lean angle sensor to stop the engine in case of a turnover. To start the engine after a turnover, be sure to turn the main switch to "OFF" and then to "ON". Failing to do so will prevent the engine from starting even though the engine will crank when pushing the start switch.

EAUM2233

## Starting the engine

ECA10250

### NOTICE

**See page 5-4 for engine break-in instructions prior to operating the vehicle for the first time.**

In order for the ignition circuit cut-off system to enable starting, the side-stand must be up.

See page 3-17 for more information.

1. Turn the key to "ON".

The following warning lights and indicator light should come on for a few seconds, then go off.

- Fuel level warning light
- Engine trouble warning light
- Immobilizer system indicator light

ECA11833

### NOTICE

**If a warning or indicator light does not come on initially when the key is turned to "ON", or if a warning or indicator light remains on, see page 3-3 for the corresponding warning and indicator light circuit check.**

2. Close the throttle completely.

# OPERATION AND IMPORTANT RIDING POINTS

3. Start the engine by pushing the start switch while applying the front or rear brake.

If the engine does not start, release the start switch, wait a few seconds, and then try again. Each starting attempt should be as short as possible to preserve the battery. Do not crank the engine more than 10 seconds on any one attempt. If the engine does not start, try with the throttle open 1/8 turn.

## NOTICE

**For maximum engine life, never accelerate hard when the engine is cold!**

ECA11042

## Starting off

EAU16761

### TIP

Before starting off, allow the engine to warm up.

1. While pulling the rear brake lever with your left hand and holding the grab bar with your right hand, push the scooter off the centerstand.

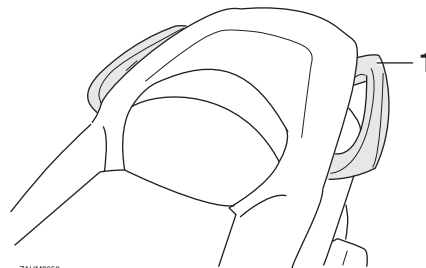

ZALUM0660

1. Grab bar

2. Sit astride the seat, and then adjust the rear view mirrors.
3. Switch the turn signals on.
4. Check for oncoming traffic, and then slowly turn the throttle grip (on the right) in order to take off.
5. Switch the turn signals off.

5

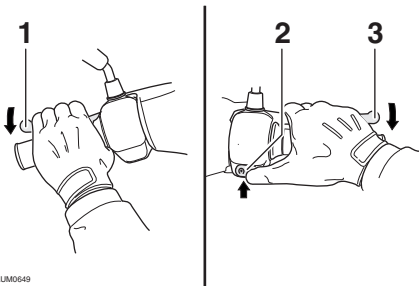

ZALUM0649

1. Rear brake lever
2. Start switch
3. Front brake lever

# OPERATION AND IMPORTANT RIDING POINTS

## Acceleration and deceleration

EAU16780

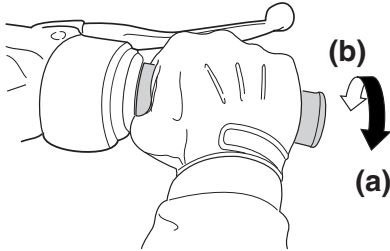

ZALUM0199

The speed can be adjusted by opening and closing the throttle. To increase the speed, turn the throttle grip in direction (a). To reduce the speed, turn the throttle grip in direction (b).

## Braking

EAU16793

EWA10300

### **⚠ WARNING**

- Avoid braking hard or suddenly (especially when leaning over to one side), otherwise the scooter may skid or overturn.
  - Railroad crossings, streetcar rails, iron plates on road construction sites, and manhole covers become extremely slippery when wet. Therefore, slow down when approaching such areas and cross them with caution.
  - Keep in mind that braking on a wet road is much more difficult.
  - Ride slowly down a hill, as braking downhill can be very difficult.
- 
1. Close the throttle completely.
  2. Apply both front and rear brakes simultaneously while gradually increasing the pressure.

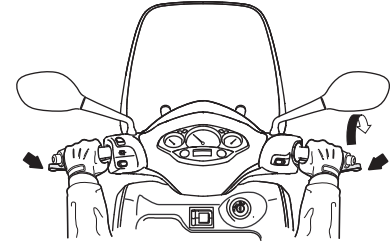

ZALUM0651

# OPERATION AND IMPORTANT RIDING POINTS

---

## Tips for reducing fuel consumption

EAU16820

Fuel consumption depends largely on your riding style. Consider the following tips to reduce fuel consumption:

- Avoid high engine speeds during acceleration.
- Avoid high engine speeds with no load on the engine.
- Turn the engine off instead of letting it idle for an extended length of time (e.g., in traffic jams, at traffic lights or at railroad crossings).

## Engine break-in

EAU16830

There is never a more important period in the life of your engine than the period between 0 and 1000 km (600 mi). For this reason, you should read the following material carefully.

Since the engine is brand new, do not put an excessive load on it for the first 1000 km (600 mi). The various parts in the engine wear and polish themselves to the correct operating clearances. During this period, prolonged full-throttle operation or any condition that might result in engine overheating must be avoided.

EAUM2281

### 0–500 km (0–300 mi)

Avoid prolonged operation above 1/3 throttle.

### 500–1000 km (300–600 mi)

Avoid prolonged operation above 1/2 throttle. **NOTICE: After 1000 km (600 mi) of operation, the engine oil and final transmission oil must be changed, and the engine oil filter element replaced.** [ECAM1091]

## 1000 km (600 mi) and beyond

The vehicle can now be operated normally.

ECA10270

### **NOTICE**

**If any engine trouble should occur during the engine break-in period, immediately have a Yamaha dealer check the vehicle.**



EAU17213

## Parking

When parking, stop the engine, and then remove the key from the main switch.

EWA10311

### **WARNING**

- Since the engine and exhaust system can become very hot, park in a place where pedestrians or children are not likely to touch them and be burned.
  - Do not park on a slope or on soft ground, otherwise the vehicle may overturn, increasing the risk of a fuel leak and fire.
  - Do not park near grass or other flammable materials which might catch fire.
-

# PERIODIC MAINTENANCE AND ADJUSTMENT

---

EAU17244

EWA15122

EAU17302

Periodic inspection, adjustment, and lubrication will keep your vehicle in the safest and most efficient condition possible. Safety is an obligation of the vehicle owner/operator. The most important points of vehicle inspection, adjustment, and lubrication are explained on the following pages.

The intervals given in the periodic maintenance charts should be simply considered as a general guide under normal riding conditions. However, depending on the weather, terrain, geographical location, and individual use, the maintenance intervals may need to be shortened.

6

## WARNING

EWA10321

**Failure to properly maintain the vehicle or performing maintenance activities incorrectly may increase your risk of injury or death during service or while using the vehicle. If you are not familiar with vehicle service, have a Yamaha dealer perform service.**

---

## WARNING

**Turn off the engine when performing maintenance unless otherwise specified.**

- **A running engine has moving parts that can catch on body parts or clothing and electrical parts that can cause shocks or fires.**
- **Running the engine while servicing can lead to eye injury, burns, fire, or carbon monoxide poisoning – possibly leading to death. See page 1-3 for more information about carbon monoxide.**

EWA15460

## WARNING

**Brake discs, calipers, drums, and linings can become very hot during use. To avoid possible burns, let brake components cool before touching them.**

---

Emission controls not only function to ensure cleaner air, but are also vital to proper engine operation and maximum performance. In the following periodic maintenance charts, the services related to emissions control are grouped separately. These services require specialized data, knowledge, and equipment. Maintenance, replacement, or repair of the emission control devices and systems may be performed by any repair establishment or individual that is certified (if applicable). Yamaha dealers are trained and equipped to perform these particular services.

EAU17471

## Owner's tool kit

The owner's tool kit is located inside the rear storage compartment. (See page 3-13.)

The service information included in this manual and the tools provided in the owner's tool kit are intended to assist you in the performance of preventive maintenance and minor repairs. However, additional tools such as a torque wrench may be necessary to perform certain maintenance work correctly.

### **TIP** \_\_\_\_\_

If you do not have the tools or experience required for a particular job, have a Yamaha dealer perform it for you.

---

# PERIODIC MAINTENANCE AND ADJUSTMENT

EAU46871

## TIP

- The annual checks must be performed every year, except if a kilometer-based maintenance, or for the UK, a mileage-based maintenance, is performed instead.
- From 30000 km (17500 mi), repeat the maintenance intervals starting from 6000 km (3500 mi).
- Items marked with an asterisk should be performed by a Yamaha dealer as they require special tools, data and technical skills.

EAU46920

## Periodic maintenance chart for the emission control system

NO.	ITEM	CHECK OR MAINTENANCE JOB	ODOMETER READING					ANNUAL CHECK
			1000 km (600 mi)	6000 km (3500 mi)	12000 km (7000 mi)	18000 km (10500 mi)	24000 km (14000 mi)	
1	* Fuel line	<ul style="list-style-type: none"> <li>• Check fuel hoses for cracks or damage.</li> </ul>		√	√	√	√	√
2	Spark plug	<ul style="list-style-type: none"> <li>• Check condition.</li> <li>• Clean and regap.</li> </ul>		√		√		
		<ul style="list-style-type: none"> <li>• Replace.</li> </ul>			√		√	
3	* Valves	<ul style="list-style-type: none"> <li>• Check valve clearance.</li> <li>• Adjust.</li> </ul>		√	√	√	√	
4	* Fuel injection	<ul style="list-style-type: none"> <li>• Check engine idle speed.</li> </ul>	√	√	√	√	√	√
5	* Muffler and exhaust pipe	<ul style="list-style-type: none"> <li>• Check the screw clamp(s) for looseness.</li> </ul>	√	√	√	√	√	

# PERIODIC MAINTENANCE AND ADJUSTMENT

EAU17717

## General maintenance and lubrication chart

NO.	ITEM	CHECK OR MAINTENANCE JOB	ODOMETER READING					ANNUAL CHECK
			1000 km (600 mi)	6000 km (3500 mi)	12000 km (7000 mi)	18000 km (10500 mi)	24000 km (14000 mi)	
1	* Air filter element	• Replace.			√		√	
2	V-belt case air filter element	• Clean.		√	√	√	√	
3	* Front brake	• Check operation, fluid level and vehicle for fluid leakage.	√	√	√	√	√	√
		• Replace brake pads.	Whenever worn to the limit					
4	* Rear brake	• Check operation, fluid level and vehicle for fluid leakage.	√	√	√	√	√	√
		• Replace brake pads.	Whenever worn to the limit					
5	* Brake hoses	• Check for cracks or damage. • Check for correct routing and clamping.		√	√	√	√	√
		• Replace.	Every 4 years					
6	* Wheels	• Check runout and for damage.		√	√	√	√	
7	* Tires	• Check tread depth and for damage. • Replace if necessary. • Check air pressure. • Correct if necessary.		√	√	√	√	√
8	* Wheel bearings	• Check bearing for looseness or damage.		√	√	√	√	

# PERIODIC MAINTENANCE AND ADJUSTMENT

NO.	ITEM	CHECK OR MAINTENANCE JOB	ODOMETER READING					ANNUAL CHECK
			1000 km (600 mi)	6000 km (3500 mi)	12000 km (7000 mi)	18000 km (10500 mi)	24000 km (14000 mi)	
9	* Steering bearings	• Check bearing play and steering for roughness.	√	√	√	√	√	
		• Lubricate with lithium-soap-based grease.	Every 24000 km (14000 mi)					
10	* Chassis fasteners	• Make sure that all nuts, bolts and screws are properly tightened.		√	√	√	√	√
11	Front brake lever pivot shaft	• Lubricate with silicone grease.		√	√	√	√	√
12	Rear brake lever pivot shaft	• Lubricate with silicone grease.		√	√	√	√	√
13	Sidestand, center-stand	• Check operation. • Lubricate with lithium-soap-based grease.		√	√	√	√	√
14	* Sidestand switch	• Check operation.	√	√	√	√	√	√
15	* Front fork	• Check operation and for oil leakage.		√	√	√	√	
16	* Shock absorber assemblies	• Check operation and shock absorbers for oil leakage.		√	√	√	√	
17	Engine oil	• Change. (See page 3-3.)	√	When the oil change indicator light comes on [5000 km (3000 mi) after the initial 1000 km (600 mi) and every 6000 km (3500 mi) thereafter]				
		• Check oil level and vehicle for oil leakage.	Every 3000 km (1800 mi)					√
18	Engine oil filter element	• Replace.	√		√		√	

# PERIODIC MAINTENANCE AND ADJUSTMENT

NO.	ITEM	CHECK OR MAINTENANCE JOB	ODOMETER READING					ANNUAL CHECK
			1000 km (600 mi)	6000 km (3500 mi)	12000 km (7000 mi)	18000 km (10500 mi)	24000 km (14000 mi)	
19	* Cooling system	• Check coolant level and vehicle for coolant leakage.		√	√	√	√	√
		• Change coolant.	Every 3 years					
20	Final transmission oil	• Check vehicle for oil leakage.	√	√		√		
		• Change.	√		√		√	
21	* V-belt	• Replace.	Every 18000 km (10500 mi)					
22	* Front and rear brake switches	• Check operation.	√	√	√	√	√	√
23	Moving parts and cables	• Lubricate.		√	√	√	√	√
24	* Throttle grip	• Check operation. • Check throttle grip free play, and adjust if necessary. • Lubricate cable and grip housing.		√	√	√	√	√
25	* Lights, signals and switches	• Check operation. • Adjust headlight beam.	√	√	√	√	√	√

EAU18670

## TIP

- The air filter needs more frequent service if you are riding in unusually wet or dusty areas.
- Hydraulic brake service
  - Regularly check and, if necessary, correct the brake fluid level.
  - Every two years replace the internal components of the brake master cylinders and calipers, and change the brake fluid.

## **PERIODIC MAINTENANCE AND ADJUSTMENT**

---

---

- Replace the brake hoses every four years and if cracked or damaged.
-



# PERIODIC MAINTENANCE AND ADJUSTMENT

## Removing and installing cowlings and panels EAU18712

The cowlings and panels shown need to be removed to perform some of the maintenance jobs described in this chapter. Refer to this section each time a cowling or panel needs to be removed and installed.

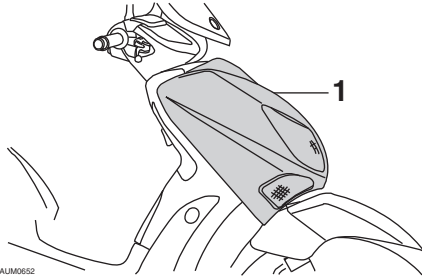

1. Cowling A

ZAUIM0652

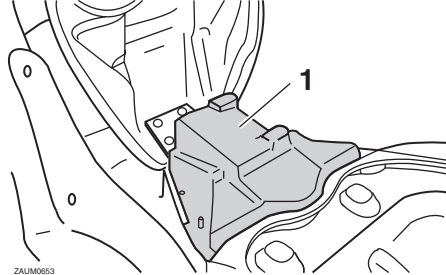

1. Panel A

ZAUIM0653

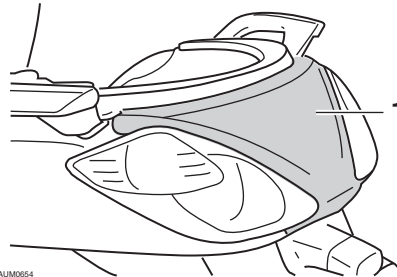

1. Panel B

ZAUIM0654

## Cowling A

EAUM2221

### To remove the cowling

1. Remove the cowling screws.

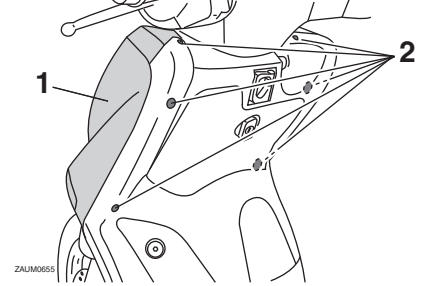

1. Cowling A

2. Screw

ZAUIM0655

2. Disconnect the headlight coupler and the turn signal couplers.

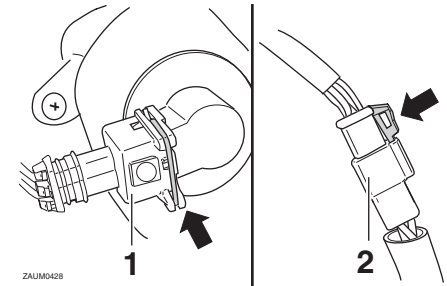

1. Turn signal light lead coupler

2. Headlight coupler

ZAUIM0428

3. Pull the cowling off.

# PERIODIC MAINTENANCE AND ADJUSTMENT

## To install the cowling

1. Connect the headlight coupler and the turn signal couplers.
2. Place the cowling in the original position, and then install the screws.

## Panel A

EAU19482

## To remove the panel

1. Open the seat. (See page 3-12.)
2. Remove the screws, and then pull the panel off as shown.

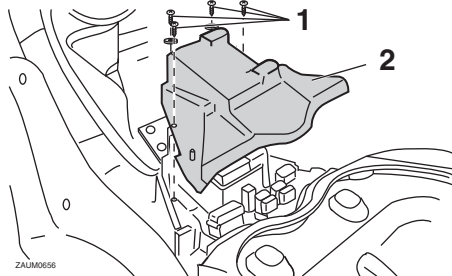

1. Screw
2. Panel A

## To install the panel

Place the panel in the original position, and then install the screws.

## Panel B

EAU19210

## To remove the panel

Remove the screws, and then take the panel off.

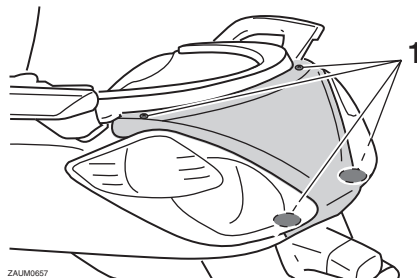

1. Screw

## To install the panel

Place the panel in the original position, and then install the screws.

## Checking the spark plug

EAU19622

The spark plug is an important engine component, which should be checked periodically, preferably by a Yamaha dealer. Since heat and deposits will cause any spark plug to slowly erode, it should be removed and checked in accordance with the periodic maintenance and lubrication chart. In addition, the condition of the spark plug can reveal the condition of the engine.

The porcelain insulator around the center electrode of the spark plug should be a medium-to-light tan (the ideal color when the vehicle is ridden normally). If the spark plug shows a distinctly different color, the engine could be operating improperly. Do not attempt to diagnose such problems yourself. Instead, have a Yamaha dealer check the vehicle. If the spark plug shows signs of electrode erosion and excessive carbon or other deposits, it should be replaced.

**Specified spark plug:**  
NGK/CPR9EA-9

# PERIODIC MAINTENANCE AND ADJUSTMENT

EAUM2271

Before installing a spark plug, the spark plug gap should be measured with a wire thickness gauge and, if necessary, adjusted to specification.

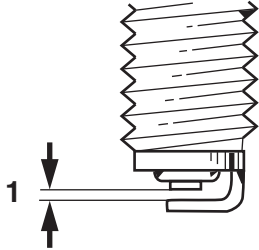

ZAJM0037

1. Spark plug gap

## Spark plug gap:

0.8–0.9 mm (0.031–0.035 in)

Clean the surface of the spark plug gasket and its mating surface, and then wipe off any grime from the spark plug threads.

## Tightening torque:

Spark plug:

12.5 Nm (1.25 m·kgf, 9.0 ft·lbf)

**TIP** \_\_\_\_\_  
If a torque wrench is not available when installing a spark plug, a good estimate of the correct torque is 1/4–1/2 turn past finger tight. However, the spark plug should be tightened to the specified torque as soon as possible.

## Engine oil

The engine oil level should be checked before each ride. In addition, the oil must be changed at the intervals specified in the periodic maintenance and lubrication chart and when the service indicator light comes on.

### To check the engine oil level

1. Place the scooter on the center-stand. A slight tilt to the side can result in a false reading.
2. Start the engine, warm it up for several minutes, and then turn it off.
3. Wait a few minutes until the oil settles, remove the oil filler cap, wipe the dipstick clean, insert it back into the oil filler hole (without screwing it in), and then remove it again to check the oil level.

### TIP

\_\_\_\_\_The engine oil should be between the minimum and maximum level marks.

# PERIODIC MAINTENANCE AND ADJUSTMENT

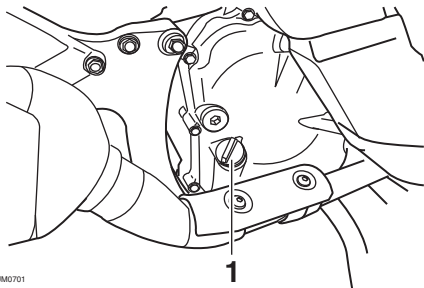

ZALUM0701

1. Engine oil filler cap

4. If the engine oil is below the minimum level mark, add sufficient oil of the recommended type to raise it to the correct level.
5. Insert the dipstick into the oil filler hole, and then tighten the oil filler cap.

6

## To change the engine oil (with or without oil filter element replacement)

1. Start the engine, warm it up for several minutes, and then turn it off.
2. Place an oil pan under the engine to collect the used oil.

3. Remove the engine oil filler cap and the engine oil drain bolt to drain the oil from the crankcase.

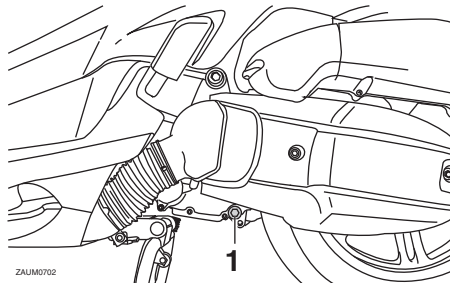

ZALUM0702

1. Engine oil drain bolt

4. Check the drain bolt washer for damage and replace it if necessary.

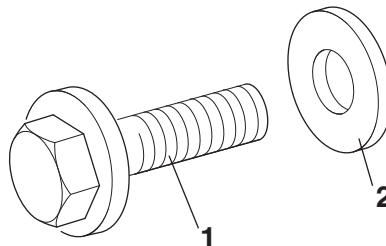

ZALUM0129

1. Engine oil drain bolt  
2. Washer

## TIP

Skip steps 5–9 if the oil filter element is not being replaced.

5. Remove the oil filter element cover by removing the bolts.

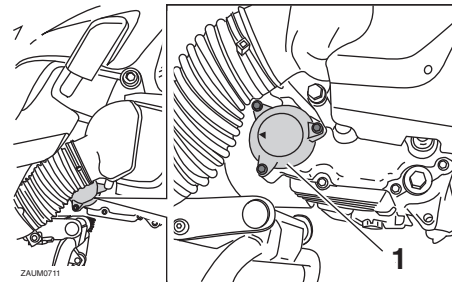

ZALUM0711

1. Oil filter element cover

6. Remove the oil filter element and O-ring.

# PERIODIC MAINTENANCE AND ADJUSTMENT

ECA11670

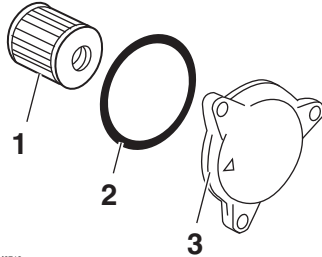

ZAJUM0712

1. Oil filter element
2. O-ring
3. Oil filter element cover

7. Check the O-ring for damage and replace it if necessary.
8. Install the new oil filter element and an O-ring.
9. Install the oil filter element cover by installing the bolts, then tightening them to the specified torque.

### Tightening torque:

Oil filter cover bolt:  
10 Nm (1.0 m·kgf, 7.2 ft·lbf)

### TIP

Make sure that the O-ring is properly seated.

10. Install the washer and the engine oil drain bolt, and then tighten the drain bolt to the specified torque.

### Tightening torque:

Engine oil drain bolt:  
20 Nm (2.0 m·kgf, 14 ft·lbf)

### TIP

Make sure that the washer is properly seated.

11. Refill with the specified amount of the recommended engine oil, and then install and tighten the oil filler cap.

### Recommended engine oil:

See page 8-1.

### Oil change quantity:

Without oil filter element replacement:

1.40 L (1.48 US qt, 1.23 Imp.qt)

With oil filter element replacement:

1.50 L (1.59 US qt, 1.32 Imp.qt)

### TIP

Be sure to wipe off spilled oil on any parts after the engine and exhaust system have cooled down.

### NOTICE

- Do not use oils with a diesel specification of “CD” or oils of a higher quality than specified. In addition, do not use oils labeled “ENERGY CONSERVING II” or higher.
- Be sure no foreign material enters the crankcase.

12. Start the engine, and then let it idle for several minutes while checking it for oil leakage. If oil is leaking, immediately turn the engine off and check for the cause.
13. Turn the engine off, and then check the oil level and correct it if necessary.
14. Reset the oil change indicator. (See page 3-8.)

# PERIODIC MAINTENANCE AND ADJUSTMENT

EAU20066

## Final transmission oil

The final transmission case must be checked for oil leakage before each ride. If any leakage is found, have a Yamaha dealer check and repair the scooter. In addition, the final transmission oil must be changed as follows at the intervals specified in the periodic maintenance and lubrication chart.

1. Start the engine, warm up the final transmission oil by riding the scooter for several minutes, and then stop the engine.
2. Place the scooter on the center-stand.
3. Place an oil pan under the final transmission case to collect the used oil.
4. Remove the final transmission oil filler cap and its O-ring from the final transmission case.

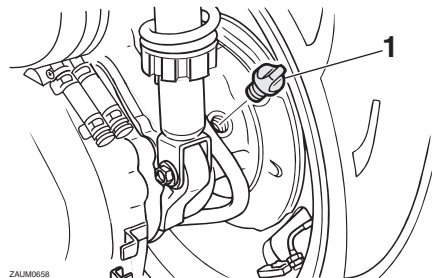

ZALJM0658

1. Final transmission oil filler cap

5. Remove the final transmission oil drain bolt and its gasket to drain the oil from the final transmission case.

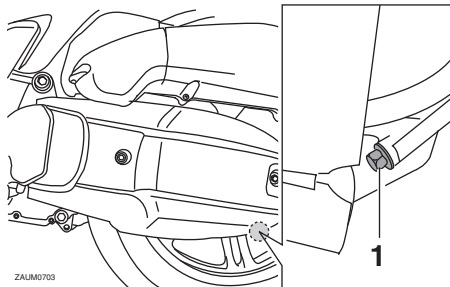

ZALJM0703

1. Final transmission oil drain bolt

6. Install the final transmission oil drain bolt and its new gasket, and then tighten the bolt to the specified torque.

### Tightening torque:

Final transmission oil drain bolt:  
20 Nm (2.0 m·kgf, 14 ft·lbf)

7. Refill with the specified amount of the recommended final transmission oil. **WARNING! Make sure that no foreign material enters the final transmission case. Make sure that no oil gets on the tire or wheel.** [EWA11311]

### Recommended final transmission oil:

See page 8-1.

### Oil quantity:

0.21 L (0.22 US qt, 0.18 Imp.qt)

8. Install the final transmission oil filler cap and its new O-ring, and then tighten the oil filler cap.
9. Check the final transmission case for oil leakage. If oil is leaking, check for the cause.

# PERIODIC MAINTENANCE AND ADJUSTMENT

## Coolant

EAU20070

The coolant level should be checked before each ride. In addition, the coolant must be changed at the intervals specified in the periodic maintenance and lubrication chart.

EAUM2102

### To check the coolant level

1. Place the vehicle on a level surface and hold it in an upright position.

### TIP

- The coolant level must be checked on a cold engine since the level varies with engine temperature.
- Make sure that the vehicle is positioned straight up when checking the coolant level. A slight tilt to the side can result in a false reading.

2. Check the coolant level through the check window.

### TIP

The coolant should be between the minimum and maximum level marks.

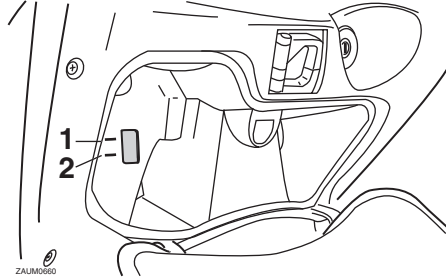

1. Maximum level mark
2. Minimum level mark

3. If the coolant is at or below the minimum level mark, remove the cowling A. (See page 6-8.)
4. Open the reservoir cap, and then add coolant to the maximum level mark. **WARNING! Remove only the coolant reservoir cap. Never attempt to remove the radiator cap when the engine is hot.**

[EWA15161] **NOTICE:** If coolant is not available, use distilled water or soft tap water instead. Do not use hard water or salt water since it is harmful to the engine. If water has been used instead of coolant, replace it with coolant as soon as possible, other-

wise the cooling system will not be protected against frost and corrosion. If water has been added to the coolant, have a Yamaha dealer check the anti-freeze content of the coolant as soon as possible, otherwise the effectiveness of the coolant will be reduced. [ECA10472]

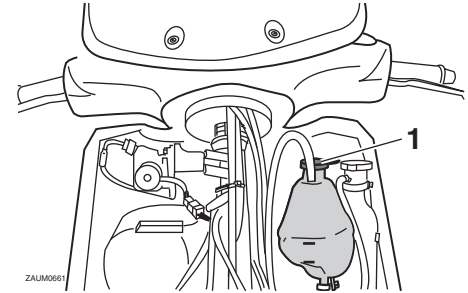

1. Coolant reservoir cap

**Coolant reservoir capacity:**  
0.20 L (0.21 US qt, 0.18 Imp.qt)

5. Close the reservoir cap, and then install the cowling.

# PERIODIC MAINTENANCE AND ADJUSTMENT

## Changing the coolant

EAU33031

The coolant must be changed at the intervals specified in the periodic maintenance and lubrication chart. Have a Yamaha dealer change the coolant.

**WARNING! Never attempt to remove the radiator cap when the engine is hot.** [EWA10381]

## Air filter and V-belt case air filter elements

EAUM2242

The air filter element should be replaced and the V-belt case air filter element should be cleaned at the intervals specified in the periodic maintenance and lubrication chart. Service the air filter elements more frequently if you are riding in unusually wet or dusty areas.

### Replacing the air filter element

1. Place the scooter on the center-stand.
2. Remove the air filter case cover by removing the screws.

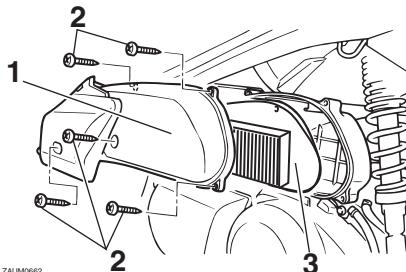

ZALUM0682

1. Air filter case cover
2. Screw
3. Air filter element

3. Pull the air filter element out.
4. Insert a new air filter element into the air filter case.
5. Install the air filter case cover by installing the screws.

### Cleaning the V-belt case air filter element

1. Remove the V-belt case air filter covers by removing the screws.

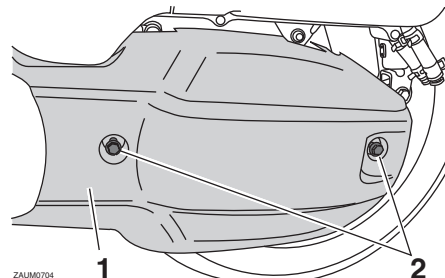

ZALUM0704

1. V-belt case air filter cover
2. Screw



# PERIODIC MAINTENANCE AND ADJUSTMENT

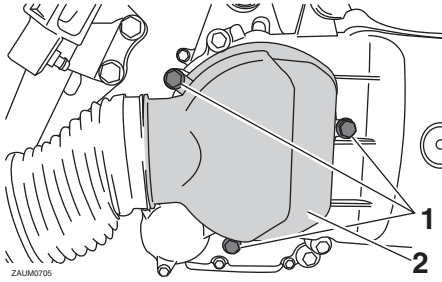

1. Screw
2. V-belt case air filter cover

2. Remove the air filter element, and then blow out the dirt with compressed air as shown.

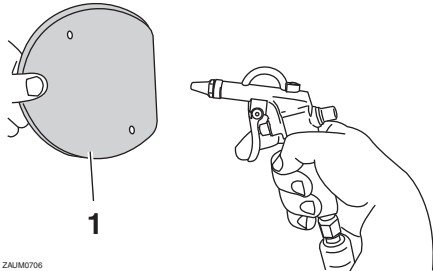

1. V-belt case air filter element

3. Check the air filter element for damage and replace it if necessary.

4. Install the air filter element with the colored side facing outward.
5. Install the V-belt case air filter covers by installing the screws. **NOTICE:** Make sure that each filter element is properly seated in its case. The engine should never be operated without the filter elements installed, otherwise the piston(s) and/or cylinder(s) may become excessively worn.

[ECA10531]

## Checking the throttle grip free play

EAU21384

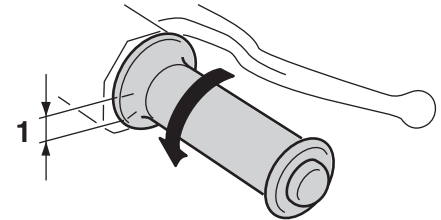

ZAJM0051

1. Throttle grip free play

The throttle grip free play should measure 3.0–5.0 mm (0.12–0.20 in) at the inner edge of the throttle grip. Periodically check the throttle grip free play and, if necessary, have a Yamaha dealer adjust it.

# PERIODIC MAINTENANCE AND ADJUSTMENT

EAU21401

## Valve clearance

The valve clearance changes with use, resulting in improper air-fuel mixture and/or engine noise. To prevent this from occurring, the valve clearance must be adjusted by a Yamaha dealer at the intervals specified in the periodic maintenance and lubrication chart.

EAUM2044

## Tires

Tires are the only contact between the vehicle and the road. Safety in all conditions of riding depends on a relatively small area of road contact. Therefore, it is essential to maintain the tires in good condition at all times and replace them at the appropriate time with the specified tires.

## Tire air pressure

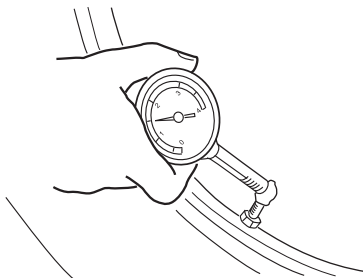

ZALM0053

The tire air pressure should be checked and, if necessary, adjusted before each ride.

EWA10503

## **! WARNING**

Operation of this vehicle with improper tire pressure may cause severe injury or death from loss of control.

- The tire air pressure must be checked and adjusted on cold tires (i.e., when the temperature of the tires equals the ambient temperature).
- The tire air pressure must be adjusted in accordance with the riding speed and with the total weight of rider, passenger, cargo, and accessories approved for this model.

# PERIODIC MAINTENANCE AND ADJUSTMENT

## Tire air pressure (measured on cold tires):

### 0–90 kg (0–198 lb):

Front:

170 kPa (1.70 kgf/cm<sup>2</sup>, 25 psi)

Rear:

190 kPa (1.90 kgf/cm<sup>2</sup>, 28 psi)

### 90–185 kg (198–408 lb):

Front:

180 kPa (1.80 kgf/cm<sup>2</sup>, 26 psi)

Rear:

200 kPa (2.00 kgf/cm<sup>2</sup>, 29 psi)

## Maximum load\*:

185 kg (408 lb)

\* Total weight of rider, passenger, cargo and accessories

EWA10511



## WARNING

**Never overload your vehicle. Operation of an overloaded vehicle could cause an accident.**

## Tire inspection

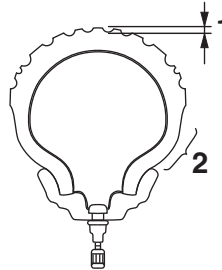

ZAUM0054

1. Tire tread depth
2. Tire sidewall

The tires must be checked before each ride. If the center tread depth reaches the specified limit, if the tire has a nail or glass fragments in it, or if the sidewall is cracked, have a Yamaha dealer replace the tire immediately.

**Minimum tire tread depth (front and rear):**  
1.6 mm (0.06 in)

## TIP

The tire tread depth limits may differ from country to country. Always comply with the local regulations.

## Tire information

This model is equipped with tubeless tires.

Tires age, even if they have not been used or have only been used occasionally. Cracking of the tread and sidewall rubber, sometimes accompanied by carcass deformation, is an evidence of ageing. Old and aged tires shall be checked by tire specialists to ascertain their suitability for further use.

After extensive tests, only the tires listed below have been approved for this model by Yamaha Motor Co., Ltd.

### Front tire:

Size:

120/70-16 M/C 57P

Manufacturer/model:

PIRELLI/SPORT DEMON  
FRONT

### Rear tire:

Size:

140/70-15 M/C 69P

Manufacturer/model:

PIRELLI/SPORT DEMON

# PERIODIC MAINTENANCE AND ADJUSTMENT

## **WARNING**

EWA10471

- Have a Yamaha dealer replace excessively worn tires. Besides being illegal, operating the vehicle with excessively worn tires decreases riding stability and can lead to loss of control.
- The replacement of all wheel and brake-related parts, including the tires, should be left to a Yamaha dealer, who has the necessary professional knowledge and experience to do so.
- Ride at moderate speeds after changing a tire since the tire surface must first be “broken in” for it to develop its optimal characteristics.

## Cast wheels

EAU21962

To maximize the performance, durability, and safe operation of your vehicle, note the following points regarding the specified wheels.

- The wheel rims should be checked for cracks, bends, warpage or other damage before each ride. If any damage is found, have a Yamaha dealer replace the wheel. Do not attempt even the smallest repair to the wheel. A deformed or cracked wheel must be replaced.
- The wheel should be balanced whenever either the tire or wheel has been changed or replaced. An unbalanced wheel can result in poor performance, adverse handling characteristics, and a shortened tire life.

EAU33453

## Front and rear brake lever free play

### Front

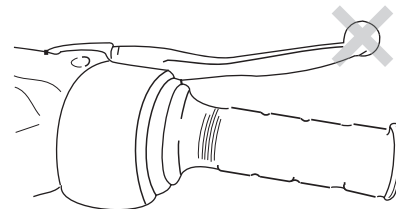

ZAJM0687

### Rear

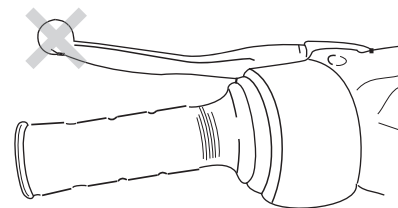

ZAJM0688

There should be no free play at the brake lever ends. If there is free play, have a Yamaha dealer inspect the brake system.

# PERIODIC MAINTENANCE AND ADJUSTMENT

## WARNING

EWA14211

A soft or spongy feeling in the brake lever can indicate the presence of air in the hydraulic system. If there is air in the hydraulic system, have a Yamaha dealer bleed the system before operating the vehicle. Air in the hydraulic system will diminish the braking performance, which may result in loss of control and an accident.

## Checking the front and rear brake pads

EAU22392

The front and rear brake pads must be checked for wear at the intervals specified in the periodic maintenance and lubrication chart.

### Front brake pads

EAU22420

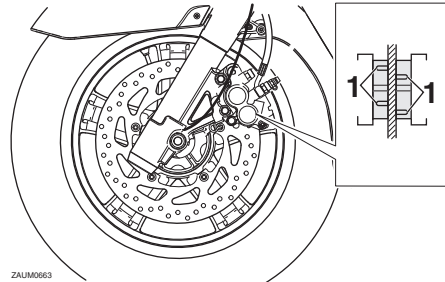

ZAUM0663

1. Brake pad wear indicator groove

Each front brake pad is provided with a wear indicator groove, which allows you to check the brake pad wear without having to disassemble the brake. To check the brake pad wear, check the wear indicator groove. If a brake pad has worn to the point that the wear

indicator groove has almost disappeared, have a Yamaha dealer replace the brake pads as a set.

### Rear brake pads

EAU22500

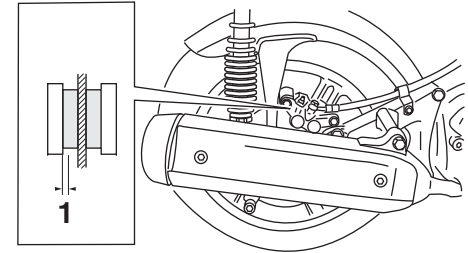

ZAUM0664

1. Lining thickness

Check each rear brake pad for damage and measure the lining thickness. If a brake pad is damaged or if the lining thickness is less than 0.8 mm (0.03 in), have a Yamaha dealer replace the brake pads as a set.

# PERIODIC MAINTENANCE AND ADJUSTMENT

## Checking the brake fluid level

EAU22581

Before riding, check that the brake fluid is above the minimum level mark. Check the brake fluid level with the top of the reservoir level. Replenish the brake fluid if necessary.

### Front brake

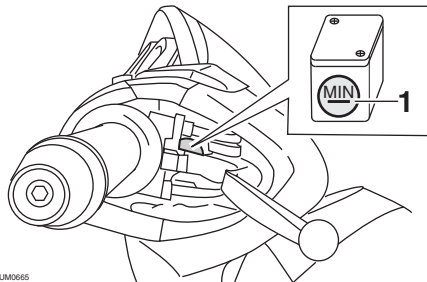

ZAUM0665

1. Minimum level mark

### Rear brake

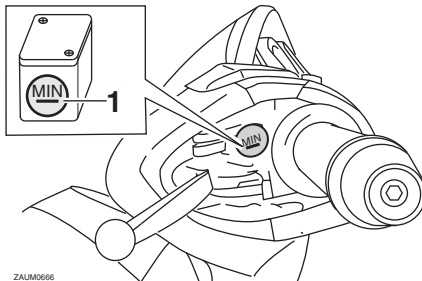

ZAUM0666

1. Minimum level mark

**Specified brake fluid:**  
DOT 4

EWA15990

### **WARNING**

Improper maintenance can result in loss of braking ability. Observe these precautions:

- Insufficient brake fluid may allow air to enter the brake system, reducing braking performance.
- Clean the filler cap before removing. Use only DOT 4 brake fluid from a sealed container.

- Use only the specified brake fluid; otherwise, the rubber seals may deteriorate, causing leakage.
- Refill with the same type of brake fluid. Adding a brake fluid other than DOT 4 may result in a harmful chemical reaction.
- Be careful that water does not enter the brake fluid reservoir when refilling. Water will significantly lower the boiling point of the fluid and may result in vapor lock.

ECA17640

### **NOTICE**

Brake fluid may damage painted surfaces or plastic parts. Always clean up spilled fluid immediately.

As the brake pads wear, it is normal for the brake fluid level to gradually go down. A low brake fluid level may indicate worn brake pads and/or brake system leakage; therefore, be sure to check the brake pads for wear and the brake system for leakage. If the brake

# PERIODIC MAINTENANCE AND ADJUSTMENT

fluid level goes down suddenly, have a Yamaha dealer check the cause before further riding.

## Changing the brake fluid

EAU22721

Have a Yamaha dealer change the brake fluid at the intervals specified in the TIP after the periodic maintenance and lubrication chart. In addition, have the oil seals of the brake master cylinder and caliper as well as the brake hose replaced at the intervals listed below or whenever they are damaged or leaking.

- Oil seals: Replace every two years.
- Brake hose: Replace every four years.

## Checking and lubricating the cables

EAU23095

The operation of all control cables and the condition of the cables should be checked before each ride, and the cables and cable ends should be lubricated if necessary. If a cable is damaged or does not move smoothly, have a Yamaha dealer check or replace it. **WARNING! Damage to the outer housing of cables may result in internal rusting and cause interference with cable movement. Replace damaged cables as soon as possible to prevent unsafe conditions.**

[EWA10711]

### Recommended lubricant:

Yamaha Chain and Cable Lube or engine oil

# PERIODIC MAINTENANCE AND ADJUSTMENT

6

## Checking and lubricating the throttle grip and cable

EAU23114

The operation of the throttle grip should be checked before each ride. In addition, the cable should be lubricated by a Yamaha dealer at the intervals specified in the periodic maintenance chart. The throttle cable is equipped with a rubber cover. Make sure that the cover is securely installed. Even though the cover is installed correctly, it does not completely protect the cable from water entry. Therefore, use care not to pour water directly onto the cover or cable when washing the vehicle. If the cable or cover becomes dirty, wipe clean with a moist cloth.

## Lubricating the front and rear brake levers

EAU23172

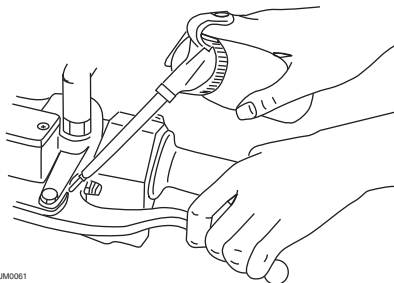

ZALJM061

The pivoting points of the front and rear brake levers must be lubricated at the intervals specified in the periodic maintenance and lubrication chart.

**Recommended lubricant:**  
Silicone grease

## Checking and lubricating the centerstand and sidestand

EAU23213

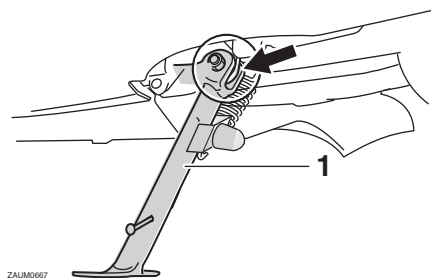

ZALJM067

1. Sidestand

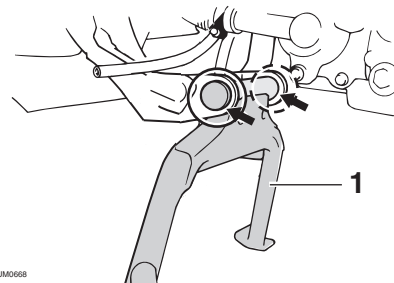

ZALJM068

1. Centerstand



# PERIODIC MAINTENANCE AND ADJUSTMENT

The operation of the centerstand and sidestand should be checked before each ride, and the pivots and metal-to-metal contact surfaces should be lubricated if necessary.

EWA10741

## WARNING

If the centerstand or sidestand does not move up and down smoothly, have a Yamaha dealer check or repair it. Otherwise, the centerstand or sidestand could contact the ground and distract the operator, resulting in a possible loss of control.

**Recommended lubricant:**  
Lithium-soap-based grease

## Checking the front fork

EAU23272

The condition and operation of the front fork must be checked as follows at the intervals specified in the periodic maintenance and lubrication chart.

### To check the condition

Check the inner tubes for scratches, damage and excessive oil leakage.

### To check the operation

1. Place the vehicle on a level surface and hold it in an upright position. **WARNING! To avoid injury, securely support the vehicle so there is no danger of it falling over.** [EWA10751]
2. While applying the front brake, push down hard on the handlebars several times to check if the front fork compresses and rebounds smoothly.

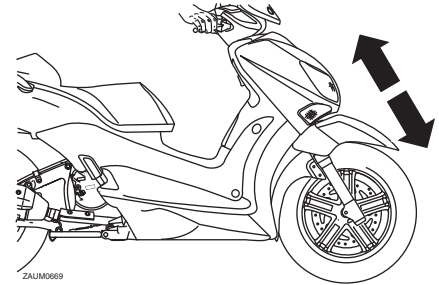

ECA10590

## NOTICE

If any damage is found or the front fork does not operate smoothly, have a Yamaha dealer check or repair it.

# PERIODIC MAINTENANCE AND ADJUSTMENT

EAU45511

## Checking the steering

Worn or loose steering bearings may cause danger. Therefore, the operation of the steering must be checked as follows at the intervals specified in the periodic maintenance and lubrication chart.

1. Place the vehicle on the centerstand. **WARNING! To avoid injury, securely support the vehicle so there is no danger of it falling over.** [EWA10751]
2. Hold the lower ends of the front fork legs and try to move them forward and backward. If any free play can be felt, have a Yamaha dealer check or repair the steering.

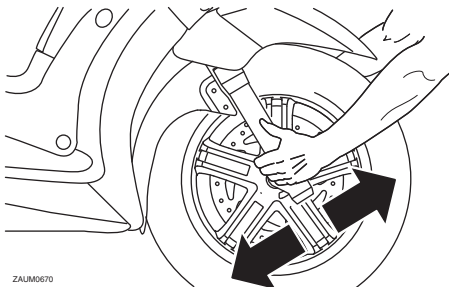

ZAUM0670

EAU23291

## Checking the wheel bearings

The front and rear wheel bearings must be checked at the intervals specified in the periodic maintenance and lubrication chart. If there is play in the wheel hub or if the wheel does not turn smoothly, have a Yamaha dealer check the wheel bearings.

EAU23396

## Battery

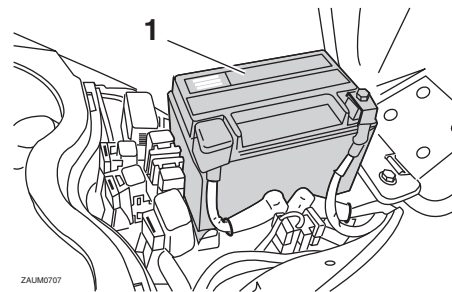

ZAUM0707

### 1. Battery

The battery is located behind panel A. (See page 6-8.)

This model is equipped with a VRLA (Valve Regulated Lead Acid) battery. There is no need to check the electrolyte or to add distilled water. However, the battery coupler needs to be checked and, if necessary, securely fastened.

EWA10760

### **! WARNING**

- **Electrolyte is poisonous and dangerous since it contains sulfuric acid, which causes severe burns. Avoid any contact with skin, eyes or clothing and al-**

# PERIODIC MAINTENANCE AND ADJUSTMENT

ways shield your eyes when working near batteries. In case of contact, administer the following FIRST AID.

- **EXTERNAL:** Flush with plenty of water.
- **INTERNAL:** Drink large quantities of water or milk and immediately call a physician.
- **EYES:** Flush with water for 15 minutes and seek prompt medical attention.
- Batteries produce explosive hydrogen gas. Therefore, keep sparks, flames, cigarettes, etc., away from the battery and provide sufficient ventilation when charging it in an enclosed space.
- **KEEP THIS AND ALL BATTERIES OUT OF THE REACH OF CHILDREN.**

## To charge the battery

Have a Yamaha dealer charge the battery as soon as possible if it seems to have discharged. Keep in mind that the

battery tends to discharge more quickly if the vehicle is equipped with optional electrical accessories.

ECA16521

## **NOTICE**

To charge a VRLA (Valve Regulated Lead Acid) battery, a special (constant-voltage) battery charger is required. Using a conventional battery charger will damage the battery.

## To store the battery

1. If the model will not be used for more than one month, remove the battery, fully charge it, and then place it in a cool, dry place. **NOTICE:** When removing the battery, be sure the key is turned to “OFF” before disconnecting the coupler. [ECA16322]
2. If the battery will be stored for more than two months, check it at least once a month and fully charge it if necessary.
3. Fully charge the battery before installation. **NOTICE:** When installing the battery, be sure the key is turned to “OFF” before connecting the coupler. [ECA16930]

ECA16530

## **NOTICE**

Always keep the battery charged. Storing a discharged battery can cause permanent battery damage.

# PERIODIC MAINTENANCE AND ADJUSTMENT

## Replacing the fuses

EAU23526

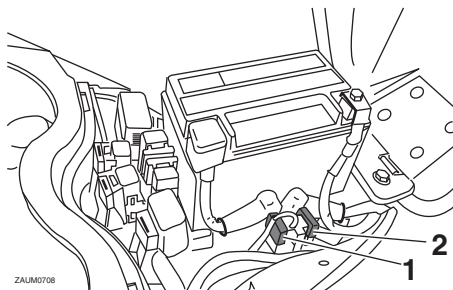

1. Main fuse
2. Spare fuse

The main fuse and the fuse box, which contains the fuses for the individual circuits, are located behind panel A. (See page 6-8.)

If a fuse is blown, replace it as follows.

1. Turn the key to "OFF" and turn off the electrical circuit in question.
2. Remove the blown fuse, and then install a new fuse of the specified amperage. **WARNING! Do not use a fuse of a higher amperage rating than recommended to avoid causing extensive damage to the electrical system and possibly a fire.** [EWA15131]

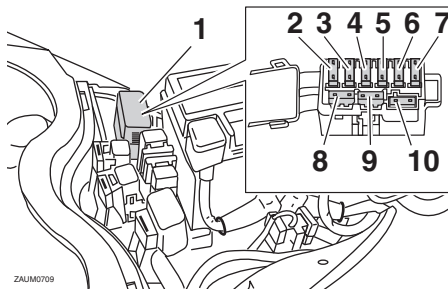

ZAJUM0709

1. Fuse box
2. Radiator fan fuse
3. ECU fuse
4. Backup fuse
5. Signaling system fuse
6. Headlight fuse
7. Ignition fuse
8. Spare fuse
9. Spare fuse
10. Spare fuse

### Specified fuses:

- Main fuse:  
30.0 A
- ECU fuse:  
5.0 A
- Signaling system fuse:  
15.0 A
- Ignition fuse:  
10.0 A
- Headlight fuse:  
15.0 A
- Backup fuse:  
5.0 A
- Radiator fan fuse:  
10.0 A

3. Turn the key to "ON" and turn on the electrical circuit in question to check if the device operates.
4. If the fuse immediately blows again, have a Yamaha dealer check the electrical system.

# PERIODIC MAINTENANCE AND ADJUSTMENT

## Replacing a headlight bulb

EAUM2182

This model is equipped with halogen bulb headlights. If a headlight bulb burns out, replace it as follows.

ECA10650

### NOTICE

Take care not to damage the following parts:

- **Headlight bulb**

Do not touch the glass part of the headlight bulb to keep it free from oil, otherwise the transparency of the glass, the luminosity of the bulb, and the bulb life will be adversely affected. Thoroughly clean off any dirt and fingerprints on the headlight bulb using a cloth moistened with alcohol or thinner.

- **Headlight lens**

Do not affix any type of tinted film or stickers to the headlight lens.

Do not use a headlight bulb of a wattage higher than specified.

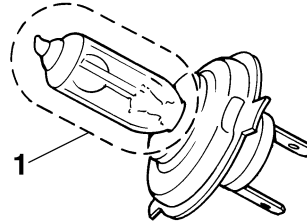

1. Do not touch the glass part of the bulb.

## To replace a high beam headlight bulb

1. Remove cowling A. (See page 6-8.)
2. Remove the headlight bulb cover.

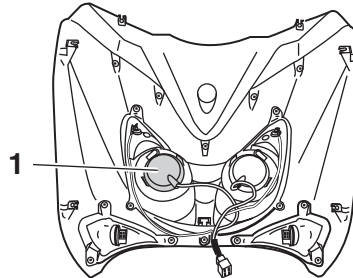

ZALUM0674

1. Headlight bulb cover

3. Unhook the headlight bulb holder by turning it counterclockwise, and then remove the burnt out bulb.

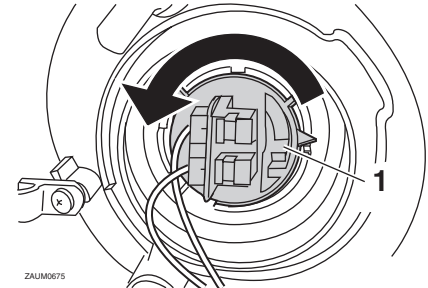

ZALUM0675

1. Headlight bulb holder
4. Place a new headlight bulb into position, and then secure it with the bulb holder by turning it clockwise.
5. Install the headlight bulb cover.
6. Install the cowling.
7. Have a Yamaha dealer adjust the headlight beam if necessary.

## To replace a low beam headlight bulb

1. Remove cowling A. (See page 6-8.)
2. Remove the headlight bulb cover.

# PERIODIC MAINTENANCE AND ADJUSTMENT

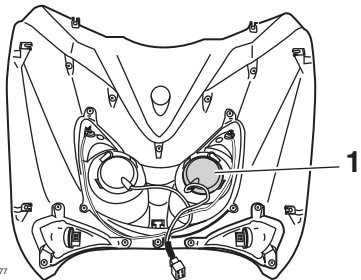

ZALUM0677

1. Headlight bulb cover

3. Disconnect the headlight coupler.
4. Unhook the headlight bulb holder, and then remove the burnt out bulb.

6

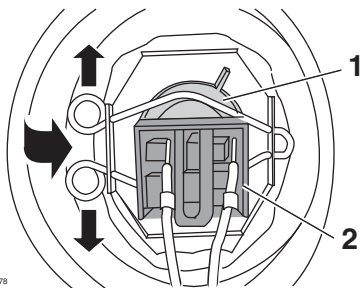

ZALUM0678

1. Headlight bulb  
2. Headlight coupler

5. Place a new headlight bulb into position, and then secure it with the bulb holder.
6. Connect the headlight coupler.
7. Install the headlight bulb cover.
8. Install the cowling.
9. Have a Yamaha dealer adjust the headlight beam if necessary.

## Replacing a front turn signal light bulb

EAUT1263

ECA10670

### NOTICE

**It is advisable to have a Yamaha dealer perform this job.**

1. Place the scooter on the center-stand.
2. Remove cowling A. (See page 6-8.)
3. Remove the turn signal light bulb socket (together with the bulb) by turning it counterclockwise.

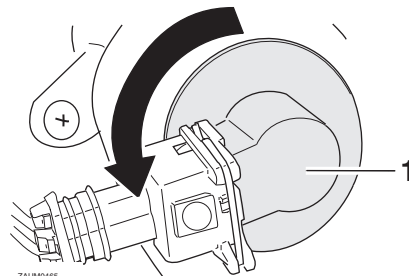

ZALUM0466

1. Turn signal light bulb socket

4. Remove the burnt-out bulb by pushing it in and turning it counterclockwise.

# PERIODIC MAINTENANCE AND ADJUSTMENT

5. Insert a new bulb into the socket, push it in, and then turn it clockwise until it stops.
6. Install the socket (together with the bulb) by turning it clockwise.
7. Install the cowling.

## Replacing a tail/brake light bulb or a rear turn signal light bulb

EAUM2191

1. Place the vehicle on the center-stand.
2. Remove panel B. (See page 6-8.)
3. Remove the tail/brake light unit by removing the screws.

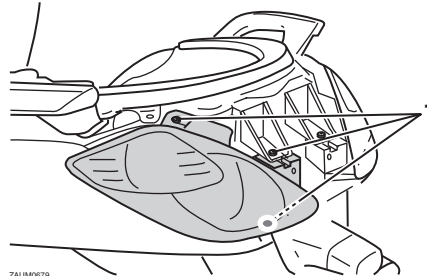

ZAUM0679

1. Screw

4. Remove the socket (together with the bulb) by turning it counter-clockwise.

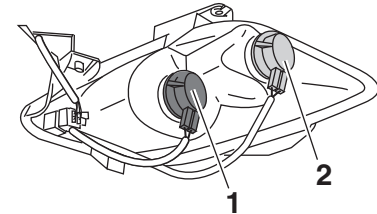

ZAUM0680

1. Tail/brake light bulb socket
2. Turn signal light bulb socket

5. Remove the burnt out bulb by pushing it in and turning it counter-clockwise.
6. Insert a new bulb into the socket, push it in, and then turn it clockwise until it stops.
7. Install the socket (together with the bulb) by turning it clockwise.
8. Install the screws and the tail/brake light unit.
9. Install the panel.

# PERIODIC MAINTENANCE AND ADJUSTMENT

EAM2202

## Replacing the license plate light bulb

1. Remove the socket (together with the bulb) by pulling it out.

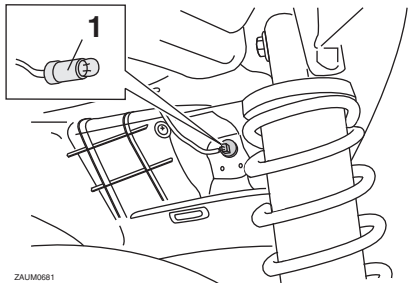

ZALUM0681

1. License plate light bulb socket

2. Remove the burnt-out bulb by pulling it out.
3. Insert a new bulb into the socket.
4. Install the socket (together with the bulb) by pushing it in.

EAM2212

## Replacing an auxiliary light bulb

This model is equipped with two auxiliary lights. If an auxiliary light bulb burns out, replace it as follows.

1. Remove cowling A. (See page 6-8.)
2. Remove the socket (together with the bulb) by pulling it out.

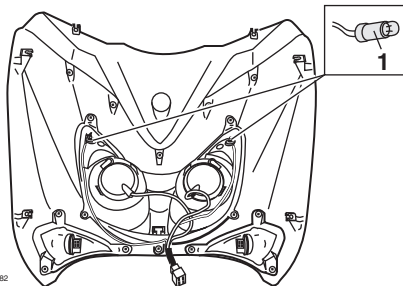

ZALUM0682

1. Auxiliary light bulb socket

3. Remove the burnt out bulb by pulling it out.
4. Insert a new bulb into the socket.
5. Install the socket (together with the bulb) by pushing it in.
6. Install the cowling.

EAU25881

## Troubleshooting

Although Yamaha scooters receive a thorough inspection before shipment from the factory, trouble may occur during operation. Any problem in the fuel, compression, or ignition systems, for example, can cause poor starting and loss of power.

The following troubleshooting charts represent quick and easy procedures for checking these vital systems yourself. However, should your scooter require any repair, take it to a Yamaha dealer, whose skilled technicians have the necessary tools, experience, and know-how to service the scooter properly.

Use only genuine Yamaha replacement parts. Imitation parts may look like Yamaha parts, but they are often inferior, have a shorter service life and can lead to expensive repair bills.

EWA15141

### **WARNING**

**When checking the fuel system, do not smoke, and make sure there are no open flames or sparks in the area, including pilot lights from water**



## **PERIODIC MAINTENANCE AND ADJUSTMENT**

---

---

heaters or furnaces. Gasoline or gasoline vapors can ignite or explode, causing severe injury or property damage.

---

# PERIODIC MAINTENANCE AND ADJUSTMENT

EAU42134

## Troubleshooting charts

### Starting problems or poor engine performance

#### 1. Fuel

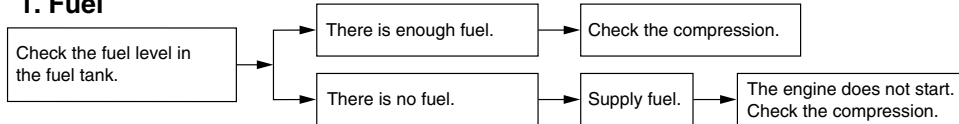

#### 2. Compression

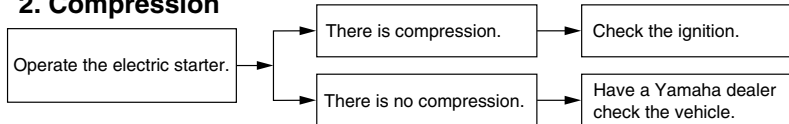

#### 3. Ignition

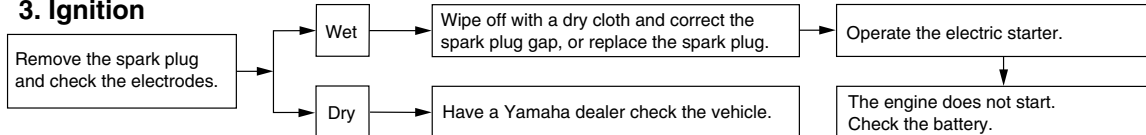

#### 4. Battery

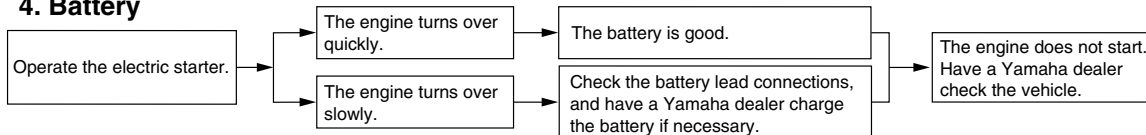

# PERIODIC MAINTENANCE AND ADJUSTMENT

## Engine overheating

EWA10400

### WARNING

- Do not remove the radiator cap when the engine and radiator are hot. Scalding hot fluid and steam may be blown out under pressure, which could cause serious injury. Be sure to wait until the engine has cooled.
- After removing the radiator cap retaining bolt, place a thick rag, like a towel, over the radiator cap, and then slowly rotate the cap counterclockwise to the detent to allow any residual pressure to escape. When the hissing sound has stopped, press down on the cap while turning it counterclockwise, and then remove the cap.

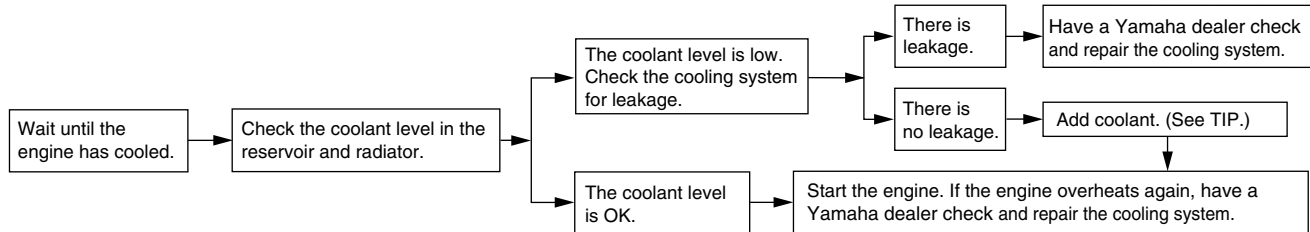

### TIP

If coolant is not available, tap water can be temporarily used instead, provided that it is changed to the recommended coolant as soon as possible.

# SCOOTER CARE AND STORAGE

## Care

While the open design of a scooter reveals the attractiveness of the technology, it also makes it more vulnerable. Rust and corrosion can develop even if high-quality components are used. A rusty exhaust pipe may go unnoticed on a car, however, it detracts from the overall appearance of a scooter. Frequent and proper care does not only comply with the terms of the warranty, but it will also keep your scooter looking good, extend its life and optimize its performance.

EAU26094

## Before cleaning

1. Cover the muffler outlet with a plastic bag after the engine has cooled down.
2. Make sure that all caps and covers as well as all electrical couplers and connectors, including the spark plug cap, are tightly installed.
3. Remove extremely stubborn dirt, like oil burnt onto the crankcase, with a degreasing agent and a brush, but never apply such prod-

ucts onto seals, gaskets and wheel axles. Always rinse the dirt and degreaser off with water.

## Cleaning

### NOTICE

ECA10783

- **Avoid using strong acidic wheel cleaners, especially on spoked wheels. If such products are used on hard-to-remove dirt, do not leave the cleaner on the affected area any longer than instructed. Also, thoroughly rinse the area off with water, immediately dry it, and then apply a corrosion protection spray.**
- **Improper cleaning can damage plastic parts (such as cowlings, panels, windshields, headlight lenses, meter lenses, etc.) and the mufflers. Use only a soft, clean cloth or sponge with water to clean plastic. However, if the plastic parts cannot be thoroughly cleaned with water, diluted mild detergent with water may be used. Be sure to rinse**

**off any detergent residue using plenty of water, as it is harmful to plastic parts.**

- **Do not use any harsh chemical products on plastic parts. Be sure to avoid using cloths or sponges which have been in contact with strong or abrasive cleaning products, solvent or thinner, fuel (gasoline), rust removers or inhibitors, brake fluid, antifreeze or electrolyte.**
- **Do not use high-pressure washers or steam-jet cleaners since they cause water seepage and deterioration in the following areas: seals (of wheel and swing-arm bearings, fork and brakes), electric components (couplers, connectors, instruments, switches and lights), breather hoses and vents.**
- **For scooters equipped with a windshield: Do not use strong cleaners or hard sponges as they will cause dulling or scratching. Some cleaning compounds for plastic may leave scratches on the windshield.**

# SCOOTER CARE AND STORAGE

**Test the product on a small hidden part of the windshield to make sure that it does not leave any marks. If the windshield is scratched, use a quality plastic polishing compound after washing.**

## After normal use

Remove dirt with warm water, a mild detergent, and a soft, clean sponge, and then rinse thoroughly with clean water. Use a toothbrush or bottlebrush for hard-to-reach areas. Stubborn dirt and insects will come off more easily if the area is covered with a wet cloth for a few minutes before cleaning.

## After riding in the rain, near the sea or on salt-sprayed roads

Since sea salt or salt sprayed on the roads during winter are extremely corrosive in combination with water, carry out the following steps after each ride in the rain, near the sea or on salt-sprayed roads.

## **TIP**

Salt sprayed on roads in the winter may remain well into spring.

1. Clean the scooter with cold water and a mild detergent after the engine has cooled down. **NOTICE: Do not use warm water since it increases the corrosive action of the salt.**<sup>[ECA10791]</sup>
2. Apply a corrosion protection spray on all metal, including chrome- and nickel-plated, surfaces to prevent corrosion.

## **After cleaning**

1. Dry the scooter with a chamois or an absorbing cloth.
2. Use a chrome polish to shine chrome, aluminum and stainless-steel parts, including the exhaust system. (Even the thermally induced discoloring of stainless-steel exhaust systems can be removed through polishing.)

3. To prevent corrosion, it is recommended to apply a corrosion protection spray on all metal, including chrome- and nickel-plated, surfaces.
4. Use spray oil as a universal cleaner to remove any remaining dirt.
5. Touch up minor paint damage caused by stones, etc.
6. Wax all painted surfaces.
7. Let the scooter dry completely before storing or covering it.

EWA10942

## **WARNING**

**Contaminants on the brakes or tires can cause loss of control.**

- **Make sure that there is no oil or wax on the brakes or tires. If necessary, clean the brake discs and brake linings with a regular brake disc cleaner or acetone, and wash the tires with warm water and a mild detergent.**
- **Before operating the scooter test its braking performance and cornering behavior.**

# SCOOTER CARE AND STORAGE

---

ECA10800

## NOTICE

---

- Apply spray oil and wax sparingly and make sure to wipe off any excess.
  - Never apply oil or wax to any rubber and plastic parts, but treat them with a suitable care product.
  - Avoid using abrasive polishing compounds as they will wear away the paint.
- 

## TIP

---

- Consult a Yamaha dealer for advice on what products to use.
  - Washing, rainy weather or humid climates can cause the headlight lens to fog. Turning the headlight on for a short period of time will help remove the moisture from the lens.
- 

## Storage

### Short-term

Always store your scooter in a cool, dry place and, if necessary, protect it against dust with a porous cover. Be sure the engine and the exhaust system are cool before covering the scooter.

## NOTICE

---

- Storing the scooter in a poorly ventilated room or covering it with a tarp, while it is still wet, will allow water and humidity to seep in and cause rust.
  - To prevent corrosion, avoid damp cellars, stables (because of the presence of ammonia) and areas where strong chemicals are stored.
- 

### Long-term

Before storing your scooter for several months:

1. Follow all the instructions in the “Care” section of this chapter.

EAU36563

2. Fill up the fuel tank and add fuel stabilizer (if available) to prevent the fuel tank from rusting and the fuel from deteriorating.
3. Perform the following steps to protect the cylinder, piston rings, etc. from corrosion.
  - a. Remove the spark plug cap and spark plug.
  - b. Pour a teaspoonful of engine oil into the spark plug bore.
  - c. Install the spark plug cap onto the spark plug, and then place the spark plug on the cylinder head so that the electrodes are grounded. (This will limit sparking during the next step.)
  - d. Turn the engine over several times with the starter. (This will coat the cylinder wall with oil.)
  - e. Remove the spark plug cap from the spark plug, and then install the spark plug and the spark plug cap. **WARNING! To prevent damage or injury from sparking, make sure to ground the spark plug electrodes while turning the engine over.** [EWA10951]

ECA10820

# SCOOTER CARE AND STORAGE

---

---

4. Lubricate all control cables and the pivoting points of all levers and pedals as well as of the side-stand/centerstand.
5. Check and, if necessary, correct the tire air pressure, and then lift the scooter so that both of its wheels are off the ground. Alternatively, turn the wheels a little every month in order to prevent the tires from becoming degraded in one spot.
6. Cover the muffler outlet with a plastic bag to prevent moisture from entering it.
7. Remove the battery and fully charge it. Store it in a cool, dry place and charge it once a month. Do not store the battery in an excessively cold or warm place [less than 0 °C (30 °F) or more than 30 °C (90 °F)]. For more information on storing the battery, see page 6-25.

## **TIP** \_\_\_\_\_

Make any necessary repairs before storing the scooter.

---

# SPECIFICATIONS

## Dimensions:

Overall length:  
2175 mm (85.6 in)  
Overall width:  
785 mm (30.9 in)  
Overall height:  
1475 mm (58.1 in)  
Seat height:  
790 mm (31.1 in)  
Wheelbase:  
1455 mm (57.3 in)  
Ground clearance:  
165 mm (6.5 in)  
Minimum turning radius:  
2300 mm (90.6 in)

## Weight:

Curb weight:  
167 kg (368 lb)

## Engine:

Engine type:  
Liquid cooled 4-stroke, SOHC  
Cylinder arrangement:  
Single cylinder  
Displacement:  
124 cm<sup>3</sup>  
Bore × stroke:  
52.0 × 58.6 mm (2.05 × 2.31 in)  
Compression ratio:  
11.20 : 1  
Starting system:  
Electric starter  
Lubrication system:  
Wet sump

## Engine oil:

Type:  
SAE 10W-30, 10W-40, 15W-40, 20W-40 or  
20W-50

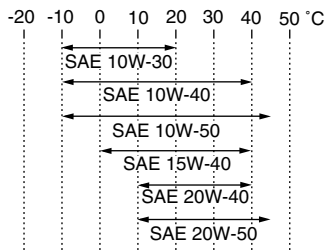

Recommended engine oil grade:  
API service SG type or higher, JASO  
standard MA

Engine oil quantity:  
Without oil filter element replacement:  
1.40 L (1.48 US qt, 1.23 Imp.qt)  
With oil filter element replacement:  
1.50 L (1.59 US qt, 1.32 Imp.qt)

## Final transmission oil:

Type:  
SAE 10W-30 type SE motor oil  
Quantity:  
0.21 L (0.22 US qt, 0.18 Imp.qt)

## Cooling system:

Coolant reservoir capacity (up to the  
maximum level mark):  
0.20 L (0.21 US qt, 0.18 Imp.qt)  
Radiator capacity (including all routes):  
1.02 L (1.08 US qt, 0.90 Imp.qt)

## Air filter:

Air filter element:  
Oil-coated paper element

## Fuel:

Recommended fuel:  
Premium unleaded gasoline only  
Fuel tank capacity:  
10.5 L (2.77 US gal, 2.31 Imp.gal)  
Fuel reserve amount:  
2.7 L (0.72 US gal, 0.60 Imp.gal)

## Fuel injection:

Throttle body:  
ID mark:  
1B91 00

## Spark plug(s):

Manufacturer/model:  
NGK/CPR9EA-9  
Spark plug gap:  
0.8–0.9 mm (0.031–0.035 in)

## Clutch:

Clutch type:  
Dry, centrifugal automatic

## Transmission:

Primary reduction ratio:  
1.000  
Final drive:  
Gear  
Secondary reduction ratio:  
41/14 × 44/12 (10.73)  
Transmission type:  
V-belt automatic

## Chassis:

Frame type:  
Underbone



Caster angle:

26.00 °

Trail:

96 mm (3.8 in)

## Front tire:

Type:

Tubeless

Size:

120/70-16 M/C 57P

Manufacturer/model:

PIRELLI/SPORT DEMON FRONT

## Rear tire:

Type:

Tubeless

Size:

140/70-15 M/C 69P

Manufacturer/model:

PIRELLI/SPORT DEMON

## Loading:

Maximum load:

185 kg (408 lb)

(Total weight of rider, passenger, cargo and accessories)

## Tire air pressure (measured on cold tires):

Loading condition:

0–90 kg (0–198 lb)

Front:

170 kPa (1.70 kgf/cm<sup>2</sup>, 25 psi)

Rear:

190 kPa (1.90 kgf/cm<sup>2</sup>, 28 psi)

Loading condition:

90–185 kg (198–408 lb)

Front:

180 kPa (1.80 kgf/cm<sup>2</sup>, 26 psi)

Rear:

200 kPa (2.00 kgf/cm<sup>2</sup>, 29 psi)

## Front wheel:

Wheel type:

Cast wheel

Rim size:

16 M/C x MT3.00

## Rear wheel:

Wheel type:

Cast wheel

Rim size:

15 M/C x MT4.00

## Front brake:

Type:

Single disc brake

Operation:

Right hand operation

Specified brake fluid:

DOT 4

## Rear brake:

Type:

Single disc brake

Operation:

Left hand operation

Specified brake fluid:

DOT 4

## Front suspension:

Type:

Telescopic fork

Spring/shock absorber type:

Coil spring/oil damper

Wheel travel:

100.0 mm (3.94 in)

## Rear suspension:

Type:

Unit swing

Spring/shock absorber type:

Coil spring/oil damper

Wheel travel:

105.0 mm (4.13 in)

## Electrical system:

Ignition system:

TCI

Charging system:

AC magneto

## Battery:

Model:

GTX9-BS

Voltage, capacity:

12 V, 8.0 Ah

## Headlight:

Bulb type:

Halogen bulb

## Bulb voltage, wattage × quantity:

Low beam headlight:

12 V, 55.0 W × 1

High beam headlight:

12 V, 55.0 W × 1

Tail/brake light:

12 V, 5.0 W/21.0 W × 2

Front turn signal light:

12 V, 10.0 W × 2

Rear turn signal light:

12 V, 10.0 W × 2

# SPECIFICATIONS

---

Auxiliary light:

12 V, 5.0 W × 2

License plate light:

12 V, 5.0 W × 1

Meter lighting:

LED

High beam indicator light:

LED

Turn signal indicator light:

LED x 2

Fuel level warning light:

LED

Engine trouble warning light:

LED

Immobilizer system indicator light:

LED

## Fuses:

Main fuse:

30.0 A

Headlight fuse:

15.0 A

Signaling system fuse:

15.0 A

Ignition fuse:

10.0 A

Radiator fan fuse:

10.0 A

ECU fuse:

5.0 A

Backup fuse:

5.0 A

## Identification numbers

EAU48612

Record the vehicle identification number and model label information in the spaces provided below for assistance when ordering spare parts from a Yamaha dealer or for reference in case the vehicle is stolen.

VEHICLE IDENTIFICATION  
NUMBER:

MODEL LABEL INFORMATION:

## Vehicle identification number

EAU26410

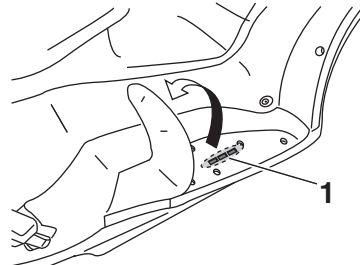

ZAJM0663

1. Vehicle identification number

The vehicle identification number is stamped into the frame.

**TIP** \_\_\_\_\_  
The vehicle identification number is used to identify your vehicle and may be used to register it with the licensing authority in your area.

## Model label

EAU26490

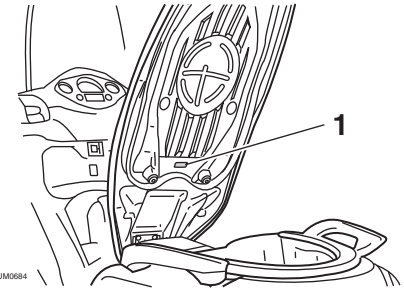

ZAJM0684

1. Model label

The model label is affixed to the bottom of the seat. (See page 3-12.) Record the information on this label in the space provided. This information will be needed when ordering spare parts from a Yamaha dealer.

# INDEX

---

## A

- Acceleration and deceleration..... 5-3
- Air filter and V-belt case air filter elements ..... 6-15
- Auxiliary light bulb, replacing ..... 6-31

## B

- Battery..... 6-25
- Brake fluid, changing ..... 6-22
- Brake fluid level, checking ..... 6-21
- Brake lever, front..... 3-9
- Brake lever, rear ..... 3-9
- Brake levers, lubricating..... 6-23
- Braking..... 5-3

## C

- Cables, checking and lubricating ..... 6-22
- Care ..... 7-1
- Carrier ..... 3-16
- Catalytic converters ..... 3-12
- Centerstand and sidestand, checking and lubricating ..... 6-23
- Coolant..... 6-14
- Coolant temperature gauge ..... 3-5
- Cowlings and panels, removing and installing..... 6-8

## D

- Dimmer switch ..... 3-9
- Display, multi-function..... 3-5

## E

- Engine break-in..... 5-4
- Engine oil ..... 6-10
- Engine trouble warning light..... 3-3

## F

- Final transmission oil ..... 6-13
- Front and rear brake lever free play..... 6-19

- Front and rear brake pads, checking.... 6-20
- Front fork, checking..... 6-24
- Fuel..... 3-10
- Fuel consumption, tips for reducing..... 5-4
- Fuel gauge..... 3-5
- Fuel tank cap ..... 3-10
- Fuses, replacing ..... 6-27

## H

- Handlebar switches ..... 3-8
- Headlight bulb, replacing..... 6-28
- High beam indicator light..... 3-3
- Horn switch..... 3-9

## I

- Identification numbers ..... 9-1
- Ignition circuit cut-off system ..... 3-17
- Immobilizer system ..... 3-1
- Immobilizer system indicator light..... 3-3
- Indicator lights and warning light ..... 3-3

## L

- License plate light bulb, replacing ..... 6-31
- Luggage hook..... 3-16

## M

- Main switch/steering lock..... 3-2
- Maintenance and lubrication, periodic .... 6-4
- Maintenance, emission control system... 6-3
- Model label ..... 9-1

## P

- Parking ..... 5-5
- Part locations..... 2-1

## S

- Safe-riding points..... 1-5
- Safety information..... 1-1
- Seat ..... 3-12

- Shock absorber assemblies, adjusting ..... 3-15
- Sidestand ..... 3-16
- Spark plug, checking..... 6-9
- Specifications ..... 8-1
- Speedometer..... 3-4
- Starting off..... 5-2
- Starting the engine ..... 5-1
- Start switch..... 3-9
- Steering, checking..... 6-25
- Storage..... 7-3
- Storage compartments..... 3-13

## T

- Tail/brake light bulb or rear turn signal light bulb, replacing..... 6-30
- Throttle grip and cable, checking and lubricating ..... 6-23
- Throttle grip free play, checking ..... 6-16
- Tires ..... 6-17
- Tool kit..... 6-2
- Troubleshooting ..... 6-31
- Troubleshooting charts..... 6-33
- Turn signal indicator light ..... 3-3
- Turn signal light bulb (front), replacing ..... 6-29
- Turn signal switch ..... 3-9

## V

- Valve clearance..... 6-17
- Vehicle identification number ..... 9-1

## W

- Wheel bearings, checking ..... 6-25
- Wheels ..... 6-19
- Windshield..... 3-14





**MBK Industrie**

**Z.I. de Rouvroy 02100 Saint Quentin**

Société Anonyme au capital de 45 000 000 €

R.C St-Quentin B 329 035 422

PRINTED IN FRANCE  
2012.07 (E)