



**OWNER'S MANUAL**

**max**

**125i**

**YP125R**

**1B9-F8199-E1**

## DECLARATION of CONFORMITY

We

Company: MORIC CO., LTD.

Address: 1450-6 Mori Mori-Machi Shuchi-gun Shizuoka 437-0292 Japan

Hereby declare that the product:

Kind of equipment: IMMOBILIZER

Type-designation: 5SL-00

is in compliance with following norm(s) or documents:

R&TTE Directive(1999/5/EC)

EN300 330-2 v1.1.1(2001-6), EN60950(2000)

Two or Three-Wheel Motor Vehicles Directive(97/24/EC: Chapter 8, EMC)

Place of issue: Shizuoka, Japan

Date of issue: 1 Aug. 2002

### Revolution record

No.	Contents	Date
1	To change contact person and integrate type-designation.	9 Jun. 2005

General manager of quality assurance div.

*9 Jun 2005*  
*T. Seguchi*  
\_\_\_\_\_  
representative name and signature

MORIC CO., LTD.

1450-6 Mori-machi Shuchi-gun Shizuoka 437-0292 JAPAN Telephone +81-538-85-0757 Facsimile +81-538-85-0456

URL: <http://www.moric-jp.com>

Welcome to the Yamaha world of motorcycling!

As the owner of the YP125R, you are benefiting from Yamaha's vast experience and newest technology regarding the design and manufacture of high-quality products, which have earned Yamaha a reputation for dependability.

Please take the time to read this manual thoroughly, so as to enjoy all advantages of your YP125R. The owner's manual does not only instruct you in how to operate, inspect and maintain your scooter, but also in how to safeguard yourself and others from trouble and injury.

In addition, the many tips given in this manual will help keep your scooter in the best possible condition. If you have any further questions, do not hesitate to contact your Yamaha dealer.



The Yamaha team wishes you many safe and pleasant rides. So, remember to put safety first!

# IMPORTANT MANUAL INFORMATION

---

EAU34110

Particularly important information is distinguished in this manual by the following notations:

	<b>The Safety Alert Symbol means ATTENTION! BECOME ALERT! YOUR SAFETY IS INVOLVED!</b>
 <b>WARNING</b>	Failure to follow <b>WARNING</b> instructions <u>could result in severe injury or death</u> to the scooter operator, a bystander, or a person inspecting or repairing the scooter.
<b>CAUTION:</b>	A <b>CAUTION</b> indicates special precautions that must be taken to avoid damage to the scooter.
<b>NOTE:</b>	A <b>NOTE</b> provides key information to make procedures easier or clearer.

## NOTE:

- This manual should be considered a permanent part of this scooter and should remain with it even if the scooter is subsequently sold.
- Yamaha continually seeks advancements in product design and quality. Therefore, while this manual contains the most current product information available at the time of printing, there may be minor discrepancies between your scooter and this manual. If you have any questions concerning this manual, please consult your Yamaha dealer.

EWA12410

## **WARNING**

---

**PLEASE READ THIS MANUAL CAREFULLY AND COMPLETELY BEFORE OPERATING THIS SCOOTER.**

---

# IMPORTANT MANUAL INFORMATION

---

EAUS1171

**YP125R  
OWNER'S MANUAL**  
©2006 by YAMAHA MOTOR ESPAÑA S.A.  
1st edition, October 2006  
All rights reserved.  
Any reprinting or unauthorized use  
without the written permission of  
YAMAHA MOTOR ESPAÑA S.A.  
is expressly prohibited.  
Printed in Spain.

# TABLE OF CONTENTS

---

<b>SAFETY INFORMATION</b> .....	1-1	<b>PRE-OPERATION CHECKS</b> .....	4-1	Front and rear brake lever free	
<b>DESCRIPTION</b> .....	2-1	Pre-operation check list.....	4-2	play .....	6-17
Left view .....	2-1	<b>OPERATION AND IMPORTANT</b>		Checking the front and rear brake	
Right view .....	2-2	<b>RIDING POINTS</b> .....	5-1	pads.....	6-17
Controls and instruments .....	2-3	Starting a cold engine .....	5-1	Checking the brake fluid level .....	6-18
<b>INSTRUMENT AND CONTROL</b>		Starting off .....	5-2	Changing the brake fluid .....	6-19
<b>FUNCTIONS</b> .....	3-1	Acceleration and deceleration.....	5-2	Checking and lubricating the	
Immobilizer system.....	3-1	Braking.....	5-2	throttle grip and cable.....	6-19
Main switch/steering lock.....	3-2	Tips for reducing fuel consumption..	5-3	Lubricating the front and rear	
Indicators, indicator lights and		Engine break-in.....	5-3	brake levers .....	6-20
warning light.....	3-3	Parking.....	5-4	Checking and lubricating the	
Speedometer .....	3-4	<b>PERIODIC MAINTENANCE AND</b>		centerstand and sidestand .....	6-20
Fuel gauge .....	3-4	<b>MINOR REPAIR</b> .....	6-1	Checking the front fork.....	6-20
Coolant temperature gauge.....	3-4	Owner's tool kit.....	6-1	Checking the steering.....	6-21
Multi-function display .....	3-5	Periodic maintenance and		Checking the wheel bearings .....	6-22
Anti-theft alarm (optional).....	3-7	lubrication chart .....	6-3	Battery .....	6-22
Handlebar switches .....	3-8	Removing and installing cowlings		Replacing the fuses .....	6-23
Front brake lever.....	3-9	and panels.....	6-6	Replacing a headlight bulb.....	6-24
Rear brake lever.....	3-9	Checking the spark plug .....	6-7	Replacing a front turn signal	
Fuel tank cap .....	3-10	Engine oil .....	6-8	light bulb.....	6-25
Fuel .....	3-10	Final transmission oil .....	6-10	Replacing the tail/brake light bulb	
Catalytic converter.....	3-11	Coolant .....	6-11	or a rear turn signal light bulb.....	6-25
Seat.....	3-11	Air filter and V-belt case air filter		Replacing the license plate light	
Front storage compartment.....	3-12	elements .....	6-12	bulb .....	6-26
Storage compartment.....	3-12	Adjusting the throttle cable		Replacing the auxiliary light bulb ...	6-27
Adjusting the shock absorber		free play.....	6-14	Troubleshooting .....	6-27
assemblies.....	3-13	Valve clearance.....	6-15	Troubleshooting charts .....	6-28
Sidestand.....	3-13	Tires .....	6-15	<b>SCOOTER CARE AND STORAGE</b> .....	7-1
		Cast wheels .....	6-17	Care .....	7-1
				Storage .....	7-3

# TABLE OF CONTENTS

---

---

**SPECIFICATIONS** .....8-1

**CONSUMER INFORMATION** .....9-1

    Identification numbers .....9-1

# SAFETY INFORMATION

EAU10260

SCOOTERS ARE SINGLE TRACK VEHICLES. THEIR SAFE USE AND OPERATION ARE DEPENDENT UPON THE USE OF PROPER RIDING TECHNIQUES AS WELL AS THE EXPERTISE OF THE OPERATOR. EVERY OPERATOR SHOULD KNOW THE FOLLOWING REQUIREMENTS BEFORE RIDING THIS SCOOTER.

HE OR SHE SHOULD:

- OBTAIN THOROUGH INSTRUCTIONS FROM A COMPETENT SOURCE ON ALL ASPECTS OF SCOOTER OPERATION.
- OBSERVE THE WARNINGS AND MAINTENANCE REQUIREMENTS IN THE OWNER'S MANUAL.
- OBTAIN QUALIFIED TRAINING IN SAFE AND PROPER RIDING TECHNIQUES.
- OBTAIN PROFESSIONAL TECHNICAL SERVICE AS INDICATED BY THE OWNER'S MANUAL AND/OR WHEN MADE NECESSARY BY MECHANICAL CONDITIONS.

## Safe riding

- Always make pre-operation checks. Careful checks may help prevent an accident.
- This scooter is designed to carry the operator and passenger.
- The failure of motorists to detect and recognize scooters in traffic is the predominating cause of automobile/scooter accidents. Many accidents have been caused by an automobile driver who did not see the scooter. Making yourself conspicuous appears to be very effective in reducing the chance of this type of accident.
- **Therefore:**
  - Wear a brightly colored jacket.
  - Use extra caution when approaching and passing through intersections, since intersections are the most likely places for scooter accidents to occur.
  - Ride where other motorists can see you. Avoid riding in another motorist's blind spot.
- Many accidents involve inexperienced operators. In fact, many operators who have been invol-

ved in accidents do not even have a current driver's license.

- Make sure that you are qualified and that you only lend your scooter to other qualified operators.
- Know your skills and limits. Staying within your limits may help you to avoid an accident.
- We recommend that you practice riding your scooter where there is no traffic until you have become thoroughly familiar with the scooter and all of its controls.
- Many accidents have been caused by error of the scooter operator. A typical error made by the operator is veering wide on a turn due to EXCESSIVE SPEED or undercornering (insufficient lean angle for the speed).
  - Always obey the speed limit and never travel faster than warranted by road and traffic conditions.
  - Always signal before turning or changing lanes. Make sure that other motorists can see you.



- The posture of the operator and passenger is important for proper control.
- The operator should keep both hands on the handlebar and both feet on the footboard during operation to maintain control of the scooter.
- The passenger should always hold onto the operator, the seat strap or grab bar, if equipped, with both hands and keep both feet on the passenger footrests.
- Never carry a passenger unless he or she can firmly place both feet on the passenger footrests.
- Never ride under the influence of alcohol or other drugs.
- This scooter is designed for on-road use only. It is not suitable for off-road use.

## **Protective apparel**

The majority of fatalities from scooter accidents are the result of head injuries. The use of a safety helmet is the single most critical factor in the prevention or reduction of head injuries.

- Always wear an approved helmet.
- Wear a face shield or goggles. Wind in your unprotected eyes could contribute to an impairment of vision which could delay seeing a hazard.
- The use of a jacket, substantial shoes, trousers, gloves, etc., is effective in preventing or reducing abrasions or lacerations.
- Never wear loose-fitting clothes, otherwise they could catch on the control levers or wheels and cause injury or an accident.
- Never touch the engine or exhaust system during or after operation. They become very hot and can cause burns. Always wear protective clothing that covers your legs, ankles, and feet.
- Passengers should also observe the above precautions.

## **Modifications**

Modifications made to this scooter not approved by Yamaha, or the removal of original equipment, may render the scooter unsafe for use and may cause severe personal injury. Modifications may also make your scooter illegal to use.

## **Loading and accessories**

Adding accessories or cargo to your scooter can adversely affect stability and handling if the weight distribution of the scooter is changed. To avoid the possibility of an accident, use extreme caution when adding cargo or accessories to your scooter. Use extra care when riding a scooter that has added cargo or accessories. Here are some general guidelines to follow if loading cargo or adding accessories to your scooter:

# SAFETY INFORMATION

---

## Loading

The total weight of the operator, passenger, accessories and cargo must not exceed the maximum load limit of 189 Kg - 416.75 lb. When loading within this weight limit, keep the following in mind:

- Cargo and accessory weight should be kept as low and close to the scooter as possible. Make sure to distribute the weight as evenly as possible on both sides of the scooter to minimize imbalance or instability.
- Shifting weights can create a sudden imbalance. Make sure that accessories and cargo are securely attached to the scooter before riding. Check accessory mounts and cargo restraints frequently.
- Never attach any large or heavy items to the handlebar, front fork, or front fender. Such items can create unstable handling or a slow steering response.

## Accessories

Genuine Yamaha accessories have been specifically designed for use on this scooter. Since Yamaha cannot test all other accessories that may be available, you must personally be responsible for the proper selection, installation and use of non-Yamaha accessories. Use extreme caution when selecting and installing any accessories.

Keep the following guidelines in mind, as well as those provided under “Loading” when mounting accessories.

- Never install accessories or carry cargo that would impair the performance of your scooter. Carefully inspect the accessory before using it to make sure that it does not in any way reduce ground clearance or cornering clearance, limit suspension travel, steering travel or control operation, or obscure lights or reflectors.
- Accessories fitted to the handlebar or the front fork area can create instability due to improper weight distribution or

aerodynamic changes. If accessories are added to the handlebar or front fork area, they must be as lightweight as possible and should be kept to a minimum.

- Bulky or large accessories may seriously affect the stability of the scooter due to aerodynamic effects. Wind may attempt to lift the scooter, or the scooter may become unstable in cross winds. These accessories may also cause instability when passing or being passed by large vehicles.
- Certain accessories can displace the operator from his or her normal riding position. This improper position limits the freedom of movement of the operator and may limit control ability, therefore, such accessories are not recommended.
- Use caution when adding electrical accessories. If electrical accessories exceed the capacity of the scooter’s electrical system

an electric failure could result, which could cause a dangerous loss of lights or engine power.

## Gasoline and exhaust gas

- **GASOLINE IS HIGHLY FLAMMABLE:**
  - Always turn the engine off when refueling.
  - Take care not to spill any gasoline on the engine or exhaust system when refueling.
  - Never refuel while smoking or in the vicinity of an open flame.
- Never start the engine or let it run for any length of time in a closed area. The exhaust fumes are poisonous and may cause loss of consciousness and death within a short time. Always operate your scooter in an area that has adequate ventilation.
- Always turn the engine off before leaving the scooter unattended and remove the key from the main switch. When parking the scooter, note the following:
  - The engine and exhaust system may be hot, therefore, park the scooter in a place

where pedestrians or children are not likely to touch these hot areas.

- Do not park the scooter on a slope or soft ground, otherwise it may fall over.
- Do not park the scooter near a flammable source (e.g., a kerosene heater, or near an open flame), otherwise it could catch fire.
- If you should swallow any gasoline, inhale a lot of gasoline vapor, or allow gasoline to get into your eyes, see your doctor immediately. If any gasoline spills on your skin or clothing, immediately wash the affected area with soap and water and change your clothes.

EAU10371

## Further safe-riding points

- Be sure to signal clearly when making turns.
- Braking can be extremely difficult on a wet road. Avoid hard braking, because the scooter could slide. Apply the brakes slowly

when stopping on a wet surface.

- Slow down as you approach a corner or turn. Once you have completed a turn, accelerate slowly.
- Be careful when passing parked cars. A driver might not see you and open a door in your path.
- Railroad crossings, streetcar rails, iron plates on road construction sites, and manhole covers become extremely slippery when wet. Slow down and cross them with caution. Keep the scooter upright, otherwise it could slide out from under you.
- The brake pads could get wet when you wash the scooter. After washing the scooter, check the brakes before riding.
- Always wear a helmet, gloves, trousers (tapered around the cuff and ankle so they do not flap), and a bright colored jacket.
- Do not carry too much luggage on the scooter. An overloaded scooter is unstable.

# DESCRIPTION

EAU10410

## Left view

2

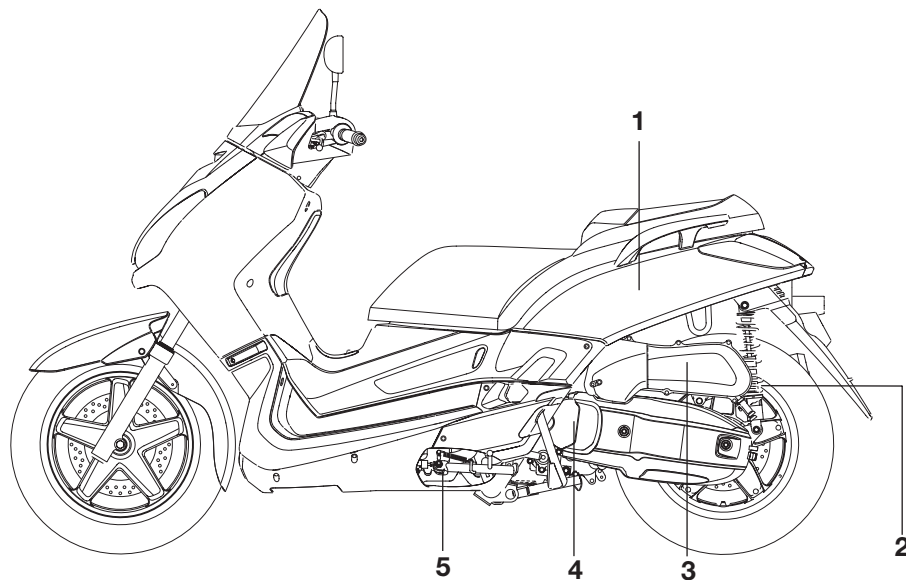

- 1. Storage compartment (page 3-12)
- 2. Spring preload (page 3-13)
- 3. Air filter (page 6-12)

- 4. V-Belt filter (page 6-12)
- 5. Sidestand (page 3-13)

## Right view

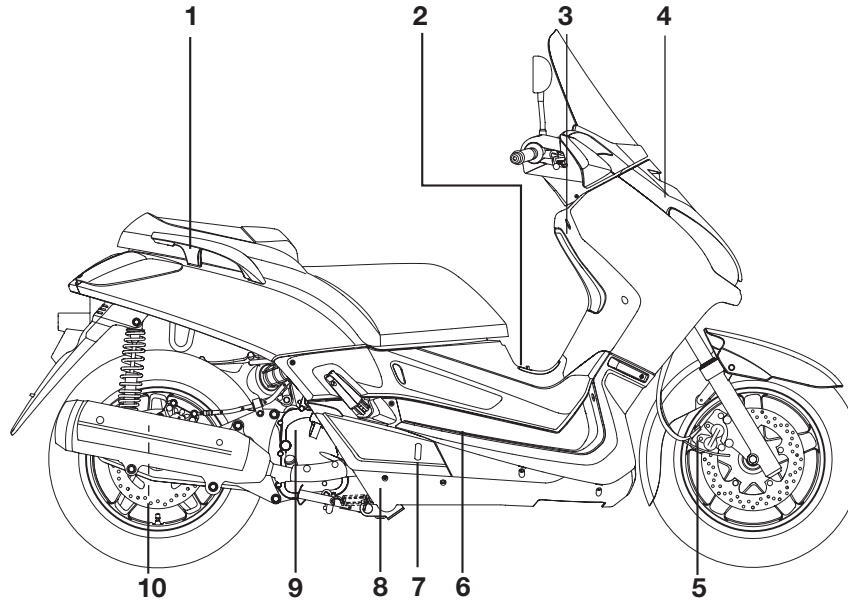

- 1. Grab bar
- 2. Fuel cap (page 3-10)
- 3. Battery (page 6-22)
- 4. Fuses box and main fuse (page 6-23)
- 5. Front brake pads (page 6-17)

- 6. Coolant reservoir cap (page 6-11)
- 7. Coolant level window (page 6-11)
- 8. Centerstand (page 6-20)
- 9. Engine oil filler cap (page 6-8)
- 10. Rear brake pads (page 6-17)

# DESCRIPTION

EAU10430

## Controls and instruments

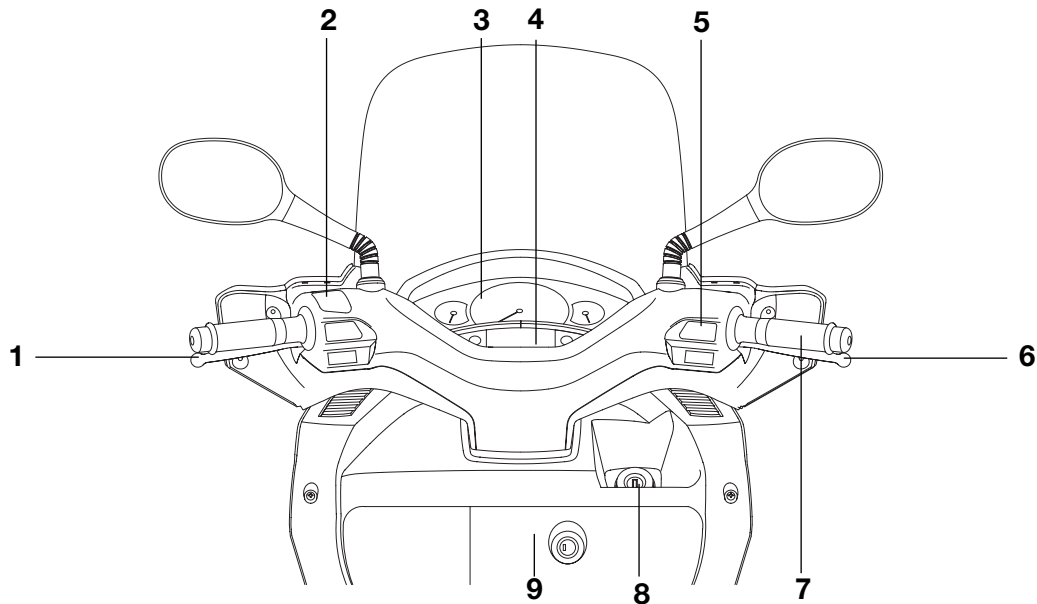

1. Rear brake lever (page 3-9)
2. Left handlebar switches (page 3-8)
3. Speedometer (page 3-4)
4. Multi-function display (page 3-5)
5. Right handlebar switch (page 3-8)

6. Front brake lever (page 3-9)
7. Throttle grip (page 5-2)
8. Main switch/Steering lock (page 3-2)
9. Front storage compartement (page 3-12)

## Immobilizer system

EAU10972

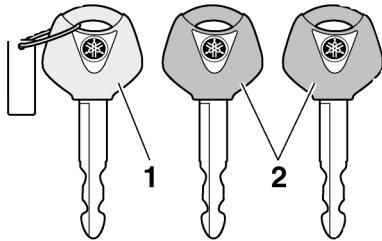

1. Master key
2. Keys

This vehicle is equipped with an immobilizer system to help prevent theft by re-registering codes in the standard keys. This system consists of the following.

- a code re-registering key (with a red bow)
- two standard keys (with a black bow) that can be re-registered with new codes
- a transponder (which is installed in the code re-registering key)
- an immobilizer unit
- an ECU

- an immobilizer system indicator light (See page 3-3.)

The key with the red bow is used to register codes in each standard key. Since re-registering is a difficult process, take the vehicle along with all three keys to a Yamaha dealer to have them re-registered. Do not use the key with the red bow for driving. It should only be used for re-registering the standard keys. Always use a standard key for driving.

ECA11820

### CAUTION:

- **DO NOT LOSE THE CODE RE-REGISTERING KEY! CONTACT YOUR DEALER IMMEDIATELY IF IT IS LOST!** If the code re-registering key is lost, registering new codes in the standard keys is impossible. The standard keys can still be used to start the vehicle, however if code re-registering is required (i.e., if a new standard key is made or all keys are lost) the entire immobilizer system must be replaced. Therefore, it is highly recommended to use either standard key and

keep the code re-registering key in a safe place.

- Do not submerge any key in water.
- Do not expose any key to excessively high temperatures.
- Do not place any key close to magnets (this includes, but not limited to, products such as speakers, etc.).
- Do not place heavy items on any key.
- Do not grind any key or alter its shape.
- Do not disassemble the plastic part of any key.
- Do not put two keys of any immobilizer system on the same key ring.
- Keep the standard keys as well as keys of other immobilizer systems away from this vehicle's code re-registering key.
- Keep other immobilizer system keys away from the main switch as they may cause signal interference.

# INSTRUMENT AND CONTROL FUNCTIONS

EAU10471

## Main switch/steering lock

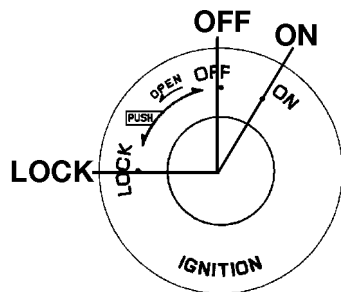

3

The main switch/steering lock controls the ignition and lighting systems, and is used to lock the steering.

### NOTE:

Be sure to use the standard key (black bow) for regular use of the vehicle. To minimize the risk of losing the code re-registering key (red bow), keep it in a safe place and only use it for code re-registering.

EAU10550

### ON

All electrical circuits are supplied with power, the meter lighting, taillight, license plate light and auxiliary lights come on, and the engine can be star-

ted. The key cannot be removed.

### NOTE:

The headlights come on automatically when the engine is started and stay on until the key is turned to "OFF", even if the engine stalls.

EAU10660

### OFF

All electrical systems are off. The key can be removed.

EAU10680

### LOCK

The steering is locked, and all electrical systems are off. The key can be removed.

#### To lock the steering

1. Turn the handlebars all the way to the left.
2. Push the key in from the "OFF" position, and then turn it to "LOCK" while still pushing it.
3. Remove the key.

#### To unlock the steering

Push the key in, and then turn it to "OFF" while still pushing it.

EWA10060

### **WARNING**

Never turn the key to "OFF" or "LOCK" while the vehicle is moving, otherwise the electrical systems will be switched off, which may result in loss of control or an accident. Make sure that the vehicle is stopped before turning the key to "OFF" or "LOCK".





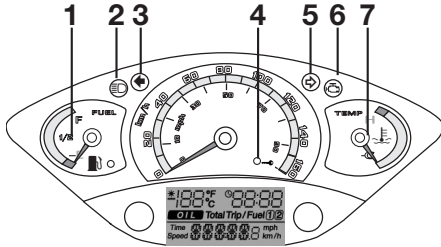

# INSTRUMENT AND CONTROL FUNCTIONS

## Indicators, indicator lights and warning light

EAU33461



1. Fuel level gauge circuit
2. High beam indicator light “”
3. Left turning signal light “”
4. Immobilizer system indicator light “”
5. Right turning signal light “”
6. Engine trouble warning light “”
7. Coolant temperature gauge

EAU11030

## Turn signal indicator lights “” and “”

The corresponding indicator light flashes when the turn signal switch is pushed to the left or right.

EAU11080

## High beam indicator light “”

This indicator light comes on when the high beam of the headlight is switched on.

EAU11350

## Fuel level warning light “”

This warning light comes on when the fuel level drops below approximately 2 L (0.44 US gal) (1.76 Imp.gal). When this occurs, refuel as soon as possible.

The electrical circuit of the warning light can be checked by turning the key to “ON”.

If the warning light does not come on for a few seconds, then go off, have a Yamaha dealer check the electrical circuit.

EAU11480

## Engine trouble warning light “”

This warning light comes on when an electrical circuit monitoring the engine is defective. When this occurs, have a Yamaha dealer check the self-diagnosis system.

The electrical circuit of the warning light can be checked by turning the

key to “ON”. If the warning light does not come on for a few seconds, then go off, have a Yamaha dealer check the electrical circuit.

EAUS1310

## Immobilizer system indicator light “”

The electrical circuit of the indicator light can be checked by turning the key to “ON”.

If the indicator light does not come on for a few seconds, then go off, have a Yamaha dealer check the electrical circuit.

When the key is turned to “OFF”, the indicator light will start flashing indicating the immobilizer system is enabled. After 24 hours have passed, the indicator light will stop flashing, however the immobilizer system is still enabled.

# INSTRUMENT AND CONTROL FUNCTIONS

EAU11590

## Speedometer

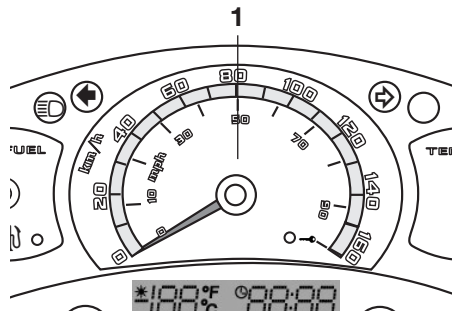



1. Speedometer

The speedometer shows the riding speed.

EAU12110

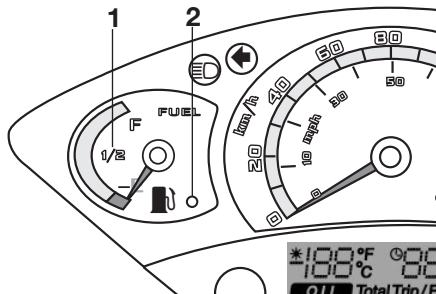
## Fuel gauge



1. Fuel gauge  
2. Fuel level warning light “”

The fuel gauge indicates the amount of fuel in the fuel tank. The needle moves towards “E” (Empty) as the fuel level decreases. When the needle reaches “E”, approximately 2.0L (0.44 USgal) (1.76Impgal) of fuel remain in the fuel tank. If this occurs, refuel as soon as possible.

**NOTE:** \_\_\_\_\_  
Do not allow the fuel tank to empty itself completely.  
\_\_\_\_\_

EAU12171

## Coolant temperature gauge

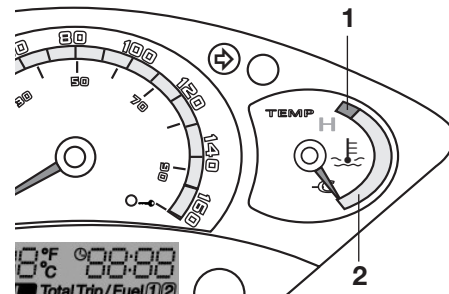

1. Red zone  
2. Temperature gauge

With the key in the “ON” position, the coolant temperature gauge indicates the temperature of the coolant. The coolant temperature varies with changes in the weather and engine load. If the needle reaches or enters the red zone, stop the vehicle and let the engine cool. (See page 6-29.)

**CAUTION:** \_\_\_\_\_  
Do not operate the engine if it is overheated.  
\_\_\_\_\_

ECA10020

# INSTRUMENT AND CONTROL FUNCTIONS

EAUM2050

## Multi-function display

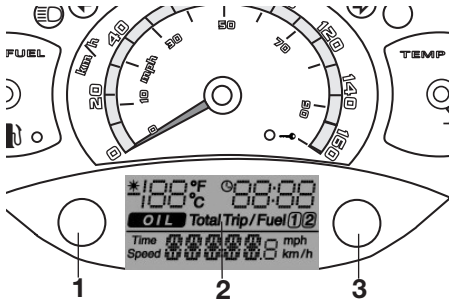

1. "MODE" button
2. Multi-function display
3. "SET" button

The multi-function display is equipped with the following:

- an odometer (which shows the total distance traveled)
- two tripmeters (which show the distance traveled since they were last set to zero, the time passed since the tripmeters were set to zero, and the average speed traveled during this time)
- a fuel reserve tripmeter (which shows the distance traveled since the fuel level warning light came on)
- a clock

- an ambient temperature display
- an oil change indicator (which comes on when the engine oil should be changed)

### NOTE:

- For the UK, the distance traveled is displayed in miles and the temperature reading is displayed in °F.
- For other countries, the distance traveled is displayed in kilometers and the temperature reading is displayed in °C.

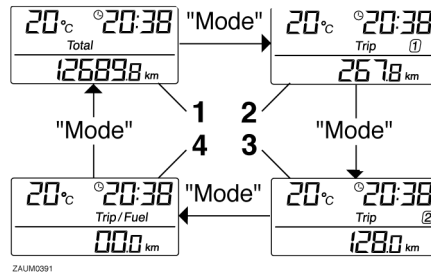

ZALUM0391

1. Total
2. Trip 1
3. Trip 2
4. Trip/Fuel

## Odometer and tripmeter modes

Pushing the "MODE" button switches the display between the odometer mode "Total" and the tripmeter modes "Trip" in the following order: Total → Trip 1 → Trip 2 → Trip/fuel → Total

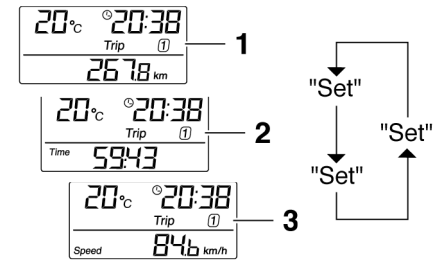

ZALUM0392

1. Distance
2. Time
3. Average speed

### NOTE:

- The Trip/fuel odometer is only activated if the fuel level warning light comes on.
- The Trip 2 odometer is automatically reset after turning the key to "OFF" and two hours have passed.

# INSTRUMENT AND CONTROL FUNCTIONS

Pushing the “SET” button when in the tripmeter mode switches the display between the different tripmeter functions in the following order:

Trip 1 or Trip 2 → Time 1 or 2 → Average speed 1 or 2 → Trip 1 or Trip 2

3

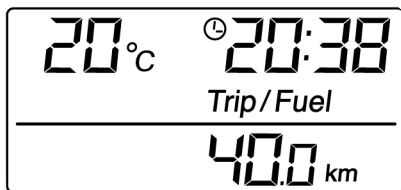

ZALUM0395

If the fuel level warning light comes on (See page 3-3.), the display will automatically change to the fuel reserve tripmeter mode “Trip/fuel” and start counting the distance traveled from that point. In that case, pushing the “MODE” button switches the display between the various tripmeter and odometer modes in the following order:

Trip/Fuel → Trip 1 → Trip 2 → Total → Trip/fuel

To reset a tripmeter, select it by pushing the “MODE” button, and then push the “SET” button for at least one second. If you do not reset the fuel reserve tripmeter manually, it will reset itself automatically and the display will return to the prior mode after refueling and traveling 5 km (3 mi).

## Clock mode

To set the clock:

1. When the display is in the “Total” mode, push the “SET” button for at least two seconds.

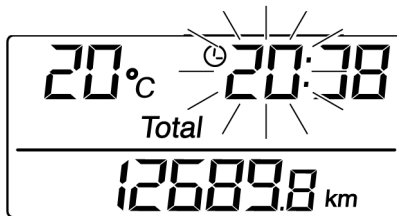

ZALUM0394

2. When the hour digits start flashing, push the “SET” button to set the hours.

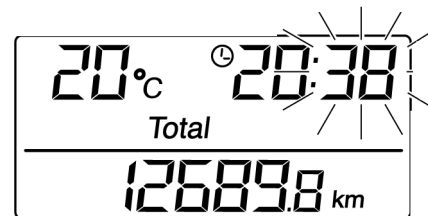

ZALUM0395

3. Push the “MODE” button, and the minute digits will start flashing.
4. Push the “SET” button to set the minutes.
5. Push the “MODE” button and then release it to start the clock. The display will return to the “Total” mode.

# INSTRUMENT AND CONTROL FUNCTIONS

EAU12331

## Ambient temperature display

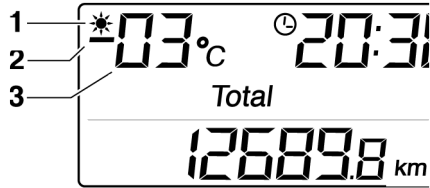

ZAJUM096

1. Frost warning indicator
2. Negative symbol
3. Ambient temperature

This display shows the ambient temperature from -30°C (-22°F) to 50°C (122°F).

The frost warning indicator “\*” automatically comes on if the temperature is lower than 3°C (37.4°F).

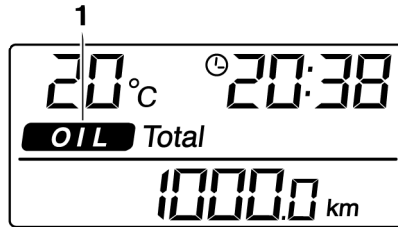

ZAJUM092

1. Service indicator

## Oil change indicator “OIL”

The engine oil should be changed when this indicator comes on. The indicator stays on until it is reset. After changing the engine oil, reset the indicator as follows.

1. While holding the “MODE” and “SET” buttons pushed, turn the key to “ON”.
2. Continue holding the “MODE” and “SET” buttons pushed for two to five seconds.
3. Release the buttons and the oil change indicator will go off.

### NOTE:

- The oil change indicator will come on at the initial 1000 km (600 mi) and every 6000 km (3600 mi) thereafter.
- If the engine oil is changed before the oil change indicator comes on (i.e. before the periodic oil change interval has been reached), the indicator must be reset after the oil change for the next periodic oil change to be indicated at the correct time. After resetting, the indicator will come on for two seconds. If the indicator does not come on, repeat the procedure.

## Anti-theft alarm (optional)

This motorcycle can be equipped with an optional anti-theft alarm by a Yamaha dealer. Contact a Yamaha dealer for more information.

# INSTRUMENT AND CONTROL FUNCTIONS

## Handlebar switches

EAU12343

Press this switch to flash the headlight.

### Pass switch "PASSING"

EAUS1300

EAUS1020

### Dimmer switch "D/D"

Set this switch to "D" for the high beam and to "D" for the low beam. With the headlight on low beam, press this switch downwards to flash the headlight.

### Start switch "⊗"

EAUM1131

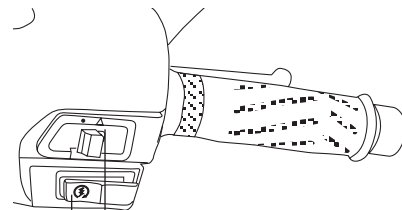

1 2

1. Start switch "⊗"
2. Hazard switch "▲"

### Turn signal switch "↕/↔"

EAU12460

To signal a right-hand turn, push this switch to "↔". To signal a left-hand turn, push this switch to "↕". When released, the switch returns to the center position. To cancel the turn signal lights, push the switch in after it has returned to the center position.

Push this switch while applying the front or rear brake to crank the engine with the starter.

ECA10050

### CAUTION:

**See page 5-1 for starting instructions prior to starting the engine.**

### Horn switch "📢"

EAU12500

Press this switch to sound the horn.

EAUM1990

### Hazard switch "▲", "⊙"

With the key in the "⊙" position, set this switch to "▲" to turn on the hazard lighting (simultaneous flashing of all turn signal lights). To turn off the hazard lighting, set this switch to "⊙" and, then turn the key to "⊗".

3

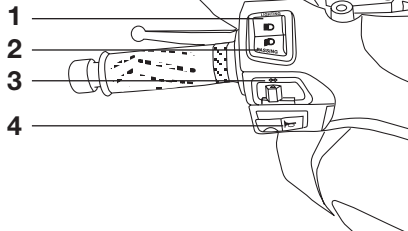

1. Dimmer switch "D/D"
2. Pass switch "PASS"
3. Turn signal switch "↕/↔"
4. Horn switch "📢"

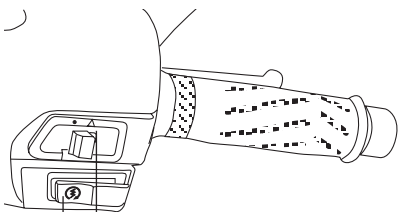

1 2

1. Start switch "⊗"
2. Hazard switch "▲"

# INSTRUMENT AND CONTROL FUNCTIONS

## NOTE:

Even if the key is turned from “○” to “⊗” with the hazard lighting on, the hazard lighting will continue to flash regardless of the hazard switch position. To cancel the hazard lighting, the key must be turned to “○” and the hazard switch must be set to the “⊙” position.

The hazard lighting is used in case of an emergency or to warn other drivers when your scooter is stopped where it might be a traffic hazard.

ECA10060

## CAUTION:

**Do not use the hazard light for an extended length of time, otherwise the battery may discharge.**

EAU12900

## Front brake lever

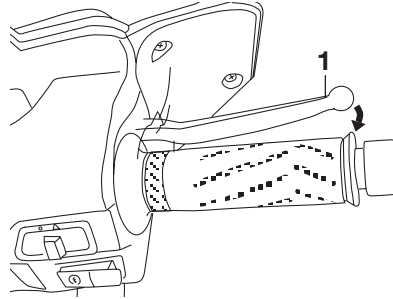

1. Front brake lever

The front brake lever is located on the right handlebar grip. To apply the front brake, pull this lever toward the handlebar grip.

EAU12950

## Rear brake lever

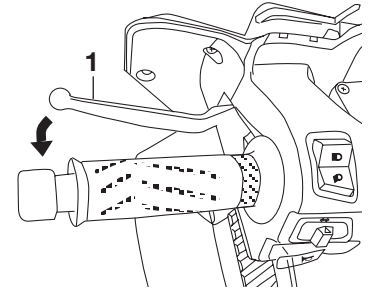

1. Rear brake lever

The rear brake lever is located on the left handlebar grip. To apply the rear brake, pull this lever toward the handlebar grip.

# INSTRUMENT AND CONTROL FUNCTIONS

EAU13161

## Fuel tank cap

### To open the fuel tank cap

1. Open the lid by sliding the lever forward, and then pull the lever up.

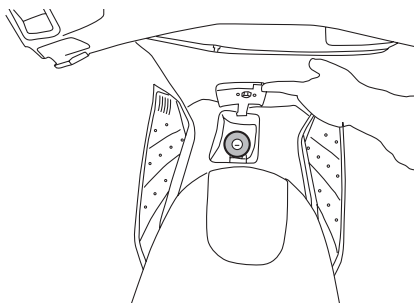

2. Insert the key into the lock and turn it clockwise. The lock will be released and the fuel tank cap can be removed.

### To install the fuel tank cap

1. Align the match marks, insert the fuel tank cap into the tank opening, and then push down on the cap.
2. Turn the key counterclockwise to the original position, and then remove it.
3. Close the lid.

## **WARNING**

Be sure that the fuel tank cap is properly installed and locked before riding the scooter.

EWA11120

## Fuel

Make sure that there is sufficient fuel in the tank.

EAU13230

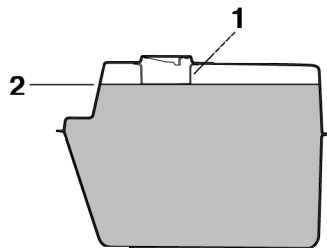

ZAJM0020

1. Fuel tank
2. Fuel level

EWA10990

## **WARNING**

Since gasoline is flammable, the following precautions must be observed.

- Stop the engine before refueling.

- Never attempt to refuel the scooter while smoking or near an open flame.
- Take special care not to spill gasoline over the engine or muffler when refueling immediately after operation.
- Before starting the engine, quickly wipe off any gasoline spilled on the engine or muffler.

ECA10070

## **CAUTION:**

Immediately wipe off spilled fuel with a clean, dry, soft cloth, since fuel may deteriorate painted surfaces or plastic parts.

EAU33500

**Recommended fuel:**  
REGULAR UNLEADED GASOLINE ONLY

**Fuel tank capacity:**  
12,5 L (2,75 US gal) (11 Imp.gal)

**Fuel reserve amount (when the fuel level warning symbol comes on):**  
2 L (0,44 US gal) (1,76 Imp.gal)



# INSTRUMENT AND CONTROL FUNCTIONS

ECA11400

EAU13431

EAU13931

## CAUTION:

**Use only unleaded gasoline. The use of leaded gasoline will cause severe damage to internal engine parts, such as the valves and piston rings, as well as to the exhaust system.**

Your Yamaha engine has been designed to use regular unleaded gasoline with a research octane number of 91 or higher. If knocking (or pinging) occurs, use a gasoline of a different brand or premium unleaded fuel. Use of unleaded fuel will extend spark plug life and reduce maintenance costs.

## Catalytic converter

This model is equipped with a catalytic converter in the exhaust system.

EWA10860

## WARNING

**The exhaust system is hot after operation. Make sure that the exhaust system has cooled down before doing any maintenance work.**

ECA10700

## CAUTION:

**The following precautions must be observed to prevent a fire hazard or other damages.**

- **Use only unleaded gasoline. The use of leaded gasoline will cause unreparable damage to the catalytic converter.**
- **Never park the vehicle near possible fire hazards such as grass or other materials that easily burn.**
- **Do not allow the engine to idle too long.**

## Seat

### To open the seat

1. Place the scooter on the centerstand.
2. Insert the key into the main switch, and then turn it counterclockwise.

### NOTE:

Do not push inward when turning the key.

3. Fold the seat up.

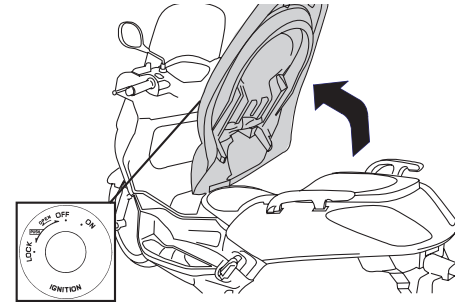

### To close the seat

1. Fold the seat down, and then push it down to lock it in place.
2. Remove the key from the main switch if the scooter will be left unattended.

# INSTRUMENT AND CONTROL FUNCTIONS

## NOTE:

Make sure that the seat is properly secured before riding.

EAU14540

## Front storage compartment

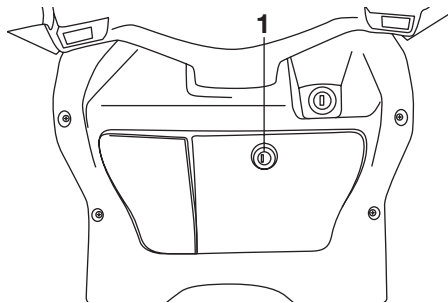

1. Lock

## To open the storage compartment

Insert the key into the lock, turn it clockwise, and then pull on it to open the storage compartment lid.

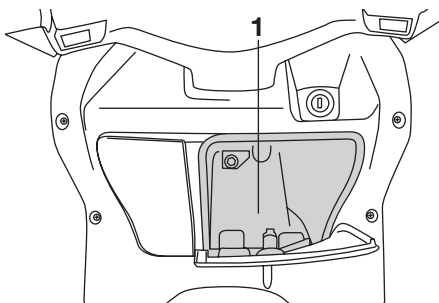

1.Storage compartment

## To close the storage compartment

Push the storage compartment lid into the original position, and then remove the key.

EWA10960

## ⚠ WARNING

- Do not exceed the load limit of 1 kg (2.205 lb) for the storage compartment.
- Do not exceed the maximum load of 189 kg (416.75 lb) for the vehicle.

EAU14451

## Storage compartment

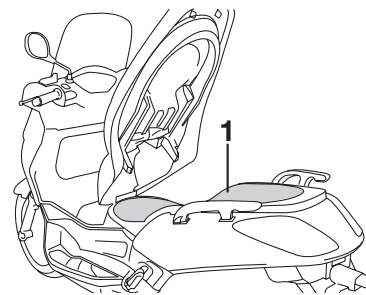

1.Storage compartment

The storage compartment is located under the seat. (See page 3-11.)

EWA10961

## ⚠ WARNING

- Do not exceed the load limit of 5 kg (11.02 lb) for the storage compartment.
- Do not exceed the maximum load of 189 kg (416.75 lb) for the vehicle.

When storing the owner's manual or other documents in the storage compartment, be sure to wrap them in a plastic bag so that they will not get wet. When washing the vehicle, be careful not to let any water enter the storage compartment.

EAU14880

## Adjusting the shock absorber assemblies

Each shock absorber assembly is equipped with a spring preload adjusting ring.

ECA10100

### CAUTION:

Never attempt to turn an adjusting mechanism beyond the maximum or minimum settings.

EWA10210

### WARNING

Always adjust both shock absorber assemblies equally, otherwise poor handling and loss of stability may result.

Adjust the spring preload as follows.

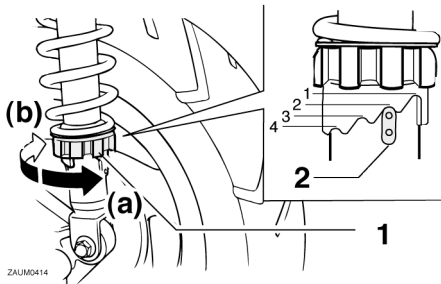

1. Adjusting ring 2. Position indicator

To increase the spring preload and thereby harden the suspension, turn the adjusting ring on each shock absorber assembly in direction (a). To decrease the spring preload and thereby soften the suspension, turn the adjusting ring on each shock absorber assembly in direction (b).

### NOTE:

Align the appropriate notch in the adjusting ring with the position indicator on the shock absorber.

#### Spring preload setting:

Minimum (soft):

1

Standard:

1

Maximum (hard):

4

EAU15301

## Sidestand

The sidestand is located on the left side of the frame. Raise the sidestand or lower it with your foot while holding the motorcycle upright.

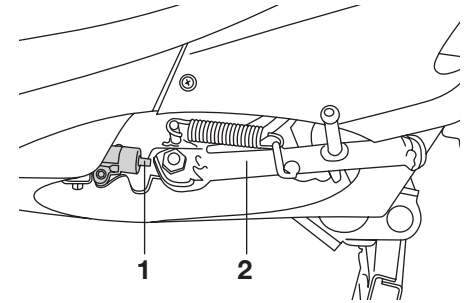

1. Sidestand switch

2. Sidestand

### NOTE:

The built-in sidestand switch is part of the ignition circuit cut-off system, which cuts the ignition in certain situations. (See further down for an explanation of the ignition circuit cut-off system.)

# INSTRUMENT AND CONTROL FUNCTIONS

---

EWA10240

## **WARNING**

**The vehicle must not be ridden with the sidestand down, or if the sidestand cannot be properly moved up (or does not stay up), otherwise the sidestand could contact the ground and distract the operator, resulting in a possible loss of control. Yamaha's ignition circuit cut-off system has been designed to assist the operator in fulfilling the responsibility of raising the sidestand before starting off. Therefore, check this system regularly as described below and have a Yamaha dealer repair it if it does not function properly.**

---

**3**

# INSTRUMENT AND CONTROL FUNCTIONS

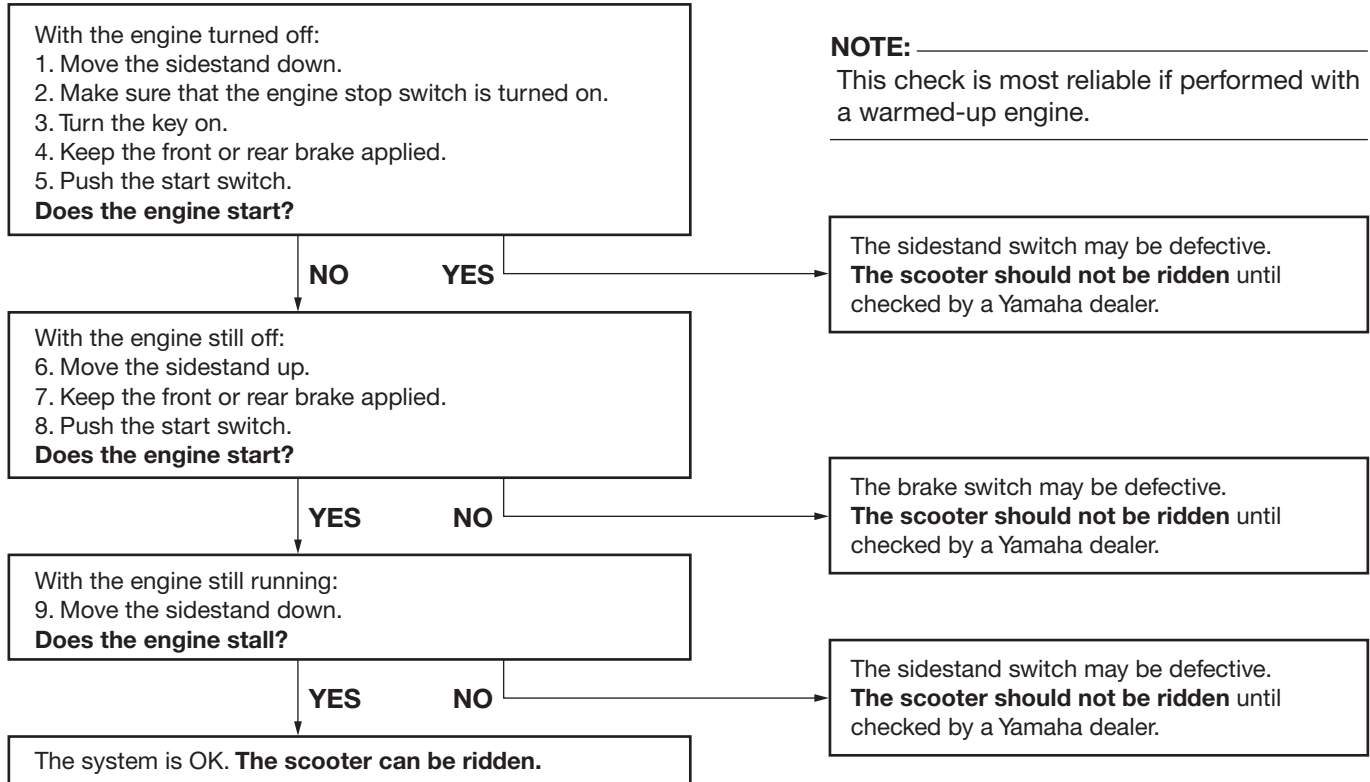

# PRE-OPERATION CHECKS

---

EAU15591

The condition of a vehicle is the owner's responsibility. Vital components can start to deteriorate quickly and unexpectedly, even if the vehicle remains unused (for example, as a result of exposure to the elements). Any damage, fluid leakage or loss of tire air pressure could have serious consequences. Therefore, it is very important, in addition to a thorough visual inspection, to check the following points before each ride.

4

**NOTE:** \_\_\_\_\_

Pre-operation checks should be made each time the vehicle is used. Such an inspection can be accomplished in a very short time; and the added safety it assures is more than worth the time involved.

---

EWA11150

**⚠ WARNING** \_\_\_\_\_

**If any item in the Pre-operation check list is not working properly, have it inspected and repaired before operating the vehicle.**

---

# PRE-OPERATION CHECKS

EAU15603

## Pre-operation check list

ITEM	CHECKS	PAGE
<b>Fuel</b>	<ul style="list-style-type: none"><li>• Check fuel level in fuel tank.</li><li>• Refuel if necessary.</li><li>• Check fuel line for leakage.</li></ul>	3-4, 3-10
<b>Engine oil</b>	<ul style="list-style-type: none"><li>• Check oil level in engine.</li><li>• If necessary, add recommended oil to specified level.</li><li>• Check vehicle for oil leakage.</li></ul>	6-8
<b>Final transmission oil</b>	<ul style="list-style-type: none"><li>• Check vehicle for oil leakage.</li></ul>	6-10
<b>Coolant</b>	<ul style="list-style-type: none"><li>• Check coolant level in reservoir.</li><li>• If necessary, add recommended coolant to specified level.</li><li>• Check cooling system for leakage.</li></ul>	3-4, 6-11
<b>Front brake</b>	<ul style="list-style-type: none"><li>• Check operation.</li><li>• If soft or spongy, have Yamaha dealer bleed hydraulic system.</li><li>• Check brake pads for wear.</li><li>• Replace if necessary.</li><li>• Check fluid level in reservoir.</li><li>• If necessary, add recommended brake fluid to specified level.</li><li>• Check hydraulic system for leakage.</li></ul>	3-9, 5-2, 6-17
<b>Rear brake</b>	<ul style="list-style-type: none"><li>• Check operation.</li><li>• If soft or spongy, have Yamaha dealer bleed hydraulic system.</li><li>• Check brake pads for wear.</li><li>• Replace if necessary.</li><li>• Check fluid level in reservoir.</li><li>• If necessary, add recommended brake fluid to specified level.</li><li>• Check hydraulic system for leakage.</li></ul>	3-9, 5-2, 6-17
<b>Throttle grip</b>	<ul style="list-style-type: none"><li>• Make sure that operation is smooth.</li><li>• Check cable free play.</li><li>• If necessary, have Yamaha dealer adjust cable free play and lubricate cable and grip housing.</li></ul>	5-2, 6-14, 6-19
<b>Wheels and tires</b>	<ul style="list-style-type: none"><li>• Check for damage.</li><li>• Check tire condition and tread depth.</li><li>• Check air pressure.</li><li>• Correct if necessary.</li></ul>	6-15 ~ 6-17

# PRE-OPERATION CHECKS

ITEM	CHECKS	PAGE
Brake levers	<ul style="list-style-type: none"><li>• Make sure that operation is smooth.</li><li>• Lubricate lever pivoting points if necessary.</li></ul>	3-9, 6-20
Centerstand, sidestand	<ul style="list-style-type: none"><li>• Make sure that operation is smooth.</li><li>• Lubricate pivots if necessary.</li></ul>	6-20
Chassis fasteners	<ul style="list-style-type: none"><li>• Make sure that all nuts, bolts and screws are properly tightened.</li><li>• Tighten if necessary.</li></ul>	—
Instruments, lights, signals and switches	<ul style="list-style-type: none"><li>• Check operation.</li><li>• Correct if necessary.</li></ul>	—
Sidestand switch	<ul style="list-style-type: none"><li>• Check operation of ignition circuit cut-off system.</li><li>• If system is defective, have Yamaha dealer check vehicle.</li></ul>	3-13 ~ 3-15



# OPERATION AND IMPORTANT RIDING POINTS

EAU15970  
EWA11250

## **WARNING**

- Become thoroughly familiar with all operating controls and their functions before riding. Consult a Yamaha dealer regarding any control or function that you do not thoroughly understand.
- Never start the engine or operate it in a closed area for any length of time. Exhaust fumes are poisonous, and inhaling them can cause loss of consciousness and death within a short time. Always make sure that there is adequate ventilation.
- For safety, always start the engine with the centerstand down.
- When the centerstand is down and the engine is idling, keep your hands and feet away from the rear wheel.

EAUM1210

## Starting a cold engine

ECA10250

### **CAUTION:**

See page 5-3 for engine break-in instructions prior to operating the vehicle for the first time.

1. Turn the key to “O”.
2. Close the throttle completely.

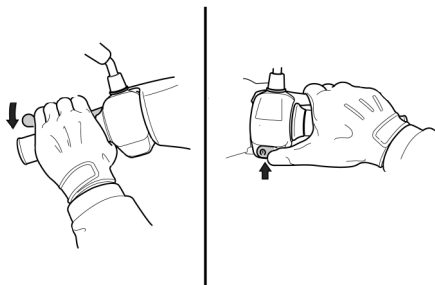

3. Start the engine by pushing the start switch while applying the front or rear brake.

### **NOTE:**

If the engine fails to start, release the start switch, wait a few seconds, and then try again. Each starting attempt should be as short as possible to preserve the battery. Do not crank the engine more than 10 seconds on any one attempt.

ECA11040

### **CAUTION:**

For maximum engine life, never accelerate hard when the engine is cold!

# OPERATION AND IMPORTANT RIDING POINTS

EAU16760

## Starting off

### NOTE:

Before starting off, allow the engine to warm up.

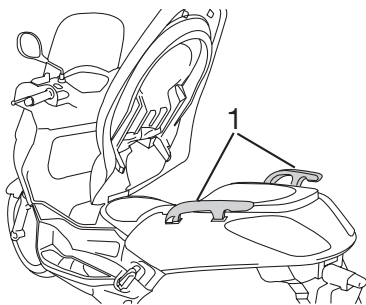

1. Grab bar

1. While pulling the rear brake lever with your left hand and holding the grab bar with your right hand, push the scooter off the centerstand.
2. Sit astride the seat, and then adjust the rear view mirrors.
3. Switch the turn signal on.
4. Check for oncoming traffic, and then slowly turn the throttle grip (on the right) in order to take off.
5. Switch the turn signal off.

## Acceleration and deceleration

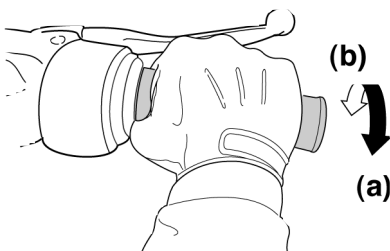

ZAUM0199

The speed can be adjusted by opening and closing the throttle. To increase the speed, turn the throttle grip in direction (a). To reduce the speed, turn the throttle grip in direction (b).

EAU16780

## Braking

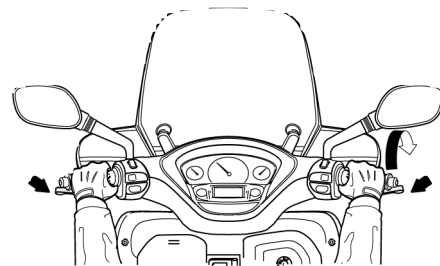

ZAUM0472

1. Close the throttle completely.
2. Apply both front and rear brakes simultaneously while gradually increasing the pressure.

EWA10300

### **WARNING**

- Avoid braking hard or suddenly (especially when leaning over to one side), otherwise the scooter may skid or overturn.
- Railroad crossings, streetcar rails, iron plates on road construction sites, and manhole covers become extremely slippery when wet. Therefore, slow down when approaching such areas and cross them with caution.

# OPERATION AND IMPORTANT RIDING POINTS

- **Keep in mind that braking on a wet road is much more difficult.**
- **Ride slowly down a hill, as braking downhill can be very difficult.**

## Tips for reducing fuel consumption

Fuel consumption depends largely on your riding style. Consider the following tips to reduce fuel consumption:

- Avoid high engine speeds during acceleration.
- Avoid high engine speeds with no load on the engine.
- Turn the engine off instead of letting it idle for an extended length of time (e.g., in traffic jams, at traffic lights or at railroad crossings).

## Engine break-in

There is never a more important period in the life of your engine than the period between 0 and 1600 km (1000 mi). For this reason, you should read the following material carefully. Since the engine is brand new, do not put an excessive load on it for the first 1600 km (1000 mi). The various parts in the engine wear and polish themselves to the correct operating clearances. During this period, prolonged

EAU16820

full-throttle operation or any condition that might result in engine overheating must be avoided.

EAM2010

### 0~1000 km (0~600 mi)

Avoid prolonged operation above 1/3 throttle.

### 1000~1600 km (600~1000 mi)

Avoid prolonged operation above 1/2 throttle.

ECA11660

### CAUTION:

**After 1000 km (600 mi) of operation, be sure to replace the engine oil and final transmission oil.**

### 1600 km (1000 mi) and beyond

The vehicle can now be operated normally.

ECA10270

### CAUTION:

**If any engine trouble should occur during the engine break-in period, immediately have a Yamaha dealer check the vehicle.**

# OPERATION AND IMPORTANT RIDING POINTS

---

EAU17212

## Parking

When parking, stop the engine, and then remove the key from the main switch.

EWA10310

### **WARNING**

- Since the engine and exhaust system can become very hot, park in a place where pedestrians or children are not likely to touch them.
- Do not park on a slope or on soft ground, otherwise the vehicle may overturn.

5

ECA10380

### **CAUTION:**

Never park in an area where there are fire hazards such as grass or other flammable materials.

# PERIODIC MAINTENANCE AND MINOR REPAIR

EAU17280

Safety is an obligation of the owner. Periodic inspection, adjustment and lubrication will keep your vehicle in the safest and most efficient condition possible. The most important points of inspection, adjustment, and lubrication are explained on the following pages.

The intervals given in the periodic maintenance and lubrication chart should be simply considered as a general guide under normal riding conditions. However, DEPENDING ON THE WEATHER, TERRAIN, GEOGRAPHICAL LOCATION, AND INDIVIDUAL USE, THE MAINTENANCE INTERVALS MAY NEED TO BE SHORTENED.

EWA10320

## **⚠ WARNING**

**If you are not familiar with maintenance work, have a Yamaha dealer do it for you.**

EWA10330

## **⚠ WARNING**

**This scooter is designed for use on paved roads only. If this scooter is operated in abnormally dusty, muddy or wet conditions, the air filter element should be cleaned or replaced more frequently, otherwise rapid engine wear may result. Consult a Yamaha dealer for proper maintenance intervals.**

EAU17380

## Owner's tool kit

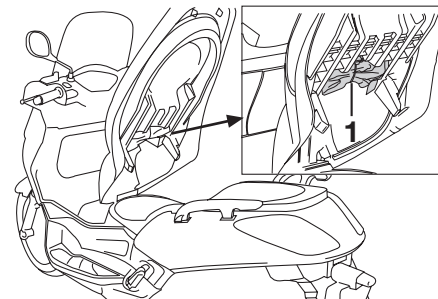

1. Owner's tool kit

The owner's tool kit is located under the seat. (See page 3-11.)

The service information included in this manual and the tools provided in the owner's tool kit are intended to assist you in the performance of preventive maintenance and minor repairs. However, additional tools such as a torque wrench may be necessary to perform certain maintenance work correctly.

# PERIODIC MAINTENANCE AND MINOR REPAIR

---

---

**NOTE:** \_\_\_\_\_

If you do not have the tools or experience required for a particular job, have a Yamaha dealer perform it for you.

---

EWA10350

 **WARNING**

**Modifications not approved by Yamaha may cause loss of performance and render the vehicle unsafe for use. Consult a Yamaha dealer before attempting any changes.**

---

# PERIODIC MAINTENANCE AND MINOR REPAIR

EAU17705

## Periodic maintenance and lubrication chart

### NOTE:

- The annual checks must be performed every year, except if a kilometer-based maintenance is performed instead.
- From 30000 km, repeat the maintenance intervals starting from 6000 km.
- Items marked with an asterisk should be performed by a Yamaha dealer as they require special tools, data and technical skills.

NO.	ITEM	CHECK OR MAINTENANCE JOB	ODOMETER READING (x 1000 Km)					ANNUAL CHECK
			1	6	12	18	24	
1	* Fuel line	• Check fuel and vacuum hoses for cracks or damage.		√	√	√	√	√
2	Spark plug	• Check condition. • Clean and regap.		√		√		
		• Replace.			√		√	
3	* Valves	• Check valve clearance. • Adjust.			√		√	
4	Air filter element	• Replace.	Every 20000 Km					
5	* V-Belt	• Replace.	Every 20000 Km					
6	* Front brake	• Check operation, fluid level and vehicle for fluid leakage.	√	√	√	√	√	√
		• Replace brake pads.	Whenever worn to the limit					
7	* Rear brake	• Check operation, fluid level and vehicle for fluid leakage.	√	√	√	√	√	√
		• Replace brake pads.	Whenever worn to the limit					

# PERIODIC MAINTENANCE AND MINOR REPAIR

NO.	ITEM	CHECK OR MAINTENANCE JOB	ODOMETER READING (x 1000 Km)					ANNUAL CHECK
			1	6	12	18	24	
8	* Brake hoses	<ul style="list-style-type: none"> <li>• Check for cracks or damage.</li> <li>• Replace.</li> </ul>		√	√	√	√	√
9	* Wheels	<ul style="list-style-type: none"> <li>• Check runout and for damage.</li> </ul>		√	√	√	√	
10	* Tires	<ul style="list-style-type: none"> <li>• Check tread depth and for damage.</li> <li>• Replace if necessary.</li> <li>• Check air pressure.</li> <li>• Correct if necessary.</li> </ul>		√	√	√	√	√
11	* Wheel bearings	<ul style="list-style-type: none"> <li>• Check bearing for looseness or damage.</li> </ul>		√	√	√	√	
12	* Steering bearings	<ul style="list-style-type: none"> <li>• Check bearing play and steering for roughness.</li> <li>• Lubricate with lithium-soap-based grease.</li> </ul>	√	√	√	√	√	
13	* Chassis fasteners	<ul style="list-style-type: none"> <li>• Make sure that all nuts, bolts and screws are properly tightened.</li> </ul>		√	√	√	√	√
14	Sidestand, centerstand	<ul style="list-style-type: none"> <li>• Check operation.</li> <li>• Lubricate.</li> </ul>		√	√	√	√	√
15	* Sidestand switch	<ul style="list-style-type: none"> <li>• Check operation.</li> </ul>	√	√	√	√	√	√
16	* Front fork	<ul style="list-style-type: none"> <li>• Check operation and for oil leakage.</li> </ul>		√	√	√	√	
17	* Shock absorber assemblies	<ul style="list-style-type: none"> <li>• Check operation and shock absorbers for oil leakage.</li> </ul>		√	√	√	√	
18	* Fuel injection	<ul style="list-style-type: none"> <li>• Check engine idle speed.</li> </ul>	√	√	√	√	√	√
19	Engine oil	<ul style="list-style-type: none"> <li>• Change. (See page 6-8)</li> <li>• Check oil level/top up.</li> </ul>	√	When the oil change indicator light comes on (every 6000 km)				
20	Engine oil filter element	<ul style="list-style-type: none"> <li>• Replace.</li> </ul>	√		√		√	
21	* Cooling system	<ul style="list-style-type: none"> <li>• Check coolant level and vehicle for coolant leakage.</li> <li>• Change.</li> </ul>		√	√	√	√	√
				Every 3 years				



# PERIODIC MAINTENANCE AND MINOR REPAIR

NO.	ITEM	CHECK OR MAINTENANCE JOB	ODOMETER READING (x 1000 Km)					ANNUAL CHECK
			1	6	12	18	24	
22	Final gear oil	• Check vehicle for oil leakage.	√	√		√		
		• Change.	√		√		√	
23	* V-belt case air filter elements	• Clean.	Every 6000 km					
		• Replace.	Every 20000 km					
24	* Front and rear brake switches	• Check operation.	√	√	√	√	√	√
25	Moving parts and cables	• Lubricate.		√	√	√	√	√
26	* Throttle grip housing and cable	• Check operation and free play. • Adjust the throttle cable free play if necessary. • Lubricate the throttle grip housing and cable.		√	√	√	√	√
27	* Muffler and exhaust pipe	• Check the screw clamp for looseness.	√	√	√	√	√	
28	* Lights, signals and switches	• Check operation. • Adjust headlight beam.	√	√	√	√	√	√

EAU18660

**NOTE:**

- The air filter needs more frequent service if you are riding in unusually wet or dusty areas.
- Hydraulic brake service
  - Regularly check and, if necessary, correct the brake fluid level.
  - Every two years replace the internal components of the brake master cylinder and caliper, and change the brake fluid.
  - Replace the brake hoses every four years and if cracked or damaged.

# PERIODIC MAINTENANCE AND MINOR REPAIR

## Removing and installing cowlings and panels

The cowlings and panels shown need to be removed to perform some of the maintenance jobs described in this chapter. Refer to this section each time a cowling or panel needs to be removed and installed.

EAU18712

### Cowling B

To remove the cowling

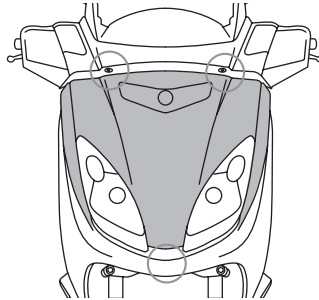

Screws

Remove the screws, and then take the cowling off.

To install the cowling

Place the cowling in the original position, and then install the screws.

EAU18790

### Cowling A

To remove the cowling

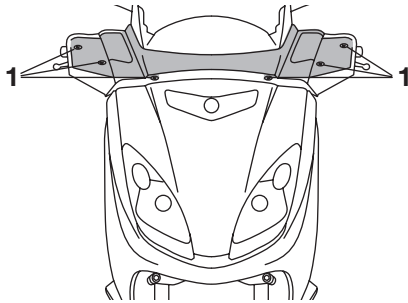

1. Screws x 6

EAUM1250

### Panel A

To remove the panel

1. Open the storage compartment. (See page 3-12.)

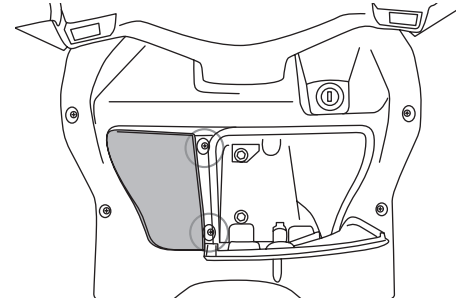

Screws

2. Remove the screw, and then take the panel off.

To install the panel

1. Place the panel in the original position, and then install the screw.
2. Close the storage compartment.

# PERIODIC MAINTENANCE AND MINOR REPAIR

EAUS1280

## Checking the spark plug

The spark plug is an important engine component, which is easy to check. Since heat and deposits will cause any spark plug to slowly erode, the spark plug should be removed and checked in accordance with the periodic maintenance and lubrication chart. In addition, the condition of the spark plug can reveal the condition of the engine.

### To remove the spark plug

1. Open the seat. (See page 3-11.)
2. Remove the storage compartment under the seat by removing the bolts.

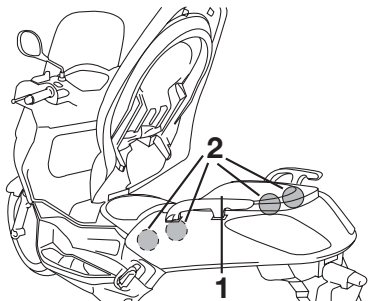

1. Storage compartment
2. Screws

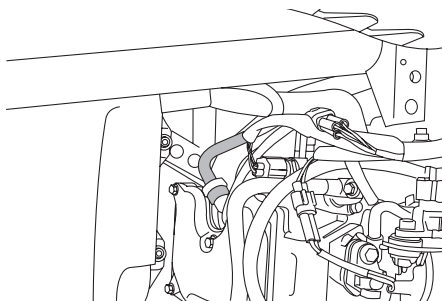

3. Remove the spark plug cap.

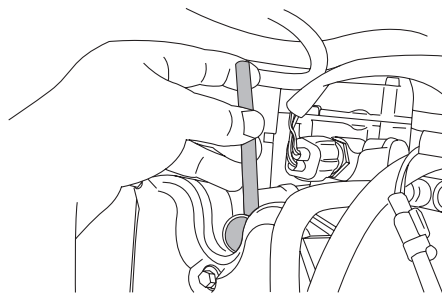

4. Remove the spark plug as shown, with the spark plug wrench included in the owner's tool kit.

### To check the spark plug

1. Check that the porcelain insulator around the center electrode of the spark plug is a medium-to-light tan (the ideal color when the motorcycle is ridden normally).

### NOTE:

If the spark plug shows a distinctly different color, the engine could be defective. Do not attempt to diagnose such problems yourself. Instead, have a Yamaha dealer check the motorcycle.

2. Check the spark plug for electrode erosion and excessive carbon or other deposits, and replace it if necessary.

**Specified spark plug:**  
NGK / CPR 9EA-9

# PERIODIC MAINTENANCE AND MINOR REPAIR

EAUM1550

## To install the spark plug

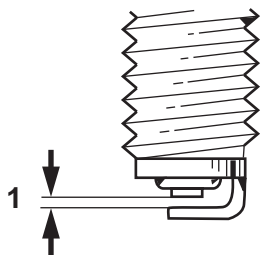

ZAUUM0037

### 1. Spark plug gap

1. Measure the spark plug gap with a wire thickness gauge and, if necessary, adjust the gap to specification.

#### Spark plug gap:

0.8 - 0.9 mm (0.031 - 0.035 in)

2. Clean the surface of the spark plug gasket and its mating surface, and then wipe off any grime from the spark plug threads.
3. Install the spark plug with the spark plug wrench, and then tighten it to the specified torque.

#### Tightening torque:

Spark plug:

12.5 Nm (1.25m•kgf, 9.05 ft•lbf)

## NOTE:

If a torque wrench is not available when installing a spark plug, a good estimate of the correct torque is 1/4~1/2 turn past finger tight. However, the spark plug should be tightened to the specified torque as soon as possible.

4. Install the spark plug cap.
5. Install the storage compartment by installing the bolts.
6. Close the seat.

## Engine oil

The engine oil level should be checked before each ride. In addition, the oil must be changed at the intervals specified in the periodic maintenance and lubrication chart and when the service indicator light comes on.

### To check the engine oil level

1. Place the scooter on the centerstand.

## NOTE:

Make sure that the scooter is positioned straight up when checking the oil level. A slight tilt to the side can result in a false reading.

2. Start the engine, warm it up for several minutes, and then turn it off.

# PERIODIC MAINTENANCE AND MINOR REPAIR

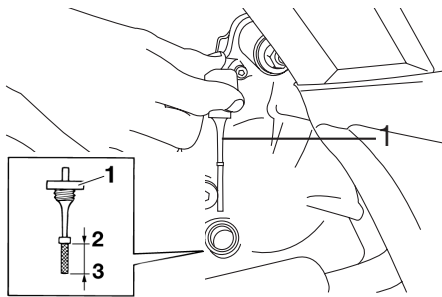

1. Engine oil filler cap
2. Maximum level mark
3. Minimum level mark

3. Wait a few minutes until the oil settles, remove the oil filler cap, wipe the dipstick clean, insert it back into the oil filler hole (without screwing it in), and then remove it again to check the oil level.

**NOTE:** \_\_\_\_\_  
The engine oil should be between the minimum and maximum level marks.

4. If the engine oil is below the minimum level mark, add sufficient oil of the recommended type to raise it to the correct level.
5. Insert the dipstick into the oil filler

hole, and then tighten the oil filler cap.

## To change the engine oil

1. Start the engine, warm it up for several minutes, and then turn it off.
2. Place an oil pan under the engine to collect the used oil.

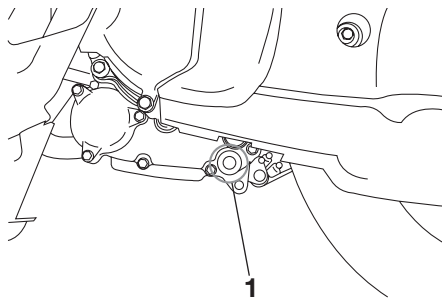

1. Engine oil drain bolt

3. Remove the engine oil filler cap and the engine oil drain bolt to drain the oil from the crankcase.
4. Check the washer for damage and replace it if necessary.

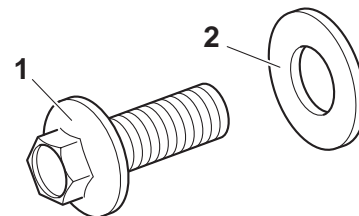

1. Engine oil drain bolt
2. Washer

5. Install the washer and the engine oil drain bolt, and then tighten the drain bolt to the specified torque.

### Tightening torque:

Engine oil drain bolt:  
20 Nm (2.0 m•kgf, 14.5 ft•lbf)

**NOTE:** \_\_\_\_\_  
Make sure that the washer is properly seated.

6. Add the specified amount of the recommended engine oil, and then install and tighten the oil filler cap.

# PERIODIC MAINTENANCE AND MINOR REPAIR

## Recommended engine oil:

See page 8-1.

## Oil change quantity:

1.4 L (1.48 US qt) (1.23 Imp.qt)

ECA11670

## CAUTION:

- Do not use oils with a diesel specification of “CD” or oils of a higher quality than specified. In addition, do not use oils labeled “ENERGY CONSERVING II” or higher.
- Be sure no foreign material enters the crankcase.

7. Start the engine, and then let it idle for several minutes while checking it for oil leakage. If oil is leaking, immediately turn the engine off and check for the cause.
8. Reset the service indicator. (See page 3-7.)

EAU20060

## Final transmission oil

The final transmission case must be checked for oil leakage before each ride. If any leakage is found, have a Yamaha dealer check and repair the scooter. In addition, the final transmission oil must be changed as follows at the intervals specified in the periodic maintenance and lubrication chart.

1. Start the engine, warm it up by riding the scooter for several minutes, and then stop the engine.
2. Place the scooter on the centerstand.
3. Place an oil pan under the final transmission case to collect the used oil.

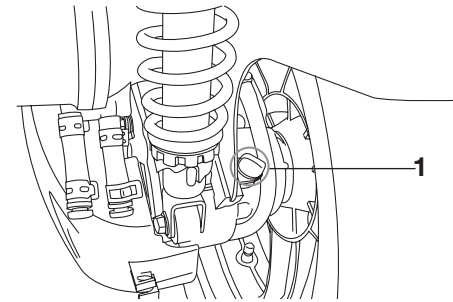

1. Final transmission oil filler cap

4. Remove the oil filler cap and drain bolt to drain the oil from the final transmission case.

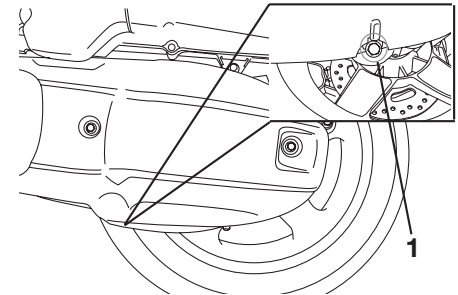

1. Final transmission oil drain bolt

5. Install the final transmission oil drain bolt, and then tighten it to the specified torque.

# PERIODIC MAINTENANCE AND MINOR REPAIR

## Tightening torque:

Final transmission oil drain bolt:  
20 Nm (2.0 m•kgf, 14.5 ft•lbf)

6. Add the specified amount of the recommended final transmission oil, and then install and tighten the oil filler cap.

## Recommended final transmission oil:

See page 8-1.

## Oil quantity:

0.21 L (0.22 US qt) (0.18 Imp.qt)

EWA11310

## WARNING

- Make sure that no foreign material enters the final transmission case.
  - Make sure that no oil gets on the tire or wheel.
7. Check the final transmission case for oil leakage. If oil is leaking, check for the cause.

## Coolant

The coolant level should be checked before each ride. In addition, the coolant must be changed at the intervals specified in the periodic maintenance and lubrication chart.

EAU20070

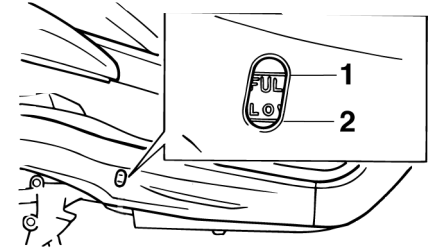

EAUS1270

## To check the coolant level

1. Place the vehicle on a level surface and hold it in an upright position.

1. Maximum level mark
2. Minimum level mark

2. Check the coolant level through the check window.

## NOTE:

- The coolant level must be checked on a cold engine since the level varies with engine temperature.
- Make sure that the vehicle is positioned straight up when checking the coolant level. A slight tilt to the side can result in a false reading.

## NOTE:

The coolant should be between the minimum and maximum level marks.

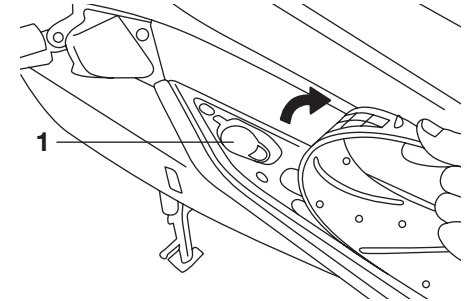

1. Coolant reservoir cap

# PERIODIC MAINTENANCE AND MINOR REPAIR

3. If the coolant is at or below the minimum level mark, remove the right floorboard mat by pulling it up.
4. Open the reservoir cap, and then add coolant to the maximum level mark.

**Coolant reservoir capacity:**  
0.26 L (0.28 US qt) (0.23 Imp.qt)

ECA10470

## CAUTION:

- If coolant is not available, use distilled water or soft tap water instead. Do not use hard water or salt water since it is harmful to the engine.
- If water has been used instead of coolant, replace it with coolant as soon as possible, otherwise the engine may not be sufficiently cooled and the cooling system will not be protected against frost and corrosion.
- If water has been added to the coolant, have a Yamaha dealer check the antifreeze content of the coolant as soon as possible, otherwise the effective-

**ness of the coolant will be reduced.**

EWA10380

## **WARNING**

**Never attempt to remove the radiator cap when the engine is hot.**

5. Close the reservoir cap.
6. Place the floorboard mat in the original position and push it downward to secure it.

EAU33030

## Changing the coolant

EWA10380

## **WARNING**

**Never attempt to remove the radiator cap when the engine is hot.**

The coolant must be changed at the intervals specified in the periodic maintenance and lubrication chart. Have a Yamaha dealer change the coolant.

EAUM1320

## Air filter and V-belt case air filter elements

The air filter and the V-belt case air filter elements should be cleaned at the intervals specified in the periodic maintenance and lubrication chart. Clean both filter elements more frequently if you are riding in unusually wet or dusty areas.

### Replace the air filter element

1. Place the scooter on the centerstand.
2. Remove the air filter case cover by removing the screws.

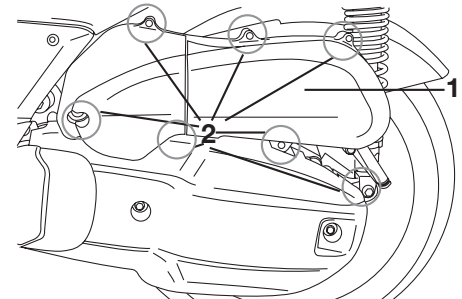

1. Air filter case cover
2. Screw



# PERIODIC MAINTENANCE AND MINOR REPAIR

3. Pull the air filter element out.

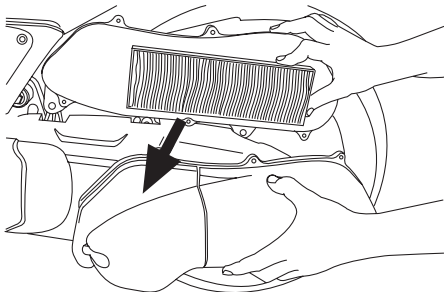

4. Lightly tap the air filter element to remove most of the dust and dirt, and then blow the remaining dirt out with compressed air.
5. Check the air filter element for damage and replace it if necessary.
6. Insert the air filter element into the air filter case.
7. Install the air filter case cover by installing the screws.

## Cleaning the V-belt case air filter element

1. Remove the V-belt case air filter cover by removing the screws.

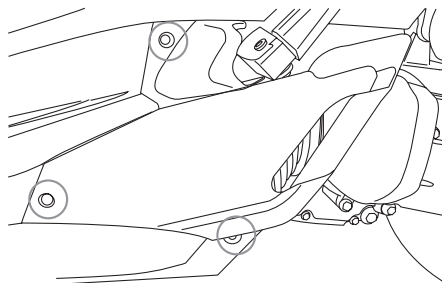
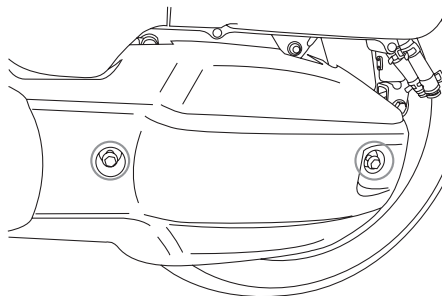

2. Remove the air filter element, and then blow out the dirt with compressed air as shown.

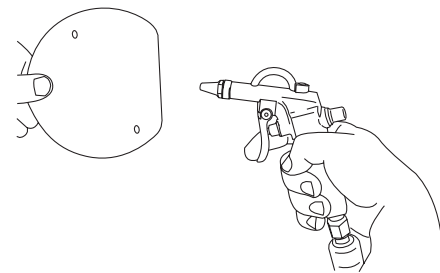
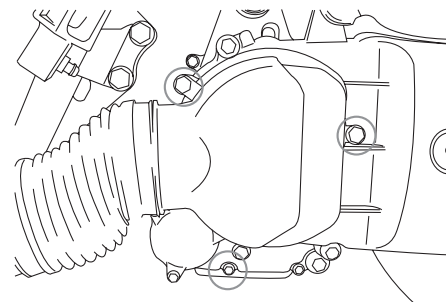

3. Check the air filter element for damage and replace it if necessary.
4. Install the air filter element with the colored side facing outward.
5. Install the V-belt case air filter cover by installing the screws.

# PERIODIC MAINTENANCE AND MINOR REPAIR

ECA10530

## CAUTION:

- Make sure that each filter element is properly seated in its case.
- The engine should never be operated without the filter elements installed, otherwise the piston(s) and/or cylinder(s) may become excessively worn.

EAUS1290

## Adjusting the throttle cable free play

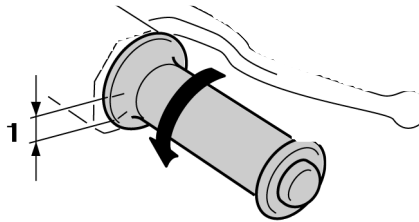

ZAJM0051

### 1. Throttle cable free play

The throttle cable free play should measure 4 ~ 6 mm (0.16 ~ 0.24) at the throttle grip. Periodically check the throttle cable free play and, if necessary, adjust it as follows.

### NOTE:

The engine idling speed must be correctly adjusted before checking and adjusting the throttle cable free play.

1. Remove cowling A (See page 6-6).

### 2. Loosen the locknut.

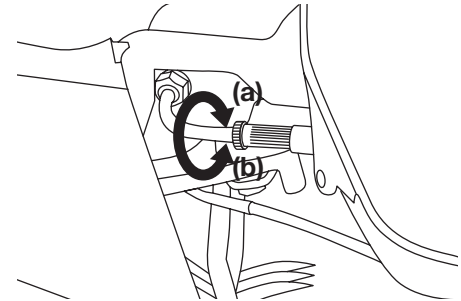

3. To increase the throttle cable free play, turn the adjusting nut in direction (a). To decrease the throttle cable free play, turn the adjusting nut in direction (b).
4. Tighten the locknut.
5. Install the cowling.

# PERIODIC MAINTENANCE AND MINOR REPAIR

## Valve clearance

The valve clearance changes with use, resulting in improper air-fuel mixture and/or engine noise. To prevent this from occurring, the valve clearance must be adjusted by a Yamaha dealer at the intervals specified in the periodic maintenance and lubrication chart.

EAU21401

## Tires

To maximize the performance, durability, and safe operation of your motorcycle, note the following points regarding the specified tires.

EAU21870

### Tire air pressure

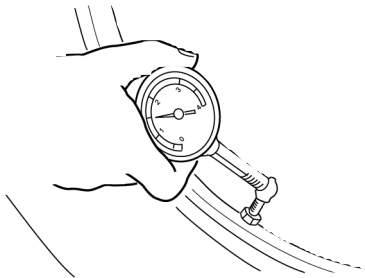

ZALUM0055

The tire air pressure should be checked and, if necessary, adjusted before each ride.

EWA10500

### **WARNING**

- **The tire air pressure must be checked and adjusted on cold tires (i.e., when the temperature of the tires equals the ambient temperature).**
- **The tire air pressure must be adjusted in accordance with the riding speed and with the total weight of rider, passenger, cargo, and accessories approved for this model.**

### **Tire air pressure (measured on cold tires):**

Up to 90 kg (198 lb):

Front:

190 kPa (27 psi) (1.9 kgf/cm<sup>2</sup>)

Rear:

220 kPa (31 psi) (2.2 kgf/cm<sup>2</sup>)

90 kg (198 lb) to maximum load:

Front:

210 kPa (30 psi) (2.1 kgf/cm<sup>2</sup>)

Rear:

250 kPa (36 psi) (2.5 kgf/cm<sup>2</sup>)

### **Maximum load\*:**

189 kg (417 lb)

\* Total weight of rider, passenger, cargo and accessories

EWA10450

### **WARNING**

**Because loading has an enormous impact on the handling, braking, performance and safety characteristics of your vehicle, you should keep the following precautions in mind.**

# PERIODIC MAINTENANCE AND MINOR REPAIR

6

- **NEVER OVERLOAD THE VEHICLE!** Operation of an overloaded vehicle may result in tire damage, loss of control, or severe injury. Make sure that the total weight of rider, cargo, and accessories does not exceed the specified maximum load for the vehicle.
- Do not carry along loosely packed items, which can shift during a ride.
- Securely pack the heaviest items close to the center of the vehicle and distribute the weight evenly on both sides.
- Adjust the suspension and tire air pressure with regard to the load.
- Check the tire condition and air pressure before each ride.

## Tire inspection

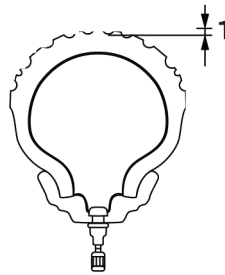

### 1. Tire tread depth

The tires must be checked before each ride. If the center tread depth reaches the specified limit, if the tire has a nail or glass fragments in it, or if the sidewall is cracked, have a Yamaha dealer replace the tire immediately.

**Minimum tire tread depth (front and rear):**  
1.6 mm (0.06 in)

### NOTE:

The tire tread depth limits may differ from country to country. Always comply with the local regulations.

## Tire information

This motorcycle is equipped with tubeless tires.

### Front tire:

Size:

120/70-15 M/C 56P 56S

Manufacturer/model:

Michelin / GoldStandard  
Pirelli / GTS23

### Rear tire:

Size:

140/70-15 M/C 56P 56S

Manufacturer/model:

Michelin / GoldStandard  
Pirelli / GTS24

EWA10470

## **WARNING**

- **Have a Yamaha dealer replace excessively worn tires. Besides being illegal, operating the vehicle with excessively worn tires decreases riding stability and can lead to loss of control.**
- **The replacement of all wheel and brake related parts, including the tires, should be left to a Yamaha dealer, who has the necessary professional knowledge and experience.**

# PERIODIC MAINTENANCE AND MINOR REPAIR

EAU21960

## Cast wheels

To maximize the performance, durability, and safe operation of your motorcycle, note the following points regarding the specified wheels.

- The wheel rims should be checked for cracks, bends or warpage before each ride. If any damage is found, have a Yamaha dealer replace the wheel. Do not attempt even the smallest repair to the wheel. A deformed or cracked wheel must be replaced.
- The wheel should be balanced whenever either the tire or wheel has been changed or replaced. An unbalanced wheel can result in poor performance, adverse handling characteristics, and a shortened tire life.
- Ride at moderate speeds after changing a tire since the tire surface must first be “broken in” for it to develop its optimal characteristics.

EAU33451

## Front and rear brake lever free play

### Front

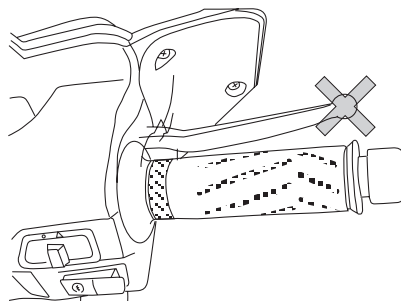

### Rear

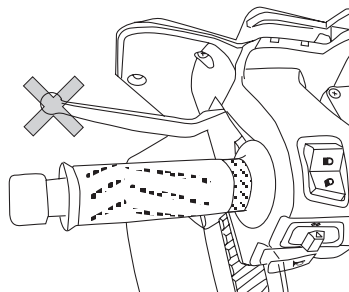

There should be no free play at the brake lever ends. If there is free play, have a Yamaha dealer inspect the brake system.

EAU22390

## Checking the front and rear brake pads

The front and rear brake pads must be checked for wear at the intervals specified in the periodic maintenance and lubrication chart.

EAU22400

### Front brake pads

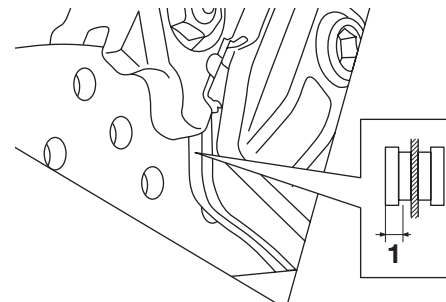

#### 1. Lining thickness

Check each front brake pad for damage and measure the lining thickness. If a brake pad is damaged or if the lining thickness is less than 0.5 mm (0.02 in), have a Yamaha dealer replace the brake pads as a set.

# PERIODIC MAINTENANCE AND MINOR REPAIR

EAU22520

## Rear brake pads

The rear brake is provided with a check plug, which, if it is removed, allows you to check the brake pad wear without disassembling the brake. To check the brake pad wear, check the position of the wear indicator while applying the brake. If a brake pad has worn to the point that the wear indicator almost touches the brake disc, have a Yamaha dealer replace the brake pads as a set.

6

## Checking the brake fluid level

Insufficient brake fluid may allow air to enter the brake system, possibly causing it to become ineffective. Before riding, check that the brake fluid is above the minimum level mark and replenish if necessary. A low brake fluid level may indicate worn brake pads and/or brake system leakage. If the brake fluid level is low, be sure to check the brake pads for wear and the brake system for leakage. Observe these precautions:

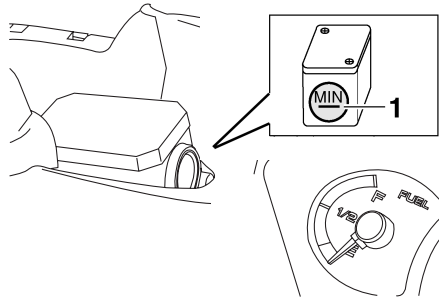

EAU22580

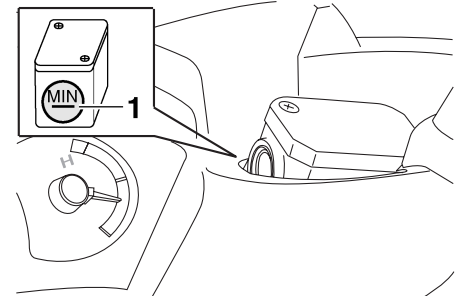

- When checking the fluid level, make sure that the top of the brake fluid reservoir is level.
- Use only the recommended quality brake fluid, otherwise the rubber seals may deteriorate, causing leakage and poor braking performance.

**Recommended brake fluid:**  
DOT 4

- Refill with the same type of brake fluid. Mixing fluids may result in a harmful chemical reaction and lead to poor braking performance.
- Be careful that water does not enter the brake fluid reservoir

# PERIODIC MAINTENANCE AND MINOR REPAIR

when refilling. Water will significantly lower the boiling point of the fluid and may result in vapor lock.

- Brake fluid may deteriorate painted surfaces or plastic parts. Always clean up spilled fluid immediately.
- As the brake pads wear, it is normal for the brake fluid level to gradually go down. However, if the brake fluid level goes down suddenly, have a Yamaha dealer check the cause.

EAUM1360

## Changing the brake fluid

Have a Yamaha dealer change the brake fluid at the intervals specified in the periodic maintenance and lubrication chart. In addition, have the brake hose replaced every four years or whenever it is damaged or leaking.

EAU23111

## Checking and lubricating the throttle grip and cable

The operation of the throttle grip should be checked before each ride. In addition, the cable should be lubricated at the intervals specified in the periodic maintenance chart.

# PERIODIC MAINTENANCE AND MINOR REPAIR

EAU23170

## Lubricating the front and rear brake levers

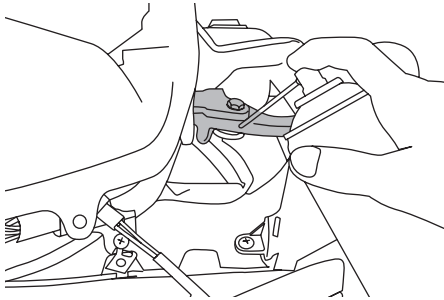

The pivoting points of the front and rear brake levers must be lubricated at the intervals specified in the periodic maintenance and lubrication chart.

### Recommended lubricant:

Lithium-soap-based grease (all-purpose grease)

EAU23211

## Checking and lubricating the centerstand and sidestand

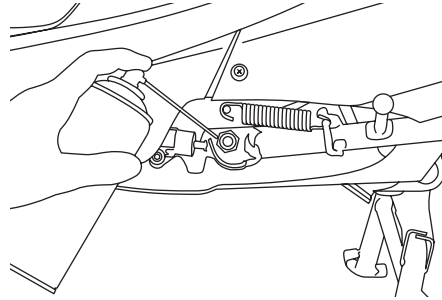

The operation of the centerstand and sidestand should be checked before each ride, and the pivots and metal-to-metal contact surfaces should be lubricated if necessary.

EWA10740

### ⚠ WARNING

If the centerstand or sidestand does not move up and down smoothly, have a Yamaha dealer check or repair it.

### Recommended lubricant:

Lithium-soap-based grease (all-purpose grease)

EAU23271

## Checking the front fork

The condition and operation of the front fork must be checked as follows at the intervals specified in the periodic maintenance and lubrication chart.

### To check the condition

EWA10750

### ⚠ WARNING

Securely support the motorcycle so that there is no danger of it falling over.

Check the inner tubes for scratches, damage and excessive oil leakage.

### To check the operation

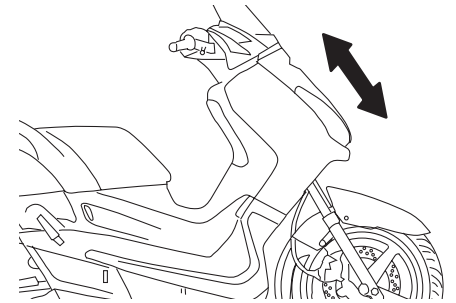

1. Place the motorcycle on a level surface and hold it in an upright position.



# PERIODIC MAINTENANCE AND MINOR REPAIR

2. While applying the front brake, push down hard on the handlebars several times to check if the front fork compresses and rebounds smoothly.

ECA10590

## CAUTION:

If any damage is found or the front fork does not operate smoothly, have a Yamaha dealer check or repair it.

EAU23280

## Checking the steering

Worn or loose steering bearings may cause danger. Therefore, the operation of the steering must be checked as follows at the intervals specified in the periodic maintenance and lubrication chart.

1. Place a stand under the engine to raise the front wheel off the ground.

EWA10750

## ⚠ WARNING

Securely support the motorcycle so that there is no danger of it falling over.

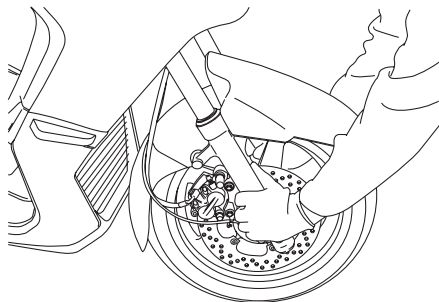

2. Hold the lower ends of the front fork legs and try to move them forward and backward. If any free

play can be felt, have a Yamaha dealer check or repair the steering.

# PERIODIC MAINTENANCE AND MINOR REPAIR

EAU23290

## Checking the wheel bearings

The front and rear wheel bearings must be checked at the intervals specified in the periodic maintenance and lubrication chart. If there is play in the wheel hub or if the wheel does not turn smoothly, have a Yamaha dealer check the wheel bearings.

EAU23380

## Battery

The battery is located behind panel A. (See page 6-6.)

This model is equipped with a sealed-type (MF) battery, which does not require any maintenance. There is no need to check the electrolyte or to add distilled water.

ECA10620

### CAUTION:

**Never attempt to remove the battery cell seals, as this would permanently damage the battery.**

EWA10760

### ⚠ WARNING

- **Electrolyte is poisonous and dangerous since it contains sulfuric acid, which causes severe burns. Avoid any contact with skin, eyes or clothing and always shield your eyes when working near batteries. In case of contact, administer the following FIRST AID.**
  - **EXTERNAL:** Flush with plenty of water.
  - **INTERNAL:** Drink large quantities of water or milk and immediately call a physician.
  - **EYES:** Flush with water for 15 minutes and seek prompt medical attention.
- **Batteries produce explosive hydrogen gas. Therefore, keep sparks, flames, cigarettes, etc., away from the battery and provide sufficient ventilation when charging it in an enclosed space.**
- **KEEP THIS AND ALL BATTERIES OUT OF THE REACH OF CHILDREN.**

## To charge the battery

Have a Yamaha dealer charge the battery as soon as possible if it seems to have discharged. Keep in mind that the battery tends to discharge more quickly if the vehicle is equipped with optional electrical accessories.

## To store the battery

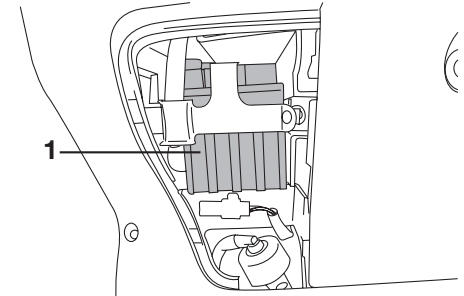

1. Battery

1. If the vehicle will not be used for more than one month, remove the battery, fully charge it, and then place it in a cool, dry place.
2. If the battery will be stored for more than two months, check it at least once a month and fully charge it if necessary.

# PERIODIC MAINTENANCE AND MINOR REPAIR

3. Fully charge the battery before installation.
4. After installation, make sure that the battery leads are properly connected to the battery terminals.

## CAUTION:

- Always keep the battery charged. Storing a discharged battery can cause permanent battery damage.
- To charge a sealed-type (MF) battery, a special (constant-voltage) battery charger is required. Using a conventional battery charger will damage the battery. If you do not have access to a sealed-type (MF) battery charger, have a Yamaha dealer charge your battery.

ECA10630

## Replacing the fuses

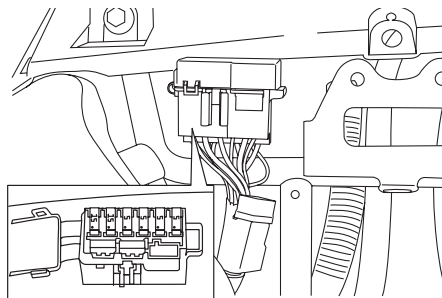

EAU23610

The main fuse and the fuse box, which contains the fuses for the individual circuits, are located behind cowling B. (See page 6-6.)

If a fuse is blown, replace it as follows.

1. Turn the key to “OFF” and turn off the electrical circuit in question.
2. Remove the blown fuse, and then install a new fuse of the specified amperage.

## Specified fuses:

- Main fuse:  
30 A
- Headlight fuse:  
15 A
- Signaling system fuse:  
15 A
- Ignition fuse:  
5 A
- Clock fuse (backup):  
5 A
- Radiator fan fuse:  
10 A

ECA10640

## CAUTION:

**Do not use a fuse of a higher amperage rating than recommended to avoid causing extensive damage to the electrical system and possibly a fire.**

3. Turn the key to “ON” and turn on the electrical circuit in question to check if the device operates.
4. If the fuse immediately blows again, have a Yamaha dealer check the electrical system.

# PERIODIC MAINTENANCE AND MINOR REPAIR

EAU23910

## Replacing a headlight bulb

This model is equipped with quartz bulb headlights. If a headlight bulb burns out, replace it as follows.

1. Remove cowling B. (See page 6-6.)

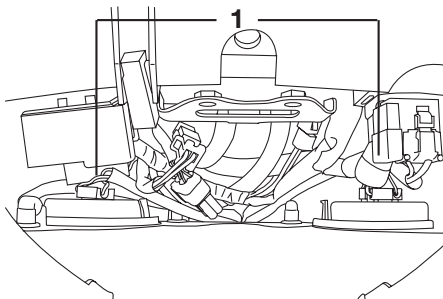

1. Headlight coupler

2. Disconnect the headlight coupler, and then remove the headlight bulb cover.
3. Remove the headlight bulb holder according to the following illustration, and then remove the defective bulb.

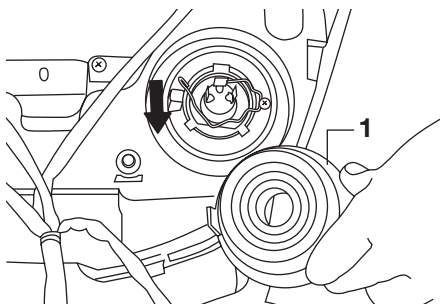

1. Headlight bulb cover

### NOTE:

The removal procedure depends on the type of bulb holder installed on your vehicle.

EWA10790

### **⚠ WARNING**

**Headlight bulbs get very hot. Therefore, keep flammable products away from a lit headlight bulb, and do not touch the bulb until it has cooled down.**

4. Place a new bulb into position, and then secure it with the bulb holder.

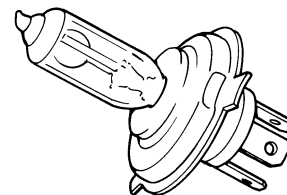

ECA10660

### CAUTION:

**Do not touch the glass part of the headlight bulb to keep it free from oil, otherwise the transparency of the glass, the luminosity of the bulb, and the bulb life will be adversely affected. Thoroughly clean off any dirt and fingerprints on the headlight bulb using a cloth moistened with alcohol or thinner.**

5. Install the bulb cover, and then connect the coupler.
6. Install the cowling.
7. Have a Yamaha dealer adjust the headlight beam if necessary.

# PERIODIC MAINTENANCE AND MINOR REPAIR

## Replacing a front turn signal light bulb

EAUT1260

ECA10670

### CAUTION:

It is advisable to have a Yamaha dealer perform this job.

1. Place the scooter on the centerstand.
2. Remove cowling A. (See page 6-6.)
3. Remove the socket (together with the bulb) by turning it counterclockwise.

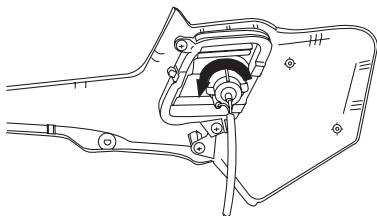

4. Remove the defective bulb by pushing it in and turning it counterclockwise.

5. Insert a new bulb into the socket, push it in, and then turn it clockwise until it stops.
6. Install the socket (together with the bulb) by turning it clockwise.
7. Install the cowling.

## Replacing the tail/brake light bulb or a rear turn signal light bulb

EAUS1250

### Tail/brake light bulb

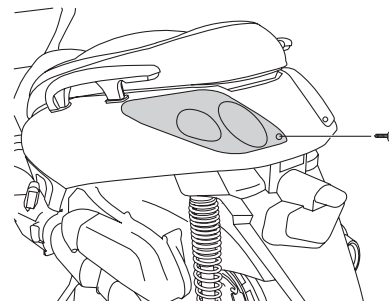

1. Remove the tail/brake light bulb lens by removing the screws.
2. Remove the defective bulb by pushing it in and turning it counterclockwise.
3. Insert a new bulb into the socket, push it in, and then turn it clockwise until it stops.
4. Install the lens by installing the screws.

# PERIODIC MAINTENANCE AND MINOR REPAIR

## Rear turn signal light bulb

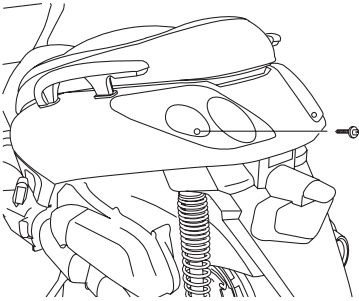

1. Remove the tail/brake light lens by removing the screw.
2. Remove the turn signal light bulb lens by removing the screw.
3. Remove the defective bulb by pushing it in and turning it counterclockwise.
4. Insert a new bulb into the socket, push it in, and then turn it clockwise until it stops.
5. Install the turn signal light bulb lens by installing the screw.

6. Install the tail/brake light bulb lens by installing the screw.

ECA10680

### **CAUTION:**

**Do not overtighten the screws, otherwise the lens may break.**

EAUS1150

## Replacing the license plate light bulb

1. Remove the lens by removing the screw.

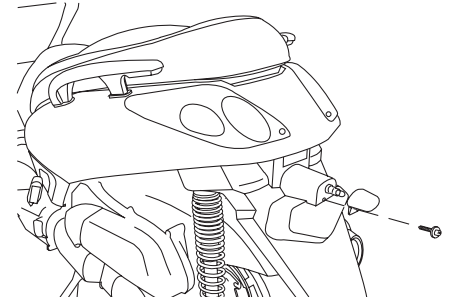

2. Remove the defective bulb by pulling it out.
3. Insert a new bulb into the socket.
4. Install the lens by installing the screw.

# PERIODIC MAINTENANCE AND MINOR REPAIR

ECA11190

EAUS1260

EAU25880

## CAUTION:

**Do not overtighten the screw, otherwise the lens may break.**

## Replacing the auxiliary light bulb

If the auxiliary light bulb burns out, replace it as follows.

1. Remove cowling B . (See page 6-6.).

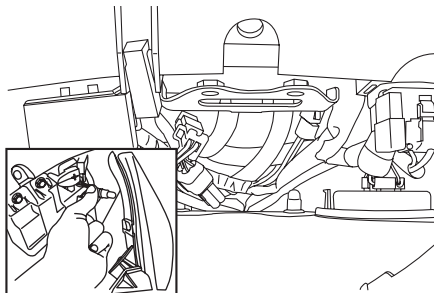

2. Remove the socket (together with the bulb) by pulling it out.
3. Remove the defective bulb by pulling it out.
4. Insert a new bulb into the socket.
5. Install the socket (together with the bulb) by pushing it in.
6. Install the cowling B.

## Troubleshooting

Although Yamaha scooters receive a thorough inspection before shipment from the factory, trouble may occur during operation. Any problem in the fuel, compression, or ignition systems, for example, can cause poor starting and loss of power.

The following troubleshooting charts represent quick and easy procedures for checking these vital systems yourself. However, should your scooter require any repair, take it to a Yamaha dealer, whose skilled technicians have the necessary tools, experience, and know-how to service the scooter properly.

Use only genuine Yamaha replacement parts. Imitation parts may look like Yamaha parts, but they are often inferior, have a shorter service life and can lead to expensive repair bills.

# PERIODIC MAINTENANCE AND MINOR REPAIR

EAU25921

## Troubleshooting charts

### Starting problems or poor engine performance

EWA10840

#### **⚠ WARNING**

**Keep away open flames and do not smoke while checking or working on the fuel system.**

#### 1. Fuel

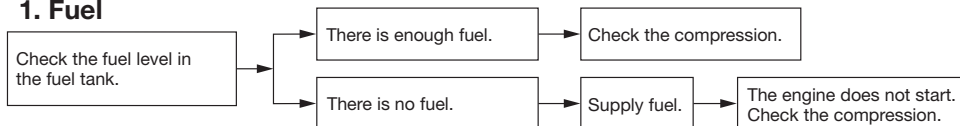

#### 2. Compression

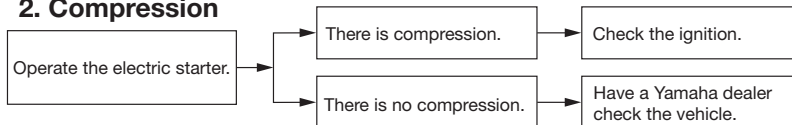

#### 3. Ignition

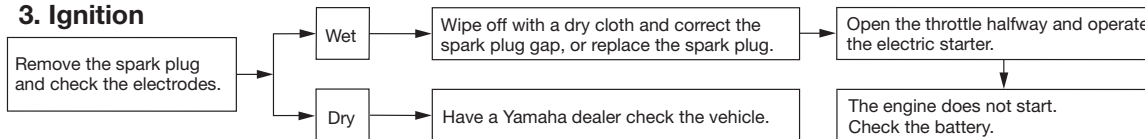

#### 4. Battery

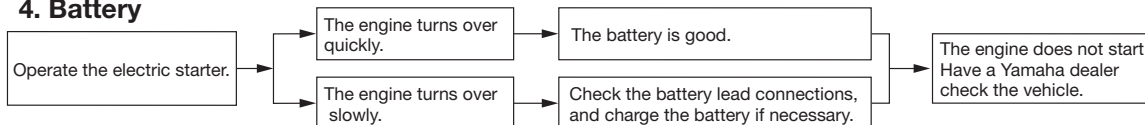



# PERIODIC MAINTENANCE AND MINOR REPAIR

## Engine overheating

EWA10400

### **⚠ WARNING**

- Do not remove the radiator cap when the engine and radiator are hot. Scalding hot fluid and steam may be blown out under pressure, which could cause serious injury. Be sure to wait until the engine has cooled.
- After removing the radiator cap retaining bolt, place a thick rag, like a towel, over the radiator cap, and then slowly rotate the cap counterclockwise to the detent to allow any residual pressure to escape. When the hissing sound has stopped, press down on the cap while turning it counterclockwise, and then remove the cap.

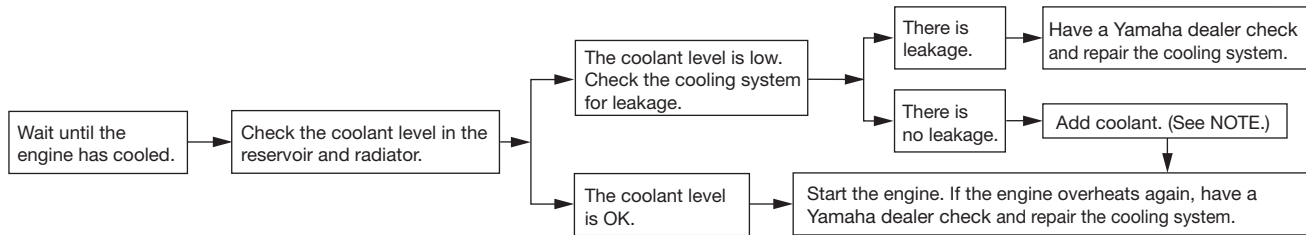

### **NOTE:**

If coolant is not available, tap water can be temporarily used instead, provided that it is changed to the recommended coolant as soon as possible.

# SCOOTER CARE AND STORAGE

---

EAU26090

## Care

While the open design of a scooter reveals the attractiveness of the technology, it also makes it more vulnerable. Rust and corrosion can develop even if high-quality components are used. A rusty exhaust pipe may go unnoticed on a car, however, it detracts from the overall appearance of a scooter. Frequent and proper care does not only comply with the terms of the warranty, but it will also keep your scooter looking good, extend its life and optimize its performance.

### Before cleaning

1. Cover the muffler outlet with a plastic bag after the engine has cooled down.
2. Make sure that all caps and covers as well as all electrical couplers and connectors, including the spark plug cap, are tightly installed.
3. Remove extremely stubborn dirt, like oil burnt onto the crankcase, with a degreasing agent and a brush, but never apply such pro-

ducts onto seals, gaskets and wheel axles. Always rinse the dirt and degreaser off with water.

### Cleaning

ECA10780

#### CAUTION:

- **Avoid using strong acidic wheel cleaners, especially on spoked wheels. If such products are used on hard-to-remove dirt, do not leave the cleaner on the affected area any longer than instructed. Also, thoroughly rinse the area off with water, immediately dry it, and then apply a corrosion protection spray.**
- **Improper cleaning can damage windshields, cowlings, panels and other plastic parts. Use only a soft, clean cloth or sponge with mild detergent and water to clean plastic.**
- **Do not use any harsh chemical products on plastic parts. Be sure to avoid using cloths or sponges which have been in contact with strong or abrasive cleaning products, solvent or**

thinner, fuel (gasoline), rust removers or inhibitors, brake fluid, antifreeze or electrolyte.

- **Do not use high-pressure washers or steam-jet cleaners since they cause water seepage and deterioration in the following areas: seals (of wheel and swingarm bearings, fork and brakes), electric components (couplers, connectors, instruments, switches and lights), breather hoses and vents.**
  - **For scooters equipped with a windshield: Do not use strong cleaners or hard sponges as they will cause dulling or scratching. Some cleaning compounds for plastic may leave scratches on the windshield. Test the product on a small hidden part of the windshield to make sure that it does not leave any marks. If the windshield is scratched, use a quality plastic polishing compound after washing.**
-

# SCOOTER CARE AND STORAGE

## After normal use

Remove dirt with warm water, a mild detergent, and a soft, clean sponge, and then rinse thoroughly with clean water. Use a toothbrush or bottle-brush for hard-to-reach areas. Stubborn dirt and insects will come off more easily if the area is covered with a wet cloth for a few minutes before cleaning.

## After riding in the rain, near the sea or on salt-sprayed roads

Since sea salt or salt sprayed on the roads during winter are extremely corrosive in combination with water, carry out the following steps after each ride in the rain, near the sea or on salt-sprayed roads.

## **NOTE:** \_\_\_\_\_

Salt sprayed on roads in the winter may remain well into spring.

1. Clean the scooter with cold water and a mild detergent after the engine has cooled down.

ECA10790

## **CAUTION:** \_\_\_\_\_

**Do not use warm water since it increases the corrosive action of the salt.**

2. Apply a corrosion protection spray on all metal, including chrome- and nickel-plated, surfaces to prevent corrosion.

## **After cleaning**

1. Dry the scooter with a chamois or an absorbing cloth.
2. Use a chrome polish to shine chrome, aluminum and stainless-steel parts, including the exhaust system. (Even the thermally induced discoloring of stainless-steel exhaust systems can be removed through polishing.)
3. To prevent corrosion, it is recommended to apply a corrosion protection spray on all metal, including chrome- and nickel-plated, surfaces.
4. Use spray oil as a universal cleaner to remove any remaining dirt.
5. Touch up minor paint damage caused by stones, etc.

6. Wax all painted surfaces.
7. Let the scooter dry completely before storing or covering it.

EWA10940

## **⚠ WARNING** \_\_\_\_\_

- **Make sure that there is no oil or wax on the brakes or tires. If necessary, clean the brake discs and brake linings with a regular brake disc cleaner or acetone, and wash the tires with warm water and a mild detergent.**
- **Before operating the scooter test its braking performance and cornering behavior.**

ECA10800

## **CAUTION:** \_\_\_\_\_

- **Apply spray oil and wax sparingly and make sure to wipe off any excess.**
- **Never apply oil or wax to any rubber and plastic parts, but treat them with a suitable care product.**
- **Avoid using abrasive polishing compounds as they will wear away the paint.**

# SCOOTER CARE AND STORAGE

---

**NOTE:** \_\_\_\_\_  
Consult a Yamaha dealer for advice  
on what products to use.  
\_\_\_\_\_

EAU26300

## Storage Short-term

Always store your scooter in a cool, dry place and, if necessary, protect it against dust with a porous cover.

ECA10820

## CAUTION:

- **Storing the scooter in a poorly ventilated room or covering it with a tarp, while it is still wet, will allow water and humidity to seep in and cause rust.**
- **To prevent corrosion, avoid damp cellars, stables (because of the presence of ammonia) and areas where strong chemicals are stored.**

---

## Long-term

Before storing your scooter for several months:

1. Follow all the instructions in the “Care” section of this chapter.
2. Drain the carburetor float chamber by loosening the drain bolt; this will prevent fuel deposits from building up. Pour the drained fuel into the fuel tank.

3. Fill up the fuel tank and add fuel stabilizer (if available) to prevent the fuel tank from rusting and the fuel from deteriorating.
4. Perform the following steps to protect the cylinder, piston rings, etc. from corrosion.
  - a. Remove the spark plug cap and spark plug.
  - b. Pour a teaspoonful of engine oil into the spark plug bore.
  - c. Install the spark plug cap onto the spark plug, and then place the spark plug on the cylinder head so that the electrodes are grounded. (This will limit sparking during the next step.)
  - d. Turn the engine over several times with the starter. (This will coat the cylinder wall with oil.)
  - e. Remove the spark plug cap from the spark plug, and then install the spark plug and the spark plug cap.

EWA10950

## **WARNING**

**To prevent damage or injury from sparking, make sure to ground the spark plug electrodes while turning the engine over.**

5. Lubricate all control cables and the pivoting points of all levers and pedals as well as of the sidestand/centerstand.
6. Check and, if necessary, correct the tire air pressure, and then lift the scooter so that both of its wheels are off the ground. Alternatively, turn the wheels a little every month in order to prevent the tires from becoming degraded in one spot.
7. Cover the muffler outlet with a plastic bag to prevent moisture from entering it.
8. Remove the battery and fully charge it. Store it in a cool, dry place and charge it once a month. Do not store the battery in an excessively cold or warm place [less than 0 °C (30 °F) or more than 30 °C (90 °F)]. For more

information on storing the battery, see page 6-22.

**NOTE:** \_\_\_\_\_  
Make any necessary repairs before storing the scooter.

# SPECIFICATIONS

## Dimensions

Overall length  
2210 mm (87.0 in)  
Overall width  
790 mm (31.1 in)  
Overall height  
1380 mm (54.3 in)  
Seat height  
785 mm (30.9 in)  
Wheelbase  
1545 mm (60.8 in)  
Ground clearance  
113 mm (4.45 in)  
Minimum turning radius  
3650 mm (143.7 in)

## Weight

With oil and fuel  
166 kg (366 lb)

## Engine

Engine type  
Liquid cooled 4-stroke, SOHC  
Cylinder arrangement  
Forward-inclined single cylinder  
Displacement  
124.66 cm<sup>3</sup> (7.61 cu\*in)  
Bore x stroke  
52 x 58.6 mm (2.05 x 2.31 in)  
Compression ratio  
11.2:1  
Starting system  
Electric starter  
Lubrication system  
Wet sump

## Oil type or grade

Engine oil  
SAE 10W30  
Recommended engine oil grade  
API service SG type or higher

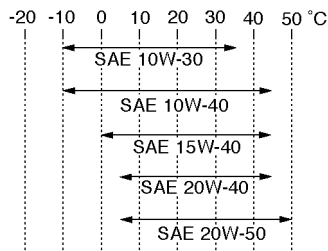

## Engine oil quantity

Without oil filter element replacement  
1.4 L (1.48 US qt) (1.23 Imp qt)  
With oil filter element replacement  
1.5L (1.59 US qt) (1.32 Imp qt)

## Final transmission oil

Type  
YAMALUBE 4 (10W30) of SAE10W30 type SE motorolie  
Quantity  
0.21 L (0.22 US qt) (0.18 Imp qt)

## Cooling system

Coolant reservoir capacity (up to the maximum level mark)  
0.26 L (0.28 US qt) (0.23 Imp qt)

## Air filter

Air filter element  
Dry element

## Recommended fuel

Recommended fuel  
Unleaded fuel  
Fuel tank capacity  
12.5 L (13.21 US qt) (11.00 Imp qt)  
Fuel reserve amount  
2 L (2.11 US qt) (1.76 Imp qt)

## Fuel injection

Manufacturer  
AISAN  
Type x quantity  
EFI System x 1

## Spark plug (s)

Manufacturer/model  
NGK / CPR 9EA-9  
Spark plug gap  
0.8-0.9 mm (0.031-0.035 in)

## Clutch

Clutch type  
Dry, automatic centrifugal

## Transmission

Primary reduction system  
Helical gear  
Primary reduction ratio  
41/14 (2.929)  
Secondary reduction system  
Helical gear  
Secondary reduction ratio  
44/13 (3.385)  
Transmission type  
V-belt automatic

Operation  
Centrifugal automatic type

## Chassis

Frame type  
Steel tube underbone  
Caster angle  
28 °  
Trail  
100 mm (3.94 in)

## Front tire

Type  
Tubeless  
Size  
120/70-15 M/C 56P or 56S  
Manufacturer/model  
Michelin / Gold Standard  
Pirelli / GTS23

## Rear tire

Type  
Tubeless  
Size  
140/70-14 M/C 68P or 68S  
Manufacturer/model  
Michelin / Gold Standard  
Pirelli / GTS24

## Loading

Maximum load  
189 kg (417 lb)  
Load is total weight of the equipment, driver, passenger and accessories

## Tire air pressure (measured on cold tires)

Loading condition  
0–90 kg (0–198 lb)

Front  
190 kPa (27 psi) (1.9 kgf/cm<sup>2</sup>)  
Rear  
220 kPa (31 psi) (2.2 kgf/cm<sup>2</sup>)  
Loading condition  
90 kg (198 lb)–Maximum load  
Front  
210 kPa (30 psi) (2.1 kgf/cm<sup>2</sup>)  
Rear  
250 kPa (36 psi) (2.5 kgf/cm<sup>2</sup>)

## Front wheel

Wheel type  
Aluminium wheel  
Rim size  
15 x MT3.5

## Rear wheel

Wheel type  
Aluminium wheel  
Rim size  
14 x MT3.75

## Front brake

Type  
Single disc brake  
Operation  
Right hand operation  
Recommended fluid  
DOT 4

## Rear brake

Type  
Single disc brake  
Operation  
Left hand operation  
Recommended fluid  
DOT 4

## Front suspension

Type  
Telescopic fork  
Spring/shock absorber type  
Coil spring/oil damper  
Wheel travel  
94 mm (3.70 in)

## Rear suspension

Type  
Unit swing  
Spring/shock absorber type  
Coil spring/oil damper  
Wheel travel  
83 mm (3.27 in)

## Electrical system

Ignition system  
Transistorized coil ignition (digital)  
Charging system  
AC magneto

## Battery

Manufacturer/model  
GS/GTX9 BS  
Voltage, capacity  
12 V, 8.0 Ah

## Bulb voltage, wattage x quantity

Headlight  
12 V, 35.0 W / 35.0 W x 2  
Auxiliary light  
12 V, 5.0 W x 2  
Tail/brake light  
12 V, 21.0 W / 5.0 W x 2  
Front turn signal light  
12 V, 10.0 W x 2

# SPECIFICATIONS

---

Rear turn signal light

12 V, 10.0 W x 2

License plate light

12 V, 5.0 W x 1

Meter lighting

LED

Fuel level warning lamp

LED

High beam Indicator light

LED

Turn signal indicator light

LED x 2

Engine trouble warning light

LED

Immobilizer light

LED

Reserve fuse

15 A

Reserve fuse

30 A

## Fuses

Main fuse

30 A

Headlight fuse

15 A

Signaling system fuse

15 A

Ignition fuse

5 A

Radiator fan fuse

10 A

ECU fuse

5 A

Backup fuse

5 A

Reserve fuse

5 A

Reserve fuse

10 A



EAU26351

EAU26381

EAU26410

## Identification numbers

Record the key identification number, vehicle identification number and model label information in the spaces provided below for assistance when ordering spare parts from a Yamaha dealer or for reference in case the vehicle is stolen.

KEY IDENTIFICATION NUMBER:

VEHICLE IDENTIFICATION NUMBER:

MODEL LABEL INFORMATION:

## Key identification number

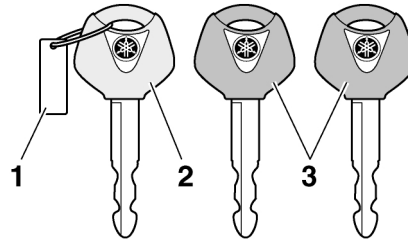

1. Key tag
2. Master key
3. Keys

The key identification number is stamped into the key tag. Record this number in the space provided and use it for reference when ordering a new key.

## Vehicle identification number

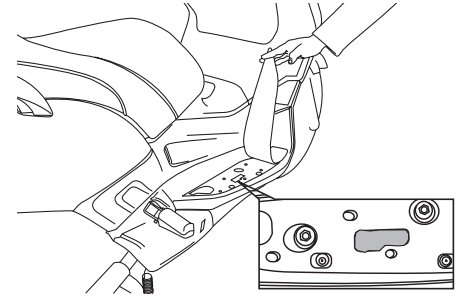

The vehicle identification number is stamped into the frame.

**NOTE:** \_\_\_\_\_  
The vehicle identification number is used to identify your motorcycle and may be used to register your motorcycle with the licensing authority in your area.

# CONSUMER INFORMATION

---

EAU26540

## Model label

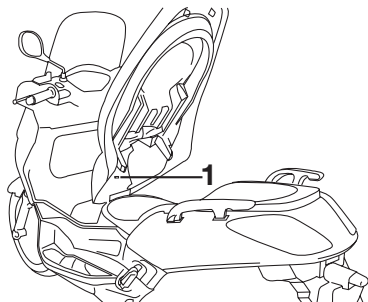

1- Model label

The model label is affixed to the bottom of the seat. (See page 3-11.) Record the information on this label in the space provided. This information will be needed when ordering spare parts from a Yamaha dealer.

<b>A</b>		
Acceleration and deceleration .....	5-2	
Adjusting the shock absorber assemblies .....	3-13	
Adjusting the throttle cable free play .....	6-14	
Air filter and V-belt case air filter elements .....	6-12	
Anti-theft alarm (optional) .....	3-7	
<b>B</b>		
Battery .....	6-22	
Braking .....	5-2	
<b>C</b>		
Care .....	7-1	
Cast wheels .....	6-17	
Catalytic converter .....	3-11	
Changing the brake fluid .....	6-19	
Checking and lubricating the centerstand and sidestand .....	6-20	
Checking and lubricating the throttle grip and cable .....	6-19	
Checking the brake fluid level .....	6-18	
Checking the front and rear brake pads ..	6-17	
Checking the front fork .....	6-20	
Checking the spark plug .....	6-7	
Checking the steering .....	6-21	
Checking the wheel bearings .....	6-22	
Controls and instruments .....	2-3	
Coolant .....	6-11	
Coolant temperature gauge .....	3-4	
<b>E</b>		
Engine break-in .....	5-3	
Engine oil .....	6-8	
<b>F</b>		
Final transmission oil .....	6-10	
		Front and rear brake lever free play .....
		6-17
		Front brake lever .....
		3-9
		Front storage compartment .....
		3-12
		Fuel .....
		3-10
		Fuel gauge .....
		3-4
		Fuel tank cap .....
		3-10
<b>H</b>		
Handlebar switches .....	3-8	
<b>I</b>		
Identification numbers .....	9-1	
Immobilizer system .....	3-1	
Indicators, indicator lights and warning light .....	3-3	
<b>L</b>		
Left view .....	2-1	
Lubricating the front and rear brake levers .....	6-20	
<b>M</b>		
Main switch/steering lock .....	3-2	
Multi-function display .....	3-5	
<b>O</b>		
Owner's tool kit .....	6-1	
<b>P</b>		
Parking .....	5-4	
Periodic maintenance and lubrication chart .....	6-3	
Pre-operation check list .....	4-2	
<b>R</b>		
Rear brake lever .....	3-9	
Removing and installing cowlings and panels .....	6-6	
Replacing a front turn signal light bulb ..	6-25	
Replacing a headlight bulb .....	6-24	
Replacing the auxiliary light bulb .....	6-27	
		Replacing the fuses .....
		6-23
		Replacing the license plate light bulb .....
		6-26
		Replacing the tail/brake light bulb or a rear turn signal light bulb .....
		6-25
		Right view .....
		2-2
<b>S</b>		
Seat .....	3-11	
Sidestand .....	3-13	
Speedometer .....	3-4	
Starting a cold engine .....	5-1	
Starting off .....	5-2	
Storage .....	7-3	
Storage compartment .....	3-12	
<b>T</b>		
Tips for reducing fuel consumption .....	5-3	
Tires .....	6-15	
Troubleshooting .....	6-27	
Troubleshooting charts .....	6-28	
<b>V</b>		
Valve clearance .....	6-15	



PRINTED IN SPAIN  
2006.10-NOVOPRINT, S.A.  
(E)