



⚠ Read this manual carefully before operating this vehicle.

OWNER'S MANUAL

**XJ6**

**XJ6N**  
**XJ6NA**

20S-28199-E2

 **Read this manual carefully before operating this vehicle. This manual should stay with this vehicle if it is sold.**



YAMAHA MOTOR ELECTRONICS CO., LTD.  
1450-6, Mori, Mori-machi, Shuchi-gun, Shizuoka-ken, 437-0292 Japan

## DECLARATION of CONFORMITY

We

Company: YAMAHA MOTOR ELECTRONICS CO., LTD.

Address: 1450-6, Mori, Mori-Machi, Shuchi-gun, Shizuoka-Ken, 437-0292 Japan

Hereby declare that the product:

Kind of equipment: IMMOBILIZER

Type-designation: SSL-00

is in compliance with following norm(s) or documents:

R&TTE Directive(1999/5/EC)

EN300 330-2 v1.3.1(2006-01), EN300 330-2 v1.5.1(2010-02)

EN60950-1:2006/A11:2009

Two or Three-Wheel Motor Vehicles Directive(97/24/EC: Chapter 8, EMC)

Place of issue: Shizuoka, Japan

Date of issue: 1 Aug. 2002

### Revision record

No.	Contents	Date
1	To change contact person and integrate type-designation.	9 Jun. 2005
2	Version up the norm of EN60950 to EN60950-1	27 Feb. 2006
3	To change company name	1 Mar. 2007
4	version up of the following norm: • EN300 330-2 v1.1.1 to EN300 330-2 v1.3.1 and EN300 330-2 v1.5.1 • EN60950-1:2001 to EN60950-1:2006/A11:2009	8 Jul. 2010

General manager of quality assurance div.

July 8th 2010



Welcome to the Yamaha world of motorcycling!

As the owner of the XJ6N/XJ6NA, you are benefiting from Yamaha's vast experience and newest technology regarding the design and manufacture of high-quality products, which have earned Yamaha a reputation for dependability.

Please take the time to read this manual thoroughly, so as to enjoy all advantages of your XJ6N/XJ6NA. The Owner's Manual does not only instruct you in how to operate, inspect and maintain your motorcycle, but also in how to safeguard yourself and others from trouble and injury.

In addition, the many tips given in this manual will help keep your motorcycle in the best possible condition. If you have any further questions, do not hesitate to contact your Yamaha dealer.

The Yamaha team wishes you many safe and pleasant rides. So, remember to put safety first!

Yamaha continually seeks advancements in product design and quality. Therefore, while this manual contains the most current product information available at the time of printing, there may be minor discrepancies between your motorcycle and this manual. If there is any question concerning this manual, please consult a Yamaha dealer.



---

**Please read this manual carefully and completely before operating this motorcycle.**

---



# IMPORTANT MANUAL INFORMATION

---

---

EAU10132

Particularly important information is distinguished in this manual by the following notations:

	<b>This is the safety alert symbol. It is used to alert you to potential personal injury hazards. Obey all safety messages that follow this symbol to avoid possible injury or death.</b>
 <b>WARNING</b>	<b>A WARNING indicates a hazardous situation which, if not avoided, could result in death or serious injury.</b>
<b>NOTICE</b>	<b>A NOTICE indicates special precautions that must be taken to avoid damage to the vehicle or other property.</b>
<b>TIP</b>	<b>A TIP provides key information to make procedures easier or clearer.</b>

# **IMPORTANT MANUAL INFORMATION**

---

---

EAU10200

**XJ6N/XJ6NA  
OWNER'S MANUAL  
©2010 by Yamaha Motor Co., Ltd.  
1st edition, June 2010  
All rights reserved.  
Any reprinting or unauthorized use  
without the written permission of  
Yamaha Motor Co., Ltd.  
is expressly prohibited.  
Printed in Japan.**

# TABLE OF CONTENTS

---

<b>SAFETY INFORMATION</b> .....	1-1	Adjusting the shock absorber assembly .....	3-20	Adjusting the engine idling speed .....	6-18
<b>DESCRIPTION</b> .....	2-1	Sidestand .....	3-21	Checking the throttle grip free play .....	6-19
Left view .....	2-1	Ignition circuit cut-off system .....	3-22	Valve clearance .....	6-19
Right view .....	2-2			Tires .....	6-19
Controls and instruments.....	2-3			Cast wheels .....	6-22
				Adjusting the clutch lever free play .....	6-22
<b>INSTRUMENT AND CONTROL FUNCTIONS</b> .....	3-1	<b>FOR YOUR SAFETY – PRE-OPERATION CHECKS</b> .....	4-1	Checking the brake lever free play .....	6-23
Immobilizer system .....	3-1	<b>OPERATION AND IMPORTANT RIDING POINTS</b> .....	5-1	Brake light switches (for ABS models) .....	6-24
Main switch/steering lock .....	3-2	Starting the engine .....	5-1	Brake light switches (for non-ABS models) .....	6-24
Indicator lights and warning lights .....	3-4	Shifting .....	5-2	Checking the front and rear brake pads .....	6-24
Multi-function meter unit .....	3-8	Tips for reducing fuel consumption .....	5-3	Checking the brake fluid level .....	6-25
Anti-theft alarm (optional) .....	3-11	Engine break-in .....	5-3	Changing the brake fluid .....	6-26
Handlebar switches .....	3-12	Parking .....	5-4	Drive chain slack .....	6-26
Clutch lever .....	3-13			Cleaning and lubricating the drive chain .....	6-28
Shift pedal .....	3-13	<b>PERIODIC MAINTENANCE AND ADJUSTMENT</b> .....	6-1	Checking and lubricating the cables .....	6-28
Brake lever .....	3-14	Owner's tool kit .....	6-2	Checking and lubricating the throttle grip and cable .....	6-29
Brake pedal .....	3-14	Periodic maintenance chart for the emission control system .....	6-3	Checking and lubricating the brake and shift pedals .....	6-29
ABS (for ABS models) .....	3-14	General maintenance and lubrication chart .....	6-4	Checking and lubricating the brake and clutch levers .....	6-30
Fuel tank cap .....	3-15	Removing and installing the cowling and panels .....	6-8		
Fuel .....	3-16	Checking the spark plugs .....	6-9		
Fuel tank breather/overflow hose .....	3-17	Engine oil and oil filter cartridge ...	6-10		
Catalytic converter .....	3-17	Coolant .....	6-13		
Seat .....	3-18	Replacing the air filter element .....	6-17		
Helmet holder .....	3-19				
Storage compartment .....	3-19				
Handlebar position .....	3-20				

# TABLE OF CONTENTS

Checking and lubricating the sidestand .....	6-30
Lubricating the swingarm pivots .....	6-31
Checking the front fork .....	6-31
Checking the steering .....	6-32
Checking the wheel bearings .....	6-32
Battery .....	6-32
Replacing the fuses .....	6-34
Replacing the headlight bulb .....	6-36
Replacing the tail/brake light bulb .....	6-38
Replacing a turn signal light bulb .....	6-39
Replacing the license plate light bulb .....	6-39
Replacing the auxiliary light bulb .....	6-40
Supporting the motorcycle .....	6-40
Front wheel (for non-ABS models) .....	6-41
Rear wheel (for non-ABS models) .....	6-42
Troubleshooting .....	6-44
Troubleshooting charts .....	6-45

<b>SPECIFICATIONS</b> .....	8-1
-----------------------------	-----

<b>CONSUMER INFORMATION</b> .....	9-1
Identification numbers .....	9-1

## **MOTORCYCLE CARE AND**

<b>STORAGE</b> .....	7-1
Matte color caution .....	7-1
Care .....	7-1
Storage .....	7-3

EAU10287

1

## Be a Responsible Owner

As the vehicle's owner, you are responsible for the safe and proper operation of your motorcycle.

Motorcycles are single-track vehicles. Their safe use and operation are dependent upon the use of proper riding techniques as well as the expertise of the operator. Every operator should know the following requirements before riding this motorcycle.

He or she should:

- Obtain thorough instructions from a competent source on all aspects of motorcycle operation.
- Observe the warnings and maintenance requirements in this Owner's Manual.
- Obtain qualified training in safe and proper riding techniques.
- Obtain professional technical service as indicated in this Owner's Manual and/or when made necessary by mechanical conditions.

## Safe Riding

Perform the pre-operation checks each time you use the vehicle to make sure it is in safe operating condition. Failure to inspect or maintain the vehicle properly increases the possibility of an accident or equipment damage. See page 4-1 for a list of pre-operation checks.

- This motorcycle is designed to carry the operator and a passenger.
- The failure of motorists to detect and recognize motorcycles in traffic is the predominating cause of automobile/motorcycle accidents. Many accidents have been caused by an automobile driver who did not see the motorcycle. Making yourself conspicuous appears to be very effective in reducing the chance of this type of accident.

### Therefore:

- Wear a brightly colored jacket.
- Use extra caution when you are approaching and passing through intersections, since intersections are the most likely places for motorcycle accidents to occur.

- Ride where other motorists can see you. Avoid riding in another motorist's blind spot.
- Many accidents involve inexperienced operators. In fact, many operators who have been involved in accidents do not even have a current motorcycle license.
- Make sure that you are qualified and that you only lend your motorcycle to other qualified operators.
- Know your skills and limits. Staying within your limits may help you to avoid an accident.
- We recommend that you practice riding your motorcycle where there is no traffic until you have become thoroughly familiar with the motorcycle and all of its controls.
- Many accidents have been caused by error of the motorcycle operator. A typical error made by the operator is veering wide on a turn





due to excessive speed or under-cornering (insufficient lean angle for the speed).

- Always obey the speed limit and never travel faster than warranted by road and traffic conditions.
- Always signal before turning or changing lanes. Make sure that other motorists can see you.
- The posture of the operator and passenger is important for proper control.
  - The operator should keep both hands on the handlebar and both feet on the operator footrests during operation to maintain control of the motorcycle.
  - The passenger should always hold onto the operator, the seat strap or grab bar, if equipped, with both hands and keep both feet on the passenger footrests. Never carry a passenger unless he or she can firmly place both feet on the passenger footrests.
- Never ride under the influence of alcohol or other drugs.

- This motorcycle is designed for on-road use only. It is not suitable for off-road use.

## Protective Apparel

The majority of fatalities from motorcycle accidents are the result of head injuries. The use of a safety helmet is the single most critical factor in the prevention or reduction of head injuries.

- Always wear an approved helmet.
- Wear a face shield or goggles. Wind in your unprotected eyes could contribute to an impairment of vision that could delay seeing a hazard.
- The use of a jacket, heavy boots, trousers, gloves, etc., is effective in preventing or reducing abrasions or lacerations.
- Never wear loose-fitting clothes, otherwise they could catch on the control levers, footrests, or wheels and cause injury or an accident.
- Always wear protective clothing that covers your legs, ankles, and feet. The engine or exhaust system become very hot during or after operation and can cause burns.

- A passenger should also observe the above precautions.

## Avoid Carbon Monoxide Poisoning

All engine exhaust contains carbon monoxide, a deadly gas. Breathing carbon monoxide can cause headaches, dizziness, drowsiness, nausea, confusion, and eventually death.

Carbon Monoxide is a colorless, odorless, tasteless gas which may be present even if you do not see or smell any engine exhaust. Deadly levels of carbon monoxide can collect rapidly and you can quickly be overcome and unable to save yourself. Also, deadly levels of carbon monoxide can linger for hours or days in enclosed or poorly ventilated areas. If you experience any symptoms of carbon monoxide poisoning, leave the area immediately, get fresh air, and **SEEK MEDICAL TREATMENT.**

- Do not run engine indoors. Even if you try to ventilate engine exhaust with fans or open windows and doors, carbon monoxide can rapidly reach dangerous levels.

# SAFETY INFORMATION

1

- Do not run engine in poorly ventilated or partially enclosed areas such as barns, garages, or carports.
- Do not run engine outdoors where engine exhaust can be drawn into a building through openings such as windows and doors.

## Loading

Adding accessories or cargo to your motorcycle can adversely affect stability and handling if the weight distribution of the motorcycle is changed. To avoid the possibility of an accident, use extreme caution when adding cargo or accessories to your motorcycle. Use extra care when riding a motorcycle that has added cargo or accessories. Here, along with the information about accessories below, are some general guidelines to follow if loading cargo to your motorcycle:

The total weight of the operator, passenger, accessories and cargo must not exceed the maximum load limit.

**Operation of an overloaded vehicle could cause an accident.**

### Maximum load:

XJ6N 195 kg (430 lb)  
XJ6NA 190 kg (419 lb)

When loading within this weight limit, keep the following in mind:

- Cargo and accessory weight should be kept as low and close to the motorcycle as possible. Securely pack your heaviest items as close to the center of the vehicle as possible and make sure to distribute the weight as evenly as possible on both sides of the motorcycle to minimize imbalance or instability.
- Shifting weights can create a sudden imbalance. Make sure that accessories and cargo are securely attached to the motorcycle before riding. Check accessory mounts and cargo restraints frequently.
  - Properly adjust the suspension for your load (suspension-adjustable models only), and check the condition and pressure of your tires.

- Never attach any large or heavy items to the handlebar, front fork, or front fender. These items, including such cargo as sleeping bags, duffel bags, or tents, can create unstable handling or a slow steering response.
- **This vehicle is not designed to pull a trailer or to be attached to a sidecar.**

## Genuine Yamaha Accessories

Choosing accessories for your vehicle is an important decision. Genuine Yamaha accessories, which are available only from a Yamaha dealer, have been designed, tested, and approved by Yamaha for use on your vehicle. Many companies with no connection to Yamaha manufacture parts and accessories or offer other modifications for Yamaha vehicles. Yamaha is not in a position to test the products that these aftermarket companies produce. Therefore, Yamaha can neither endorse nor recommend the use of accessories not sold by Yamaha or

modifications not specifically recommended by Yamaha, even if sold and installed by a Yamaha dealer.

### **Aftermarket Parts, Accessories, and Modifications**

While you may find aftermarket products similar in design and quality to genuine Yamaha accessories, recognize that some aftermarket accessories or modifications are not suitable because of potential safety hazards to you or others. Installing aftermarket products or having other modifications performed to your vehicle that change any of the vehicle's design or operation characteristics can put you and others at greater risk of serious injury or death. You are responsible for injuries related to changes in the vehicle.

Keep the following guidelines in mind, as well as those provided under "Loading" when mounting accessories.

- Never install accessories or carry cargo that would impair the performance of your motorcycle. Carefully inspect the accessory before using it to make sure that it does not in any way reduce ground

clearance or cornering clearance, limit suspension travel, steering travel or control operation, or obscure lights or reflectors.

- Accessories fitted to the handlebar or the front fork area can create instability due to improper weight distribution or aerodynamic changes. If accessories are added to the handlebar or front fork area, they must be as lightweight as possible and should be kept to a minimum.
- Bulky or large accessories may seriously affect the stability of the motorcycle due to aerodynamic effects. Wind may attempt to lift the motorcycle, or the motorcycle may become unstable in cross winds. These accessories may also cause instability when passing or being passed by large vehicles.
- Certain accessories can displace the operator from his or her normal riding position. This improper position limits the freedom of movement of the opera-

tor and may limit control ability, therefore, such accessories are not recommended.

- Use caution when adding electrical accessories. If electrical accessories exceed the capacity of the motorcycle's electrical system, an electric failure could result, which could cause a dangerous loss of lights or engine power.

### **Aftermarket Tires and Rims**

The tires and rims that came with your motorcycle were designed to match the performance capabilities and to provide the best combination of handling, braking, and comfort. Other tires, rims, sizes, and combinations may not be appropriate. Refer to page 6-19 for tire specifications and more information on replacing your tires.

### **Transporting the Motorcycle**

Be sure to observe following instructions before transporting the motorcycle in another vehicle.

- Remove all loose items from the motorcycle.

## SAFETY INFORMATION

---

1

- Check that the fuel cock (if equipped) is in the “OFF” position and that there are no fuel leaks.
- Point the front wheel straight ahead on the trailer or in the truck bed, and choke it in a rail to prevent movement.
- Shift the transmission in gear (for models with a manual transmission).
- Secure the motorcycle with tie-downs or suitable straps that are attached to solid parts of the motorcycle, such as the frame or upper front fork triple clamp (and not, for example, to rubber-mounted handlebars or turn signals, or parts that could break). Choose the location for the straps carefully so the straps will not rub against painted surfaces during transport.
- The suspension should be compressed somewhat by the tie-downs, if possible, so that the motorcycle will not bounce excessively during transport.

## Left view

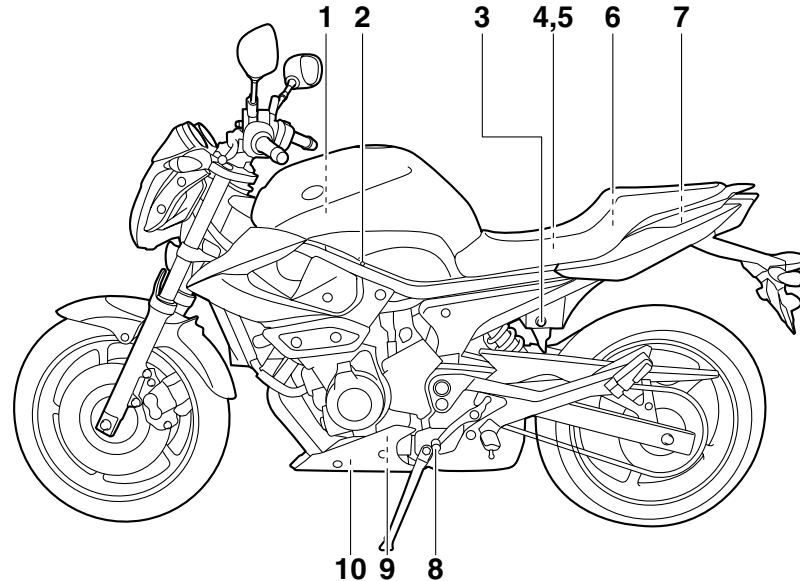

1. Air filter element (page 6-17)
2. Idle adjusting screw (page 6-18)
3. Seat lock (page 3-18)
4. Main fuse (page 6-34)
5. Fuse box (page 6-34)
6. Owner's tool kit (page 6-2)
7. Storage compartment (page 3-19)
8. Shift pedal (page 3-13)

9. Engine oil filter cartridge (page 6-10)
10. Engine oil drain bolt (page 6-10)

# DESCRIPTION

EAU10420

## Right view

2

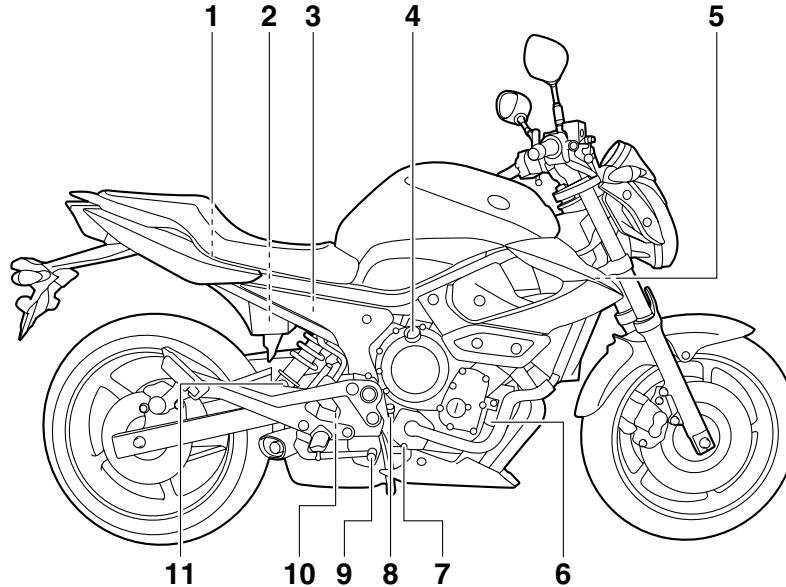

1. Helmet holder (page 3-19)
2. Battery (page 6-32)
3. Rear brake fluid reservoir (page 6-25)
4. Engine oil filler cap (page 6-10)
5. Radiator cap (page 6-13)
6. Coolant reservoir (page 6-13)
7. Coolant drain bolt (page 6-14)
8. Engine oil dipstick (page 6-10)

9. Brake pedal (page 3-14)
10. Rear brake light switch (page 6-24)
11. Shock absorber assembly spring preload adjusting ring (page 3-20)

## Controls and instruments

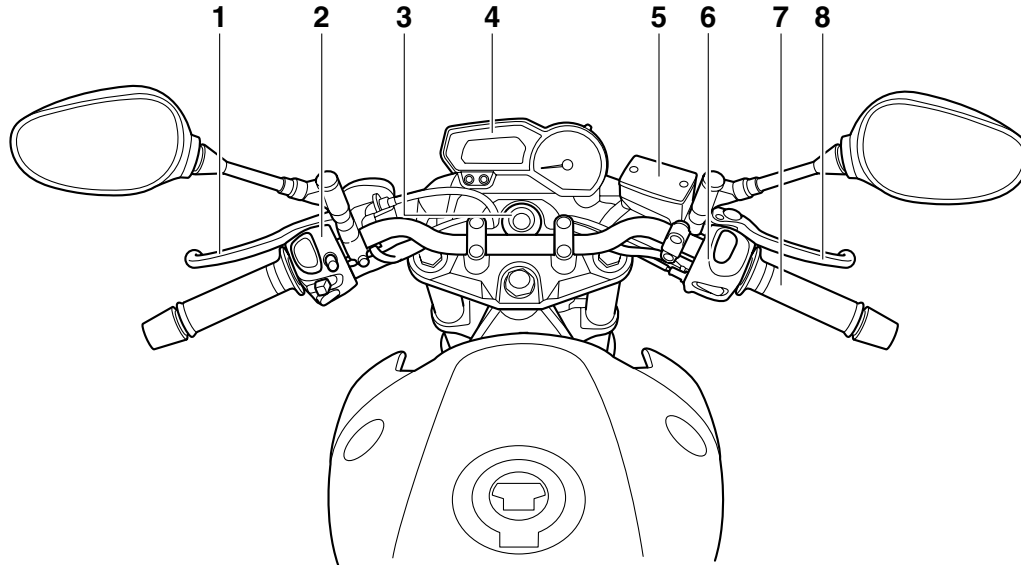

1. Clutch lever (page 3-13)
2. Left handlebar switches (page 3-12)
3. Main switch/steering lock (page 3-2)
4. Multi-function meter unit (page 3-8)
5. Front brake fluid reservoir (page 6-25)
6. Right handlebar switches (page 3-12)
7. Throttle grip (page 6-19)
8. Brake lever (page 3-14)

# INSTRUMENT AND CONTROL FUNCTIONS

## Immobilizer system

EAU10977

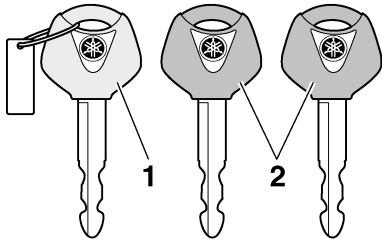

1. Code re-registering key (red bow)
2. Standard keys (black bow)

This vehicle is equipped with an immobilizer system to help prevent theft by re-registering codes in the standard keys. This system consists of the following:

- a code re-registering key (with a red bow)
- two standard keys (with a black bow) that can be re-registered with new codes
- a transponder (which is installed in the code re-registering key)
- an immobilizer unit
- an ECU

- an immobilizer system indicator light (See page 3-7.)

The key with the red bow is used to register codes in each standard key. Since re-registering is a difficult process, take the vehicle along with all three keys to a Yamaha dealer to have them re-registered. Do not use the key with the red bow for driving. It should only be used for re-registering the standard keys. Always use a standard key for driving.

ECA11821

### NOTICE

- **DO NOT LOSE THE CODE RE-REGISTERING KEY! CONTACT YOUR DEALER IMMEDIATELY IF IT IS LOST!** If the code re-registering key is lost, registering new codes in the standard keys is impossible. The standard keys can still be used to start the vehicle, however if code re-registering is required (i.e., if a new standard key is made or all keys are lost) the entire immobilizer system must be replaced. Therefore, it is highly recom-

mended to use either standard key and keep the code re-registering key in a safe place.

- Do not submerge any key in water.
- Do not expose any key to excessively high temperatures.
- Do not place any key close to magnets (this includes, but not limited to, products such as speakers, etc.).
- Do not place items that transmit electrical signals close to any key.
- Do not place heavy items on any key.
- Do not grind any key or alter its shape.
- Do not disassemble the plastic part of any key.
- Do not put two keys of any immobilizer system on the same key ring.
- Keep the standard keys as well as keys of other immobilizer systems away from this vehicle's code re-registering key.



# INSTRUMENT AND CONTROL FUNCTIONS

- Keep other immobilizer system keys away from the main switch as they may cause signal interference.

## Main switch/steering lock

EAU10472

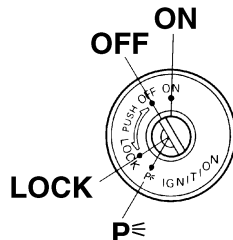

The main switch/steering lock controls the ignition and lighting systems, and is used to lock the steering. The various positions are described below.

### TIP

Be sure to use the standard key (black bow) for regular use of the vehicle. To minimize the risk of losing the code re-registering key (red bow), keep it in a safe place and only use it for code re-registering.

### ON

All electrical circuits are supplied with power; the meter lighting, taillight, license plate light and auxiliary light come on, and the engine can be started. The key cannot be removed.

### TIP

The headlight comes on automatically when the engine is started and stays on until the key is turned to "OFF", even if the engine stalls.

### OFF

All electrical systems are off. The key can be removed.

### **WARNING**

**Never turn the key to "OFF" or "LOCK" while the vehicle is moving. Otherwise the electrical systems will be switched off, which may result in loss of control or an accident.**

EAU38530

EAU10661

EWA10061

# INSTRUMENT AND CONTROL FUNCTIONS

EAU10683

## LOCK

The steering is locked, and all electrical systems are off. The key can be removed.

### To lock the steering

3

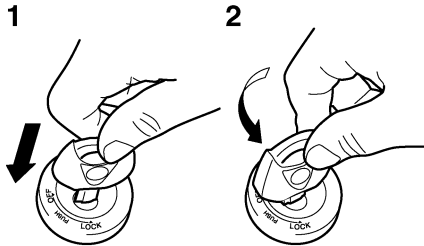

1. Push.
2. Turn.
  1. Turn the handlebars all the way to the left.
  2. Push the key in from the “OFF” position, and then turn it to “LOCK” while still pushing it.
  3. Remove the key.

### To unlock the steering

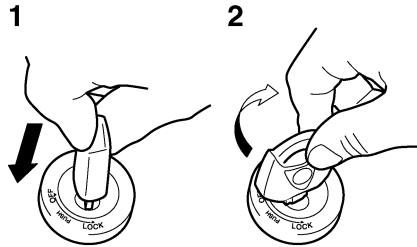

1. Push.
2. Turn.

Push the key in, and then turn it to “OFF” while still pushing it.

EAU34341

### **p<sub>≡</sub>** (Parking)

The steering is locked, and the taillight, license plate light and auxiliary light are on. The hazard lights and turn signal lights can be turned on, but all other electrical systems are off. The key can be removed.

The steering must be locked before the key can be turned to “p<sub>≡</sub>”.

ECA11020

## NOTICE

Do not use the parking position for an extended length of time, otherwise the battery may discharge.

## Indicator lights and warning lights

EAU49391

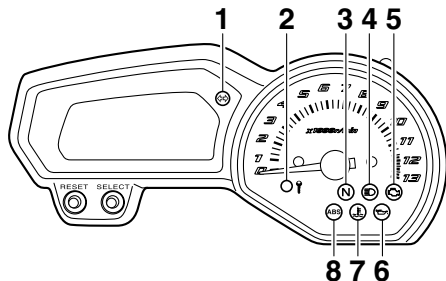

1. Turn signal indicator light “↔”
2. Immobilizer system indicator light
3. Neutral indicator light “N”
4. High beam indicator light “≡D”
5. Engine trouble warning light “H”
6. Oil level warning light “油”
7. Coolant temperature warning light “水”
8. Anti-lock Brake System (ABS) warning light “(ABS)” (for ABS models)

EAU11020

### Turn signal indicator light “↔”

This indicator light flashes when the turn signal switch is pushed to the left or right.

### Neutral indicator light “N”

EAU11060

This indicator light comes on when the transmission is in the neutral position.

### High beam indicator light “≡D”

EAU11080

This indicator light comes on when the high beam of the headlight is switched on.

### Oil level warning light “油”

EAU11254

This warning light comes on if the engine oil level is low.

The electrical circuit of the warning light can be checked by turning the key to “ON”. The warning light should come on for a few seconds, and then go off. If the warning light does not come on initially when the key is turned to “ON”, or if the warning light remains on, have a Yamaha dealer check the electrical circuit.

### TIP

- Even if the oil level is sufficient, the warning light may flicker when riding on a slope or during sudden acceleration or deceleration, but this is not a malfunction.

- This model is also equipped with a self-diagnosis device for the oil level detection circuit. If a problem is detected in the oil level detection circuit, the following cycle will be repeated until the malfunction is corrected: The oil level warning light will flash ten times, then go off for 2.5 seconds. If this occurs, have a Yamaha dealer check the vehicle.

### Coolant temperature warning light “水”

EAU11428

This warning light comes on if the engine overheats. If this occurs, stop the engine immediately and allow the engine to cool.

The electrical circuit of the warning light can be checked by turning the key to “ON”. The warning light should come on for a few seconds, and then go off.

If the warning light does not come on initially when the key is turned to “ON”, or if the warning light remains on, have a Yamaha dealer check the electrical circuit.

# INSTRUMENT AND CONTROL FUNCTIONS

---

---

ECA10021

## **NOTICE**

---

**Do not continue to operate the engine if it is overheating.**

---

## **TIP**

---

- For radiator-fan-equipped vehicles, the radiator fan(s) automatically switch on or off according to the coolant temperature in the radiator.
  - If the engine overheats, see page 6-45 for further instructions.
-

# INSTRUMENT AND CONTROL FUNCTIONS

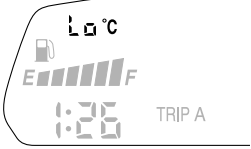
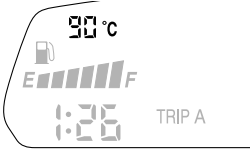
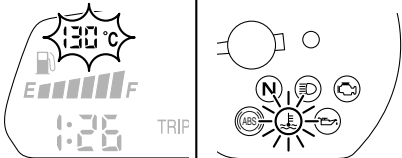
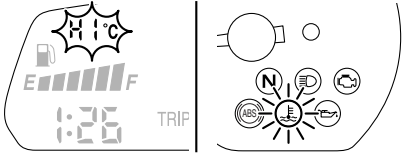
	Display	Conditions	What to do
<p>Under 39 °C (Under 103 °F)</p>		<p>Message “Lo” is displayed.</p>	<p>OK. Go ahead with riding.</p>
<p>40–116 °C (104–242 °F)</p>		<p>Coolant temperature is displayed.</p>	<p>OK. Go ahead with riding.</p>
<p>117–134 °C (243–274 °F)</p>		<p>Coolant temperature flashes. Warning light comes on.</p>	<p>Stop the vehicle and allow it to idle until the coolant temperature goes down. If the temperature does not go down, stop the engine. (See page 6-45.)</p>
<p>Above 135 °C (Above 275 °F)</p>		<p>Message “HI” flashes. Warning light comes on.</p>	<p>Stop the engine and allow it to cool. (See page 6-45.)</p>

# INSTRUMENT AND CONTROL FUNCTIONS

3

## Engine trouble warning light “” EAU11534

This warning light comes on or flashes if a problem is detected in the electrical circuit monitoring the engine. If this occurs, have a Yamaha dealer check the self-diagnosis system. (See page 3-10 for an explanation of the self-diagnosis device.)

The electrical circuit of the warning light can be checked by turning the key to “ON”. The warning light should come on for a few seconds, and then go off. If the warning light does not come on initially when the key is turned to “ON”, or if the warning light remains on, have a Yamaha dealer check the electrical circuit.

## ABS warning light “” (for ABS models) EAU11545

If this warning light comes on or flashes while riding, the ABS may not work correctly. If this occurs, have a Yamaha dealer check the system as soon as possible. (See page 3-14.)

## **WARNING**

**If the ABS warning light comes on or flashes while riding, the brake system reverts to conventional braking. Therefore, be careful not to cause the wheels to lock during emergency braking. If the warning light comes on or flashes while riding, have a Yamaha dealer check the brake system as soon as possible.**

The electrical circuit of the warning light can be checked by turning the key to “ON”. The warning light should come on for a few seconds, and then go off. If the warning light does not come on initially when the key is turned to “ON”, or if the warning light remains on, have a Yamaha dealer check the electrical circuit.

## **Immobilizer system indicator light** EAU38624

The electrical circuit of the indicator light can be checked by turning the key to “ON”. The indicator light should come on for a few seconds, and then go off.

EWA10081

If the indicator light does not come on initially when the key is turned to “ON”, or if the indicator light remains on, have a Yamaha dealer check the electrical circuit.

When the key is turned to “OFF” and 30 seconds have passed, the indicator light will start flashing indicating the immobilizer system is enabled. After 24 hours have passed, the indicator light will stop flashing, however the immobilizer system is still enabled.

The self-diagnosis device also detects problems in the immobilizer system circuits. (See page 3-10 for an explanation of the self-diagnosis device.)

## Multi-function meter unit

EAU46765

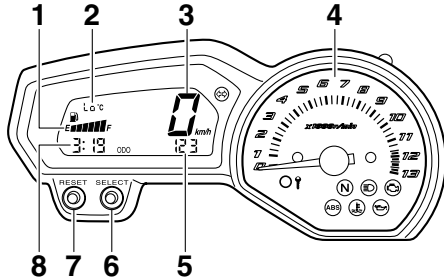

1. Fuel meter
2. Coolant temperature display
3. Speedometer
4. Tachometer
5. Odometer/tripmeter/fuel reserve tripmeter
6. "SELECT" button
7. "RESET" button
8. Clock

EWA12422

### **WARNING**

Be sure to stop the vehicle before making any setting changes to the multi-function meter unit. Changing settings while riding can distract the operator and increase the risk of an accident.

The multi-function meter unit is equipped with the following:

- a speedometer
- a tachometer
- an odometer
- two tripmeters (which show the distance traveled since they were last set to zero)
- a fuel reserve tripmeter (which shows the distance traveled since the left segment of the fuel meter started flashing)
- a clock
- a fuel meter
- a coolant temperature display
- a self-diagnosis device

### TIP

- Be sure to turn the key to "ON" before using the "SELECT" and "RESET" buttons.
- For the U.K. only: To switch the speedometer and odometer/tripmeter displays between kilometers and miles, press the "SELECT" button for at least one second.

## Tachometer

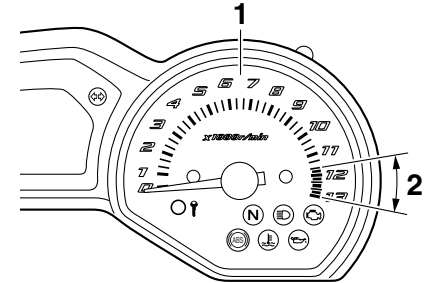

1. Tachometer
2. Tachometer red zone

The electric tachometer allows the rider to monitor the engine speed and keep it within the ideal power range.

When the key is turned to "ON", the tachometer needle will sweep once across the r/min range and then return to zero r/min in order to test the electrical circuit.

ECA10031

### **NOTICE**

Do not operate the engine in the tachometer red zone.

**Red zone: 11666 r/min and above**

# INSTRUMENT AND CONTROL FUNCTIONS

## Clock

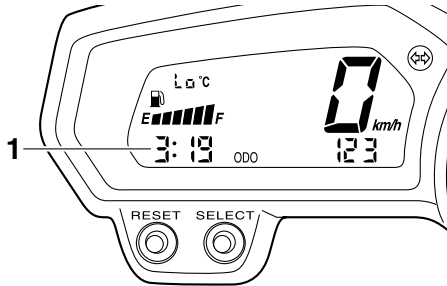

1. Clock

The clock displays when the key is turned to “ON”. In addition, the clock can be displayed for 10 seconds by pushing the “SELECT” button when the main switch is in the “OFF”, “LOCK” or “ $\rho$ ” position.

### To set the clock

1. Turn the key to “ON”.
2. Push the “SELECT” button and “RESET” button together for at least two seconds.
3. When the hour digits start flashing, push the “RESET” button to set the hours.
4. Push the “SELECT” button, and the minute digits will start flashing.

5. Push the “RESET” button to set the minutes.
6. Push the “SELECT” button and then release it to start the clock.

## Odometer and tripmeter modes

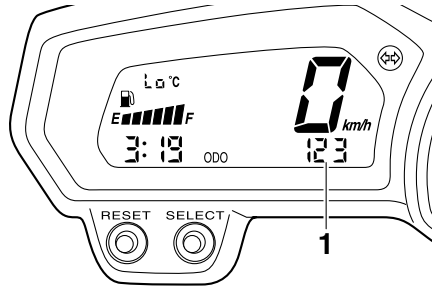

1. Odometer/tripmeter/fuel reserve tripmeter

Push the “SELECT” button to switch the display between the odometer mode “ODO” and the tripmeter modes “TRIP A” and “TRIP B” in the following order:

TRIP A → TRIP B → ODO → TRIP A  
When the fuel amount in the fuel tank decreases to 3.2 L (0.85 US gal, 0.70 Imp.gal), the left segment of the fuel meter will start flashing, and the odometer display will automatically change to the fuel reserve tripmeter

mode “F-TRIP” and start counting the distance traveled from that point. In that case, push the “SELECT” button to switch the display between the various tripmeter and odometer modes in the following order:

F-TRIP → TRIP A → TRIP B → ODO → F-TRIP

To reset a tripmeter, select it by pushing the “SELECT” button, and then push the “RESET” button for at least one second. If you do not reset the fuel reserve tripmeter manually, it will reset itself automatically and the display will return to the prior mode after refueling and traveling 5 km (3 mi).

## Fuel meter

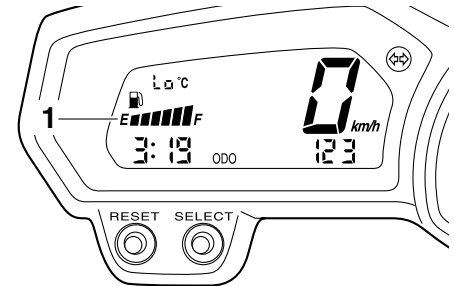

1. Fuel meter



# INSTRUMENT AND CONTROL FUNCTIONS

The fuel meter indicates the amount of fuel in the fuel tank. The display segments of the fuel meter disappear towards “E” (Empty) as the fuel level decreases. When the last segment on the left starts flashing, refuel as soon as possible.

## TIP

This fuel meter is equipped with a self-diagnosis system. If a problem is detected in the electrical circuit, the following cycle is repeated until the malfunction is corrected: fuel level segments and symbol “

## Coolant temperature display

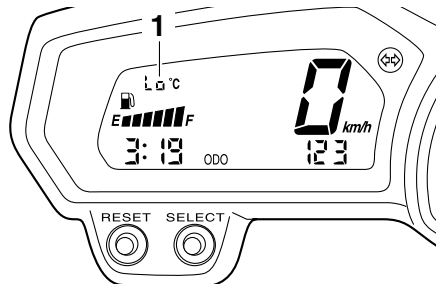

1. Coolant temperature display

The coolant temperature display indicates the temperature of the coolant.

ECA10021

## NOTICE

**Do not continue to operate the engine if it is overheating.**

## Self-diagnosis device

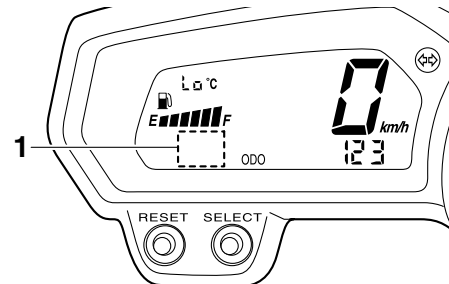

1. Error code display

This model is equipped with a self-diagnosis device for various electrical circuits.

If a problem is detected in any of those circuits, the engine trouble warning light will come on and the display will indicate an error code.

If the display indicates any error codes, note the code number, and then have a Yamaha dealer check the vehicle.

The self-diagnosis device also detects problems in the immobilizer system circuits.

If a problem is detected in the immobilizer system circuits, the immobilizer system indicator light will flash and the display will indicate an error code.

# INSTRUMENT AND CONTROL FUNCTIONS

---

---

ECA11590

EAU12331

## TIP \_\_\_\_\_

If the display indicates error code 52, this could be caused by transponder interference. If this error code appears, try the following.

1. Use the code re-registering key to start the engine.

## TIP \_\_\_\_\_

Make sure there are no other immobilizer keys close to the main switch, and do not keep more than one immobilizer key on the same key ring! Immobilizer system keys may cause signal interference, which may prevent the engine from starting.

2. If the engine starts, turn it off and try starting the engine with the standard keys.
3. If one or both of the standard keys do not start the engine, take the vehicle, the code re-registering key and both standard keys to a Yamaha dealer and have the standard keys re-registered.

## NOTICE \_\_\_\_\_

**If the display indicates an error code, the vehicle should be checked as soon as possible in order to avoid engine damage.**

## Anti-theft alarm (optional)





This model can be equipped with an optional anti-theft alarm by a Yamaha dealer. Contact a Yamaha dealer for more information.

# INSTRUMENT AND CONTROL FUNCTIONS

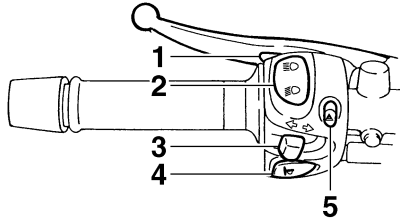
## Handlebar switches

### Left

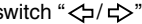



1. Pass switch “ ”
2. Dimmer switch “ ”
3. Turn signal switch “ ”
4. Horn switch “ ”
5. Hazard switch “ ”

EAU12348

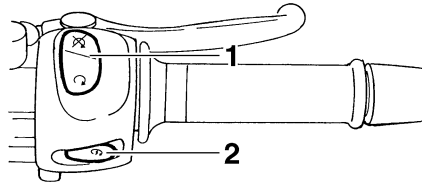
### Right





1. Engine stop switch “ /  ”
2. Start switch “ ”

### Pass switch “ ”

Press this switch to flash the headlight.



EAU12350

### Dimmer switch “ / ”

Set this switch to “ ” for the high beam and to “ ” for the low beam.

EAU12400

### Turn signal switch “ / ”

To signal a right-hand turn, push this switch to “ ”. To signal a left-hand turn, push this switch to “ ”. When released, the switch returns to the center

EAU12460



position. To cancel the turn signal lights, push the switch in after it has returned to the center position.

### Horn switch “ ”

Press this switch to sound the horn.

EAU12500

### Engine stop switch “ / ”

Set this switch to “ ” before starting the engine. Set this switch to “ ” to stop the engine in case of an emergency, such as when the vehicle overturns or when the throttle cable is stuck.

EAU12660

3

### Start switch “ ”

Push this switch to crank the engine with the starter. See page 5-1 for starting instructions prior to starting the engine.

EAU12711

The engine trouble warning light and ABS warning light (ABS model only) will come on when the key is turned to “ON” and the start switch is pushed, but this does not indicate a malfunction.

EAU44710

# INSTRUMENT AND CONTROL FUNCTIONS

3

## Hazard switch “”

EAU12733

With the key in the “ON” or “ $\rho$ ” position, use this switch to turn on the hazard lights (simultaneous flashing of all turn signal lights).

The hazard lights are used in case of an emergency or to warn other drivers when your vehicle is stopped where it might be a traffic hazard.

ECA10061

### **NOTICE**

**Do not use the hazard lights for an extended length of time with the engine not running, otherwise the battery may discharge.**

## Clutch lever

EAU12820

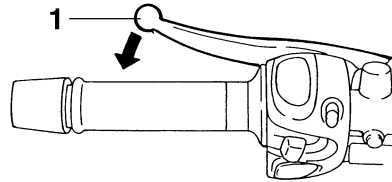

1. Clutch lever

The clutch lever is located at the left handlebar grip. To disengage the clutch, pull the lever toward the handlebar grip. To engage the clutch, release the lever. The lever should be pulled rapidly and released slowly for smooth clutch operation.

The clutch lever is equipped with a clutch switch, which is part of the ignition circuit cut-off system. (See page 3-22.)

## Shift pedal

EAU12871

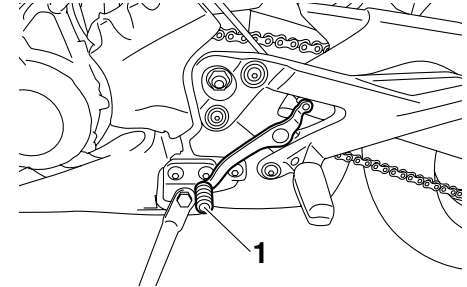

1. Shift pedal

The shift pedal is located on the left side of the motorcycle and is used in combination with the clutch lever when shifting the gears of the 6-speed constant-mesh transmission equipped on this motorcycle.

EAU26823

## Brake lever

The brake lever is located at the right handlebar grip. To apply the front brake, pull the lever toward the handlebar grip.

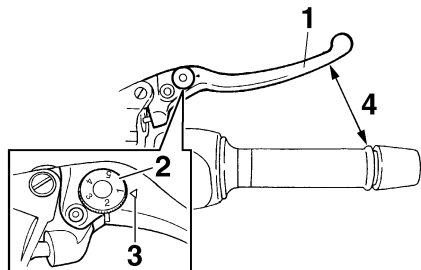

1. Brake lever
2. Brake lever position adjusting dial
3. “△” mark
4. Distance between brake lever and handlebar grip

The brake lever is equipped with a brake lever position adjusting dial. To adjust the distance between the brake lever and the handlebar grip, turn the adjusting dial while holding the lever pushed away from the handlebar grip. Make sure that the appropriate setting on the adjusting dial is aligned with the “△” mark on the brake lever.

EAU12941

## Brake pedal

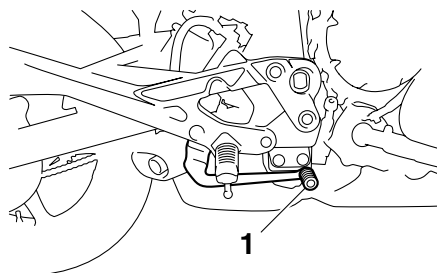

1. Brake pedal

The brake pedal is on the right side of the motorcycle. To apply the rear brake, press down on the brake pedal.

EAU47521

## ABS (for ABS models)

The Yamaha ABS (Anti-lock Brake System) features a dual electronic control system, which acts on the front and rear brakes independently. The ABS is monitored by an ECU, which will have recourse to manual braking if a malfunction occurs.

EWA10090

### **⚠ WARNING**

- The ABS performs best on long braking distances.
- On certain (rough or gravel) roads, the braking distance may be longer with than without the ABS. Therefore, always keep a sufficient distance to the vehicle ahead to match the riding speed.

### **TIP**

- The ABS performs a self-diagnosis test for a few seconds each time the vehicle first starts off after the key was turned to “ON”. During this test, a “clicking” noise can be heard from under the seat, and if the brake lever or brake pedal are

# INSTRUMENT AND CONTROL FUNCTIONS

even slightly applied, a vibration can be felt at the lever and pedal, but these do not indicate a malfunction.

- When the ABS is activated, the brakes are operated in the usual way. A pulsating action may be felt at the brake lever or brake pedal, but this does not indicate a malfunction.
- This ABS has a test mode which allows the owner to experience the pulsating at the brake lever or brake pedal when the ABS is operating. However, special tools are required, so please consult your Yamaha dealer when performing this test.

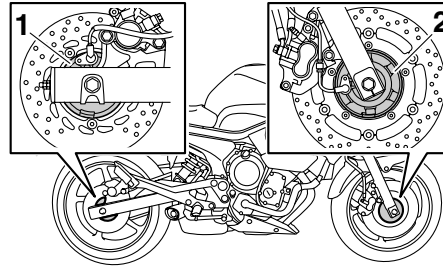

1. Rear wheel hub
2. Front wheel hub

ECA16120

## NOTICE

**Keep any type of magnets (including magnetic pick-up tools, magnetic screwdrivers, etc.) away from the front and rear wheel hubs, otherwise the magnetic rotors equipped in the wheel hubs may be damaged, resulting in improper performance of the ABS system.**

EAU13074

## Fuel tank cap

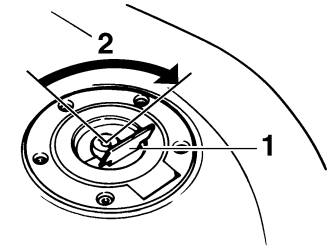

1. Fuel tank cap lock cover
2. Unlock.

### To open the fuel tank cap

Open the fuel tank cap lock cover, insert the key into the lock, and then turn it 1/4 turn clockwise. The lock will be released and the fuel tank cap can be opened.

### To close the fuel tank cap

1. Push the fuel tank cap into position with the key inserted in the lock.
2. Turn the key counterclockwise to the original position, remove it, and then close the lock cover.

# INSTRUMENT AND CONTROL FUNCTIONS

## TIP \_\_\_\_\_

The fuel tank cap cannot be closed unless the key is in the lock. In addition, the key cannot be removed if the cap is not properly closed and locked.

EWA11091

## WARNING \_\_\_\_\_

Make sure that the fuel tank cap is properly closed after filling fuel. Leaking fuel is a fire hazard.

## Fuel

Make sure there is sufficient gasoline in the tank.

EAU13221

EWA10881

## WARNING \_\_\_\_\_

Gasoline and gasoline vapors are extremely flammable. To avoid fires and explosions and to reduce the risk of injury when refueling, follow these instructions.

1. Before refueling, turn off the engine and be sure that no one is sitting on the vehicle. Never refuel while smoking, or while in the vicinity of sparks, open flames, or other sources of ignition such as the pilot lights of water heaters and clothes dryers.
2. Do not overfill the fuel tank. When refueling, be sure to insert the pump nozzle into the fuel tank filler hole. Stop filling when the fuel reaches the bottom of the filler tube. Because fuel expands when it heats up, heat from the engine or the sun can cause fuel to spill out of the fuel tank.

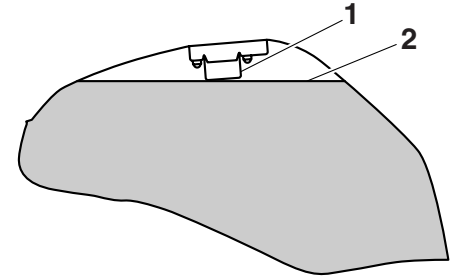

1. Fuel tank filler tube
2. Maximum fuel level

3. Wipe up any spilled fuel immediately. **NOTICE: Immediately wipe off spilled fuel with a clean, dry, soft cloth, since fuel may deteriorate painted surfaces or plastic parts.** [ECA10071]
4. Be sure to securely close the fuel tank cap.

EWA15151

## WARNING \_\_\_\_\_

Gasoline is poisonous and can cause injury or death. Handle gasoline with care. Never siphon gasoline by mouth. If you should swallow some gasoline or inhale a lot of gasoline vapor, or get some gasoline in your eyes, see your doctor immedi-

# INSTRUMENT AND CONTROL FUNCTIONS

ately. If gasoline spills on your skin, wash with soap and water. If gasoline spills on your clothing, change your clothes.

EAU13321

## Recommended fuel:

Regular unleaded gasoline only

## Fuel tank capacity:

17.3 L (4.57 US gal, 3.81 Imp.gal)

## Fuel reserve amount:

3.2 L (0.85 US gal, 0.70 Imp.gal)

ECA11400

## NOTICE

**Use only unleaded gasoline. The use of leaded gasoline will cause severe damage to internal engine parts, such as the valves and piston rings, as well as to the exhaust system.**

Your Yamaha engine has been designed to use regular unleaded gasoline with a research octane number of 91 or higher. If knocking (or pinging) occurs, use a gasoline of a different brand or premium unleaded fuel. Use of unleaded fuel will extend spark plug life and reduce maintenance costs.

## Fuel tank breather/overflow hose

EAU13300

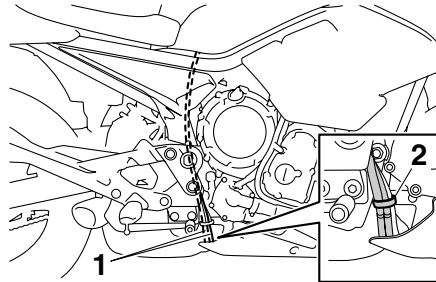

1. Fuel tank breather/overflow hose
2. Clamp

Before operating the motorcycle:

- Check the fuel tank breather/overflow hose connection.
- Check the fuel tank breather/overflow hose for cracks or damage, and replace it if damaged.
- Make sure that the end of the fuel tank breather/overflow hose is not blocked, and clean it if necessary.
- Make sure that the end of the fuel tank breather/overflow hose is positioned inside of the clamp.

## Catalytic converter

EAU13433

This model is equipped with a catalytic converter in the exhaust system.

EWA10862

## ⚠ WARNING

**The exhaust system is hot after operation. To prevent a fire hazard or burns:**

- Do not park the vehicle near possible fire hazards such as grass or other materials that easily burn.
- Park the vehicle in a place where pedestrians or children are not likely to touch the hot exhaust system.
- Make sure that the exhaust system has cooled down before doing any maintenance work.
- Do not allow the engine to idle more than a few minutes. Long idling can cause a build-up of heat.



# INSTRUMENT AND CONTROL FUNCTIONS

## NOTICE

Use only unleaded gasoline. The use of leaded gasoline will cause unreparable damage to the catalytic converter.

ECA10701

## Seat

EAU32980

### To remove the seat

1. Insert the key into the seat lock, and then turn it counterclockwise.

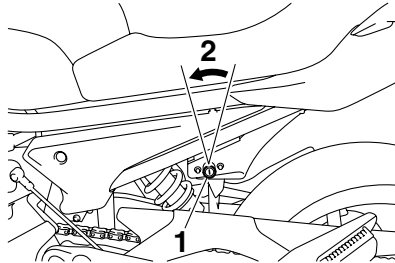

1. Seat lock
2. Unlock.

2. While holding the key in that position, lift the rear of the seat up, and then pull the seat off.

### To install the seat

1. Insert the projection on the front of the seat into the seat holder as shown.

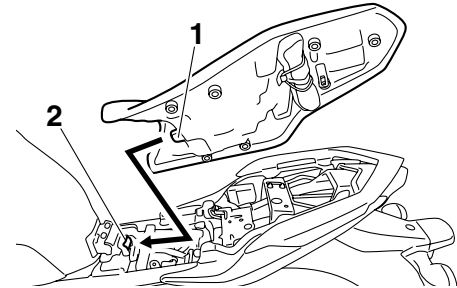

1. Projection
2. Seat holder

2. Push the rear of the seat down to lock it in place.
3. Remove the key.

### TIP

Make sure that the seat is properly secured before riding.

3

# INSTRUMENT AND CONTROL FUNCTIONS

## Helmet holder

EAU46751

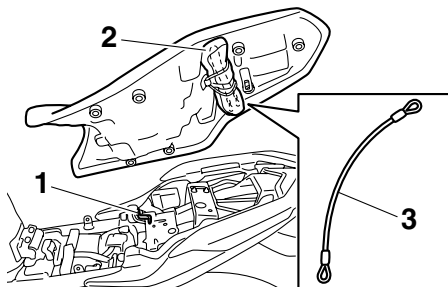

1. Helmet holder
2. Owner's tool kit
3. Helmet holding cable

The helmet holder is located under the seat. A helmet holding cable is provided in the owner's tool kit to secure a helmet to the helmet holder.

### To secure a helmet to the helmet holder

1. Remove the seat. (See page 3-18.)
2. Pass the helmet holding cable through the buckle on the helmet strap as shown, and then hook the cable loops over the helmet holder.

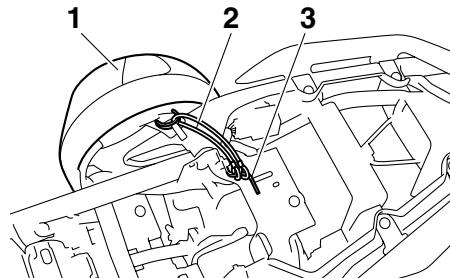

1. Helmet
2. Helmet holding cable
3. Helmet holder

3. Place the helmet on the right side of the vehicle, and then install the helmet. **WARNING! Never ride with a helmet attached to the helmet holder, since the helmet may hit objects, causing loss of control and possibly an accident.** [EWA10161]

### To release the helmet from the helmet holder

Remove the seat, remove the helmet holding cable from the helmet holder and the helmet, and then install the seat.

## Storage compartment

EAU14453

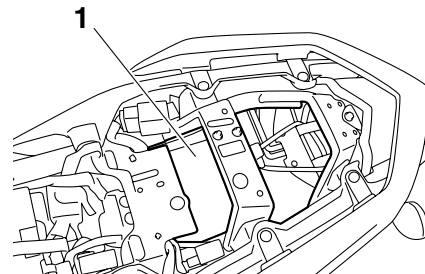

1. Storage compartment

The storage compartment is located under the seat. (See page 3-18.) When storing the Owner's Manual or other documents in the storage compartment, be sure to wrap them in a plastic bag so that they will not get wet. When washing the vehicle, be careful not to let any water enter the storage compartment.

### **! WARNING**

- Do not exceed the load limit of 3 kg (7 lb) for the storage compartment.

EWA10961

# INSTRUMENT AND CONTROL FUNCTIONS

- Do not exceed the maximum load of XJ6N 195 kg (430 lb) XJ6NA 190 kg (419 lb) for the vehicle.

## Handlebar position

EAU46831

The handlebar can be adjusted to one of two positions to suit the rider's preference. Have a Yamaha dealer adjust the position of the handlebar.

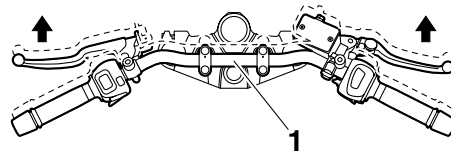

1. Handlebar

## Adjusting the shock absorber assembly

EAU47000

This shock absorber assembly is equipped with a spring preload adjusting ring.

ECA10101

### NOTICE

To avoid damaging the mechanism, do not attempt to turn beyond the maximum or minimum settings.

Adjust the spring preload as follows.

To increase the spring preload and thereby harden the suspension, turn the adjusting ring in direction (a). To decrease the spring preload and thereby soften the suspension, turn the adjusting ring in direction (b).

- Align the appropriate notch in the adjusting ring with the position indicator on the shock absorber.
- Use the special wrench and extension bar included in the owner's tool kit to make the adjustment.

# INSTRUMENT AND CONTROL FUNCTIONS

EAU15304

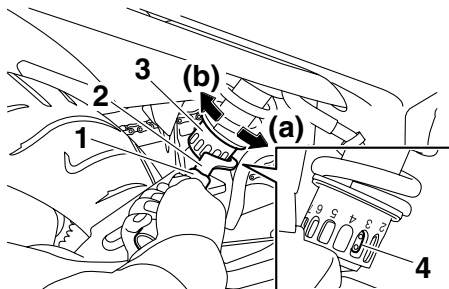

3

1. Extension bar
2. Special wrench
3. Spring preload adjusting ring
4. Position indicator

## Spring preload setting:

Minimum (soft):

1

Standard:

3

Maximum (hard):

7

EWA10221

## **WARNING**

This shock absorber assembly contains highly pressurized nitrogen gas. Read and understand the following information before handling the shock absorber assembly.

- Do not tamper with or attempt to open the cylinder assembly.
- Do not subject the shock absorber assembly to an open flame or other high heat source. This may cause the unit to explode due to excessive gas pressure.
- Do not deform or damage the cylinder in any way. Cylinder damage will result in poor damping performance.
- Do not dispose of a damaged or worn-out shock absorber assembly yourself. Take the shock absorber assembly to a Yamaha dealer for any service.

## Sidestand

The sidestand is located on the left side of the frame. Raise the sidestand or lower it with your foot while holding the vehicle upright.

### TIP

The built-in sidestand switch is part of the ignition circuit cut-off system, which cuts the ignition in certain situations. (See page 3-22 for an explanation of the ignition circuit cut-off system.)

EWA10241

## **WARNING**

The vehicle must not be ridden with the sidestand down, or if the sidestand cannot be properly moved up (or does not stay up), otherwise the sidestand could contact the ground and distract the operator, resulting in a possible loss of control. Yamaha's ignition circuit cut-off system has been designed to assist the operator in fulfilling the responsibility of raising the sidestand before starting off. Therefore, check

**this system regularly and have a Yamaha dealer repair it if it does not function properly.**

---

EAU44892

## **Ignition circuit cut-off system**

The ignition circuit cut-off system (comprising the sidestand switch, clutch switch and neutral switch) has the following functions.

- It prevents starting when the transmission is in gear and the sidestand is up, but the clutch lever is not pulled.
- It prevents starting when the transmission is in gear and the clutch lever is pulled, but the sidestand is still down.
- It cuts the running engine when the transmission is in gear and the sidestand is moved down.

Periodically check the operation of the ignition circuit cut-off system according to the following procedure.

# INSTRUMENT AND CONTROL FUNCTIONS

3

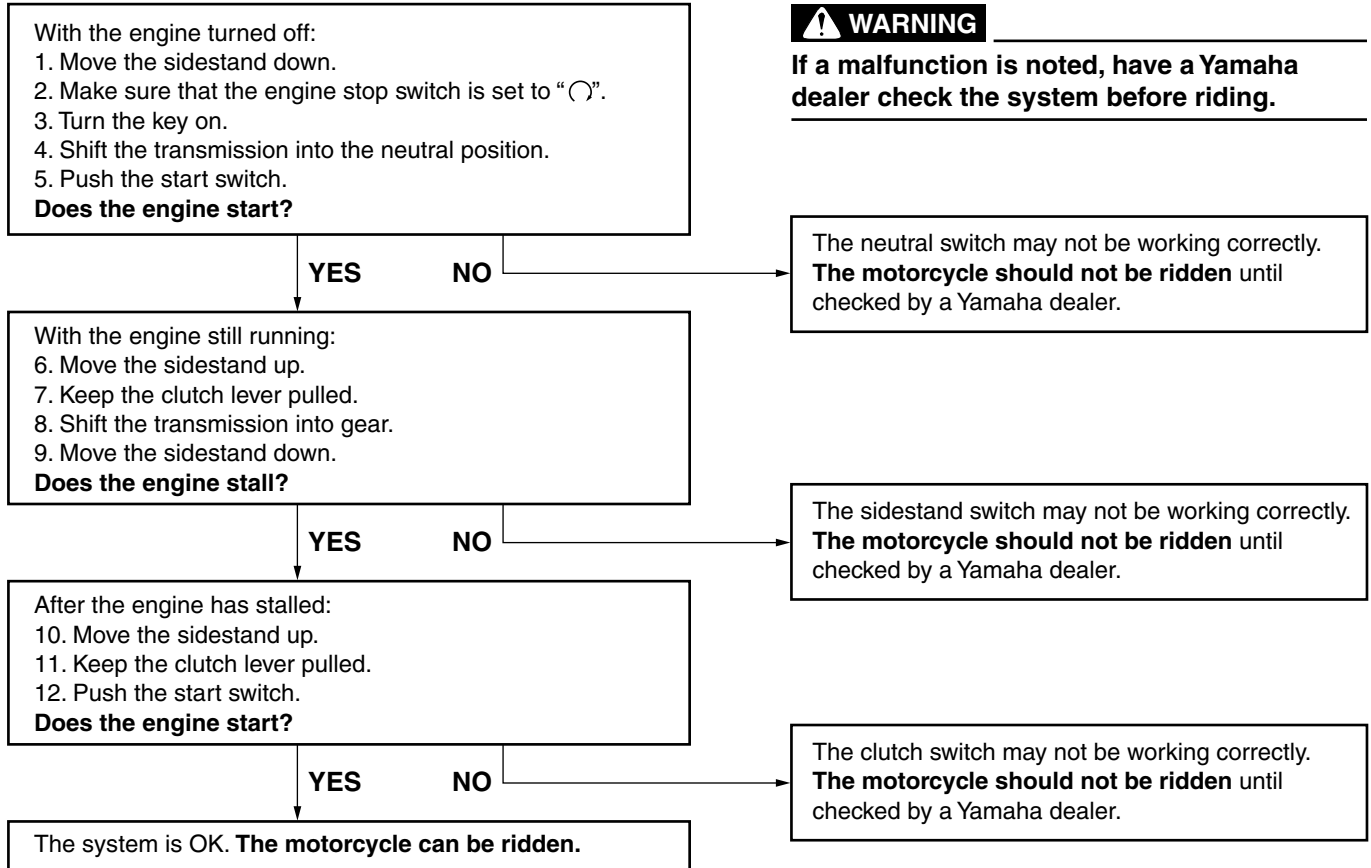

# FOR YOUR SAFETY – PRE-OPERATION CHECKS

EAU15596

Inspect your vehicle each time you use it to make sure the vehicle is in safe operating condition. Always follow the inspection and maintenance procedures and schedules described in the Owner's Manual.

EWA11151

## **WARNING**

**Failure to inspect or maintain the vehicle properly increases the possibility of an accident or equipment damage. Do not operate the vehicle if you find any problem. If a problem cannot be corrected by the procedures provided in this manual, have the vehicle inspected by a Yamaha dealer.**

Before using this vehicle, check the following points:

ITEM	CHECKS	PAGE
Fuel	<ul style="list-style-type: none"><li>• Check fuel level in fuel tank.</li><li>• Refuel if necessary.</li><li>• Check fuel line for leakage.</li><li>• Check fuel tank breather/overflow hose for obstructions, cracks or damage, and check hose connection.</li></ul>	3-16, 3-17
Engine oil	<ul style="list-style-type: none"><li>• Check oil level in engine.</li><li>• If necessary, add recommended oil to specified level.</li><li>• Check vehicle for oil leakage.</li></ul>	6-10
Coolant	<ul style="list-style-type: none"><li>• Check coolant level in reservoir.</li><li>• If necessary, add recommended coolant to specified level.</li><li>• Check cooling system for leakage.</li></ul>	6-13
Front brake	<ul style="list-style-type: none"><li>• Check operation.</li><li>• If soft or spongy, have Yamaha dealer bleed hydraulic system.</li><li>• Check brake pads for wear.</li><li>• Replace if necessary.</li><li>• Check fluid level in reservoir.</li><li>• If necessary, add recommended brake fluid to specified level.</li><li>• Check hydraulic system for leakage.</li></ul>	6-24, 6-25

# FOR YOUR SAFETY – PRE-OPERATION CHECKS

ITEM	CHECKS	PAGE
<b>Rear brake</b>	<ul style="list-style-type: none"> <li>• Check operation.</li> <li>• If soft or spongy, have Yamaha dealer bleed hydraulic system.</li> <li>• Check brake pads for wear.</li> <li>• Replace if necessary.</li> <li>• Check fluid level in reservoir.</li> <li>• If necessary, add recommended brake fluid to specified level.</li> <li>• Check hydraulic system for leakage.</li> </ul>	6-24, 6-25
<b>Clutch</b>	<ul style="list-style-type: none"> <li>• Check operation.</li> <li>• Lubricate cable if necessary.</li> <li>• Check lever free play.</li> <li>• Adjust if necessary.</li> </ul>	6-22
<b>Throttle grip</b>	<ul style="list-style-type: none"> <li>• Make sure that operation is smooth.</li> <li>• Check throttle grip free play.</li> <li>• If necessary, have Yamaha dealer adjust throttle grip free play and lubricate cable and grip housing.</li> </ul>	6-19, 6-29
<b>Control cables</b>	<ul style="list-style-type: none"> <li>• Make sure that operation is smooth.</li> <li>• Lubricate if necessary.</li> </ul>	6-28
<b>Drive chain</b>	<ul style="list-style-type: none"> <li>• Check chain slack.</li> <li>• Adjust if necessary.</li> <li>• Check chain condition.</li> <li>• Lubricate if necessary.</li> </ul>	6-26, 6-28
<b>Wheels and tires</b>	<ul style="list-style-type: none"> <li>• Check for damage.</li> <li>• Check tire condition and tread depth.</li> <li>• Check air pressure.</li> <li>• Correct if necessary.</li> </ul>	6-19, 6-22
<b>Brake and shift pedals</b>	<ul style="list-style-type: none"> <li>• Make sure that operation is smooth.</li> <li>• Lubricate pedal pivoting points if necessary.</li> </ul>	6-29
<b>Brake and clutch levers</b>	<ul style="list-style-type: none"> <li>• Make sure that operation is smooth.</li> <li>• Lubricate lever pivoting points if necessary.</li> </ul>	6-30
<b>Sidestand</b>	<ul style="list-style-type: none"> <li>• Make sure that operation is smooth.</li> <li>• Lubricate pivot if necessary.</li> </ul>	6-30



# FOR YOUR SAFETY – PRE-OPERATION CHECKS

ITEM	CHECKS	PAGE
<b>Chassis fasteners</b>	<ul style="list-style-type: none"><li>• Make sure that all nuts, bolts and screws are properly tightened.</li><li>• Tighten if necessary.</li></ul>	—
<b>Instruments, lights, signals and switches</b>	<ul style="list-style-type: none"><li>• Check operation.</li><li>• Correct if necessary.</li></ul>	—
<b>Sidestand switch</b>	<ul style="list-style-type: none"><li>• Check operation of ignition circuit cut-off system.</li><li>• If system is not working correctly, have Yamaha dealer check vehicle.</li></ul>	3-21

# OPERATION AND IMPORTANT RIDING POINTS

---

EAU15951

EAU47150

EAU44728

Read the Owner's Manual carefully to become familiar with all controls. If there is a control or function you do not understand, ask your Yamaha dealer.

EWA10271

## **WARNING**

**Failure to familiarize yourself with the controls can lead to loss of control, which could cause an accident or injury.**

---

5

## **TIP**

This model is equipped with:

- a lean angle sensor to stop the engine in case of a turnover. In this case, the multi-function meter unit indicates error code 30, but this is not a malfunction. Turn the key to "OFF" and then to "ON" to clear the error code. Failing to do so will prevent the engine from starting even though the engine will crank when pushing the start switch.
  - an engine auto-stop system. The engine stops automatically if left idling for 20 minutes. In this case, the multi-function meter unit indicates error code 70, but this is not a malfunction. Push the start switch to clear the error code and to restart the engine.
- 

## **Starting the engine**

In order for the ignition circuit cut-off system to enable starting, one of the following conditions must be met.

- The transmission is in the neutral position.
- The transmission is in gear with the clutch lever pulled and the sidestand up.

See page 3-22 for more information.

1. Turn the key to "ON" and make sure that the engine stop switch is set to "○".

The following warning lights and indicator light should come on for a few seconds, then go off.

- Oil level warning light
- Coolant temperature warning light
- Engine trouble warning light
- ABS warning light (for ABS models)
- Immobilizer system indicator light

# OPERATION AND IMPORTANT RIDING POINTS

ECA11833

## NOTICE

If a warning or indicator light does not come on initially when the key is turned to “ON”, or if a warning or indicator light remains on, see page 3-4 for the corresponding warning and indicator light circuit check.

2. Shift the transmission into the neutral position. The neutral indicator light should come on. If not, ask a Yamaha dealer to check the electrical circuit.
3. Start the engine by pushing the start switch.  
If the engine fails to start, release the start switch, wait a few seconds, and then try again. Each starting attempt should be as short as possible to preserve the battery. Do not crank the engine more than 10 seconds on any one attempt.

ECA11042

## NOTICE

For maximum engine life, never accelerate hard when the engine is cold!

EAU16671

## Shifting

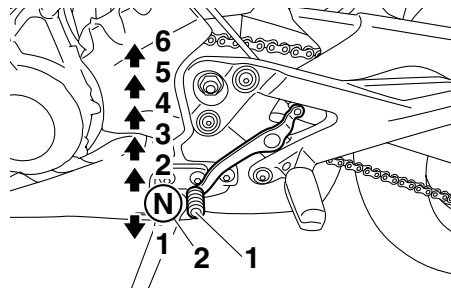

1. Shift pedal
2. Neutral position

Shifting gears lets you control the amount of engine power available for starting off, accelerating, climbing hills, etc.

The gear positions are shown in the illustration.

## TIP

To shift the transmission into the neutral position, press the shift pedal repeatedly until it reaches the end of its travel, and then slightly raise it.

ECA10260

## NOTICE

- Even with the transmission in the neutral position, do not coast for long periods of time with the engine off, and do not tow the motorcycle for long distances. The transmission is properly lubricated only when the engine is running. Inadequate lubrication may damage the transmission.
- Always use the clutch while changing gears to avoid damaging the engine, transmission, and drive train, which are not designed to withstand the shock of forced shifting.

# OPERATION AND IMPORTANT RIDING POINTS

---

## Tips for reducing fuel consumption

EAU16810

Fuel consumption depends largely on your riding style. Consider the following tips to reduce fuel consumption:

- Shift up swiftly, and avoid high engine speeds during acceleration.
- Do not rev the engine while shifting down, and avoid high engine speeds with no load on the engine.
- Turn the engine off instead of letting it idle for an extended length of time (e.g., in traffic jams, at traffic lights or at railroad crossings).

## Engine break-in

EAU16841

There is never a more important period in the life of your engine than the period between 0 and 1600 km (1000 mi). For this reason, you should read the following material carefully.

Since the engine is brand new, do not put an excessive load on it for the first 1600 km (1000 mi). The various parts in the engine wear and polish themselves to the correct operating clearances. During this period, prolonged full-throttle operation or any condition that might result in engine overheating must be avoided.

EAU17093

### 0–1000 km (0–600 mi)

Avoid prolonged operation above 5800 r/min. **NOTICE: After 1000 km (600 mi) of operation, the engine oil must be changed and the oil filter cartridge or element replaced.** [ECA10302]

### 1000–1600 km (600–1000 mi)

Avoid prolonged operation above 7000 r/min.

## 1600 km (1000 mi) and beyond

The vehicle can now be operated normally.

ECA10310

### NOTICE

---

- Keep the engine speed out of the tachometer red zone.
  - If any engine trouble should occur during the engine break-in period, immediately have a Yamaha dealer check the vehicle.
-

EAU17213

## Parking

When parking, stop the engine, and then remove the key from the main switch.

EWA10311

### **WARNING**

- Since the engine and exhaust system can become very hot, park in a place where pedestrians or children are not likely to touch them and be burned.
  - Do not park on a slope or on soft ground, otherwise the vehicle may overturn, increasing the risk of a fuel leak and fire.
  - Do not park near grass or other flammable materials which might catch fire.
-

# PERIODIC MAINTENANCE AND ADJUSTMENT

---

EAU17243

EWA15121

EAU17302

Periodic inspection, adjustment, and lubrication will keep your vehicle in the safest and most efficient condition possible. Safety is an obligation of the vehicle owner/operator. The most important points of vehicle inspection, adjustment, and lubrication are explained on the following pages.

The intervals given in the periodic maintenance charts should be simply considered as a general guide under normal riding conditions. However, depending on the weather, terrain, geographical location, and individual use, the maintenance intervals may need to be shortened.

## WARNING

EWA10321

**Failure to properly maintain the vehicle or performing maintenance activities incorrectly may increase your risk of injury or death during service or while using the vehicle. If you are not familiar with vehicle service, have a Yamaha dealer perform service.**

---

## WARNING

**Turn off the engine when performing maintenance unless otherwise specified.**

- **A running engine has moving parts that can catch on body parts or clothing and electrical parts that can cause shocks or fires.**
- **Running the engine while servicing can lead to eye injury, burns, fire, or carbon monoxide poisoning – possibly leading to death. See page 1-1 for more information about carbon monoxide.**

EWA15460

## WARNING

**Brake discs, calipers, drums, and linings can become very hot during use. To avoid possible burns, let brake components cool before touching them.**

---

Emission controls not only function to ensure cleaner air, but are also vital to proper engine operation and maximum performance. In the following periodic maintenance charts, the services related to emissions control are grouped separately. These services require specialized data, knowledge, and equipment. Maintenance, replacement, or repair of the emission control devices and systems may be performed by any repair establishment or individual that is certified (if applicable). Yamaha dealers are trained and equipped to perform these particular services.

EAU39691

## Owner's tool kit

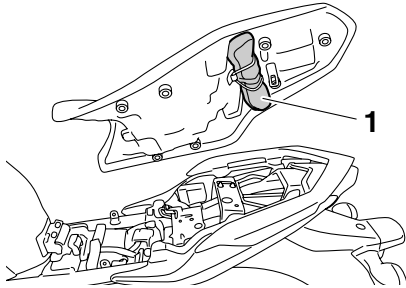

1. Owner's tool kit

The owner's tool kit is located on the bottom of the seat. (See page 3-18.)

The service information included in this manual and the tools provided in the owner's tool kit are intended to assist you in the performance of preventive maintenance and minor repairs. However, additional tools such as a torque wrench may be necessary to perform certain maintenance work correctly.

### **TIP** \_\_\_\_\_

If you do not have the tools or experience required for a particular job, have a Yamaha dealer perform it for you.

# PERIODIC MAINTENANCE AND ADJUSTMENT

EAU46861

## TIP

- The annual checks must be performed every year, except if a kilometer-based maintenance, or for the UK, a mileage-based maintenance, is performed instead.
- From 50000 km (30000 mi), repeat the maintenance intervals starting from 10000 km (6000 mi).
- Items marked with an asterisk should be performed by a Yamaha dealer as they require special tools, data and technical skills.

EAU46910

## Periodic maintenance chart for the emission control system

NO.	ITEM	CHECK OR MAINTENANCE JOB	ODOMETER READING					ANNUAL CHECK
			1000 km (600 mi)	10000 km (6000 mi)	20000 km (12000 mi)	30000 km (18000 mi)	40000 km (24000 mi)	
1	* Fuel line	<ul style="list-style-type: none"> <li>• Check fuel hoses for cracks or damage.</li> </ul>		√	√	√	√	√
2	* Spark plugs	<ul style="list-style-type: none"> <li>• Check condition.</li> <li>• Clean and regap.</li> </ul>		√		√		
		<ul style="list-style-type: none"> <li>• Replace.</li> </ul>			√		√	
3	* Valves	<ul style="list-style-type: none"> <li>• Check valve clearance.</li> <li>• Adjust.</li> </ul>	Every 40000 km (24000 mi)					
4	* Fuel injection	<ul style="list-style-type: none"> <li>• Adjust engine idling speed and synchronization.</li> </ul>	√	√	√	√	√	√
5	* Air induction system	<ul style="list-style-type: none"> <li>• Check the air cut-off valve, reed valve, and hose for damage.</li> <li>• Replace the entire air induction system if necessary.</li> </ul>		√	√	√	√	√

6



# PERIODIC MAINTENANCE AND ADJUSTMENT

EAU1770C

## General maintenance and lubrication chart

NO.	ITEM	CHECK OR MAINTENANCE JOB	ODOMETER READING					ANNUAL CHECK
			1000 km (600 mi)	10000 km (6000 mi)	20000 km (12000 mi)	30000 km (18000 mi)	40000 km (24000 mi)	
1	<b>Air filter element</b>	<ul style="list-style-type: none"> <li>• Replace.</li> </ul>					√	
2	<b>Clutch</b>	<ul style="list-style-type: none"> <li>• Check operation.</li> <li>• Adjust.</li> </ul>	√	√	√	√	√	
3	* <b>Front brake</b>	<ul style="list-style-type: none"> <li>• Check operation, fluid level and vehicle for fluid leakage.</li> </ul>	√	√	√	√	√	√
		<ul style="list-style-type: none"> <li>• Replace brake pads.</li> </ul>	Whenever worn to the limit					
4	* <b>Rear brake</b>	<ul style="list-style-type: none"> <li>• Check operation, fluid level and vehicle for fluid leakage.</li> </ul>	√	√	√	√	√	√
		<ul style="list-style-type: none"> <li>• Replace brake pads.</li> </ul>	Whenever worn to the limit					
5	* <b>Brake hoses</b>	<ul style="list-style-type: none"> <li>• Check for cracks or damage.</li> </ul>		√	√	√	√	√
		<ul style="list-style-type: none"> <li>• Replace.</li> </ul>	Every 4 years					
6	* <b>Wheels</b>	<ul style="list-style-type: none"> <li>• Check runout and for damage.</li> </ul>		√	√	√	√	
7	* <b>Tires</b>	<ul style="list-style-type: none"> <li>• Check tread depth and for damage.</li> <li>• Replace if necessary.</li> <li>• Check air pressure.</li> <li>• Correct if necessary.</li> </ul>		√	√	√	√	√
8	* <b>Wheel bearings</b>	<ul style="list-style-type: none"> <li>• Check bearing for looseness or damage.</li> </ul>		√	√	√	√	
9	* <b>Swingarm</b>	<ul style="list-style-type: none"> <li>• Check operation and for excessive play.</li> </ul>		√	√	√	√	
		<ul style="list-style-type: none"> <li>• Lubricate with lithium-soap-based grease.</li> </ul>	Every 50000 km (30000 mi)					

# PERIODIC MAINTENANCE AND ADJUSTMENT

NO.	ITEM	CHECK OR MAINTENANCE JOB	ODOMETER READING					ANNUAL CHECK
			1000 km (600 mi)	10000 km (6000 mi)	20000 km (12000 mi)	30000 km (18000 mi)	40000 km (24000 mi)	
10	Drive chain	<ul style="list-style-type: none"> <li>• Check chain slack, alignment and condition.</li> <li>• Adjust and lubricate chain with a special O-ring chain lubricant thoroughly.</li> </ul>	Every 1000 km (600 mi) and after washing the motorcycle, riding in the rain or riding in wet areas					
11	* Steering bearings	<ul style="list-style-type: none"> <li>• Check bearing play and steering for roughness.</li> <li>• Lubricate with lithium-soap-based grease.</li> </ul>	√	√	√	√	√	
12	* Chassis fasteners	<ul style="list-style-type: none"> <li>• Make sure that all nuts, bolts and screws are properly tightened.</li> </ul>		√	√	√	√	√
13	Brake lever pivot shaft	<ul style="list-style-type: none"> <li>• Lubricate with silicone grease.</li> </ul>		√	√	√	√	√
14	Brake pedal pivot shaft	<ul style="list-style-type: none"> <li>• Lubricate with lithium-soap-based grease.</li> </ul>		√	√	√	√	√
15	Clutch lever pivot shaft	<ul style="list-style-type: none"> <li>• Lubricate with lithium-soap-based grease.</li> </ul>		√	√	√	√	√
16	Shift pedal pivot shaft	<ul style="list-style-type: none"> <li>• Lubricate with lithium-soap-based grease.</li> </ul>		√	√	√	√	√
17	Sidestand	<ul style="list-style-type: none"> <li>• Check operation.</li> <li>• Lubricate with lithium-soap-based grease.</li> </ul>		√	√	√	√	√
18	* Sidestand switch	<ul style="list-style-type: none"> <li>• Check operation.</li> </ul>	√	√	√	√	√	√
19	* Front fork	<ul style="list-style-type: none"> <li>• Check operation and for oil leakage.</li> </ul>		√	√	√	√	
20	* Shock absorber assembly	<ul style="list-style-type: none"> <li>• Check operation and shock absorber for oil leakage.</li> </ul>		√	√	√	√	

# PERIODIC MAINTENANCE AND ADJUSTMENT

NO.	ITEM	CHECK OR MAINTENANCE JOB	ODOMETER READING					ANNUAL CHECK
			1000 km (600 mi)	10000 km (6000 mi)	20000 km (12000 mi)	30000 km (18000 mi)	40000 km (24000 mi)	
21	Engine oil	<ul style="list-style-type: none"> <li>• Change.</li> <li>• Check oil level and vehicle for oil leakage.</li> </ul>	√	√	√	√	√	√
22	Engine oil filter cartridge	<ul style="list-style-type: none"> <li>• Replace.</li> </ul>	√		√		√	
23	* Cooling system	<ul style="list-style-type: none"> <li>• Check coolant level and vehicle for coolant leakage.</li> </ul>		√	√	√	√	√
		<ul style="list-style-type: none"> <li>• Change.</li> </ul>	Every 3 years					
24	* Front and rear brake switches	<ul style="list-style-type: none"> <li>• Check operation.</li> </ul>	√	√	√	√	√	√
25	Moving parts and cables	<ul style="list-style-type: none"> <li>• Lubricate.</li> </ul>		√	√	√	√	√
26	* Throttle grip	<ul style="list-style-type: none"> <li>• Check operation.</li> <li>• Check throttle grip free play, and adjust if necessary.</li> <li>• Lubricate cable and grip housing.</li> </ul>		√	√	√	√	√
27	* Lights, signals and switches	<ul style="list-style-type: none"> <li>• Check operation.</li> <li>• Adjust headlight beam.</li> </ul>	√	√	√	√	√	√

EAU18680

## TIP

- Air filter
  - This model's air filter is equipped with a disposable oil-coated paper element, which must not be cleaned with compressed air to avoid damaging it.
  - The air filter element needs to be replaced more frequently when riding in unusually wet or dusty areas.

# PERIODIC MAINTENANCE AND ADJUSTMENT

---

---

- Hydraulic brake service
    - Regularly check and, if necessary, correct the brake fluid level.
    - Every two years replace the internal components of the brake master cylinders and calipers, and change the brake fluid.
    - Replace the brake hoses every four years and if cracked or damaged.
-

# PERIODIC MAINTENANCE AND ADJUSTMENT

## Removing and installing the cowling and panels

EAU18722

The cowling and panels shown need to be removed to perform some of the maintenance jobs described in this chapter. Refer to this section each time the cowling or a panel needs to be removed and installed.

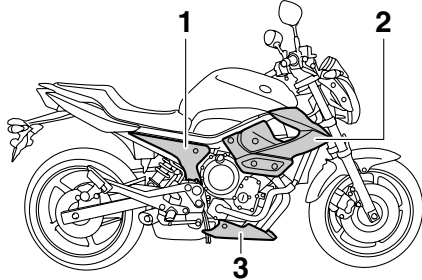

1. Panel A
2. Panel B
3. Cowling A

### Cowling A

EAU46740

#### To remove the cowling

Remove the bolts, and then take the cowling off.

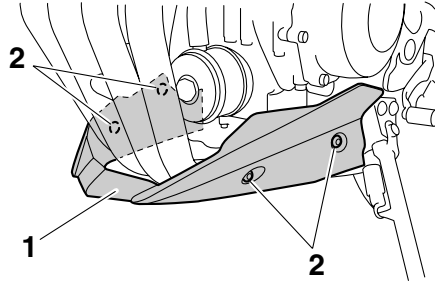

1. Cowling A
2. Bolt

#### To install the cowling

Place the cowling in the original position, and then install the bolts.

### Panel A

EAU46770

#### To remove the panel

Remove the bolt and the quick fastener, and then take the panel off.

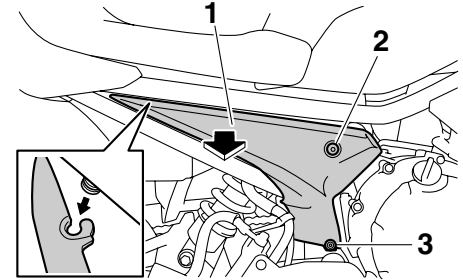

1. Panel A
2. Bolt
3. Quick fastener

#### To install the panel

Place the panel in the original position, and then install the bolt and the quick fastener.

### Panel B

EAU19193

#### To remove the panel

Remove the bolts, and then take the panel off.

# PERIODIC MAINTENANCE AND ADJUSTMENT

EAU19642

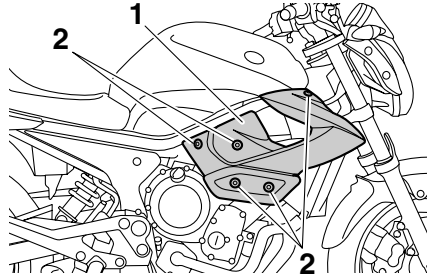

1. Panel B
2. Bolt

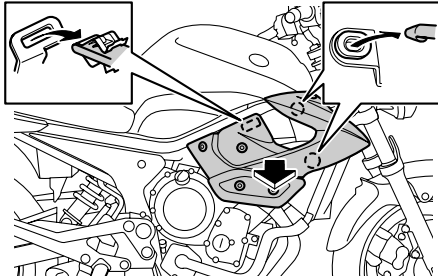
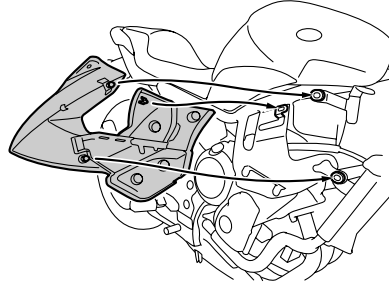

6

## To install the panel

Place the panel in the original position, and then install the bolts.

## Checking the spark plugs

The spark plugs are important engine components, which should be checked periodically, preferably by a Yamaha dealer. Since heat and deposits will cause any spark plug to slowly erode, they should be removed and checked in accordance with the periodic maintenance and lubrication chart. In addition, the condition of the spark plugs can reveal the condition of the engine.

The porcelain insulator around the center electrode of each spark plug should be a medium-to-light tan (the ideal color when the vehicle is ridden normally), and all spark plugs installed in the engine should have the same color. If any spark plug shows a distinctly different color, the engine could be operating improperly. Do not attempt to diagnose such problems yourself. Instead, have a Yamaha dealer check the vehicle.

If a spark plug shows signs of electrode erosion and excessive carbon or other deposits, it should be replaced.

**Specified spark plug:**  
NGK/CR9E

# PERIODIC MAINTENANCE AND ADJUSTMENT

EAU46721

Before installing a spark plug, the spark plug gap should be measured with a wire thickness gauge and, if necessary, adjusted to specification.

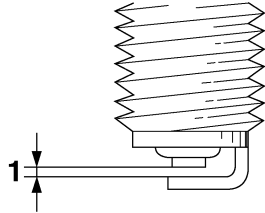

1. Spark plug gap

## Spark plug gap:

0.7–0.8 mm (0.028–0.031 in)

Clean the surface of the spark plug gasket and its mating surface, and then wipe off any grime from the spark plug threads.

## Tightening torque:

Spark plug:  
13 Nm (1.3 m·kgf, 9.4 ft·lbf)

## TIP

If a torque wrench is not available when installing a spark plug, a good estimate of the correct torque is 1/4–1/2 turn past finger tight. However, the spark plug should be tightened to the specified torque as soon as possible.

## Engine oil and oil filter cartridge

The engine oil level should be checked before each ride. In addition, the oil must be changed and the oil filter cartridge replaced at the intervals specified in the periodic maintenance and lubrication chart.

## To check the engine oil level

1. Place the vehicle on a level surface and hold it in an upright position. A slight tilt to the side can result in a false reading.
2. Start the engine, warm it up for several minutes, and then turn it off.
3. Wait a few minutes until the oil settles.
4. Remove the engine oil dipstick and wipe it clean, insert it back into the hole (without screwing it in), and then remove it again to check the oil level.

## TIP

The engine oil should be between the minimum and maximum level marks.

# PERIODIC MAINTENANCE AND ADJUSTMENT

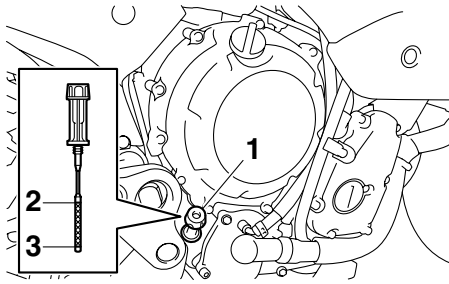

1. Engine oil dipstick
2. Maximum level mark
3. Minimum level mark

5. If the engine oil is at or below the minimum level mark, remove the oil filler cap, and then add sufficient oil of the recommended type to raise it to the correct level.

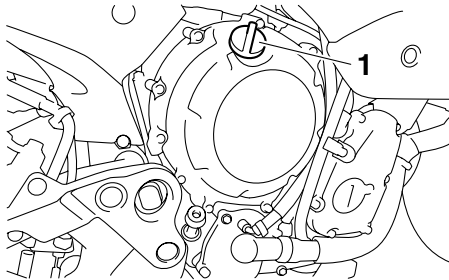

1. Engine oil filler cap

6. Insert and tighten the engine oil dipstick, and then install and tighten the oil filler cap.

## To change the engine oil (with or without oil filter cartridge replacement)

1. Remove cowling A. (See page 6-8.)
2. Start the engine, warm it up for several minutes, and then turn it off.
3. Place an oil pan under the engine to collect the used oil.
4. Remove the engine oil filler cap, the engine oil drain bolt and its gasket to drain the oil from the crankcase.

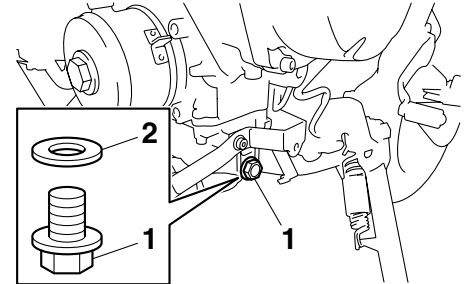

1. Engine oil drain bolt
2. Gasket

## TIP

Skip steps 5–7 if the oil filter cartridge is not being replaced.

5. Remove the oil filter cartridge with an oil filter wrench.

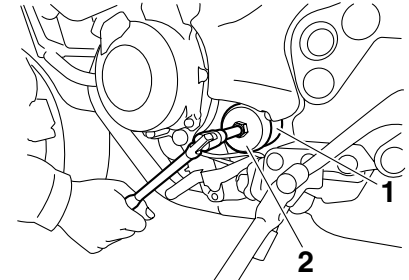

1. Oil filter cartridge
2. Oil filter wrench



# PERIODIC MAINTENANCE AND ADJUSTMENT

**TIP** \_\_\_\_\_  
An oil filter wrench is available at a Yamaha dealer.

6. Apply a thin coat of clean engine oil to the O-ring of the new oil filter cartridge.

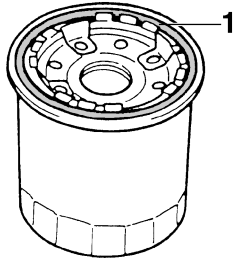

1. O-ring

**TIP** \_\_\_\_\_  
Make sure that the O-ring is properly seated.

7. Install the new oil filter cartridge with an oil filter wrench, and then tighten it to the specified torque with a torque wrench.

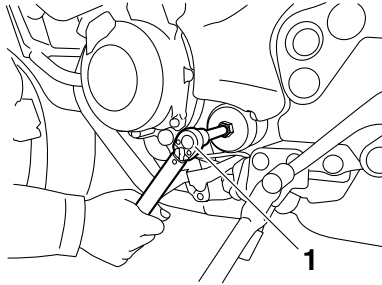

1. Torque wrench

**Tightening torque:**  
Oil filter cartridge:  
17 Nm (1.7 m·kgf, 12 ft·lbf)

8. Install the engine oil drain bolt and its new gasket, and then tighten the bolt to the specified torque.

**Tightening torque:**  
Engine oil drain bolt:  
43 Nm (4.3 m·kgf, 31 ft·lbf)

9. Refill with the specified amount of the recommended engine oil, and then install and tighten the oil filler cap.

## Recommended engine oil:

See page 8-1.

## Oil quantity:

Without oil filter cartridge replacement:

2.50 L (2.64 US qt, 2.20 Imp.qt)

With oil filter cartridge replacement:

2.80 L (2.96 US qt, 2.46 Imp.qt)

**TIP** \_\_\_\_\_  
Be sure to wipe off spilled oil on any parts after the engine and exhaust system have cooled down.

ECA11620

## NOTICE

- In order to prevent clutch slippage (since the engine oil also lubricates the clutch), do not mix any chemical additives. Do not use oils with a diesel specification of "CD" or oils of a higher quality than specified. In addition, do not use oils labeled "ENERGY CONSERVING II" or higher.
- Make sure that no foreign material enters the crankcase.

# PERIODIC MAINTENANCE AND ADJUSTMENT

10. Start the engine, and then let it idle for several minutes while checking it for oil leakage. If oil is leaking, immediately turn the engine off and check for the cause.

## TIP \_\_\_\_\_

After the engine is started, the engine oil level warning light should go off if the oil level is sufficient.

ECA10401

## NOTICE \_\_\_\_\_

**If the oil level warning light flickers or remains on even if the oil level is correct, immediately turn the engine off and have a Yamaha dealer check the vehicle.**

11. Turn the engine off, wait a few minutes until the oil settles, and then check the oil level and correct it if necessary.
12. Install the cowling.

## Coolant

EAU20070

The coolant level should be checked before each ride. In addition, the coolant must be changed at the intervals specified in the periodic maintenance and lubrication chart.

## To check the coolant level

EAU46801

1. Place the vehicle on a level surface and hold it in an upright position.

## TIP \_\_\_\_\_

- The coolant level must be checked on a cold engine since the level varies with engine temperature.
- Make sure that the vehicle is positioned straight up when checking the coolant level. A slight tilt to the side can result in a false reading.

2. Check the coolant level in the coolant reservoir.

## TIP \_\_\_\_\_

The coolant should be between the minimum and maximum level marks.

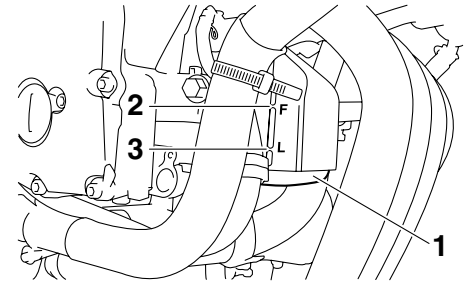

1. Coolant reservoir
2. Maximum level mark
3. Minimum level mark

3. If the coolant is at or below the minimum level mark, remove the coolant reservoir breather hose from the guide, and then remove the coolant reservoir cap.

# PERIODIC MAINTENANCE AND ADJUSTMENT

EAU46822

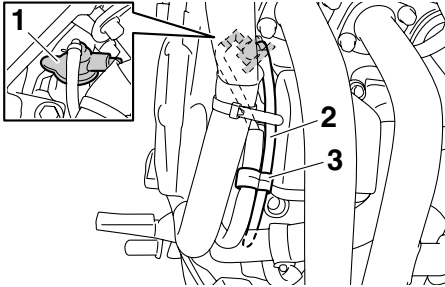

1. Coolant reservoir cap
2. Coolant reservoir breather hose
3. Guide

4. Add coolant to the maximum level mark, and then install the coolant reservoir cap. **WARNING! Remove only the coolant reservoir cap. Never attempt to remove the radiator cap when the engine is hot.** [EWA15161] **NOTICE: If coolant is not available, use distilled water or soft tap water instead. Do not use hard water or salt water since it is harmful to the engine. If water has been used instead of coolant, replace it with coolant as soon as possible, otherwise the cooling system will not be protected**

**against frost and corrosion. If water has been added to the coolant, have a Yamaha dealer check the antifreeze content of the coolant as soon as possible, otherwise the effectiveness of the coolant will be reduced.**

[ECA10472]

**Coolant reservoir capacity (up to the maximum level mark):**  
0.25 L (0.26 US qt, 0.22 Imp.qt)

5. Route the coolant reservoir breather hose through the guide as shown.

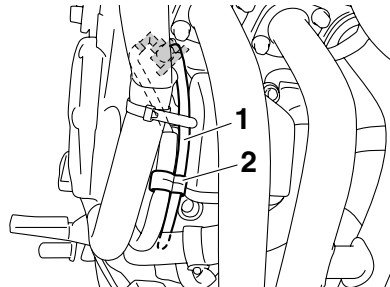

1. Coolant reservoir breather hose
2. Guide

## To change the coolant

1. Place the vehicle on a level surface and let the engine cool if necessary.
2. Remove cowling A and panel B. (See page 6-8.)
3. Place a container under the engine to collect the used coolant.
4. Remove the radiator cap retaining bolt, radiator cap retainer and radiator cap. **WARNING! Never attempt to remove the radiator cap when the engine is hot.**

[EWA10381]

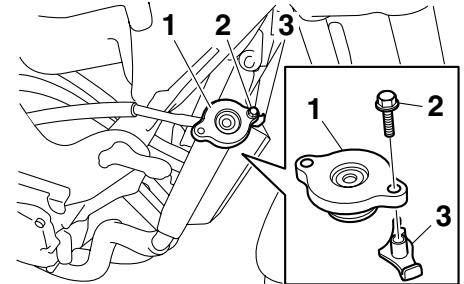

1. Radiator cap
2. Radiator cap retaining bolt
3. Radiator cap retainer

# PERIODIC MAINTENANCE AND ADJUSTMENT

5. Remove the coolant reservoir breather hose from the guide, and then remove the coolant reservoir cap.

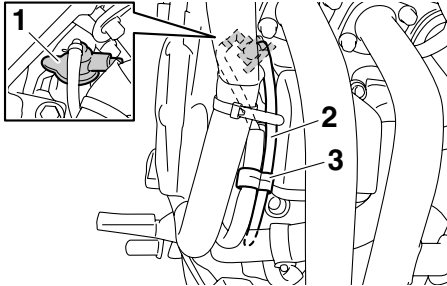

1. Coolant reservoir cap
2. Coolant reservoir breather hose
3. Guide

6. Remove the coolant reservoir cover and coolant reservoir by removing the bolts.

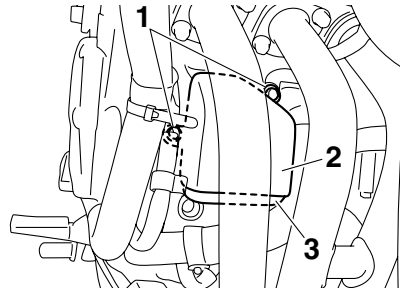

1. Bolt
2. Coolant reservoir cover
3. Coolant reservoir

7. Drain the coolant from the coolant reservoir by turning it upside down.
8. Remove the coolant drain bolt and its gasket to drain the cooling system.

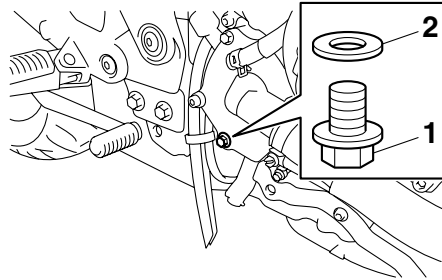

1. Coolant drain bolt
2. Gasket

9. After the coolant is completely drained, thoroughly flush the cooling system with clean tap water.
10. Install the coolant drain bolt and its new gasket, and then tighten the bolt to the specified torque.

## Tightening torque:

Coolant drain bolt:  
10 Nm (1.0 m·kgf, 7.2 ft·lbf)

11. Install the coolant reservoir and its cover by placing them in the original position, and then installing the bolts.
12. Pour the specified amount of the recommended coolant into the radiator and reservoir.

# PERIODIC MAINTENANCE AND ADJUSTMENT

## Antifreeze/water mixture ratio:

1:1

## Recommended antifreeze:

High-quality ethylene glycol antifreeze containing corrosion inhibitors for aluminum engines

## Coolant quantity:

Radiator capacity (including all routes):

2.00 L (2.11 US qt, 1.76 Imp.qt)

Coolant reservoir capacity (up to the maximum level mark):

0.25 L (0.26 US qt, 0.22 Imp.qt)

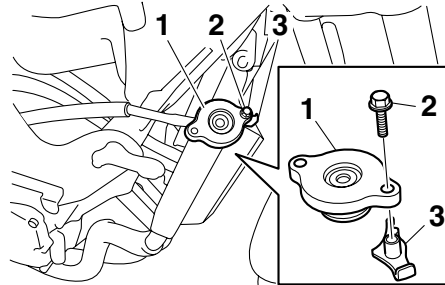

1. Radiator cap
2. Radiator cap retaining bolt
3. Radiator cap retainer

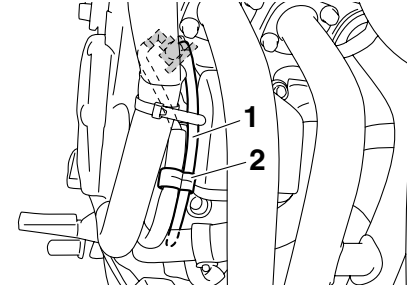

1. Coolant reservoir breather hose
2. Guide

13. Install the radiator cap.
14. Install the coolant reservoir cap.
15. Start the engine, let it idle for several minutes, and then turn it off.
16. Remove the radiator cap to check the coolant level in the radiator. If necessary, add sufficient coolant until it reaches the top of the radiator, and then install the radiator cap, radiator cap retainer and radiator cap retaining bolt.

17. Check the coolant level in the reservoir. If necessary, remove the coolant reservoir cap, add coolant to the maximum level mark, and then install the cap.
18. Route the coolant reservoir breather hose through the guide as shown.

19. Start the engine, and then check the vehicle for coolant leakage. If coolant is leaking, have a Yamaha dealer check the cooling system.
20. Install the cowlings and the panel.

# PERIODIC MAINTENANCE AND ADJUSTMENT

EAU34425

## Replacing the air filter element

The air filter element should be replaced at the intervals specified in the periodic maintenance and lubrication chart. Replace the air filter element more frequently if you are riding in unusually wet or dusty areas.

1. Remove the seat. (See page 3-18.)
2. Remove the fuel tank bolts, and then lift the fuel tank away from the air filter case.

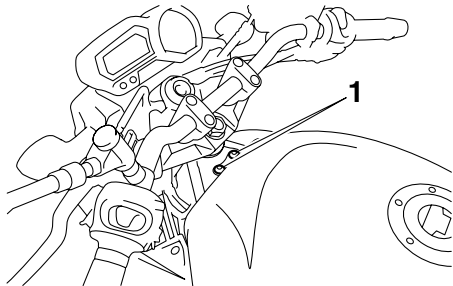

1. Fuel tank bolt

3. Remove the air filter case cover by removing the screws. **NOTICE:** When removing the air filter

case cover, be careful not to allow foreign objects to drop into the air intake manifold. [ECA12881]

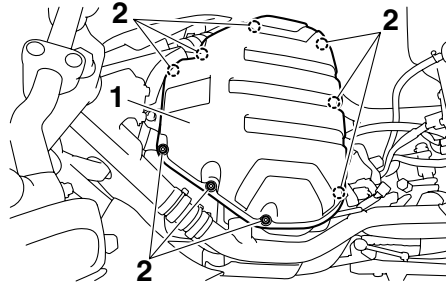

1. Air filter case cover  
2. Screw

4. Pull the air filter element out.

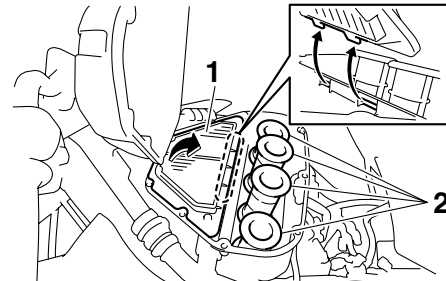

1. Air filter element  
2. Air intake manifold

5. Insert a new air filter element into the air filter case. **NOTICE:** Make sure that the air filter element is properly seated in the air filter case. The engine should never be operated without the air filter element installed, otherwise the piston(s) and/or cylinder(s) may become excessively worn.

[ECA10481]

6. Install the air filter case cover by installing the screws.
7. Place the fuel tank in its original position. Make sure that the fuel hoses are properly connected and routed, and are not pinched. Be sure to place the hoses in their original position. **WARNING!** Before placing the fuel tank in the original position, make sure that all hoses (i.e., fuel hose, fuel tank breather hose, fuel tank overflow hose) are not damaged, that they are properly connected and routed, and that they are not pinched. If any hose is damaged, have a Yamaha dealer replace the hose before starting

# PERIODIC MAINTENANCE AND ADJUSTMENT

the engine, otherwise fuel may leak, creating a fire hazard.

[EWA12463]

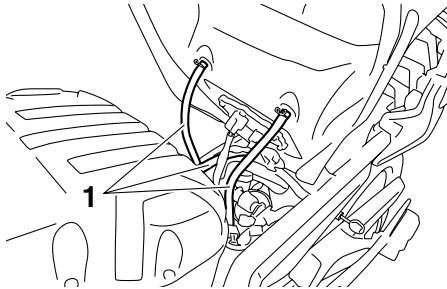

1. Hose

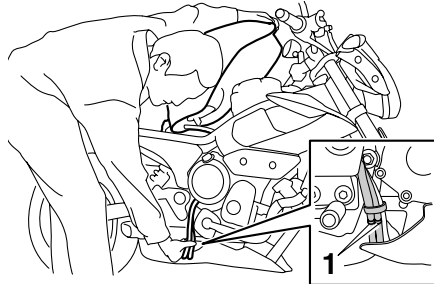

1. Original position (paint mark)

8. Install the fuel tank bolts.
9. Install the seat.

## Adjusting the engine idling speed

EAU34301

The engine idling speed must be checked and, if necessary, adjusted as follows at the intervals specified in the periodic maintenance and lubrication chart.

The engine should be warm before making this adjustment.

Check the engine idling speed and, if necessary, adjust it to specification by turning the idle adjusting screw. To increase the engine idling speed, turn the screw in direction (a). To decrease the engine idling speed, turn the screw in direction (b).

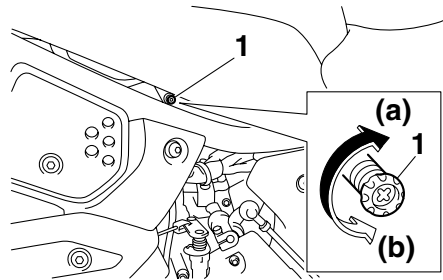

1. Idle adjusting screw

**Engine idling speed:**  
1250–1350 r/min

### TIP

If the specified idling speed cannot be obtained as described above, have a Yamaha dealer make the adjustment.

# PERIODIC MAINTENANCE AND ADJUSTMENT

## Checking the throttle grip free play

EAU21384

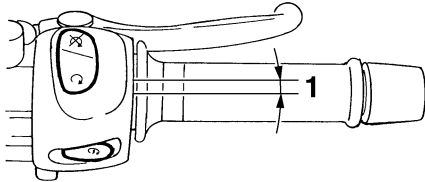

### 1. Throttle grip free play

The throttle grip free play should measure 3.0–5.0 mm (0.12–0.20 in) at the inner edge of the throttle grip. Periodically check the throttle grip free play and, if necessary, have a Yamaha dealer adjust it.

6

## Valve clearance

EAU21401

The valve clearance changes with use, resulting in improper air-fuel mixture and/or engine noise. To prevent this from occurring, the valve clearance must be adjusted by a Yamaha dealer at the intervals specified in the periodic maintenance and lubrication chart.

## Tires

EAU21774

To maximize the performance, durability, and safe operation of your motorcycle, note the following points regarding the specified tires.

### Tire air pressure

The tire air pressure should be checked and, if necessary, adjusted before each ride.

EWA10503

### **⚠ WARNING**

**Operation of this vehicle with improper tire pressure may cause severe injury or death from loss of control.**

- **The tire air pressure must be checked and adjusted on cold tires (i.e., when the temperature of the tires equals the ambient temperature).**
- **The tire air pressure must be adjusted in accordance with the riding speed and with the total weight of rider, passenger, cargo, and accessories approved for this model.**



# PERIODIC MAINTENANCE AND ADJUSTMENT

EWA10471

## Tire air pressure (measured on cold tires):

### 0–90 kg (0–198 lb):

Front:

225 kPa (2.25 kgf/cm<sup>2</sup>, 33 psi)

Rear:

250 kPa (2.50 kgf/cm<sup>2</sup>, 36 psi)

### XJ6N 90–195 kg (198–430 lb)

### XJ6NA 90–190 kg (198–419 lb):

Front:

250 kPa (2.50 kgf/cm<sup>2</sup>, 36 psi)

Rear:

290 kPa (2.90 kgf/cm<sup>2</sup>, 42 psi)

### High-speed riding:

Front:

225 kPa (2.25 kgf/cm<sup>2</sup>, 33 psi)

Rear:

250 kPa (2.50 kgf/cm<sup>2</sup>, 36 psi)

### Maximum load\*:

XJ6N 195 kg (430 lb)

XJ6NA 190 kg (419 lb)

\* Total weight of rider, passenger, cargo and accessories

EWA10511



**WARNING**

**Never overload your vehicle. Operation of an overloaded vehicle could cause an accident.**

## Tire inspection

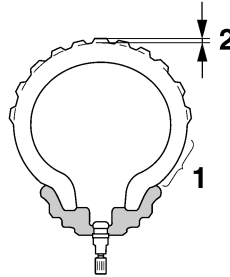

1. Tire sidewall
2. Tire tread depth

The tires must be checked before each ride. If the center tread depth reaches the specified limit, if the tire has a nail or glass fragments in it, or if the sidewall is cracked, have a Yamaha dealer replace the tire immediately.

**Minimum tire tread depth (front and rear):**  
1.6 mm (0.06 in)

## TIP

The tire tread depth limits may differ from country to country. Always comply with the local regulations.



**WARNING**

- Have a Yamaha dealer replace excessively worn tires. Besides being illegal, operating the vehicle with excessively worn tires decreases riding stability and can lead to loss of control.
- The replacement of all wheel and brake-related parts, including the tires, should be left to a Yamaha dealer, who has the necessary professional knowledge and experience to do so.
- Ride at moderate speeds after changing a tire since the tire surface must first be “broken in” for it to develop its optimal characteristics.

# PERIODIC MAINTENANCE AND ADJUSTMENT

EWA10600

## Tire information

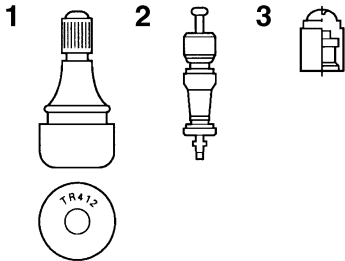

1. Tire air valve
2. Tire air valve core
3. Tire air valve cap with seal

This motorcycle is equipped with cast wheels and tubeless tires with valves.

EWA10481

### **WARNING**

- The front and rear tires should be of the same make and design, otherwise the handling characteristics of the motorcycle may be different, which could lead to an accident.
- Always make sure that the valve caps are securely installed to prevent air pressure leakage.

- Use only the tire valves and valve cores listed below to avoid tire deflation during a high-speed ride.

After extensive tests, only the tires listed below have been approved for this model by Yamaha Motor Co., Ltd.

#### Front tire:

Size:  
120/70 ZR17M/C (58W)  
Manufacturer/model:  
BRIDGESTONE/BT021  
DUNLOP/ROADSMART

#### Rear tire:

Size:  
160/60 ZR17M/C (69W)  
Manufacturer/model:  
BRIDGESTONE/BT021  
DUNLOP/ROADSMART

#### FRONT and REAR:

Tire air valve:  
TR412  
Valve core:  
#9100 (original)

### **WARNING**

This motorcycle is fitted with super-high-speed tires. Note the following points in order to make the most efficient use of these tires.

- Use only the specified replacement tires. Other tires may run the danger of bursting at super high speeds.
- Brand-new tires can have a relatively poor grip on certain road surfaces until they have been “broken in”. Therefore, it is advisable before doing any high-speed riding to ride conservatively for approximately 100 km (60 mi) after installing a new tire.
- The tires must be warmed up before a high-speed run.
- Always adjust the tire air pressure according to the operating conditions.

# PERIODIC MAINTENANCE AND ADJUSTMENT

## Cast wheels

To maximize the performance, durability, and safe operation of your vehicle, note the following points regarding the specified wheels.

- The wheel rims should be checked for cracks, bends, warpage or other damage before each ride. If any damage is found, have a Yamaha dealer replace the wheel. Do not attempt even the smallest repair to the wheel. A deformed or cracked wheel must be replaced.
- The wheel should be balanced whenever either the tire or wheel has been changed or replaced. An unbalanced wheel can result in poor performance, adverse handling characteristics, and a shortened tire life.

EAU21962

## Adjusting the clutch lever free play

EAU46730

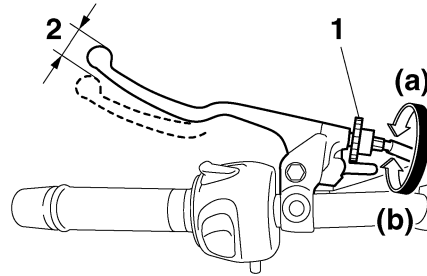

1. Clutch lever free play adjusting bolt
2. Clutch lever free play

The clutch lever free play should measure 10.0–15.0 mm (0.39–0.59 in) as shown. Periodically check the clutch lever free play and, if necessary, adjust it as follows.

To increase the clutch lever free play, turn the clutch lever free play adjusting bolt at the clutch lever in direction (a). To decrease the clutch lever free play, turn the adjusting bolt in direction (b).

## TIP \_\_\_\_\_

If the specified clutch lever free play cannot be obtained as described above, proceed as follows.

1. Fully turn the adjusting bolt at the clutch lever in direction (a) to loosen the clutch cable.
2. Loosen the locknut further down the clutch cable.
3. To increase the clutch lever free play, turn the clutch lever free play adjusting nut in direction (a). To decrease the clutch lever free play, turn the adjusting nut in direction (b).

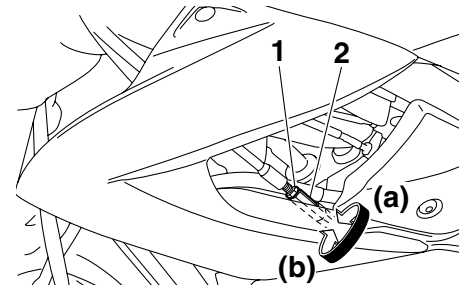

1. Locknut (clutch cable)
2. Clutch lever free play adjusting nut (clutch cable)

# PERIODIC MAINTENANCE AND ADJUSTMENT

---

4. Tighten the locknut.

## Checking the brake lever free play

EAU37913

braking performance, which may result in loss of control and an accident.

---

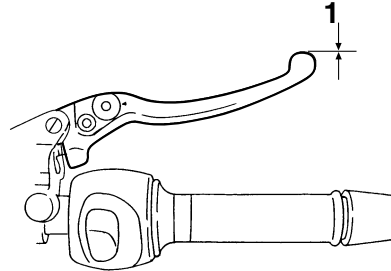

1. No brake lever free play

There should be no free play at the brake lever end. If there is free play, have a Yamaha dealer inspect the brake system.

EWA14211

### **WARNING**

**A soft or spongy feeling in the brake lever can indicate the presence of air in the hydraulic system. If there is air in the hydraulic system, have a Yamaha dealer bleed the system before operating the vehicle. Air in the hydraulic system will diminish the**

# PERIODIC MAINTENANCE AND ADJUSTMENT

## Brake light switches (for ABS models)

EAU50750

The brake light, which is activated by the brake pedal and brake lever, should come on just before braking takes effect. If necessary, have a Yamaha dealer adjust the brake light switches.

## Brake light switches (for non-ABS models)

EAU50760

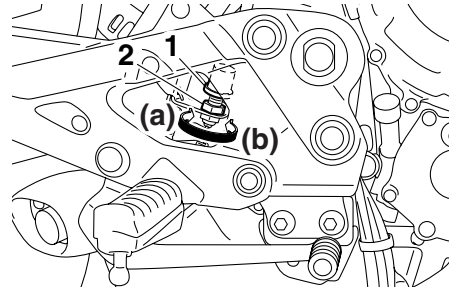

1. Rear brake light switch
2. Rear brake light switch adjusting nut

The brake light, which is activated by the brake pedal and brake lever, should come on just before braking takes effect. If necessary, adjust the rear brake light switch as follows, but the front brake light switch should be adjusted by a Yamaha dealer.

Turn the rear brake light switch adjusting nut while holding the rear brake light switch in place. To make the brake light come on earlier, turn the adjusting nut in direction (a). To make the brake light come on later, turn the adjusting nut in direction (b).

## Checking the front and rear brake pads

EAU22392

The front and rear brake pads must be checked for wear at the intervals specified in the periodic maintenance and lubrication chart.

### Front brake pads

EAU22420

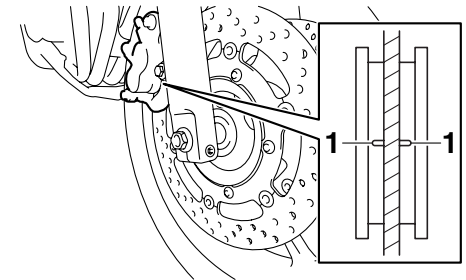

1. Brake pad wear indicator groove

Each front brake pad is provided with a wear indicator groove, which allows you to check the brake pad wear without having to disassemble the brake. To check the brake pad wear, check the wear indicator groove. If a brake pad has worn to the point that the wear

# PERIODIC MAINTENANCE AND ADJUSTMENT

indicator groove has almost disappeared, have a Yamaha dealer replace the brake pads as a set.

## Rear brake pads

EAU22500

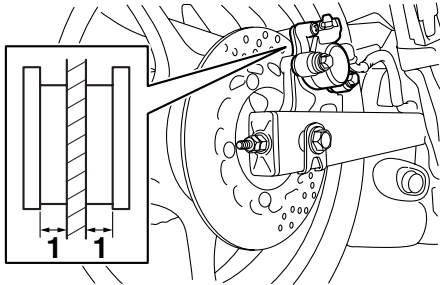

1. Lining thickness

Check each rear brake pad for damage and measure the lining thickness. If a brake pad is damaged or if the lining thickness is less than 1.5 mm (0.06 in), have a Yamaha dealer replace the brake pads as a set.

## Checking the brake fluid level

EAU39371

### Front brake

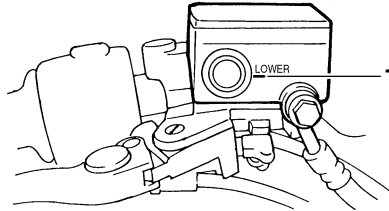

1. Minimum level mark

### Rear brake

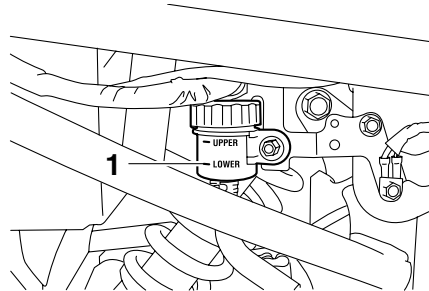

1. Minimum level mark

Insufficient brake fluid may allow air to enter the brake system, possibly causing it to become ineffective.

Before riding, check that the brake fluid is above the minimum level mark and replenish if necessary. A low brake fluid level may indicate worn brake pads and/or brake system leakage. If the brake fluid level is low, be sure to check the brake pads for wear and the brake system for leakage.

### TIP

The rear brake fluid reservoir is located behind panel A. (See page 6-8.)

Observe these precautions:

- When checking the fluid level, make sure that the top of the brake fluid reservoir is level.
- Use only the recommended quality brake fluid, otherwise the rubber seals may deteriorate, causing leakage and poor braking performance.

**Recommended brake fluid:**  
DOT 4

- Refill with the same type of brake fluid. Mixing fluids may result in a harmful chemical reaction and lead to poor braking performance.

# PERIODIC MAINTENANCE AND ADJUSTMENT

- Be careful that water does not enter the brake fluid reservoir when refilling. Water will significantly lower the boiling point of the fluid and may result in vapor lock.
- Brake fluid may deteriorate painted surfaces or plastic parts. Always clean up spilled fluid immediately.
- As the brake pads wear, it is normal for the brake fluid level to gradually go down. However, if the brake fluid level goes down suddenly, have a Yamaha dealer check the cause.

## Changing the brake fluid

EAU22731

Have a Yamaha dealer change the brake fluid at the intervals specified in the TIP after the periodic maintenance and lubrication chart. In addition, have the oil seals of the master cylinders and calipers as well as the brake hoses replaced at the intervals listed below or whenever they are damaged or leaking.

- Oil seals: Replace every two years.
- Brake hoses: Replace every four years.

## Drive chain slack

EAU22760

The drive chain slack should be checked before each ride and adjusted if necessary.

### To check the drive chain slack

EAU22773

1. Place the motorcycle on the side-stand.

### TIP

When checking and adjusting the drive chain slack, there should be no weight on the motorcycle.

2. Shift the transmission into the neutral position.
3. Move the rear wheel by pushing the motorcycle to locate the tightest portion of the drive chain, and then measure the drive chain slack as shown.

#### Drive chain slack:

45.0–55.0 mm (1.77–2.17 in)

# PERIODIC MAINTENANCE AND ADJUSTMENT

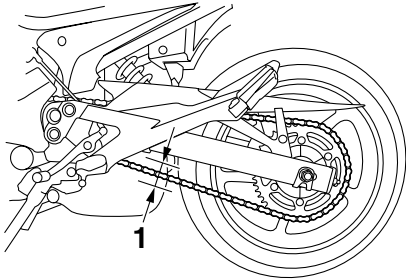

1. Drive chain slack

4. If the drive chain slack is incorrect, adjust it as follows.

EAU47032

6

## To adjust the drive chain slack

1. Loosen the locknut at each end of the swingarm, and then loosen the axle nut.
2. To tighten the drive chain, turn the drive chain slack adjusting nut at each end of the swingarm in direction (a). To loosen the drive chain, turn the adjusting nut at each end of the swingarm in direction (b), and then push the rear wheel forward. **NOTICE: Improper drive chain slack will overload the engine as well as other vital parts**

of the motorcycle and can lead to chain slippage or breakage. To prevent this from occurring, keep the drive chain slack within the specified limits. [ECA10571]

### TIP

Using the alignment marks on each side of the swingarm, make sure that the notch on the alignment plates is in the same position on both sides for proper wheel alignment.

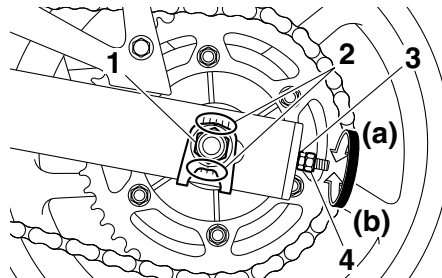

1. Axle nut
2. Alignment marks
3. Drive chain slack adjusting nut
4. Locknut

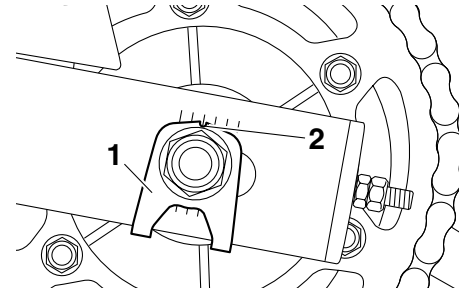

1. Alignment plate
2. Notch

3. Tighten the axle nut, and then tighten the locknuts to the specified torques.

### Tightening torques:

- Axle nut:  
90 Nm (9.0 m·kgf, 65 ft·lbf)
- Locknut:  
16 Nm (1.6 m·kgf, 12 ft·lbf)



# PERIODIC MAINTENANCE AND ADJUSTMENT

## Cleaning and lubricating the drive chain

EAU23025

The drive chain must be cleaned and lubricated at the intervals specified in the periodic maintenance and lubrication chart, otherwise it will quickly wear out, especially when riding in dusty or wet areas. Service the drive chain as follows.

ECA10583

### **NOTICE**

**The drive chain must be lubricated after washing the motorcycle, riding in the rain or riding in wet areas.**

1. Clean the drive chain with kerosene and a small soft brush.  
**NOTICE: To prevent damaging the O-rings, do not clean the drive chain with steam cleaners, high-pressure washers or inappropriate solvents.** [ECA11121]
2. Wipe the drive chain dry.
3. Thoroughly lubricate the drive chain with a special O-ring chain lubricant. **NOTICE: Do not use engine oil or any other lubricants for the drive chain, as they**

may contain substances that could damage the O-rings.

[ECA11111]

## Checking and lubricating the cables

EAU23094

The operation of all control cables and the condition of the cables should be checked before each ride, and the cables and cable ends should be lubricated if necessary. If a cable is damaged or does not move smoothly, have a Yamaha dealer check or replace it. **WARNING! Damage to the outer housing of cables may result in internal rusting and cause interference with cable movement. Replace damaged cables as soon as possible to prevent unsafe conditions.**

[EWA10711]

### **Recommended lubricant:**

Yamaha Chain and Cable Lube or 4-stroke engine oil

# PERIODIC MAINTENANCE AND ADJUSTMENT

## Checking and lubricating the throttle grip and cable

EAU49920

The operation of the throttle grip should be checked before each ride. In addition, the cable should be lubricated by a Yamaha dealer at the intervals specified in the periodic maintenance chart.

## Checking and lubricating the brake and shift pedals

EAU44272

**Recommended lubricant:**  
Lithium-soap-based grease

### Brake pedal

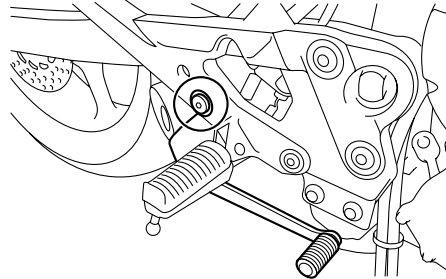

### Shift pedal

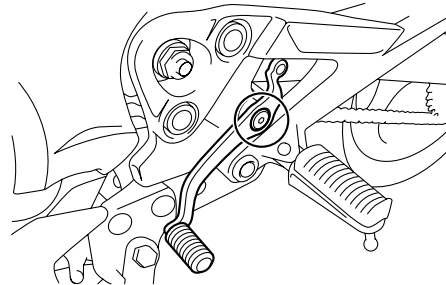

The operation of the brake and shift pedals should be checked before each ride, and the pedal pivots should be lubricated if necessary.

# PERIODIC MAINTENANCE AND ADJUSTMENT

## Checking and lubricating the brake and clutch levers

EAU23142

### Brake lever

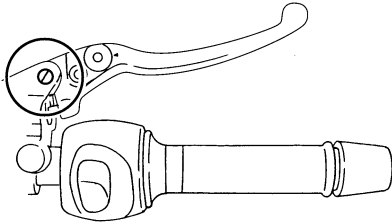

### Clutch lever

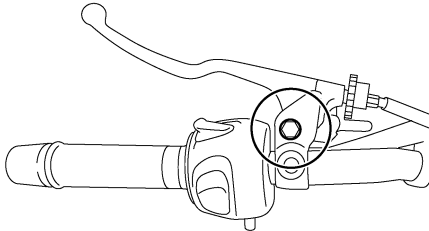

The operation of the brake and clutch levers should be checked before each ride, and the lever pivots should be lubricated if necessary.

### Recommended lubricants:

- Brake lever:  
Silicone grease
- Clutch lever:  
Lithium-soap-based grease

## Checking and lubricating the sidestand

EAU23202

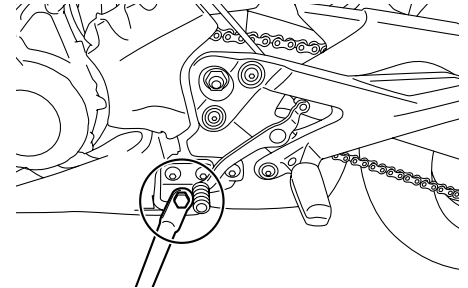

The operation of the sidestand should be checked before each ride, and the sidestand pivot and metal-to-metal contact surfaces should be lubricated if necessary.

EWA10731

### **⚠ WARNING**

**If the sidestand does not move up and down smoothly, have a Yamaha dealer check or repair it. Otherwise, the sidestand could contact the ground and distract the operator, resulting in a possible loss of control.**

### Recommended lubricant:

Lithium-soap-based grease

# PERIODIC MAINTENANCE AND ADJUSTMENT

## Lubricating the swingarm pivots

EAUM1651

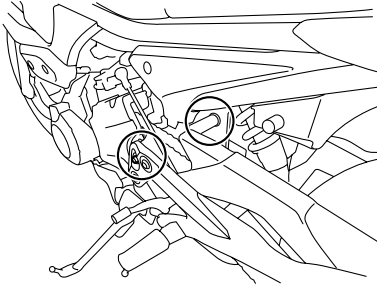

The swingarm pivots must be lubricated by a Yamaha dealer at the intervals specified in the periodic maintenance and lubrication chart.

**Recommended lubricant:**  
Lithium-soap-based grease

## Checking the front fork

EAU23272

The condition and operation of the front fork must be checked as follows at the intervals specified in the periodic maintenance and lubrication chart.

### To check the condition

Check the inner tubes for scratches, damage and excessive oil leakage.

### To check the operation

1. Place the vehicle on a level surface and hold it in an upright position. **WARNING! To avoid injury, securely support the vehicle so there is no danger of it falling over.** [EWA10751]
2. While applying the front brake, push down hard on the handlebars several times to check if the front fork compresses and rebounds smoothly.

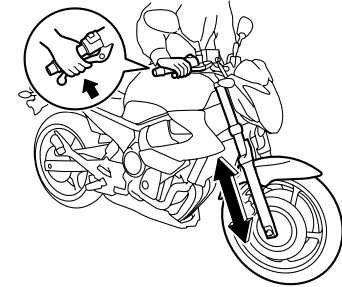

ECA10590

### **NOTICE**

**If any damage is found or the front fork does not operate smoothly, have a Yamaha dealer check or repair it.**

# PERIODIC MAINTENANCE AND ADJUSTMENT

EAU23283

## Checking the steering

Worn or loose steering bearings may cause danger. Therefore, the operation of the steering must be checked as follows at the intervals specified in the periodic maintenance and lubrication chart.

1. Place a stand under the engine to raise the front wheel off the ground. (See page 6-40 for more information.) **WARNING! To avoid injury, securely support the vehicle so there is no danger of it falling over.** [EWA10751]
2. Hold the lower ends of the front fork legs and try to move them forward and backward. If any free play can be felt, have a Yamaha dealer check or repair the steering.

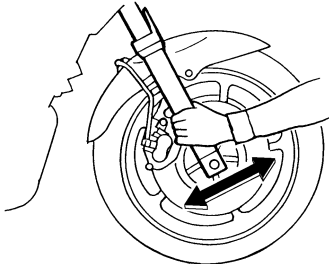

EAU23291

## Checking the wheel bearings

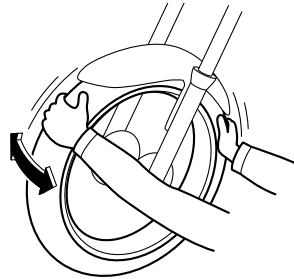

The front and rear wheel bearings must be checked at the intervals specified in the periodic maintenance and lubrication chart. If there is play in the wheel hub or if the wheel does not turn smoothly, have a Yamaha dealer check the wheel bearings.

EAU50290

## Battery

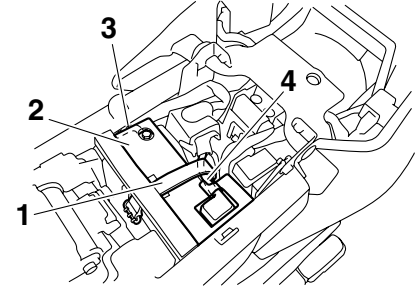

1. Battery band
2. Battery cover
3. Negative battery lead (black)
4. Positive battery lead (red)

The battery is located under the seat. (See page 3-18.)

This model is equipped with a VRLA (Valve Regulated Lead Acid) battery. There is no need to check the electrolyte or to add distilled water. However, the battery lead connections need to be checked and, if necessary, tightened.

EWA10760

### **WARNING**

- **Electrolyte is poisonous and dangerous since it contains sulfuric acid, which causes severe**

# PERIODIC MAINTENANCE AND ADJUSTMENT

---

burns. Avoid any contact with skin, eyes or clothing and always shield your eyes when working near batteries. In case of contact, administer the following FIRST AID.

- **EXTERNAL:** Flush with plenty of water.
  - **INTERNAL:** Drink large quantities of water or milk and immediately call a physician.
  - **EYES:** Flush with water for 15 minutes and seek prompt medical attention.
  - Batteries produce explosive hydrogen gas. Therefore, keep sparks, flames, cigarettes, etc., away from the battery and provide sufficient ventilation when charging it in an enclosed space.
  - **KEEP THIS AND ALL BATTERIES OUT OF THE REACH OF CHILDREN.**
- 

## To charge the battery

Have a Yamaha dealer charge the battery as soon as possible if it seems to have discharged. Keep in mind that the

battery tends to discharge more quickly if the vehicle is equipped with optional electrical accessories.

ECA16521

### **NOTICE**

---

To charge a VRLA (Valve Regulated Lead Acid) battery, a special (constant-voltage) battery charger is required. Using a conventional battery charger will damage the battery.

---

## To store the battery

1. If the vehicle will not be used for more than one month, remove the battery, fully charge it, and then place it in a cool, dry place. **NOTICE:** When removing the battery, be sure the key is turned to “OFF”, then disconnect the negative lead before disconnecting the positive lead.
2. If the battery will be stored for more than two months, check it at least once a month and fully charge it if necessary.
3. Fully charge the battery before installation. **NOTICE:** When installing the battery, be sure the key

[ECA16302]

is turned to “OFF”, then connect the positive lead before connecting the negative lead.

[ECA16840]

4. After installation, make sure that the battery leads are properly connected to the battery terminals.

ECA16530

### **NOTICE**

---

Always keep the battery charged. Storing a discharged battery can cause permanent battery damage.

---

# PERIODIC MAINTENANCE AND ADJUSTMENT

EAU47172

## Replacing the fuses

The main fuse and the fuse boxes, which contain the fuses for the individual circuits, are located under the seat. (See page 3-18.)

### TIP

To access the main fuse, remove the starter relay cover as shown.

### XJ6N

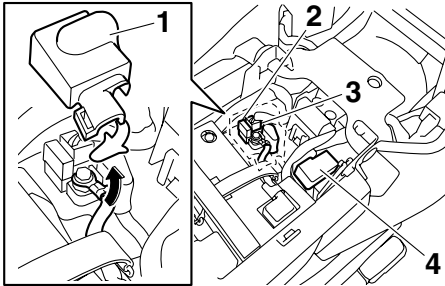

1. Starter relay cover
2. Main fuse
3. Spare main fuse
4. Fuse box

### XJ6N

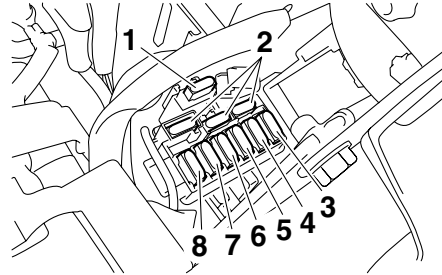

1. Taillight fuse
2. Spare fuse
3. Headlight fuse
4. Ignition fuse
5. Signaling system fuse
6. Backup fuse (for clock and immobilizer system)
7. Fuel injection system fuse
8. Radiator fan fuse

### XJ6NA

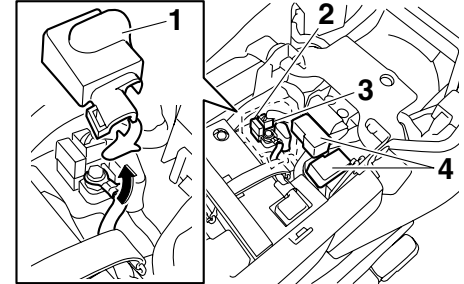

1. Starter relay cover
2. Main fuse
3. Spare main fuse
4. Fuse box

# PERIODIC MAINTENANCE AND ADJUSTMENT

## XJ6NA

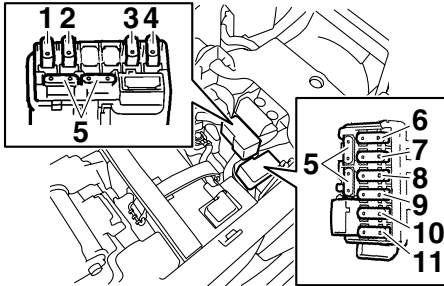

1. Taillight fuse
2. ABS control unit fuse
3. ABS solenoid fuse
4. ABS motor fuse
5. Spare fuse
6. Headlight fuse
7. Ignition fuse
8. Signaling system fuse
9. Backup fuse (for clock and immobilizer system)
10. Fuel injection system fuse
11. Radiator fan fuse

If a fuse is blown, replace it as follows.

1. Turn the key to "OFF" and turn off the electrical circuit in question.
2. Remove the blown fuse, and then install a new fuse of the specified amperage. **WARNING! Do not use a fuse of a higher amperage**

rating than recommended to avoid causing extensive damage to the electrical system and possibly a fire. [EWA15131]

4. If the fuse immediately blows again, have a Yamaha dealer check the electrical system.

### Specified fuses:

- Main fuse:  
30.0 A
- Headlight fuse:  
20.0 A
- Taillight fuse:  
10.0 A
- Signaling system fuse:  
7.5 A
- Ignition fuse:  
10.0 A
- Radiator fan fuse:  
20.0 A
- Fuel injection system fuse:  
10.0 A
- Backup fuse:  
7.5 A
- ABS motor fuse:  
XJ6NA 30.0 A
- ABS control unit fuse:  
XJ6NA 7.5 A
- ABS solenoid fuse:  
XJ6NA 20.0 A

3. Turn the key to "ON" and turn on the electrical circuit in question to check if the device operates.



# PERIODIC MAINTENANCE AND ADJUSTMENT

## Replacing the headlight bulb

EAU46811

This model is equipped with a quartz bulb headlight. If the headlight bulb burns out, replace it as follows.

ECA10650

### NOTICE

Take care not to damage the following parts:

- **Headlight bulb**

Do not touch the glass part of the headlight bulb to keep it free from oil, otherwise the transparency of the glass, the luminosity of the bulb, and the bulb life will be adversely affected. Thoroughly clean off any dirt and fingerprints on the headlight bulb using a cloth moistened with alcohol or thinner.

- **Headlight lens**

Do not affix any type of tinted film or stickers to the headlight lens.

Do not use a headlight bulb of a wattage higher than specified.

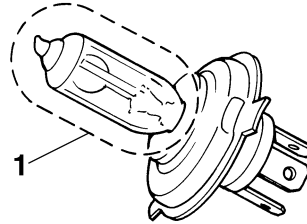

1. Do not touch the glass part of the bulb.

1. Remove the headlight unit side covers by removing the bolts on each side.

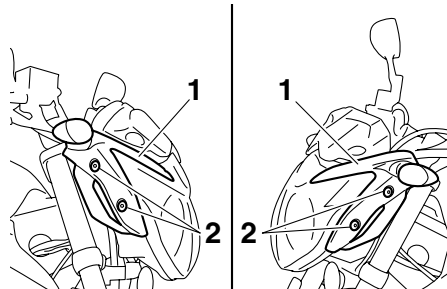

1. Headlight unit side cover
2. Bolt

2. Remove the multi-function meter unit bolts, and then lift up the meter to unhook its projections from the slots in the meter stay.

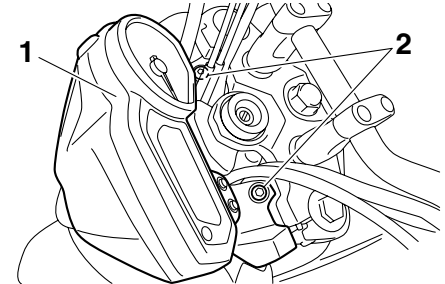

1. Multi-function meter unit
2. Bolt

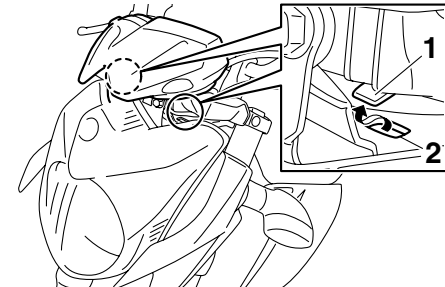

1. Projection
2. Slot

# PERIODIC MAINTENANCE AND ADJUSTMENT

3. Remove the headlight unit by removing the bolts.

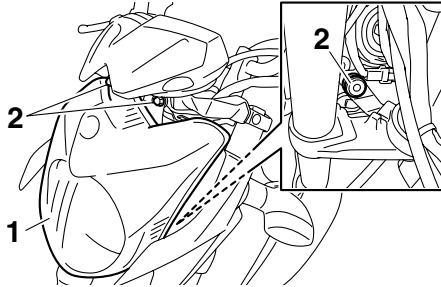

1. Headlight unit
2. Bolt

4. Disconnect the headlight coupler, and then remove the headlight bulb cover.

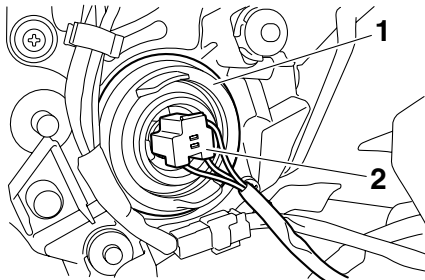

1. Headlight bulb cover
2. Headlight coupler

5. Unhook the headlight bulb holder, and then remove the burnt-out bulb.

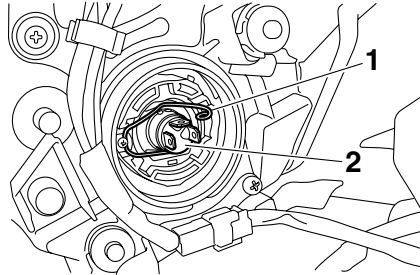

1. Headlight bulb holder
2. Headlight bulb

6. Place a new headlight bulb into position, and then secure it with the bulb holder.
7. Install the headlight bulb cover, and then connect the coupler.
8. Fit the projection on the headlight meter unit into the grommet in the headlight stay, and then install the headlight unit by installing the bolts.

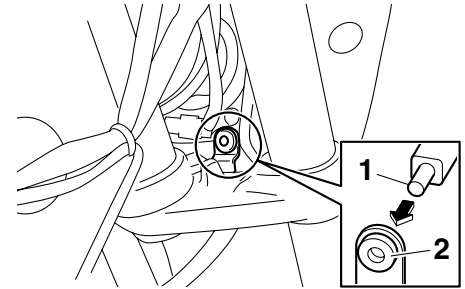

1. Projection
2. Grommet

9. Fit the projections on the multi-function meter unit into the slots in the meter stay, place the meter in the original position, and then install the bolts.

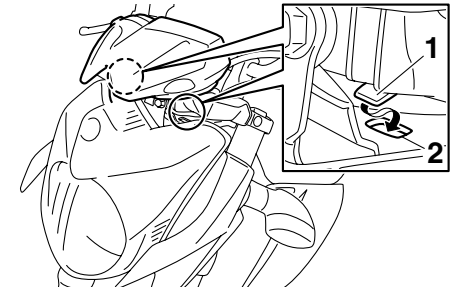

1. Projection
2. Slot

# PERIODIC MAINTENANCE AND ADJUSTMENT

10. Place the headlight unit side covers in their original position, and then install the bolts.

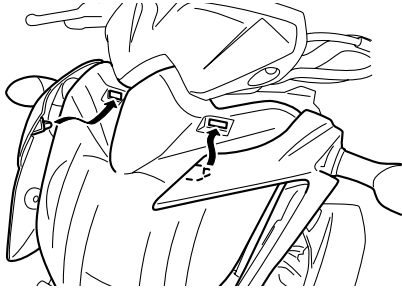

11. Have a Yamaha dealer adjust the headlight beam if necessary.

## Replacing the tail/brake light bulb

EAU47021

1. Remove the seat. (See page 3-18.)
2. Remove the tail/brake light bulb socket (together with the bulb) by turning it counterclockwise.

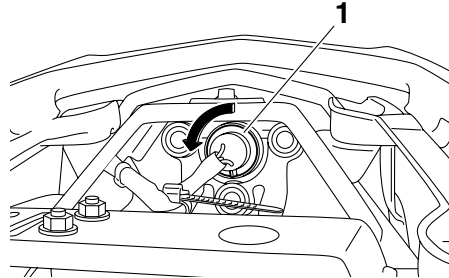

1. Tail/brake light bulb socket

3. Remove the burnt-out bulb by pulling it out.

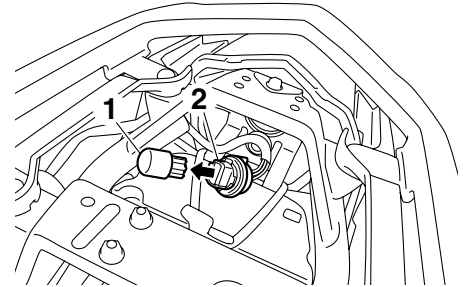

1. Tail/brake light bulb  
2. Tail/brake light bulb socket

4. Insert a new bulb into the socket.
5. Install the socket (together with the bulb) by turning it clockwise.
6. Install the seat.

# PERIODIC MAINTENANCE AND ADJUSTMENT

EAU24204

## Replacing a turn signal light bulb

1. Remove the turn signal light lens by removing the screw.

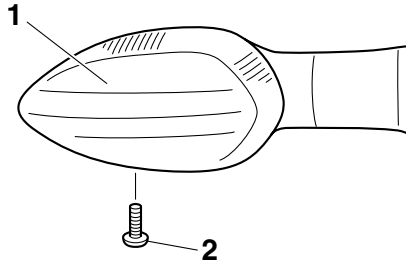

1. Turn signal light lens
2. Screw

2. Remove the burnt-out bulb by pushing it in and turning it counter-clockwise.
3. Insert a new bulb into the socket, push it in, and then turn it clockwise until it stops.
4. Install the lens by installing the screw. **NOTICE: Do not over-tighten the screw, otherwise the lens may break.** [ECA11191]

EAU24313

## Replacing the license plate light bulb

1. Remove the license plate light unit by removing the screws.

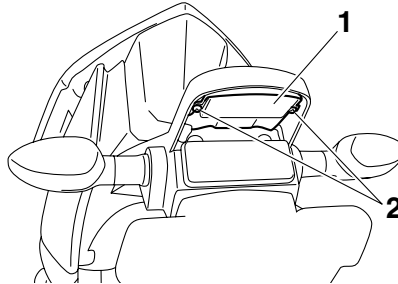

1. License plate light unit
2. Screw

2. Remove the license plate light bulb socket (together with the bulb) by pulling it out.

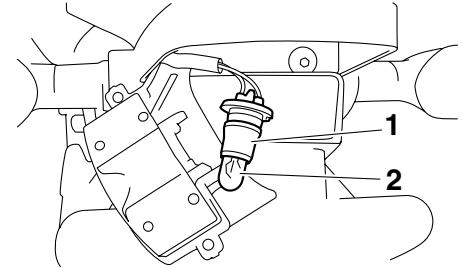

1. License plate light bulb socket
2. License plate light bulb

3. Remove the burnt-out bulb by pulling it out.
4. Insert a new bulb into the socket.
5. Install the socket (together with the bulb) by pushing it in.
6. Install the license plate light unit by installing the screws.

# PERIODIC MAINTENANCE AND ADJUSTMENT

EAU42873

## Replacing the auxiliary light bulb

If the auxiliary light bulb burns out, replace it as follows.

1. Remove the headlight unit. (See page 6-36.)
2. Remove the auxiliary light bulb socket (together with the coupler and bulb) by turning the socket counterclockwise.

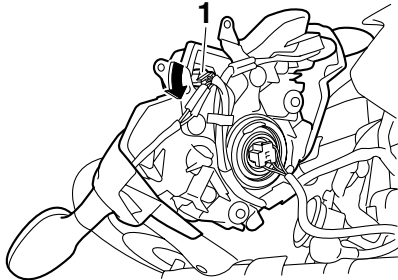

1. Auxiliary light bulb socket

3. Remove the burnt-out bulb by pulling it out.

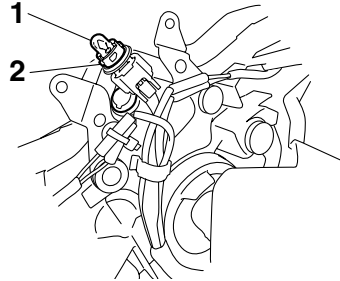

1. Auxiliary light bulb  
2. Auxiliary light bulb socket

4. Insert a new bulb into the socket.
5. Install the socket (together with the coupler and bulb) by pushing it in and turning it clockwise.
6. Install the headlight unit.

EAU24350

## Supporting the motorcycle

Since this model is not equipped with a centerstand, follow these precautions when removing the front and rear wheel or performing other maintenance requiring the motorcycle to stand upright. Check that the motorcycle is in a stable and level position before starting any maintenance. A strong wooden box can be placed under the engine for added stability.

### To service the front wheel

1. Stabilize the rear of the motorcycle by using a motorcycle stand or, if an additional motorcycle stand is not available, by placing a jack under the frame in front of the rear wheel.
2. Raise the front wheel off the ground by using a motorcycle stand.

### To service the rear wheel

Raise the rear wheel off the ground by using a motorcycle stand or, if a motorcycle stand is not available, by placing

# PERIODIC MAINTENANCE AND ADJUSTMENT

a jack either under each side of the frame in front of the rear wheel or under each side of the swingarm.

## Front wheel (for non-ABS models)

EAU44791

### **WARNING**

EWA14840

**For the ABS model, have a Yamaha dealer remove and install the wheel.**

## To remove the front wheel

EAU24491

### **WARNING**

EWA10821

**To avoid injury, securely support the vehicle so there is no danger of it falling over.**

1. Loosen the front wheel axle pinch bolt, then the wheel axle and the brake caliper bolts.

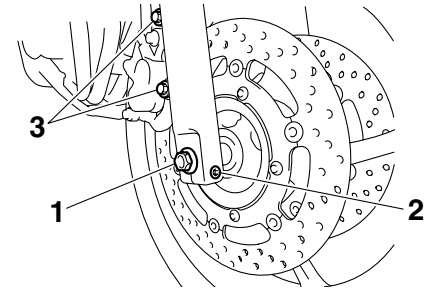

1. Wheel axle
  2. Front wheel axle pinch bolt
  3. Brake caliper bolt
2. Lift the front wheel off the ground according to the procedure on page 6-40.
  3. Remove the brake caliper on each side by removing the bolts.  
**NOTICE: Do not apply the brake after the brake calipers have been removed, otherwise the brake pads will be forced shut.**

[ECA11051]

# PERIODIC MAINTENANCE AND ADJUSTMENT

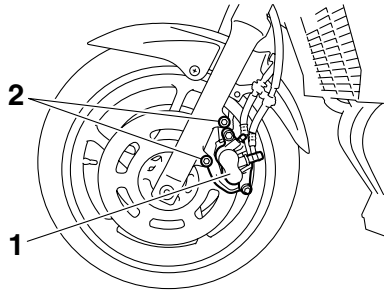

1. Brake caliper
2. Brake caliper bolt

4. Pull the wheel axle out, and then remove the wheel.

## To install the front wheel

EAU43371

1. Lift the wheel up between the fork legs.
2. Insert the wheel axle.
3. Install the brake calipers by installing the bolts.

## TIP

Make sure that there is enough space between the brake pads before installing the brake calipers onto the brake discs.

4. Lower the front wheel so that it is on the ground, and then put the sidestand down.
5. Tighten the wheel axle, the front wheel axle pinch bolt and the brake caliper bolts to the specified torques.

### Tightening torques:

Wheel axle:

65 Nm (6.5 m·kgf, 47 ft·lbf)

Front wheel axle pinch bolt:

19 Nm (1.9 m·kgf, 14 ft·lbf)

Brake caliper bolt:

40 Nm (4.0 m·kgf, 29 ft·lbf)

6. Push down hard on the handlebar several times to check for proper fork operation.

## Rear wheel (for non-ABS models)

EAU44801

EWA14840

### WARNING

For the ABS model, have a Yamaha dealer remove and install the wheel.

EAU34414

## To remove the rear wheel

EWA10821

### WARNING

To avoid injury, securely support the vehicle so there is no danger of it falling over.

1. Loosen the locknut and drive chain slack adjusting nut on each side of the swingarm.
2. Loosen the axle nut.

# PERIODIC MAINTENANCE AND ADJUSTMENT

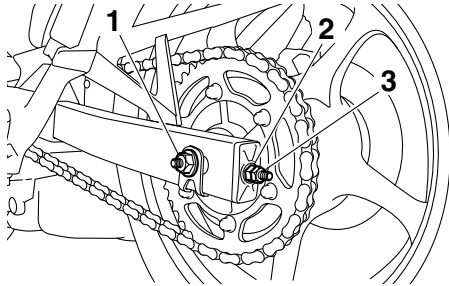

1. Axle nut
2. Drive chain slack adjusting nut
3. Locknut

3. Lift the rear wheel off the ground according to the procedure on page 6-40.
4. Remove the axle nut.
5. Push the wheel forward, and then remove the drive chain from the rear sprocket.

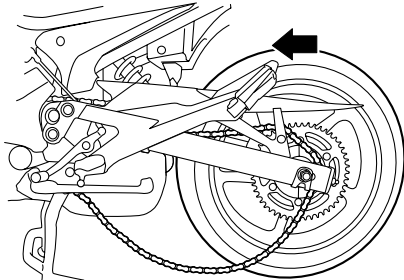

## TIP

- If the drive chain is difficult to remove, remove the wheel axle first, and then lift the wheel upward enough to remove the drive chain from the rear sprocket.
- The drive chain does not need to be disassembled in order to remove and install the rear wheel.

6. While supporting the brake caliper and slightly lifting the wheel, pull the wheel axle out.

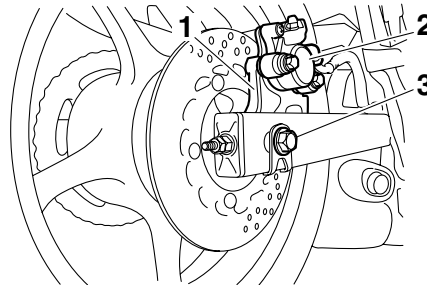

1. Brake caliper bracket
2. Brake caliper
3. Wheel axle

## TIP

A rubber mallet may be useful to tap the wheel axle out.

7. Remove the wheel. **NOTICE: Do not apply the brake after the wheel has been removed together with the brake disc, otherwise the brake pads will be forced shut.** [ECA11071]

EAU34434

## To install the rear wheel

1. Install the wheel and the brake caliper bracket by inserting the wheel axle from the right-hand side.

## TIP

- Make sure that the slot in the brake caliper bracket is fit over the retainer on the swingarm.
- Make sure that there is enough space between the brake pads before installing the wheel.



# PERIODIC MAINTENANCE AND ADJUSTMENT

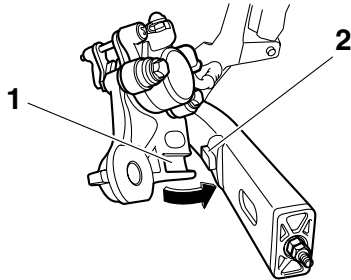

1. Slot
2. Retainer

2. Install the drive chain onto the rear sprocket.
3. Install the axle nut.
4. Lower the rear wheel so that it is on the ground, and then put the sidestand down.
5. Adjust the drive chain slack. (See page 6-26.)
6. Tighten the axle nut, and then tighten the locknuts to the specified torques.

## Tightening torques:

- Axle nut:  
90 Nm (9.0 m·kgf, 65 ft·lbf)
- Locknut:  
16 Nm (1.6 m·kgf, 12 ft·lbf)

EAU25871

## Troubleshooting

Although Yamaha motorcycles receive a thorough inspection before shipment from the factory, trouble may occur during operation. Any problem in the fuel, compression, or ignition systems, for example, can cause poor starting and loss of power.

The following troubleshooting charts represent quick and easy procedures for checking these vital systems yourself. However, should your motorcycle require any repair, take it to a Yamaha dealer, whose skilled technicians have the necessary tools, experience, and know-how to service the motorcycle properly.

Use only genuine Yamaha replacement parts. Imitation parts may look like Yamaha parts, but they are often inferior, have a shorter service life and can lead to expensive repair bills.

EWA15141

## WARNING

**When checking the fuel system, do not smoke, and make sure there are no open flames or sparks in the area, including pilot lights from water**

# PERIODIC MAINTENANCE AND ADJUSTMENT

EAU42362

## Troubleshooting charts

### Starting problems or poor engine performance

#### 1. Fuel

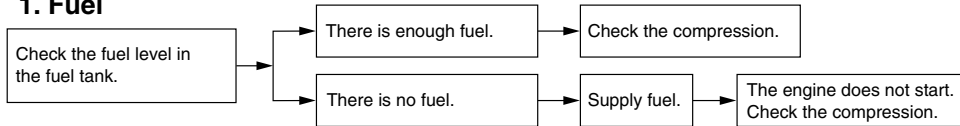

#### 2. Compression

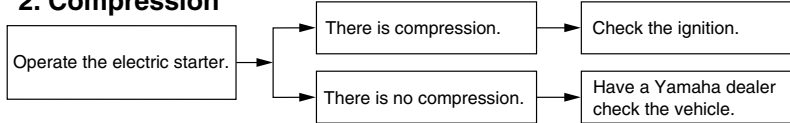

#### 3. Ignition

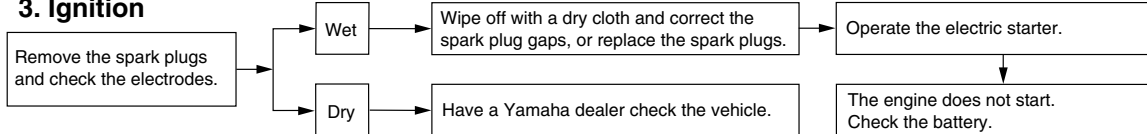

#### 4. Battery

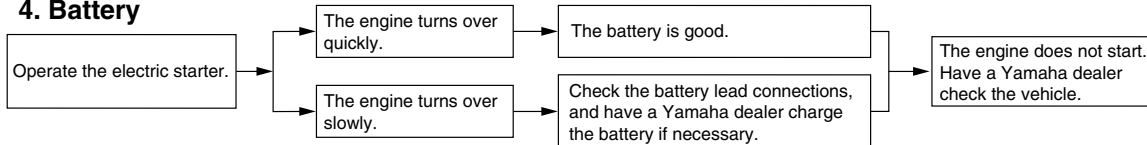

# PERIODIC MAINTENANCE AND ADJUSTMENT

## Engine overheating

EWA10400

### WARNING

- Do not remove the radiator cap when the engine and radiator are hot. Scalding hot fluid and steam may be blown out under pressure, which could cause serious injury. Be sure to wait until the engine has cooled.
- After removing the radiator cap retaining bolt, place a thick rag, like a towel, over the radiator cap, and then slowly rotate the cap counterclockwise to the detent to allow any residual pressure to escape. When the hissing sound has stopped, press down on the cap while turning it counterclockwise, and then remove the cap.

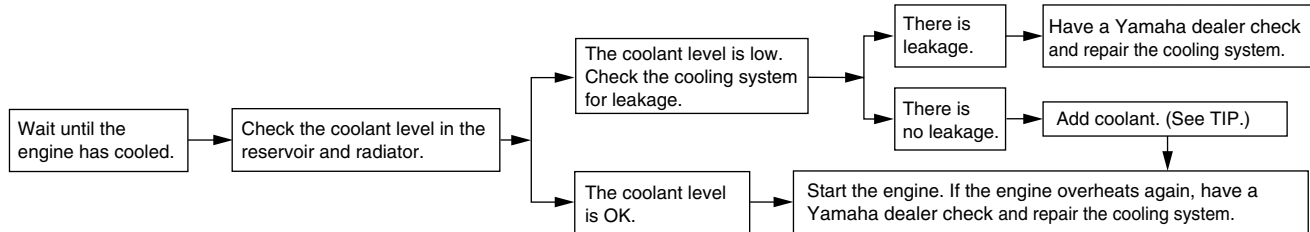

### TIP

If coolant is not available, tap water can be temporarily used instead, provided that it is changed to the recommended coolant as soon as possible.

# MOTORCYCLE CARE AND STORAGE

---

## Matte color caution

EAU37833

EAU26014

### **NOTICE**

---

Some models are equipped with matte colored finished parts. Be sure to consult a Yamaha dealer for advice on what products to use before cleaning the vehicle. Using a brush, harsh chemical products or cleaning compounds when cleaning these parts will scratch or damage their surface. Wax also should not be applied to any matte colored finished parts.

---

ECA15192

## Care

While the open design of a motorcycle reveals the attractiveness of the technology, it also makes it more vulnerable. Rust and corrosion can develop even if high-quality components are used. A rusty exhaust pipe may go unnoticed on a car, however, it detracts from the overall appearance of a motorcycle. Frequent and proper care does not only comply with the terms of the warranty, but it will also keep your motorcycle looking good, extend its life and optimize its performance.

## Before cleaning

1. Cover the muffler outlet with a plastic bag after the engine has cooled down.
2. Make sure that all caps and covers as well as all electrical couplers and connectors, including the spark plug caps, are tightly installed.
3. Remove extremely stubborn dirt, like oil burnt onto the crankcase, with a degreasing agent and a brush, but never apply such prod-

ucts onto seals, gaskets, sprockets, the drive chain and wheel axles. Always rinse the dirt and degreaser off with water.

## Cleaning

ECA10772

### **NOTICE**

---

- **Avoid using strong acidic wheel cleaners, especially on spoked wheels. If such products are used on hard-to-remove dirt, do not leave the cleaner on the affected area any longer than instructed. Also, thoroughly rinse the area off with water, immediately dry it, and then apply a corrosion protection spray.**
- **Improper cleaning can damage plastic parts (such as cowlings, panels, windshields, headlight lenses, meter lenses, etc.) and the mufflers. Use only a soft, clean cloth or sponge with water to clean plastic. However, if the plastic parts cannot be thoroughly cleaned with water, diluted mild detergent with water may be used. Be sure to rinse**

# MOTORCYCLE CARE AND STORAGE

off any detergent residue using plenty of water, as it is harmful to plastic parts.

- Do not use any harsh chemical products on plastic parts. Be sure to avoid using cloths or sponges which have been in contact with strong or abrasive cleaning products, solvent or thinner, fuel (gasoline), rust removers or inhibitors, brake fluid, antifreeze or electrolyte.
- Do not use high-pressure washers or steam-jet cleaners since they cause water seepage and deterioration in the following areas: seals (of wheel and swing-arm bearings, fork and brakes), electric components (couplers, connectors, instruments, switches and lights), breather hoses and vents.
- For motorcycles equipped with a windshield: Do not use strong cleaners or hard sponges as they will cause dulling or scratching. Some cleaning compounds for plastic may leave scratches on the windshield.

Test the product on a small hidden part of the windshield to make sure that it does not leave any marks. If the windshield is scratched, use a quality plastic polishing compound after washing.

## After normal use

Remove dirt with warm water, a mild detergent, and a soft, clean sponge, and then rinse thoroughly with clean water. Use a toothbrush or bottlebrush for hard-to-reach areas. Stubborn dirt and insects will come off more easily if the area is covered with a wet cloth for a few minutes before cleaning.

## After riding in the rain, near the sea or on salt-sprayed roads

Since sea salt or salt sprayed on roads during winter are extremely corrosive in combination with water, carry out the following steps after each ride in the rain, near the sea or on salt-sprayed roads.

## TIP

Salt sprayed on roads in the winter may remain well into spring.

1. Clean the motorcycle with cold water and a mild detergent, after the engine has cooled down.  
**NOTICE: Do not use warm water since it increases the corrosive action of the salt.** [ECA10791]
2. Apply a corrosion protection spray on all metal, including chrome- and nickel-plated, surfaces to prevent corrosion.

## After cleaning

1. Dry the motorcycle with a chamois or an absorbing cloth.
2. Immediately dry the drive chain and lubricate it to prevent it from rusting.
3. Use a chrome polish to shine chrome, aluminum and stainless-steel parts, including the exhaust system. (Even the thermally induced discoloring of stainless-steel exhaust systems can be removed through polishing.)

# MOTORCYCLE CARE AND STORAGE

---

ECA10800

4. To prevent corrosion, it is recommended to apply a corrosion protection spray on all metal, including chrome- and nickel-plated, surfaces.
5. Use spray oil as a universal cleaner to remove any remaining dirt.
6. Touch up minor paint damage caused by stones, etc.
7. Wax all painted surfaces.
8. Let the motorcycle dry completely before storing or covering it.

EWA11131

## WARNING

**Contaminants on the brakes or tires can cause loss of control.**

- **Make sure that there is no oil or wax on the brakes or tires.**
  - **If necessary, clean the brake discs and brake linings with a regular brake disc cleaner or acetone, and wash the tires with warm water and a mild detergent. Before riding at higher speeds, test the motorcycle's braking performance and cornering behavior.**
- 

## NOTICE

- **Apply spray oil and wax sparingly and make sure to wipe off any excess.**
  - **Never apply oil or wax to any rubber and plastic parts, but treat them with a suitable care product.**
  - **Avoid using abrasive polishing compounds as they will wear away the paint.**
- 

## TIP

- Consult a Yamaha dealer for advice on what products to use.
  - Washing, rainy weather or humid climates can cause the headlight lens to fog. Turning the headlight on for a short period of time will help remove the moisture from the lens.
- 

EAU26182

## Storage

### Short-term

Always store your motorcycle in a cool, dry place and, if necessary, protect it against dust with a porous cover. Be sure the engine and the exhaust system are cool before covering the motorcycle.

ECA10810

## NOTICE

- **Storing the motorcycle in a poorly ventilated room or covering it with a tarp, while it is still wet, will allow water and humidity to seep in and cause rust.**
  - **To prevent corrosion, avoid damp cellars, stables (because of the presence of ammonia) and areas where strong chemicals are stored.**
- 

### Long-term

Before storing your motorcycle for several months:

1. Follow all the instructions in the "Care" section of this chapter.

# MOTORCYCLE CARE AND STORAGE

2. Fill up the fuel tank and add fuel stabilizer (if available) to prevent the fuel tank from rusting and the fuel from deteriorating.
3. Perform the following steps to protect the cylinders, piston rings, etc. from corrosion.
  - a. Remove the spark plug caps and spark plugs.
  - b. Pour a teaspoonful of engine oil into each spark plug bore.
  - c. Install the spark plug caps onto the spark plugs, and then place the spark plugs on the cylinder head so that the electrodes are grounded. (This will limit sparking during the next step.)
  - d. Turn the engine over several times with the starter. (This will coat the cylinder walls with oil.)  
**WARNING! To prevent damage or injury from sparking, make sure to ground the spark plug electrodes while turning the engine over.**
  - e. Remove the spark plug caps from the spark plugs, and then install the spark plugs and the spark plug caps.
4. Lubricate all control cables and the pivoting points of all levers and pedals as well as of the side-stand/centerstand.
5. Check and, if necessary, correct the tire air pressure, and then lift the motorcycle so that both of its wheels are off the ground. Alternatively, turn the wheels a little every month in order to prevent the tires from becoming degraded in one spot.
6. Cover the muffler outlet with a plastic bag to prevent moisture from entering it.
7. Remove the battery and fully charge it. Store it in a cool, dry place and charge it once a month. Do not store the battery in an excessively cold or warm place [less than 0 °C (30 °F) or more than 30 °C (90 °F)]. For more information on storing the battery, see page 6-32.

[EWA10951]

---

## TIP

Make any necessary repairs before storing the motorcycle.

---

# SPECIFICATIONS

## Dimensions:

Overall length:  
2120 mm (83.5 in)  
Overall width:  
770 mm (30.3 in)  
Overall height:  
1085 mm (42.7 in)  
Seat height:  
785 mm (30.9 in)  
Wheelbase:  
1440 mm (56.7 in)  
Ground clearance:  
140 mm (5.51 in)  
Minimum turning radius:  
2800 mm (110.2 in)

## Weight:

Curb weight:  
XJ6N 205 kg (452 lb)  
XJ6NA 210 kg (463 lb)

## Engine:

Engine type:  
Liquid cooled 4-stroke, DOHC  
Cylinder arrangement:  
Inline 4-cylinder  
Displacement:  
600 cm<sup>3</sup>  
Bore × stroke:  
65.5 × 44.5 mm (2.58 × 1.75 in)  
Compression ratio:  
12.20 :1  
Starting system:  
Electric starter  
Lubrication system:  
Wet sump

## Engine oil:

Recommended brand:  
YAMALUBE  
Type:  
SAE 10W-30, 10W-40, 10W-50, 15W-40,  
20W-40 or 20W-50

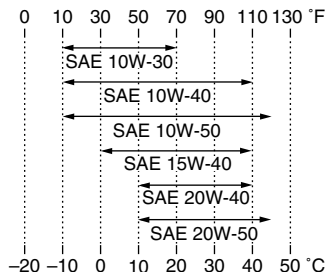

Recommended engine oil grade:  
API service SG type or higher, JASO  
standard MA

Engine oil quantity:  
Without oil filter cartridge replacement:  
2.50 L (2.64 US qt, 2.20 Imp.qt)  
With oil filter cartridge replacement:  
2.80 L (2.96 US qt, 2.46 Imp.qt)

## Cooling system:

Coolant reservoir capacity (up to the  
maximum level mark):  
0.25 L (0.26 US qt, 0.22 Imp.qt)  
Radiator capacity (including all routes):  
2.00 L (2.11 US qt, 1.76 Imp.qt)

## Air filter:

Air filter element:  
Oil-coated paper element

## Fuel:

Recommended fuel:  
Regular unleaded gasoline only  
Fuel tank capacity:  
17.3 L (4.57 US gal, 3.81 Imp.gal)  
Fuel reserve amount:  
3.2 L (0.85 US gal, 0.70 Imp.gal)

## Fuel injection:

Throttle body:  
ID mark:  
20S1 00

## Spark plug(s):

Manufacturer/model:  
NGK/CR9E  
Spark plug gap:  
0.7–0.8 mm (0.028–0.031 in)

## Clutch:

Clutch type:  
Wet, multiple-disc

## Transmission:

Primary reduction ratio:  
86/44 (1.955)  
Final drive:  
Chain  
Secondary reduction ratio:  
46/16 (2.875)  
Transmission type:  
Constant mesh 6-speed  
Operation:  
Left foot operation  
Gear ratio:  
1st:  
37/13 (2.846)



2nd:  
37/19 (1.947)  
3rd:  
28/18 (1.556)  
4th:  
32/24 (1.333)  
5th:  
25/21 (1.190)  
6th:  
26/24 (1.083)

## Chassis:

Frame type:  
Diamond  
Caster angle:  
26.00 °  
Trail:  
103.0 mm (4.06 in)

## Front tire:

Type:  
Tubeless  
Size:  
120/70 ZR17M/C (58W)  
Manufacturer/model:  
BRIDGESTONE/BT021  
Manufacturer/model:  
DUNLOP/ROADSMART

## Rear tire:

Type:  
Tubeless  
Size:  
160/60 ZR17M/C (69W)  
Manufacturer/model:  
BRIDGESTONE/BT021

Manufacturer/model:  
DUNLOP/ROADSMART

## Loading:

Maximum load:  
XJ6N 195 kg (430 lb)  
XJ6NA 190 kg (419 lb)  
(Total weight of rider, passenger, cargo and accessories)

## Tire air pressure (measured on cold tires):

Loading condition:  
0–90 kg (0–198 lb)  
Front:  
225 kPa (2.25 kgf/cm<sup>2</sup>, 33 psi)  
Rear:  
250 kPa (2.50 kgf/cm<sup>2</sup>, 36 psi)  
Loading condition:  
XJ6N 90–195 kg (198–430 lb)  
XJ6NA 90–190 kg (198–419 lb)  
Front:  
250 kPa (2.50 kgf/cm<sup>2</sup>, 36 psi)  
Rear:  
290 kPa (2.90 kgf/cm<sup>2</sup>, 42 psi)  
High-speed riding:  
Front:  
225 kPa (2.25 kgf/cm<sup>2</sup>, 33 psi)  
Rear:  
250 kPa (2.50 kgf/cm<sup>2</sup>, 36 psi)

## Front wheel:

Wheel type:  
Cast wheel  
Rim size:  
17M/C x MT3.50

## Rear wheel:

Wheel type:  
Cast wheel  
Rim size:  
17M/C x MT4.50

## Front brake:

Type:  
Dual disc brake  
Operation:  
Right hand operation  
Recommended fluid:  
DOT 4

## Rear brake:

Type:  
Single disc brake  
Operation:  
Right foot operation  
Recommended fluid:  
DOT 4

## Front suspension:

Type:  
Telescopic fork  
Spring/shock absorber type:  
Coil spring/oil damper  
Wheel travel:  
130.0 mm (5.12 in)

## Rear suspension:

Type:  
Swingarm  
Spring/shock absorber type:  
Coil spring/gas-oil damper  
Wheel travel:  
130.0 mm (5.12 in)

# SPECIFICATIONS

---

## Electrical system:

Ignition system:

TCI

Charging system:

AC magneto

## Battery:

Model:

GT12B-4

Voltage, capacity:

12 V, 10.0 Ah

## Headlight:

Bulb type:

Halogen bulb

## Bulb voltage, wattage × quantity:

Headlight:

12 V, 60 W/55 W × 1

Tail/brake light:

12 V, 5.0 W/21.0 W × 1

Front turn signal light:

12 V, 10.0 W × 2

Rear turn signal light:

12 V, 10.0 W × 2

Auxiliary light:

12 V, 5.0 W × 1

License plate light:

12 V, 5.0 W × 1

Meter lighting:

LED

Neutral indicator light:

LED

High beam indicator light:

LED

Oil level warning light:

LED

Turn signal indicator light:

LED

Coolant temperature warning light:

LED

Engine trouble warning light:

LED

ABS warning light:

XJ6NA LED

Immobilizer system indicator light:

LED

## Fuses:

Main fuse:

30.0 A

Headlight fuse:

20.0 A

Taillight fuse:

10.0 A

Signaling system fuse:

7.5 A

Ignition fuse:

10.0 A

Radiator fan fuse:

20.0 A

Fuel injection system fuse:

10.0 A

ABS control unit fuse:

XJ6NA 7.5 A

ABS motor fuse:

XJ6NA 30.0 A

ABS solenoid fuse:

XJ6NA 20.0 A

Backup fuse:

7.5 A

## Identification numbers

EAU48611

Record the vehicle identification number and model label information in the spaces provided below for assistance when ordering spare parts from a Yamaha dealer or for reference in case the vehicle is stolen.

VEHICLE IDENTIFICATION  
NUMBER:

MODEL LABEL INFORMATION:

## Vehicle identification number

EAU26400

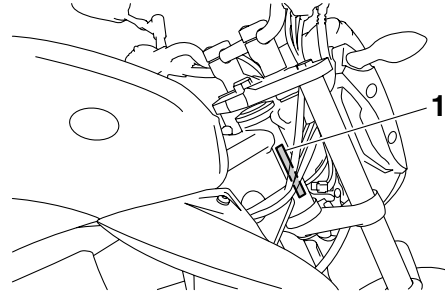

1. Vehicle identification number

The vehicle identification number is stamped into the steering head pipe. Record this number in the space provided.

**TIP** \_\_\_\_\_  
The vehicle identification number is used to identify your motorcycle and may be used to register your motorcycle with the licensing authority in your area.

## Model label

EAU26480

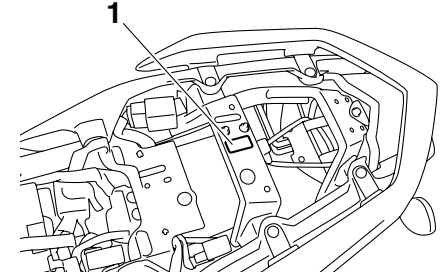

1. Model label

The model label is affixed to the frame under the seat. (See page 3-18.) Record the information on this label in the space provided. This information will be needed when ordering spare parts from a Yamaha dealer.

# INDEX

---

- A**  
ABS (for ABS models) ..... 3-14  
ABS warning light (for ABS models) ..... 3-7  
Air filter element, replacing ..... 6-17  
Anti-theft alarm (optional)..... 3-11  
Auxiliary light bulb, replacing ..... 6-40
- B**  
Battery..... 6-32  
Brake and clutch levers,  
  checking and lubricating ..... 6-30  
Brake and shift pedals,  
  checking and lubricating ..... 6-29  
Brake fluid, changing ..... 6-26  
Brake fluid level, checking ..... 6-25  
Brake lever..... 3-14  
Brake lever free play, checking..... 6-23  
Brake light switches  
  (for ABS models) ..... 6-24  
Brake light switches  
  (for non-ABS models) ..... 6-24  
Brake pedal..... 3-14
- C**  
Cables, checking and lubricating ..... 6-28  
Care ..... 7-1  
Catalytic converter ..... 3-17  
Clutch lever ..... 3-13  
Clutch lever free play, adjusting..... 6-22  
Coolant..... 6-13  
Coolant temperature warning light..... 3-4  
Cowling and panels, removing and  
  installing..... 6-8
- D**  
Dimmer switch ..... 3-12  
Drive chain, cleaning and lubricating .... 6-28  
Drive chain slack ..... 6-26
- E**  
Engine break-in ..... 5-3  
Engine idling speed ..... 6-18  
Engine oil and oil filter cartridge ..... 6-10  
Engine stop switch..... 3-12  
Engine trouble warning light ..... 3-7
- F**  
Front and rear brake pads, checking.... 6-24  
Front fork, checking..... 6-31  
Fuel..... 3-16  
Fuel consumption, tips for reducing..... 5-3  
Fuel tank breather/overflow hose ..... 3-17  
Fuel tank cap..... 3-15  
Fuses, replacing ..... 6-34
- H**  
Handlebar position, adjusting ..... 3-20  
Handlebar switches ..... 3-12  
Hazard switch ..... 3-13  
Headlight bulb, replacing..... 6-36  
Helmet holder ..... 3-19  
High beam indicator light..... 3-4  
Horn switch..... 3-12
- I**  
Identification numbers ..... 9-1  
Ignition circuit cut-off system ..... 3-22  
Immobilizer system..... 3-1  
Immobilizer system indicator light..... 3-7  
Indicator lights and warning lights ..... 3-4
- L**  
License plate light bulb, replacing ..... 6-39
- M**  
Main switch/steering lock..... 3-2  
Maintenance and lubrication, periodic .... 6-4  
Maintenance, emission control system ... 6-3  
Matte color, caution..... 7-1  
Model label..... 9-1  
Multi-function meter unit..... 3-8
- N**  
Neutral indicator light ..... 3-4
- O**  
Oil level warning light ..... 3-4
- P**  
Parking..... 5-4  
Part locations ..... 2-1  
Pass switch ..... 3-12
- S**  
Safety information ..... 1-1  
Seat..... 3-18  
Shifting ..... 5-2  
Shift pedal ..... 3-13  
Shock absorber assembly, adjusting .... 3-20  
Sidestand ..... 3-21  
Sidestand, checking and lubricating..... 6-30  
Spark plugs, checking ..... 6-9  
Specifications ..... 8-1  
Starting the engine ..... 5-1  
Start switch..... 3-12  
Steering, checking..... 6-32  
Storage..... 7-3  
Storage compartment..... 3-19  
Supporting the motorcycle ..... 6-40  
Swingarm pivots, lubricating ..... 6-31
- T**  
Tail/brake light bulb, replacing ..... 6-38  
Throttle grip and cable, checking and  
  lubricating ..... 6-29  
Throttle grip free play, checking ..... 6-19

Tires.....	6-19
Tool kit.....	6-2
Troubleshooting.....	6-44
Troubleshooting charts.....	6-45
Turn signal indicator light.....	3-4
Turn signal light bulb, replacing.....	6-39
Turn signal switch.....	3-12

## **V**

Valve clearance.....	6-19
Vehicle identification number.....	9-1

## **W**

Wheel bearings, checking.....	6-32
Wheel, front (for non-ABS models).....	6-41
Wheel, rear (for non-ABS models).....	6-42
Wheels.....	6-22







PRINTED ON RECYCLED PAPER

PRINTED IN JAPAN  
2010.08-0.3×2 CR  
(E)