



OWNER'S MANUAL  
***YBR125 CUSTOM***  
***YBR125***

27S-F8199-E0



Welcome to the Yamaha world of motorcycling!

As the owner of the YBR125, you are benefiting from Yamaha's vast experience and newest technology regarding the design and manufacture of high-quality products, which have earned Yamaha a reputation for dependability.

Please take the time to read this manual thoroughly, so as to enjoy all advantages of your YBR125. The owner's manual does not only instruct you in how to operate, inspect and maintain your motorcycle, but also in how to safeguard yourself and others from trouble and injury.

In addition, the many tips given in this manual will help keep your motorcycle in the best possible condition. If you have any further questions, do not hesitate to contact your Yamaha dealer.

The Yamaha team wishes you many safe and pleasant rides. So, remember to put safety first!



# IMPORTANT MANUAL INFORMATION

---

---

EAU10151

Particularly important information is distinguished in this manual by the following notations:

	<b>The Safety Alert Symbol means ATTENTION! BECOME ALERT! YOUR SAFETY IS INVOLVED!</b>
	<b>Failure to follow WARNING instructions could result in severe injury or death to the motorcycle operator, a bystander, or a person inspecting or repairing the motorcycle.</b>
<b>CAUTION:</b>	<b>A CAUTION indicates special precautions that must be taken to avoid damage to the motorcycle.</b>
<b>NOTE:</b>	A NOTE provides key information to make procedures easier or clearer.

## NOTE:

- This manual should be considered a permanent part of this motorcycle and should remain with it even if the motorcycle is subsequently sold.
- Yamaha continually seeks advancements in product design and quality. Therefore, while this manual contains the most current product information available at the time of printing, there may be minor discrepancies between your motorcycle and this manual. If you have any questions concerning this manual, please consult your Yamaha dealer.

EWA10030

## **WARNING**

**PLEASE READ THIS MANUAL CAREFULLY AND COMPLETELY BEFORE OPERATING THIS MOTORCYCLE.**

---

\*Product and specifications are subject to change without notice.

# IMPORTANT MANUAL INFORMATION

---

---

EAU37230

**YBR125  
OWNER'S MANUAL  
©2008 by Yamaha Motor Co., Ltd.  
1st edition, February 2008  
All rights reserved.  
Any reprinting or unauthorized use  
without the written permission of  
Yamaha Motor Co., Ltd.  
is expressly prohibited.  
Printed in China.**

# TABLE OF CONTENTS

---

<b>SAFETY INFORMATION</b> .....	1-1	<b>PRE-OPERATION CHECKS</b> .....	4-1	Checking the front brake lever free play .....	6-17
<b>DESCRIPTION</b> .....	2-1	Pre-operation check list .....	4-2	Adjusting the brake pedal free play .....	6-17
Left view .....	2-1	<b>OPERATION AND IMPORTANT</b>		Checking the shift pedal .....	6-18
Right view .....	2-2	<b>RIDING POINTS</b> .....	5-1	Adjusting the rear brake light switch .....	6-18
Controls and instruments.....	2-3	Starting the engine .....	5-1	Checking the front brake pads and rear brake shoes .....	6-19
<b>INSTRUMENT AND CONTROL</b>		Shifting .....	5-2	Checking the front brake fluid level .....	6-19
<b>FUNCTIONS</b> .....	3-1	Tips for reducing fuel consumption .....	5-3	Changing the brake fluid .....	6-20
Main switch/steering lock .....	3-1	Engine break-in .....	5-3	Drive chain slack .....	6-21
Indicator and warning lights .....	3-2	Parking .....	5-4	Cleaning and lubricating the drive chain .....	6-22
Speedometer unit .....	3-2	<b>PERIODIC MAINTENANCE AND</b>		Checking and lubricating the cables .....	6-23
Tachometer .....	3-3	<b>MINOR REPAIR</b> .....	6-1	Checking and lubricating the throttle grip and cable .....	6-23
Self-diagnosis device .....	3-3	Owner's tool kit .....	6-1	Checking and lubricating the brake and clutch levers .....	6-23
Fuel gauge .....	3-3	Periodic maintenance and lubrication chart .....	6-2	Checking and lubricating the brake pedal .....	6-24
Handlebar switches .....	3-4	Removing and installing panels .....	6-6	Checking and lubricating the centerstand and sidestand .....	6-24
Clutch lever .....	3-5	Checking the spark plug .....	6-7	Lubricating the swingarm pivots .....	6-25
Shift pedal .....	3-5	Engine oil .....	6-9	Checking the front fork .....	6-25
Brake lever .....	3-5	Cleaning the air filter element .....	6-10	Checking the steering .....	6-26
Brake pedal .....	3-6	Checking the engine idling speed .....	6-12	Checking the wheel bearings .....	6-26
Fuel tank cap .....	3-6	Adjusting the throttle cable free play .....	6-12	Battery .....	6-27
Fuel .....	3-7	Valve clearance .....	6-13		
Catalytic converters .....	3-8	Tires .....	6-13		
Kickstarter .....	3-8	Cast wheels .....	6-15		
Adjusting the shock absorber assemblies .....	3-8	Adjusting the clutch lever free play .....	6-16		
Carrier .....	3-9				
Sidestand .....	3-9				
Ignition circuit cut-off system .....	3-10				

# TABLE OF CONTENTS

---

---

Replacing the fuse .....	6-28
Replacing the headlight bulb .....	6-29
Replacing the tail/brake light bulb .....	6-30
Replacing a turn signal light bulb .....	6-31
Replacing the auxiliary light bulb .....	6-31
Front wheel .....	6-32
Rear wheel .....	6-34
Troubleshooting .....	6-36
Troubleshooting chart .....	6-37

## **MOTORCYCLE CARE AND**

<b>STORAGE</b> .....	7-1
Matte color caution .....	7-1
Care .....	7-1
Storage .....	7-3

## **SPECIFICATIONS** .....

8-1

## **CONSUMER INFORMATION**.....

9-1

Identification numbers .....	9-1
------------------------------	-----

# SAFETY INFORMATION

EAU10281

1

MOTORCYCLES ARE SINGLE TRACK VEHICLES. THEIR SAFE USE AND OPERATION ARE DEPENDENT UPON THE USE OF PROPER RIDING TECHNIQUES AS WELL AS THE EXPERTISE OF THE OPERATOR. EVERY OPERATOR SHOULD KNOW THE FOLLOWING REQUIREMENTS BEFORE RIDING THIS MOTORCYCLE.

HE OR SHE SHOULD:

- OBTAIN THOROUGH INSTRUCTIONS FROM A COMPETENT SOURCE ON ALL ASPECTS OF MOTORCYCLE OPERATION.
- OBSERVE THE WARNINGS AND MAINTENANCE REQUIREMENTS IN THE OWNER'S MANUAL.
- OBTAIN QUALIFIED TRAINING IN SAFE AND PROPER RIDING TECHNIQUES.
- OBTAIN PROFESSIONAL TECHNICAL SERVICE AS INDICATED BY THE OWNER'S MANUAL

AND/OR WHEN MADE NECESSARY BY MECHANICAL CONDITIONS.

## Safe riding

- Always make pre-operation checks. Careful checks may help prevent an accident.
- This motorcycle is designed to carry the operator and a passenger.
- The failure of motorists to detect and recognize motorcycles in traffic is the predominating cause of automobile/motorcycle accidents. Many accidents have been caused by an automobile driver who did not see the motorcycle. Making yourself conspicuous appears to be very effective in reducing the chance of this type of accident.

## Therefore:

- Wear a brightly colored jacket.
- Use extra caution when you are approaching and passing through intersections, since intersections are the most likely places for motorcycle accidents to occur.

- Ride where other motorists can see you. Avoid riding in another motorist's blind spot.
- Many accidents involve inexperienced operators. In fact, many operators who have been involved in accidents do not even have a current motorcycle license.
- Make sure that you are qualified and that you only lend your motorcycle to other qualified operators.
- Know your skills and limits. Staying within your limits may help you to avoid an accident.
- We recommend that you practice riding your motorcycle where there is no traffic until you have become thoroughly familiar with the motorcycle and all of its controls.
- Many accidents have been caused by error of the motorcycle operator. A typical error made by the operator is veering wide on a turn



due to EXCESSIVE SPEED or undercornering (insufficient lean angle for the speed).

- Always obey the speed limit and never travel faster than warranted by road and traffic conditions.
- Always signal before turning or changing lanes. Make sure that other motorists can see you.
- The posture of the operator and passenger is important for proper control.
  - The operator should keep both hands on the handlebar and both feet on the operator footrests during operation to maintain control of the motorcycle.
  - The passenger should always hold onto the operator, the seat strap or grab bar, if equipped, with both hands and keep both feet on the passenger footrests.
  - Never carry a passenger unless he or she can firmly place both feet on the passenger footrests.
- Never ride under the influence of alcohol or other drugs.

- This motorcycle is designed for on-road use only. It is not suitable for off-road use.

### **Protective apparel**

The majority of fatalities from motorcycle accidents are the result of head injuries. The use of a safety helmet is the single most critical factor in the prevention or reduction of head injuries.

- Always wear an approved helmet.
- Wear a face shield or goggles. Wind in your unprotected eyes could contribute to an impairment of vision that could delay seeing a hazard.
- The use of a jacket, heavy boots, trousers, gloves, etc., is effective in preventing or reducing abrasions or lacerations.
- Never wear loose-fitting clothes, otherwise they could catch on the control levers, footrests, or wheels and cause injury or an accident.
- Never touch the engine or exhaust system during or after operation. They become very hot and can

cause burns. Always wear protective clothing that covers your legs, ankles, and feet.

- A passenger should also observe the above precautions.

### **Modifications**

Modifications made to this motorcycle not approved by Yamaha, or the removal of original equipment, may render the motorcycle unsafe for use and may cause severe personal injury. Modifications may also make your motorcycle illegal to use.

### **Loading and accessories**

Adding accessories or cargo to your motorcycle can adversely affect stability and handling if the weight distribution of the motorcycle is changed. To avoid the possibility of an accident, use extreme caution when adding cargo or accessories to your motorcycle. Use extra care when riding a motorcycle that has added cargo or accessories. Here are some general guidelines to follow if loading cargo or adding accessories to your motorcycle:

# SAFETY INFORMATION

1

## Loading

The total weight of the operator, passenger, accessories and cargo must not exceed the maximum load limit.

**Maximum load:**  
190 kg (419 lb)

When loading within this weight limit, keep the following in mind:

- Cargo and accessory weight should be kept as low and close to the motorcycle as possible. Make sure to distribute the weight as evenly as possible on both sides of the motorcycle to minimize imbalance or instability.
- Shifting weights can create a sudden imbalance. Make sure that accessories and cargo are securely attached to the motorcycle before riding. Check accessory mounts and cargo restraints frequently.
- Never attach any large or heavy items to the handlebar, front fork, or front fender. These items, including such cargo as sleeping

bags, duffel bags, or tents, can create unstable handling or a slow steering response.

## Accessories

Genuine Yamaha accessories have been specifically designed for use on this motorcycle. Since Yamaha cannot test all other accessories that may be available, you must personally be responsible for the proper selection, installation and use of non-Yamaha accessories. Use extreme caution when selecting and installing any accessories.

Keep the following guidelines in mind, as well as those provided under “Loading” when mounting accessories.

- Never install accessories or carry cargo that would impair the performance of your motorcycle. Carefully inspect the accessory before using it to make sure that it does not in any way reduce ground clearance or cornering clearance,

limit suspension travel, steering travel or control operation, or obscure lights or reflectors.

- Accessories fitted to the handlebar or the front fork area can create instability due to improper weight distribution or aerodynamic changes. If accessories are added to the handlebar or front fork area, they must be as lightweight as possible and should be kept to a minimum.
- Bulky or large accessories may seriously affect the stability of the motorcycle due to aerodynamic effects. Wind may attempt to lift the motorcycle, or the motorcycle may become unstable in cross winds. These accessories may also cause instability when passing or being passed by large vehicles.
- Certain accessories can displace the operator from his or her normal riding position. This improper position limits the freedom of movement of the opera-

tor and may limit control ability, therefore, such accessories are not recommended.

- Use caution when adding electrical accessories. If electrical accessories exceed the capacity of the motorcycle's electrical system, an electric failure could result, which could cause a dangerous loss of lights or engine power.

### **Gasoline and exhaust gas**

- **GASOLINE IS HIGHLY FLAMMABLE:**
  - Always turn the engine off when refueling.
  - Take care not to spill any gasoline on the engine or exhaust system when refueling.
  - Never refuel while smoking or in the vicinity of an open flame.
- Never start the engine or let it run for any length of time in a closed area. The exhaust fumes are poisonous and may cause loss of consciousness and death within a short time. Always operate your motorcycle in an area that has adequate ventilation.

- Always turn the engine off before leaving the motorcycle unattended and remove the key from the main switch. When parking the motorcycle, note the following:
  - The engine and exhaust system may be hot, therefore, park the motorcycle in a place where pedestrians or children are not likely to touch these hot areas.
  - Do not park the motorcycle on a slope or soft ground, otherwise it may fall over.
  - Do not park the motorcycle near a flammable source, (e.g., a kerosene heater, or near an open flame), otherwise it could catch fire.
- When transporting the motorcycle in another vehicle, make sure that it is kept upright. If the motorcycle should lean over, gasoline may leak out of the fuel tank.
- If you should swallow any gasoline, inhale a lot of gasoline vapor, or allow gasoline to get into your eyes, see your doctor immediately. If any gasoline spills on your skin

or clothing, immediately wash the affected area with soap and water and change your clothes.

# DESCRIPTION

EAU10410

## Left view

2

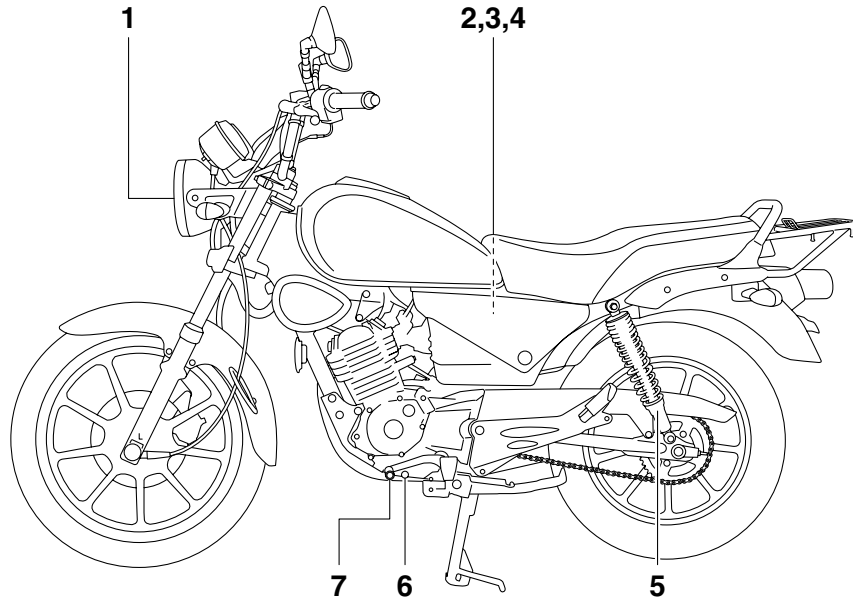

1. Headlight (page 6-29)
2. Fuse (page 6-28)
3. Battery (page 6-27)
4. Owner's tool kit (page 6-1)
5. Shock absorber assembly spring preload adjusting ring (page 3-8)
6. Engine oil drain bolt (page 6-9)
7. Shift pedal (page 3-5)

## Right view

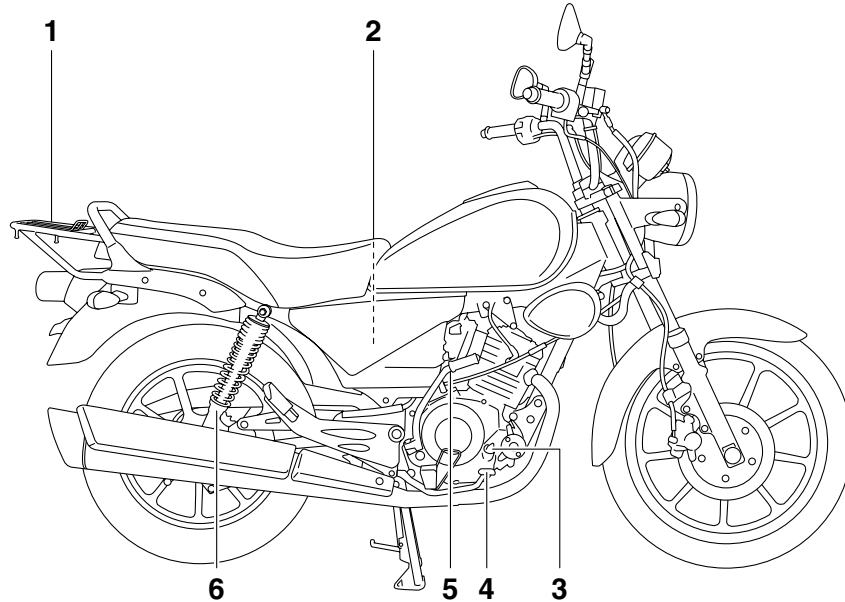

1. Carrier (page 3-9)
2. Air filter element (page 6-10)
3. Engine oil filler cap (page 6-9)
4. Brake pedal (page 3-6)
5. Kickstarter (page 3-8)
6. Shock absorber assembly spring preload adjusting ring (page 3-8)

# DESCRIPTION

EAU10430

## Controls and instruments

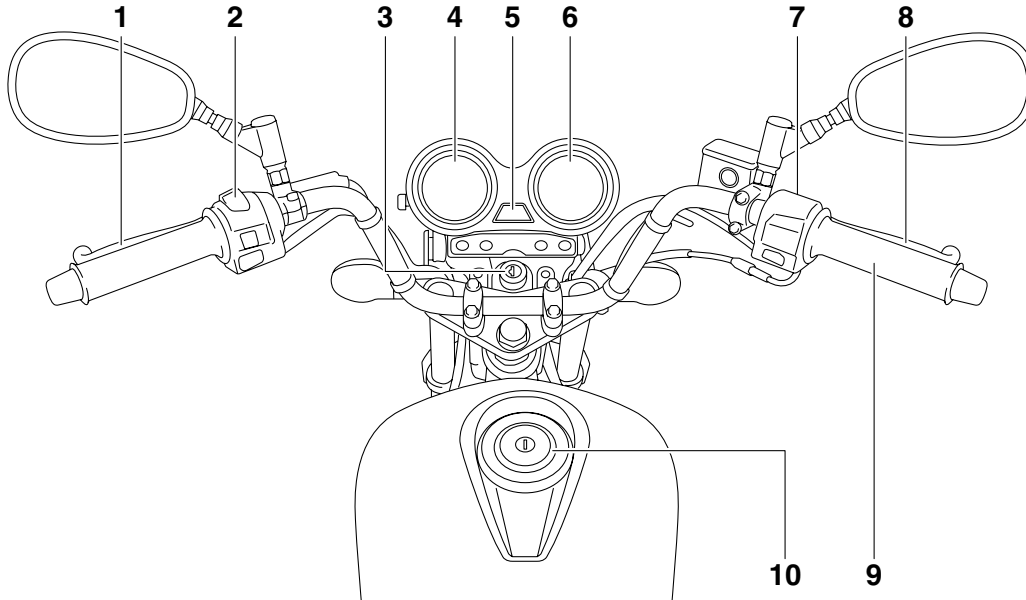

1. Clutch lever (page 3-5)
2. Left handlebar switches (page 3-4)
3. Main switch/steering lock (page 3-1)
4. Speedometer (page 3-2)
5. Fuel gauge (page 3-3)
6. Tachometer (page 3-3)
7. Right handlebar switch (page 3-4)
8. Brake lever (page 3-5)

9. Throttle grip (page 6-12)
10. Fuel tank cap (page 3-6)

# INSTRUMENT AND CONTROL FUNCTIONS

## Main switch/steering lock

EAU10460

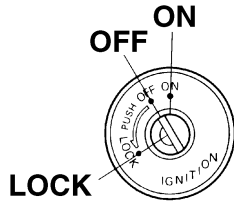

The main switch/steering lock controls the ignition and lighting systems, and is used to lock the steering. The various positions are described below.

### ON

EAU33590

All electrical circuits are supplied with power; the meter lighting, taillight and auxiliary light come on, and the engine can be started. The key cannot be removed.

### NOTE:

The headlight comes on automatically when the engine is started and stays on until the key is turned to "OFF", even if the engine stalls.

### OFF

EAU10660

All electrical systems are off. The key can be removed.

### LOCK

EAU43140

The steering is locked, and all electrical systems are off. The key can be removed.

### To lock the steering

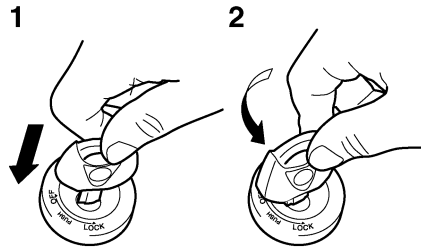

1. Push.
2. Turn.

1. Turn the handlebars all the way to the left.
2. Push the key in from the "OFF" position, and then turn it to "LOCK" while still pushing it.
3. Remove the key.

### To unlock the steering

1

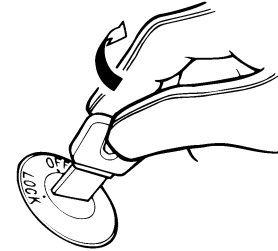

1. Turn.

Insert the key and turn it to "OFF".

EWA10060

### **! WARNING**





Never turn the key to "OFF" or "LOCK" while the vehicle is moving, otherwise the electrical systems will be switched off, which may result in loss of control or an accident. Make sure that the vehicle is stopped before turning the key to "OFF" or "LOCK".

# INSTRUMENT AND CONTROL FUNCTIONS

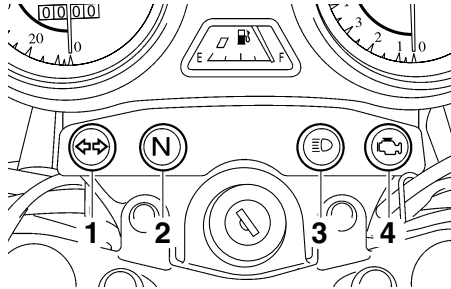
## Indicator and warning lights

EAU11003



1. Turn signal indicator light “ ”
2. Neutral indicator light “**N**”
3. High beam indicator light “”
4. Engine trouble warning light “”

## Turn signal indicator light “ ”

EAU11020

This indicator light flashes when the turn signal switch is pushed to the left or right.

## Neutral indicator light “**N**”

EAU11060

This indicator light comes on when the transmission is in the neutral position.

## High beam indicator light “”

EAU11080

This indicator light comes on when the high beam of the headlight is switched on.

## Engine trouble warning light “”

EAU45740

This warning light comes on or flashes when an electrical circuit monitoring the engine is defective. When this occurs, have a Yamaha dealer check the self-diagnosis system. (See page 3-3 for an explanation of the self-diagnosis device.)

The electrical circuit of the warning light can be checked by turning the key to “ON”. If the warning light does not come on for a few seconds, then go off, have a Yamaha dealer check the electrical circuit.

## Speedometer unit

EAU11630

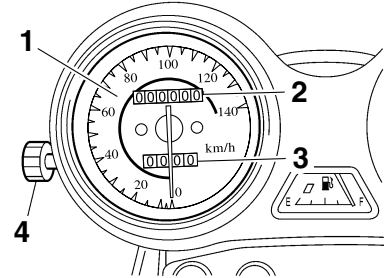

1. Speedometer
2. Odometer
3. Tripmeter
4. Tripmeter reset knob

The speedometer unit is equipped with a speedometer, an odometer and a tripmeter. The speedometer shows riding speed. The odometer shows the total distance traveled. The tripmeter shows the distance traveled since it was last set to zero with the reset knob. The tripmeter can be used to estimate the distance that can be traveled with a full tank of fuel. This information will enable you to plan future fuel stops.



## Tachometer

EAU11851

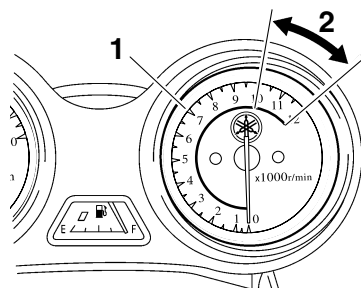

1. Tachometer
2. Tachometer red zone

The electric tachometer allows the rider to monitor the engine speed and keep it within the ideal power range.

ECA10031

### CAUTION:

**Do not operate the engine in the tachometer red zone.**

**Red zone: 10000 r/min and above**

## Self-diagnosis device

EAU12090

This model is equipped with a self-diagnosis device for various electrical circuits.

If any of those circuits are defective, the engine trouble warning light will come on or flash. If this occurs, have a Yamaha dealer check the vehicle.

ECA11170

### CAUTION:

**To prevent engine damage, be sure to consult a Yamaha dealer as soon as possible if this occurs.**

## Fuel gauge

EAU37052

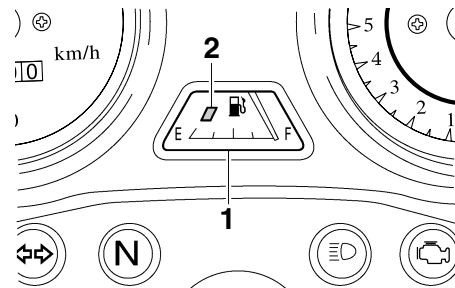

1. Fuel gauge
2. Red zone

The fuel gauge indicates the amount of fuel in the fuel tank. The needle moves towards “E” (Empty) as the fuel level decreases. When the needle reaches the red zone, approximately 3.0 L (0.79 US gal, 0.66 Imp.gal) remain in the fuel tank. If this occurs, refuel as soon as possible.

### NOTE:

The main switch must be turned to “ON” for the fuel gauge to display an accurate fuel level reading.

# INSTRUMENT AND CONTROL FUNCTIONS

## Handlebar switches

EAU12347

### Left

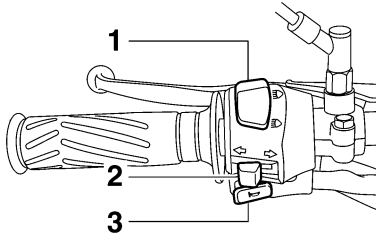

1. Dimmer switch “ $\equiv$ ○/ $\equiv$ ○”
2. Turn signal switch “ $\leftarrow$ / $\rightarrow$ ”
3. Horn switch “ $\updownarrow$ ”

### Right

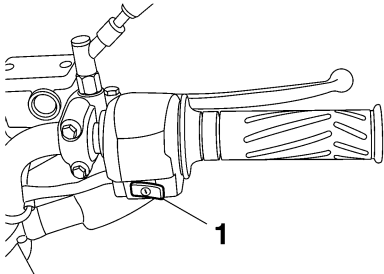

1. Start switch “ $\infty$ ”

### Dimmer switch “ $\equiv$ ○/ $\equiv$ ○”

EAU12400

Set this switch to “ $\equiv$ ○” for the high beam and to “ $\equiv$ ○” for the low beam.

### Turn signal switch “ $\leftarrow$ / $\rightarrow$ ”

EAU12460

To signal a right-hand turn, push this switch to “ $\rightarrow$ ”. To signal a left-hand turn, push this switch to “ $\leftarrow$ ”. When released, the switch returns to the center position. To cancel the turn signal lights, push the switch in after it has returned to the center position.

### Horn switch “ $\updownarrow$ ”

EAU12500

Press this switch to sound the horn.

### Start switch “ $\infty$ ”

EAU12710

Push this switch to crank the engine with the starter.

ECA10050

### CAUTION:

See page 5-1 for starting instructions prior to starting the engine.

The engine trouble warning light will come on when the key is turned to “ON” and the start switch is pushed, but this does not indicate a malfunction.

EAU41700

# INSTRUMENT AND CONTROL FUNCTIONS

## Clutch lever

EAU12820

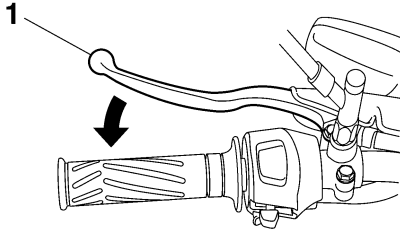

1. Clutch lever

The clutch lever is located at the left handlebar grip. To disengage the clutch, pull the lever toward the handlebar grip. To engage the clutch, release the lever. The lever should be pulled rapidly and released slowly for smooth clutch operation.

The clutch lever is equipped with a clutch switch, which is part of the ignition circuit cut-off system. (See page 3-10.)

## Shift pedal

EAU12870

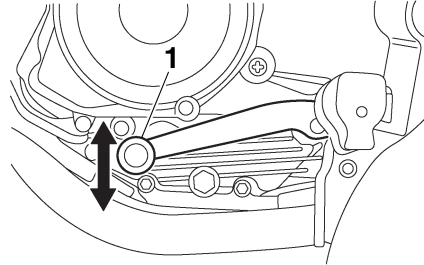

1. Shift pedal

The shift pedal is located on the left side of the engine and is used in combination with the clutch lever when shifting the gears of the 5-speed constant-mesh transmission equipped on this motorcycle.

## Brake lever

EAU12890

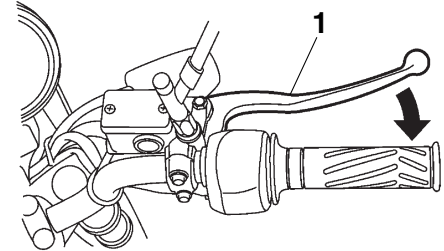

1. Brake lever

The brake lever is located at the right handlebar grip. To apply the front brake, pull the lever toward the handlebar grip.

# INSTRUMENT AND CONTROL FUNCTIONS

## Brake pedal

EAU12941

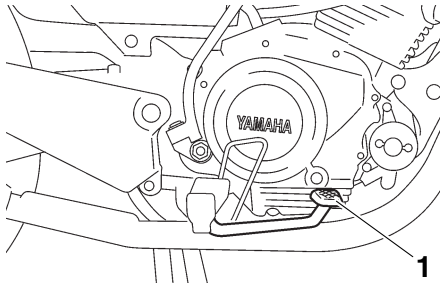

1. Brake pedal

The brake pedal is on the right side of the motorcycle. To apply the rear brake, press down on the brake pedal.

## Fuel tank cap

EAU13001

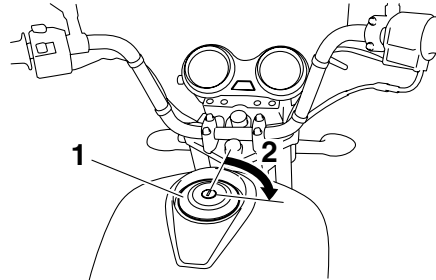

1. Fuel tank cap
2. Unlock.

### To remove the fuel tank cap

Insert the key into the lock and turn it 1/4 turn clockwise. The lock will be released and the fuel tank cap can be removed.

### To install the fuel tank cap

1. Push the fuel tank cap into position with the key inserted in the lock.
2. Turn the key counterclockwise to the original position, and then remove it.

### NOTE: \_\_\_\_\_

The fuel tank cap cannot be installed unless the key is in the lock. In addition, the key cannot be removed if the cap is not properly installed and locked.

EWA11140

### **! WARNING** \_\_\_\_\_

**Make sure that the fuel tank cap is properly installed before riding.**

# INSTRUMENT AND CONTROL FUNCTIONS

## Fuel

EAU13220

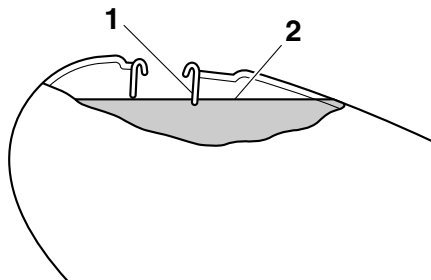

1. Fuel tank filler tube
2. Fuel level

Make sure that there is sufficient fuel in the tank. When refueling, be sure to insert the pump nozzle into the fuel tank filler hole and to fill the tank to the bottom of the filler tube as shown.

EWA10880

### **WARNING**

- Do not overfill the fuel tank, otherwise it may overflow when the fuel warms up and expands.
- Avoid spilling fuel on the hot engine.

ECA10070

### **CAUTION:**

Immediately wipe off spilled fuel with a clean, dry, soft cloth, since fuel may deteriorate painted surfaces or plastic parts.

or premium unleaded fuel. Use of unleaded fuel will extend spark plug life and reduce maintenance costs.

EAU13320

### **Recommended fuel:**

REGULAR UNLEADED GASOLINE ONLY

### **Fuel tank capacity:**

12.0 L (3.17 US gal, 2.64 Imp.gal)

### **Fuel reserve amount:**

3.0 L (0.79 US gal, 0.66 Imp.gal)

ECA11400

### **CAUTION:**

Use only unleaded gasoline. The use of leaded gasoline will cause severe damage to internal engine parts, such as the valves and piston rings, as well as to the exhaust system.

Your Yamaha engine has been designed to use regular unleaded gasoline with a research octane number of 91 or higher. If knocking (or pinging) occurs, use a gasoline of a different brand

# INSTRUMENT AND CONTROL FUNCTIONS

## Catalytic converters

EAU13443

This vehicle is equipped with catalytic converters in the exhaust system.

EWA10860

### **WARNING**

The exhaust system is hot after operation. Make sure that the exhaust system has cooled down before doing any maintenance work.

ECA16490

### **CAUTION:**

The following precautions must be observed to prevent a fire hazard or other damages.

- Use only unleaded gasoline. The use of leaded gasoline will cause unrepairable damage to the catalytic converters.
- Never park the vehicle near possible fire hazards such as grass or other materials that easily burn.
- Do not allow the engine to idle too long.

## Kickstarter

EAU43150

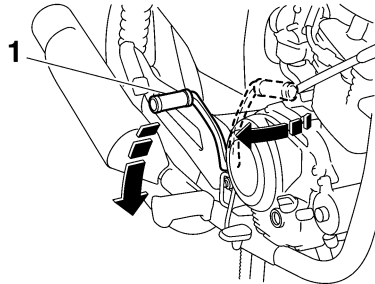

1. Kickstarter lever

If the engine fails to start by pushing the start switch, try to start it by using the kickstarter. To start the engine, fold out the kickstarter lever, move it down lightly with your foot until the gears engage, and then push it down smoothly but forcefully. This model is equipped with a primary kickstarter, allowing the engine to be started in any gear if the clutch is disengaged and the sidestand is up. However, shifting the transmission into the neutral position before starting is recommended.

## Adjusting the shock absorber assemblies

EAU14880

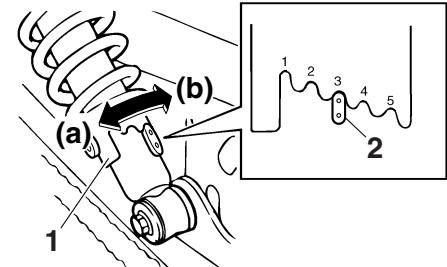

1. Spring preload adjusting ring
2. Position indicator

Each shock absorber assembly is equipped with a spring preload adjusting ring.

ECA10100

### **CAUTION:**

Never attempt to turn an adjusting mechanism beyond the maximum or minimum settings.

EWA10210

## **WARNING**

Always adjust both shock absorber assemblies equally, otherwise poor handling and loss of stability may result.

Adjust the spring preload as follows. To increase the spring preload and thereby harden the suspension, turn the adjusting ring on each shock absorber assembly in direction (a). To decrease the spring preload and thereby soften the suspension, turn the adjusting ring on each shock absorber assembly in direction (b).

### **NOTE:**

Align the appropriate notch in the adjusting ring with the position indicator on the shock absorber.

#### **Spring preload setting:**

- Minimum (soft):  
1
- Standard:  
3
- Maximum (hard):  
5

## Carrier

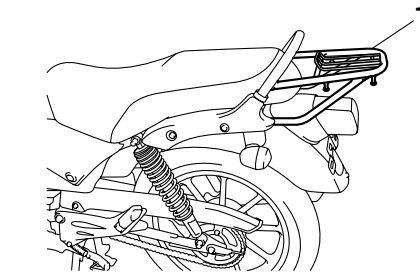

1. Carrier

EAU15111

## Sidestand

The sidestand is located on the left side of the frame. Raise the sidestand or lower it with your foot while holding the vehicle upright.

### **NOTE:**

The built-in sidestand switch is part of the ignition circuit cut-off system, which cuts the ignition in certain situations. (See further down for an explanation of the ignition circuit cut-off system.)

EWA10171

## **WARNING**

- Do not exceed the load limit of 3 kg (6.6 lb) for the carrier.
- Do not exceed the maximum load of 190 kg (419 lb) for the vehicle.

EAU15301

## **WARNING**

The vehicle must not be ridden with the sidestand down, or if the sidestand cannot be properly moved up (or does not stay up), otherwise the sidestand could contact the ground and distract the operator, resulting in a possible loss of control. Yamaha's ignition circuit cut-off system has been designed to assist the operator in fulfilling the responsibility of raising the sidestand before starting off. Therefore, check this system regularly as described

EWA10240

# INSTRUMENT AND CONTROL FUNCTIONS

---

below and have a Yamaha dealer repair it if it does not function properly.

---

3

EAU43161

## Ignition circuit cut-off system

The ignition circuit cut-off system (comprising the sidestand switch, clutch switch and neutral switch) has the following functions.

- It prevents starting when the transmission is in gear and the sidestand is up, but the clutch lever is not pulled.
- It prevents starting when the transmission is in gear and the clutch lever is pulled, but the sidestand is still down.
- It cuts the running engine when the transmission is in gear and the sidestand is moved down.

Periodically check the operation of the ignition circuit cut-off system according to the following procedure.

EWA10260

### **WARNING**

---

- **The vehicle must be placed on the centerstand during this inspection.**
  - **If a malfunction is noted, have a Yamaha dealer check the system before riding.**
-



# INSTRUMENT AND CONTROL FUNCTIONS

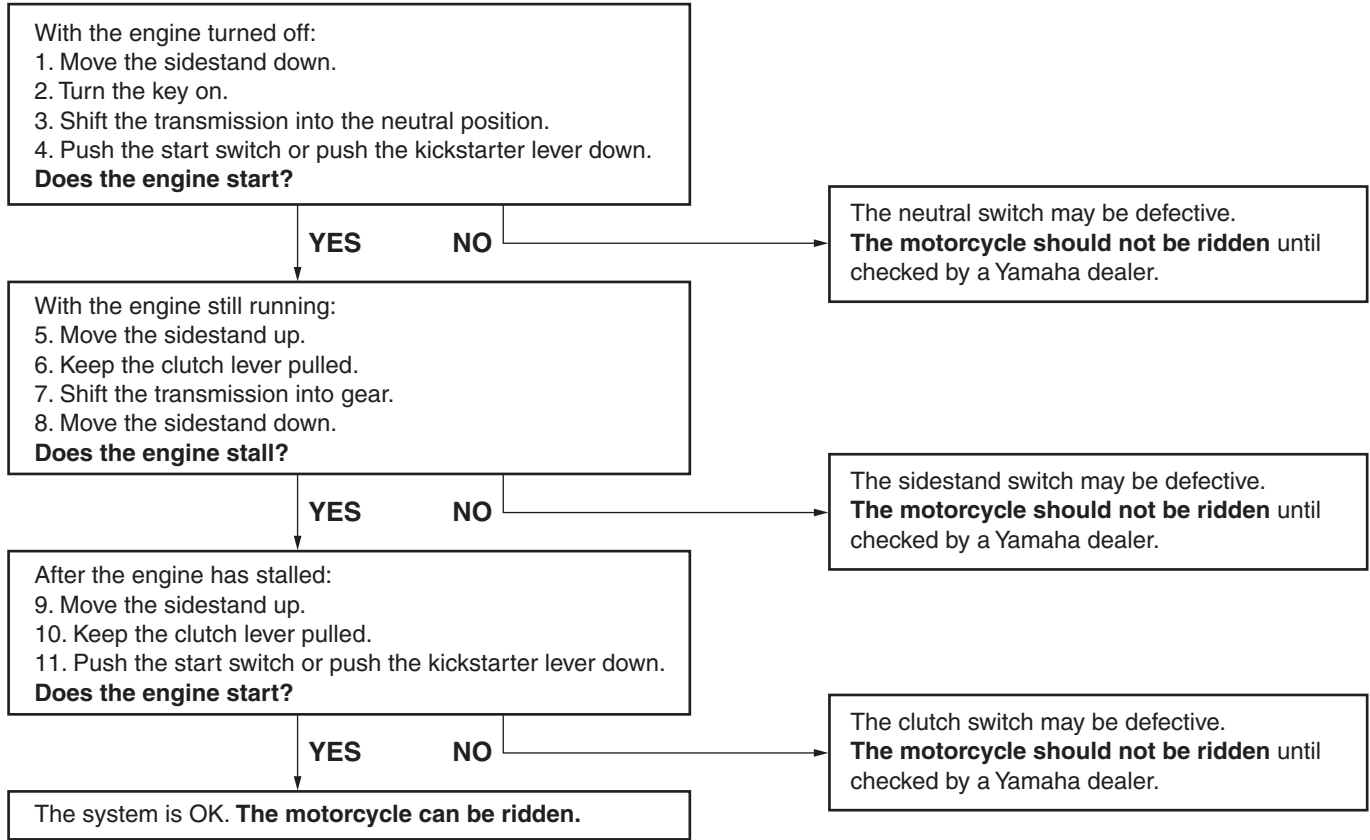

# PRE-OPERATION CHECKS

---

---

EAU15593

The condition of a vehicle is the owner's responsibility. Vital components can start to deteriorate quickly and unexpectedly, even if the vehicle remains unused (for example, as a result of exposure to the elements). Any damage, fluid leakage or loss of tire air pressure could have serious consequences. Therefore, it is very important, in addition to a thorough visual inspection, to check the following points before each ride.

## NOTE:

Pre-operation checks should be made each time the vehicle is used. Such an inspection can be accomplished in a very short time; and the added safety it assures is more than worth the time involved.

EWA11150

4



**If any item in the Pre-operation check list is not working properly, have it inspected and repaired before operating the vehicle.**

---

# PRE-OPERATION CHECKS

EAU15605

## Pre-operation check list

ITEM	CHECKS	PAGE
<b>Fuel</b>	<ul style="list-style-type: none"><li>• Check fuel level in fuel tank.</li><li>• Refuel if necessary.</li><li>• Check fuel line for leakage.</li></ul>	3-7
<b>Engine oil</b>	<ul style="list-style-type: none"><li>• Check oil level in engine.</li><li>• If necessary, add recommended oil to specified level.</li><li>• Check vehicle for oil leakage.</li></ul>	6-9
<b>Front brake</b>	<ul style="list-style-type: none"><li>• Check operation.</li><li>• If soft or spongy, have Yamaha dealer bleed hydraulic system.</li><li>• Check brake pads for wear.</li><li>• Replace if necessary.</li><li>• Check fluid level in reservoir.</li><li>• If necessary, add recommended brake fluid to specified level.</li><li>• Check hydraulic system for leakage.</li></ul>	6-19, 6-19
<b>Rear brake</b>	<ul style="list-style-type: none"><li>• Check operation.</li><li>• Check pedal free play.</li><li>• Adjust if necessary.</li></ul>	6-17, 6-19
<b>Clutch</b>	<ul style="list-style-type: none"><li>• Check operation.</li><li>• Lubricate cable if necessary.</li><li>• Check lever free play.</li><li>• Adjust if necessary.</li></ul>	6-16
<b>Throttle grip</b>	<ul style="list-style-type: none"><li>• Make sure that operation is smooth.</li><li>• Check cable free play.</li><li>• If necessary, have Yamaha dealer adjust cable free play and lubricate cable and grip housing.</li></ul>	6-12, 6-23
<b>Control cables</b>	<ul style="list-style-type: none"><li>• Make sure that operation is smooth.</li><li>• Lubricate if necessary.</li></ul>	6-23
<b>Drive chain</b>	<ul style="list-style-type: none"><li>• Check chain slack.</li><li>• Adjust if necessary.</li><li>• Check chain condition.</li><li>• Lubricate if necessary.</li></ul>	6-21, 6-22

# PRE-OPERATION CHECKS

ITEM	CHECKS	PAGE
<b>Wheels and tires</b>	<ul style="list-style-type: none"><li>• Check for damage.</li><li>• Check tire condition and tread depth.</li><li>• Check air pressure.</li><li>• Correct if necessary.</li></ul>	6-13, 6-15
<b>Shift pedal</b>	<ul style="list-style-type: none"><li>• Make sure that operation is smooth.</li><li>• Correct if necessary.</li></ul>	—
<b>Brake pedal</b>	<ul style="list-style-type: none"><li>• Make sure that operation is smooth.</li><li>• Lubricate pedal pivoting point if necessary.</li></ul>	6-24
<b>Brake and clutch levers</b>	<ul style="list-style-type: none"><li>• Make sure that operation is smooth.</li><li>• Lubricate lever pivoting points if necessary.</li></ul>	6-23
<b>Centerstand, sidestand</b>	<ul style="list-style-type: none"><li>• Make sure that operation is smooth.</li><li>• Lubricate pivots if necessary.</li></ul>	6-24
<b>Chassis fasteners</b>	<ul style="list-style-type: none"><li>• Make sure that all nuts, bolts and screws are properly tightened.</li><li>• Tighten if necessary.</li></ul>	—
<b>Instruments, lights, signals and switches</b>	<ul style="list-style-type: none"><li>• Check operation.</li><li>• Correct if necessary.</li></ul>	—
<b>Sidestand switch</b>	<ul style="list-style-type: none"><li>• Check operation of ignition circuit cut-off system.</li><li>• If system is defective, have Yamaha dealer check vehicle.</li></ul>	3-9

# OPERATION AND IMPORTANT RIDING POINTS

EAU15950

EAU45310

EAU43181

EWA10270

## **WARNING**

- **Become thoroughly familiar with all operating controls and their functions before riding. Consult a Yamaha dealer regarding any control or function that you do not thoroughly understand.**
- **Never start the engine or operate it in a closed area for any length of time. Exhaust fumes are poisonous, and inhaling them can cause loss of consciousness and death within a short time. Always make sure that there is adequate ventilation.**
- **Before starting out, make sure that the sidestand is up. If the sidestand is not raised completely, it could contact the ground and distract the operator, resulting in a possible loss of control.**

## **NOTE:** \_\_\_\_\_

This model is equipped with a lean angle sensor to stop the engine in case of a turnover. To start the engine after a turnover, be sure to turn the main switch to “OFF” and then to “ON”. Failing to do so will prevent the engine from starting even though the engine will crank when pushing the start switch.

## **Starting the engine**

In order for the ignition circuit cut-off system to enable starting, one of the following conditions must be met:

- The transmission is in the neutral position.
- The transmission is in gear with the clutch lever pulled and the sidestand up.

EWA10290

## **WARNING**

- **Before starting the engine, check the function of the ignition circuit cut-off system according to the procedure described on page 3-10.**
- **Never ride with the sidestand down.**

1. Turn the key to “ON”.
2. Shift the transmission into the neutral position.

## **NOTE:** \_\_\_\_\_

When the transmission is in the neutral position, the neutral indicator light should be on, otherwise have a Yamaha dealer check the electrical circuit.

# OPERATION AND IMPORTANT RIDING POINTS

3. Start the engine by pushing the start switch or by pushing the kick-starter lever down.

**NOTE:** \_\_\_\_\_

If the engine fails to start when using the start switch, release it, wait a few seconds, and then try again. Each starting attempt should be as short as possible to preserve the battery. Do not crank the engine more than 10 seconds on any one attempt. If the engine does not start with the starter motor, try using the kickstarter.

5

**CAUTION:** \_\_\_\_\_

The engine trouble warning light should come on when the key is turned to "ON", and then go off after a few seconds. If the engine trouble warning light comes on or flashes after starting, immediately stop the engine, and have a Yamaha dealer check the self-diagnosis system.

ECA11040

**CAUTION:** \_\_\_\_\_

For maximum engine life, never accelerate hard when the engine is cold!

ECA11370

EAU16671

## Shifting

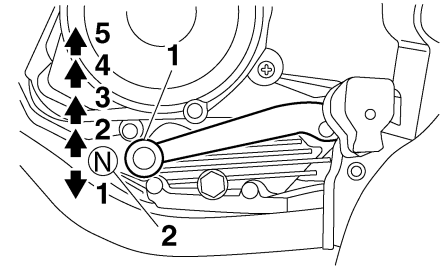

1. Shift pedal
2. Neutral position

Shifting gears lets you control the amount of engine power available for starting off, accelerating, climbing hills, etc.

The gear positions are shown in the illustration.

**NOTE:** \_\_\_\_\_

To shift the transmission into the neutral position, press the shift pedal down repeatedly until it reaches the end of its travel, and then slightly raise it.

## CAUTION:

- Even with the transmission in the neutral position, do not coast for long periods of time with the engine off, and do not tow the motorcycle for long distances. The transmission is properly lubricated only when the engine is running. Inadequate lubrication may damage the transmission.
- Always use the clutch while changing gears to avoid damaging the engine, transmission, and drive train, which are not designed to withstand the shock of forced shifting.

## Tips for reducing fuel consumption

Fuel consumption depends largely on your riding style. Consider the following tips to reduce fuel consumption:

- Shift up swiftly, and avoid high engine speeds during acceleration.
- Do not rev the engine while shifting down, and avoid high engine speeds with no load on the engine.
- Turn the engine off instead of letting it idle for an extended length of time (e.g., in traffic jams, at traffic lights or at railroad crossings).

## Engine break-in

There is never a more important period in the life of your engine than the period between 0 and 1000 km (600 mi). For this reason, you should read the following material carefully.

Since the engine is brand new, do not put an excessive load on it for the first 1000 km (600 mi). The various parts in the engine wear and polish themselves to the correct operating clearances. During this period, prolonged full-throttle operation or any condition that might result in engine overheating must be avoided.

## 0–500 km (0–300 mi)

Avoid prolonged operation above 6000 r/min.

After every hour of operation, stop the engine, and then let it cool for five to ten minutes.

Vary the engine speed from time to time. Do not operate the engine at one set throttle position.

# OPERATION AND IMPORTANT RIDING POINTS

---

## 500–1000 km (300–600 mi)

Avoid prolonged operation above 7500 r/min.

Rev the engine freely through the gears, but do not use full throttle at any time.

ECA10280

### CAUTION:

After 1000 km (600 mi) of operation, the engine oil must be changed.

## 1000 km (600 mi) and beyond

The vehicle can now be operated normally.

ECA10310

### CAUTION:

- Keep the engine speed out of the tachometer red zone.
- If any engine trouble should occur during the engine break-in period, immediately have a Yamaha dealer check the vehicle.

EAU17212

## Parking

When parking, stop the engine, and then remove the key from the main switch.

EWA10310

### WARNING

- Since the engine and exhaust system can become very hot, park in a place where pedestrians or children are not likely to touch them.
- Do not park on a slope or on soft ground, otherwise the vehicle may overturn.

ECA10380

### CAUTION:

Never park in an area where there are fire hazards such as grass or other flammable materials.



EAU17240

Safety is an obligation of the owner. Periodic inspection, adjustment and lubrication will keep your vehicle in the safest and most efficient condition possible. The most important points of inspection, adjustment, and lubrication are explained on the following pages. The intervals given in the periodic maintenance and lubrication chart should be simply considered as a general guide under normal riding conditions. However, DEPENDING ON THE WEATHER, TERRAIN, GEOGRAPHICAL LOCATION, AND INDIVIDUAL USE, THE MAINTENANCE INTERVALS MAY NEED TO BE SHORTENED.

EWA10320

## **! WARNING**

**If you are not familiar with maintenance work, have a Yamaha dealer do it for you.**

## Owner's tool kit

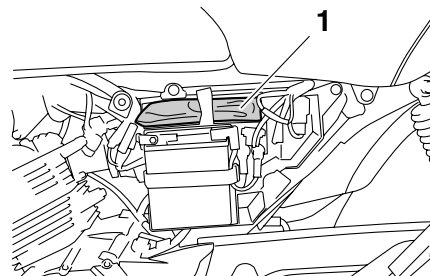

1. Owner's tool kit

The owner's tool kit is located behind panel A. (See page 6-6.)

The service information included in this manual and the tools provided in the owner's tool kit are intended to assist you in the performance of preventive maintenance and minor repairs. However, additional tools such as a torque wrench may be necessary to perform certain maintenance work correctly.

## **NOTE:**

If you do not have the tools or experience required for a particular job, have a Yamaha dealer perform it for you.

EAU17340

## **! WARNING**

**Modifications not approved by Yamaha may cause loss of performance and render the vehicle unsafe for use. Consult a Yamaha dealer before attempting any changes.**

EWA10350

# PERIODIC MAINTENANCE AND MINOR REPAIR

EAU17715

## Periodic maintenance and lubrication chart

### NOTE:

- The annual checks must be performed every year, except if a kilometer-based maintenance, or for the UK, a mileage-based maintenance, is performed instead.
- From 30000 km (17500 mi), repeat the maintenance intervals starting from 6000 km (3500 mi).
- Items marked with an asterisk should be performed by a Yamaha dealer as they require special tools, data and technical skills.

NO.	ITEM	CHECK OR MAINTENANCE JOB	ODOMETER READING					ANNUAL CHECK
			1000 km (600 mi)	6000 km (3500 mi)	12000 km (7000 mi)	18000 km (10500 mi)	24000 km (14000 mi)	
1	* Fuel line	<ul style="list-style-type: none"> <li>• Check fuel hoses for cracks or damage.</li> </ul>		√	√	√	√	√
2	Spark plug	<ul style="list-style-type: none"> <li>• Check condition.</li> <li>• Clean and regap.</li> </ul>		√		√		
		<ul style="list-style-type: none"> <li>• Replace.</li> </ul>			√		√	
3	* Valves	<ul style="list-style-type: none"> <li>• Check valve clearance.</li> <li>• Adjust.</li> </ul>		√	√	√	√	
4	Air filter element	<ul style="list-style-type: none"> <li>• Clean.</li> </ul>		√		√		
		<ul style="list-style-type: none"> <li>• Replace.</li> </ul>			√		√	
5	Clutch	<ul style="list-style-type: none"> <li>• Check operation.</li> <li>• Adjust.</li> </ul>	√	√	√	√	√	
6	* Front brake	<ul style="list-style-type: none"> <li>• Check operation, fluid level and vehicle for fluid leakage.</li> </ul>	√	√	√	√	√	√
		<ul style="list-style-type: none"> <li>• Replace brake pads.</li> </ul>	Whenever worn to the limit					

# PERIODIC MAINTENANCE AND MINOR REPAIR

NO.	ITEM	CHECK OR MAINTENANCE JOB	ODOMETER READING					ANNUAL CHECK
			1000 km (600 mi)	6000 km (3500 mi)	12000 km (7000 mi)	18000 km (10500 mi)	24000 km (14000 mi)	
7	* Rear brake	• Check operation and adjust brake pedal free play.	√	√	√	√	√	√
		• Replace brake shoes.	Whenever worn to the limit					
8	* Brake hose	• Check for cracks or damage.		√	√	√	√	√
		• Replace.	Every 4 years					
9	* Wheels	• Check runout and for damage.		√	√	√	√	
10	* Tires	<ul style="list-style-type: none"> <li>• Check tread depth and for damage.</li> <li>• Replace if necessary.</li> <li>• Check air pressure.</li> <li>• Correct if necessary.</li> </ul>		√	√	√	√	√
11	* Wheel bearings	• Check bearing for looseness or damage.		√	√	√	√	
12	* Swingarm pivot bushes	• Check bush assemblies for looseness.		√	√	√	√	
		• Lubricate with lithium-soap-based grease.	Every 50000 km (30000 mi)					
13	Drive chain	<ul style="list-style-type: none"> <li>• Check chain slack, alignment and condition.</li> <li>• Adjust and lubricate chain with a special O-ring chain lubricant thoroughly.</li> </ul>	Every 1000 km (600 mi) and after washing the motorcycle or riding in the rain					
14	* Steering bearings	• Check bearing play and steering for roughness.	√	√	√	√	√	
		• Lubricate with lithium-soap-based grease.	Every 24000 km (14000 mi)					

# PERIODIC MAINTENANCE AND MINOR REPAIR

NO.	ITEM	CHECK OR MAINTENANCE JOB	ODOMETER READING					ANNUAL CHECK
			1000 km (600 mi)	6000 km (3500 mi)	12000 km (7000 mi)	18000 km (10500 mi)	24000 km (14000 mi)	
15	* Chassis fasteners	• Make sure that all nuts, bolts and screws are properly tightened.		√	√	√	√	√
16	Brake lever pivot shaft	• Lubricate with silicone grease.		√	√	√	√	√
17	Brake pedal pivot shaft	• Lubricate with lithium-soap-based grease.		√	√	√	√	√
18	Clutch lever pivot shaft	• Lubricate with lithium-soap-based grease.		√	√	√	√	√
19	Sidestand, center-stand	• Check operation. • Lubricate.		√	√	√	√	√
20	* Sidestand switch	• Check operation.	√	√	√	√	√	√
21	* Front fork	• Check operation and for oil leakage.		√	√	√	√	
22	* Shock absorber assemblies	• Check operation and shock absorbers for oil leakage.		√	√	√	√	
23	* Fuel injection	• Check engine idle speed.	√	√	√	√	√	√
24	Engine oil	• Change. • Check oil level and vehicle for oil leakage.	√	√	√	√	√	√
25	* Front and rear brake switches	• Check operation.	√	√	√	√	√	√
26	Moving parts and cables	• Lubricate.		√	√	√	√	√

# PERIODIC MAINTENANCE AND MINOR REPAIR

NO.	ITEM	CHECK OR MAINTENANCE JOB	ODOMETER READING					ANNUAL CHECK
			1000 km (600 mi)	6000 km (3500 mi)	12000 km (7000 mi)	18000 km (10500 mi)	24000 km (14000 mi)	
27	* Throttle grip housing and cable	<ul style="list-style-type: none"> <li>• Check operation and free play.</li> <li>• Adjust the throttle cable free play if necessary.</li> <li>• Lubricate the throttle grip housing and cable.</li> </ul>		√	√	√	√	√
28	* Air induction system	<ul style="list-style-type: none"> <li>• Check the air cut-off valve, reed valve, and hose for damage.</li> <li>• Replace any damaged parts if necessary.</li> </ul>		√	√	√	√	√
29	* Lights, signals and switches	<ul style="list-style-type: none"> <li>• Check operation.</li> <li>• Adjust headlight beam.</li> </ul>	√	√	√	√	√	√

EAU18660

**NOTE:**

- The air filter needs more frequent service if you are riding in unusually wet or dusty areas.
- Hydraulic brake service
  - Regularly check and, if necessary, correct the brake fluid level.
  - Every two years replace the internal components of the brake master cylinder and caliper, and change the brake fluid.
  - Replace the brake hoses every four years and if cracked or damaged.

# PERIODIC MAINTENANCE AND MINOR REPAIR

## Removing and installing panels

EAU18771

The panels shown need to be removed to perform some of the maintenance jobs described in this chapter. Refer to this section each time a panel needs to be removed and installed.

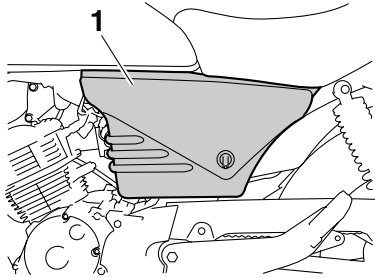

1. Panel A

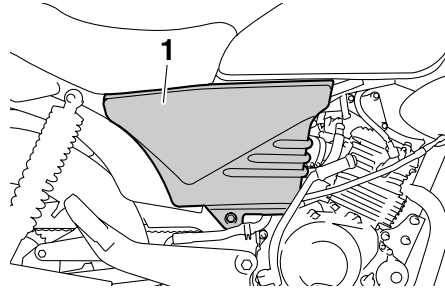

1. Panel B

### Panel A

EAU36961

#### To remove the panel

1. Slide the panel lock cover open, insert the key into the lock, and then turn it 1/4 turn clockwise.

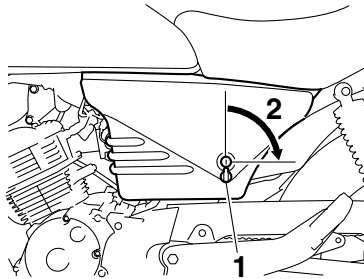

1. Panel lock cover
2. Unlock.

2. Pull the front of the panel out with the key inserted in the lock, and then slide the panel forward to release it in the rear.

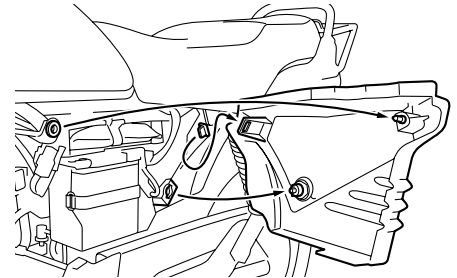

#### To install the panel

1. Secure the rear of the panel, and then push the front of the panel in with the key inserted in the lock.

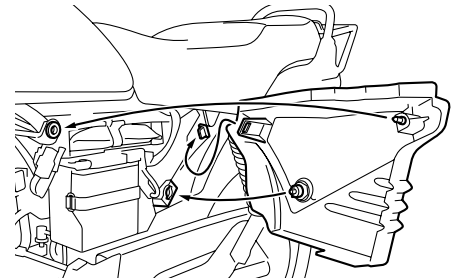

# PERIODIC MAINTENANCE AND MINOR REPAIR

2. While pushing the panel inward, turn the key counterclockwise to the original position, remove it, and then close the panel lock cover.

## Panel B

EAU37070

### To remove the panel

1. Remove the screw.

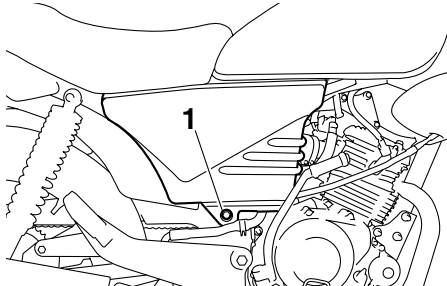

1. Screw

2. Pull the front of the panel out, and then slide the panel forward to release it in the rear.

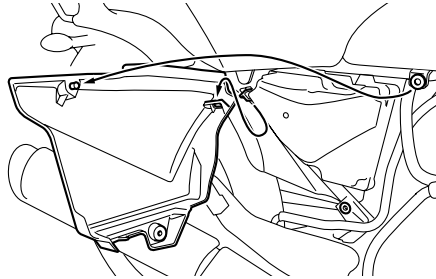

### To install the panel

1. Secure the rear of the panel, and then push the front of the panel in.

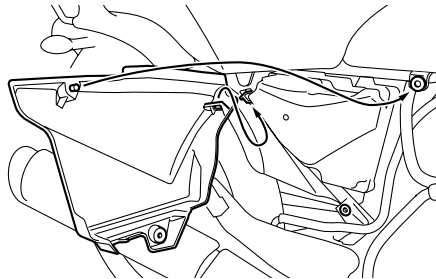

2. Install the screw.

## Checking the spark plug

EAU19603

The spark plug is an important engine component, which is easy to check. Since heat and deposits will cause any spark plug to slowly erode, the spark plug should be removed and checked in accordance with the periodic maintenance and lubrication chart. In addition, the condition of the spark plug can reveal the condition of the engine.

### To remove the spark plug

1. Remove the spark plug cap.

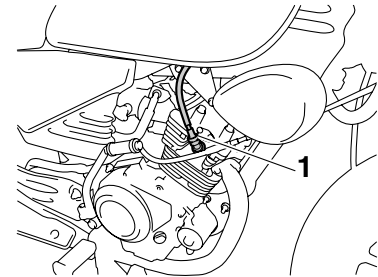

1. Spark plug cap

2. Remove the spark plug as shown, with the spark plug wrench included in the owner's tool kit.

# PERIODIC MAINTENANCE AND MINOR REPAIR

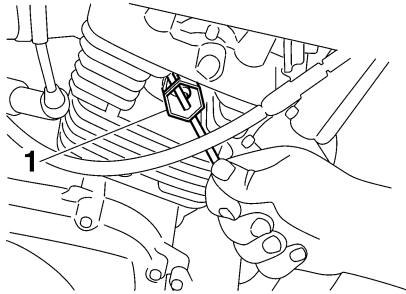

1. Spark plug wrench

## To check the spark plug

1. Check that the porcelain insulator around the center electrode of the spark plug is a medium-to-light tan (the ideal color when the vehicle is ridden normally).

### NOTE:

If the spark plug shows a distinctly different color, the engine could be operating improperly. Do not attempt to diagnose such problems yourself. Instead, have a Yamaha dealer check the vehicle.

2. Check the spark plug for electrode erosion and excessive carbon or other deposits, and replace it if necessary.

**Specified spark plug:**  
NGK/CR6HSA

## To install the spark plug

1. Measure the spark plug gap with a wire thickness gauge and, if necessary, adjust the gap to specification.

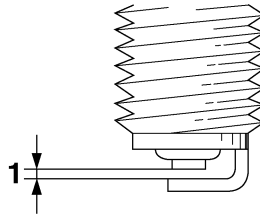

1. Spark plug gap

**Spark plug gap:**  
0.6–0.7 mm (0.024–0.028 in)

2. Clean the surface of the spark plug gasket and its mating surface, and then wipe off any grime from the spark plug threads.
3. Install the spark plug with the spark plug wrench, and then tighten it to the specified torque.

### Tightening torque:

Spark plug:  
12.5 Nm (1.25 m-kgf, 9.0 ft-lbf)

### NOTE:

If a torque wrench is not available when installing a spark plug, a good estimate of the correct torque is 1/4–1/2 turn past finger tight. However, the spark plug should be tightened to the specified torque as soon as possible.

4. Install the spark plug cap.



# PERIODIC MAINTENANCE AND MINOR REPAIR

EAU37171

## Engine oil

The engine oil level should be checked before each ride. In addition, the oil must be changed at the intervals specified in the periodic maintenance and lubrication chart.

### To check the engine oil level

1. Place the vehicle on the center-stand.

#### NOTE:

Make sure that the vehicle is positioned straight up when checking the oil level. A slight tilt to the side can result in a false reading.

2. Start the engine, warm it up for several minutes, and then turn it off.
3. Wait a few minutes until the oil settles, remove the oil filler cap, wipe the dipstick clean, insert it back into the oil filler hole (without screwing it in), and then remove it again to check the oil level.

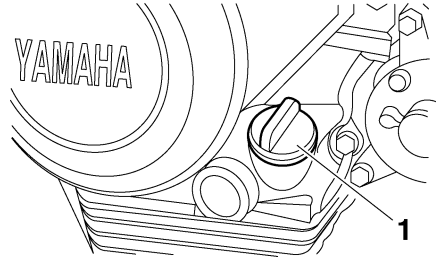

1. Engine oil filler cap

#### NOTE:

The engine oil should be between the minimum and maximum level marks.

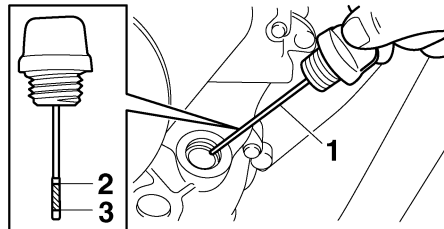

1. Dipstick
2. Maximum level mark
3. Minimum level mark

4. If the engine oil is at or below the minimum level mark, add sufficient oil of the recommended type to raise it to the correct level.
5. Insert the dipstick into the oil filler hole, and then tighten the oil filler cap.

### To change the engine oil

1. Start the engine, warm it up for several minutes, and then turn it off.
2. Place an oil pan under the engine to collect the used oil.
3. Remove the engine oil filler cap and drain bolt to drain the oil from the crankcase.

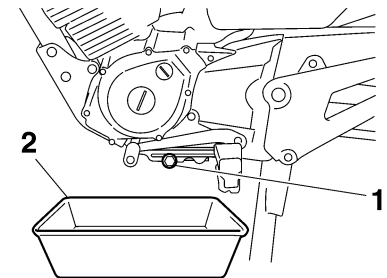

1. Engine oil drain bolt
2. Oil pan

# PERIODIC MAINTENANCE AND MINOR REPAIR

4. Install the engine oil drain bolt, and then tighten it to the specified torque.

## Tightening torque:

Engine oil drain bolt:  
20 Nm (2.0 m·kgf, 14 ft·lbf)

5. Refill with the specified amount of the recommended engine oil, and then install and tighten the engine oil filler cap.

Recommended engine oil:  
See page 8-1.

Oil change quantity:  
1.00 L (1.06 US qt, 0.88 Imp.qt)

ECA11620

## CAUTION:

- In order to prevent clutch slippage (since the engine oil also lubricates the clutch), do not mix any chemical additives. Do not use oils with a diesel specification of “CD” or oils of a higher quality than specified. In addition, do not use oils labeled “ENERGY CONSERVING II” or higher.

- Make sure that no foreign material enters the crankcase.

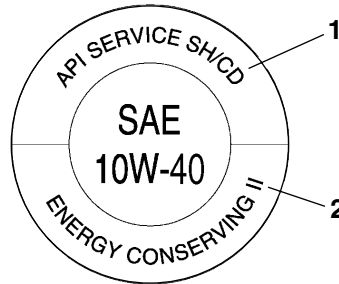

1. “CD” specification
2. “ENERGY CONSERVING II”

6. Start the engine, and then let it idle for several minutes while checking it for oil leakage. If oil is leaking, immediately turn the engine off and check for the cause.
7. Turn the engine off, and then check the oil level and correct it if necessary.

EAU37121

## Cleaning the air filter element

The air filter element should be cleaned at the intervals specified in the periodic maintenance and lubrication chart. Clean the air filter element more frequently if you are riding in unusually wet or dusty areas.

1. Remove panel B. (See page 6-6.)
2. Remove the air filter case cover by removing the screws.

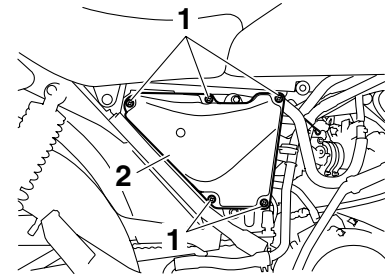

1. Screw
2. Air filter case cover

3. Remove the air filter element.

# PERIODIC MAINTENANCE AND MINOR REPAIR

EWA10430

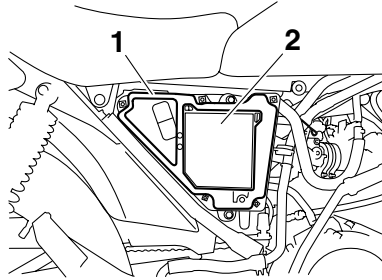

1. Air filter element
2. Sponge material

4. Remove the sponge material from the air filter element.
5. Lightly tap the air filter element to remove most of the dust and dirt, and then blow the remaining dirt out with compressed air on the mesh side as shown. If the air filter element is damaged, replace it.

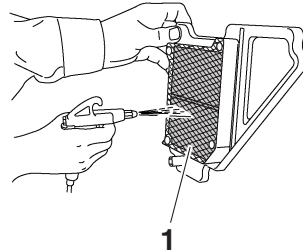

1. Air filter element

6. Clean the sponge material with solvent, then squeeze the remaining solvent out, and be sure to let the sponge material dry before installing it into the air filter element. If the sponge material is damaged, replace it.

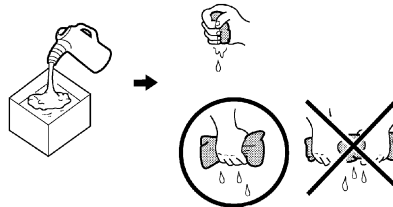

## **WARNING**

Use only a dedicated parts cleaning solvent. To avoid the risk of fire or explosion, do not use gasoline or solvents with a low flash point.

ECA15100

## **CAUTION:**

To avoid damaging the sponge material, handle it gently and carefully, and do not twist it.

7. Install the sponge material into the air filter element, and then install the air filter element into the air filter case.

ECA10480

## **CAUTION:**

- Make sure that the air filter element is properly seated in the air filter case.
- The engine should never be operated without the air filter element installed, otherwise the piston(s) and/or cylinder(s) may become excessively worn.

8. Install the air filter case cover by installing the screws.

# PERIODIC MAINTENANCE AND MINOR REPAIR

9. Check the hose at the bottom of the air filter case for accumulated dust or water, and if necessary, drain it by removing the clamp, and then removing the plug.

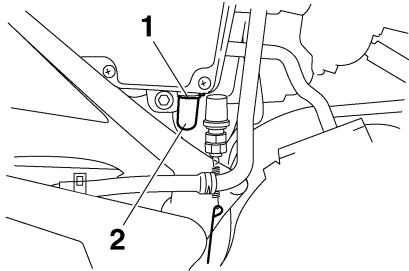

1. Clamp
2. Air filter check hose plug

10. Install the plug into the check hose, and then install the clamp.
11. Install the panel.

## Checking the engine idling speed

EAU44730

The engine idling speed must be checked as follows and, if necessary, adjusted by a Yamaha dealer at the intervals specified in the periodic maintenance and lubrication chart. Start the engine and warm it up for several minutes at 1000–2000 r/min while occasionally revving it to 4000–5000 r/min.

**Engine idling speed:**  
1300–1500 r/min

## Adjusting the throttle cable free play

EAU21370

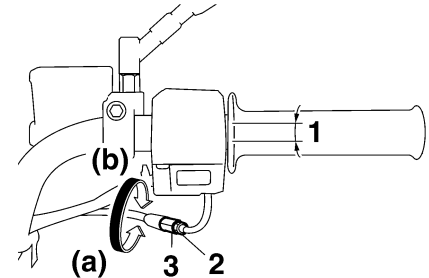

1. Throttle cable free play
2. Locknut
3. Throttle cable free play adjusting nut

The throttle cable free play should measure 3.0–7.0 mm (0.12–0.28 in) at the throttle grip. Periodically check the throttle cable free play and, if necessary, adjust it as follows.

### NOTE: \_\_\_\_\_

The engine idling speed must be correctly adjusted before checking and adjusting the throttle cable free play.

1. Loosen the locknut.

# PERIODIC MAINTENANCE AND MINOR REPAIR

2. To increase the throttle cable free play, turn the adjusting nut in direction (a). To decrease the throttle cable free play, turn the adjusting nut in direction (b).
3. Tighten the locknut.

## Valve clearance

The valve clearance changes with use, resulting in improper air-fuel mixture and/or engine noise. To prevent this from occurring, the valve clearance must be adjusted by a Yamaha dealer at the intervals specified in the periodic maintenance and lubrication chart.

EAU21401

## Tires

To maximize the performance, durability, and safe operation of your motorcycle, note the following points regarding the specified tires.

EAU21561

## Tire air pressure

The tire air pressure should be checked and, if necessary, adjusted before each ride.

EWA10500

### **WARNING**

- The tire air pressure must be checked and adjusted on cold tires (i.e., when the temperature of the tires equals the ambient temperature).
- The tire air pressure must be adjusted in accordance with the riding speed and with the total weight of rider, passenger, cargo, and accessories approved for this model.

# PERIODIC MAINTENANCE AND MINOR REPAIR

## Tire air pressure (measured on cold tires):

### 0–90 kg (0–198 lb):

Front:

175 kPa (1.75 kgf/cm<sup>2</sup>, 25 psi)

Rear:

200 kPa (2.00 kgf/cm<sup>2</sup>, 29 psi)

### 90–190 kg (198–419 lb):

Front:

175 kPa (1.75 kgf/cm<sup>2</sup>, 25 psi)

Rear:

280 kPa (2.80 kgf/cm<sup>2</sup>, 41 psi)

## Maximum load\*:

190 kg (419 lb)

\* Total weight of rider, passenger, cargo and accessories

EWA11020

## WARNING

Because loading has an enormous impact on the handling, braking, performance and safety characteristics of your motorcycle, you should keep the following precautions in mind.

- **NEVER OVERLOAD THE MOTORCYCLE!** Operation of an overloaded motorcycle may result in tire damage, loss of control, or severe injury. Make sure that the total weight of rider,

passenger, cargo, and accessories does not exceed the specified maximum load for the vehicle.

- Do not carry along loosely packed items, which can shift during a ride.
- Securely pack the heaviest items close to the center of the motorcycle and distribute the weight evenly on both sides.
- Adjust the suspension and tire air pressure with regard to the load.
- Check the tire condition and air pressure before each ride.

## Tire inspection

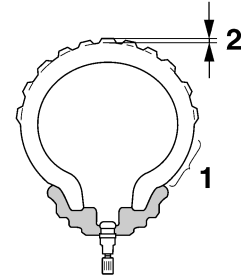

1. Tire sidewall
2. Tire tread depth

The tires must be checked before each ride. If the center tread depth reaches the specified limit, if the tire has a nail or glass fragments in it, or if the sidewall is cracked, have a Yamaha dealer replace the tire immediately.

**Minimum tire tread depth (front and rear):**  
1.6 mm (0.06 in)

## NOTE:

The tire tread depth limits may differ from country to country. Always comply with the local regulations.

# PERIODIC MAINTENANCE AND MINOR REPAIR

## Tire information

This motorcycle is equipped with cast wheels and tubeless tires.

EWA10460

### WARNING

- The front and rear tires should be of the same make and design, otherwise the handling characteristics of the vehicle cannot be guaranteed.
- After extensive tests, only the tires listed below have been approved for this model by Yamaha Motor Co., Ltd.

#### Front tire:

Size:

3.00-18 47P

Manufacturer/model:

CHENG SHIN/C-6039

#### Rear tire:

Size:

3.50-16 58P

Manufacturer/model:

CHENG SHIN/C-289

EWA10470

### WARNING

- Have a Yamaha dealer replace excessively worn tires. Besides being illegal, operating the vehicle with excessively worn tires decreases riding stability and can lead to loss of control.
- The replacement of all wheel and brake related parts, including the tires, should be left to a Yamaha dealer, who has the necessary professional knowledge and experience.

EAU21960

## Cast wheels

To maximize the performance, durability, and safe operation of your vehicle, note the following points regarding the specified wheels.

- The wheel rims should be checked for cracks, bends or warpage before each ride. If any damage is found, have a Yamaha dealer replace the wheel. Do not attempt even the smallest repair to the wheel. A deformed or cracked wheel must be replaced.
- The wheel should be balanced whenever either the tire or wheel has been changed or replaced. An unbalanced wheel can result in poor performance, adverse handling characteristics, and a shortened tire life.
- Ride at moderate speeds after changing a tire since the tire surface must first be “broken in” for it to develop its optimal characteristics.

# PERIODIC MAINTENANCE AND MINOR REPAIR

EAU22032

## Adjusting the clutch lever free play

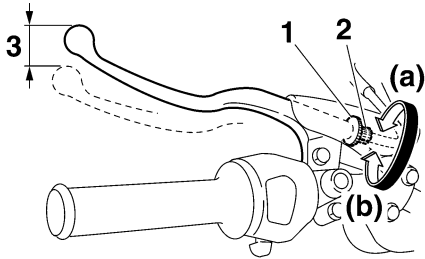

1. Locknut (clutch lever)
2. Clutch lever free play adjusting bolt
3. Clutch lever free play

The clutch lever free play should measure 10.0–15.0 mm (0.39–0.59 in) as shown. Periodically check the clutch lever free play and, if necessary, adjust it as follows.

1. Loosen the locknut at the clutch lever.
2. To increase the clutch lever free play, turn the clutch lever free play adjusting bolt in direction (a). To decrease the clutch lever free play, turn the adjusting bolt in direction (b).

3. If the specified clutch lever free play could be obtained as described above, tighten the locknut and skip the rest of the procedure, otherwise, proceed as follows.
4. Fully turn the adjusting bolt in direction (a) to loosen the clutch cable.
5. Loosen the locknut further down the clutch cable.

7. Tighten both locknuts.

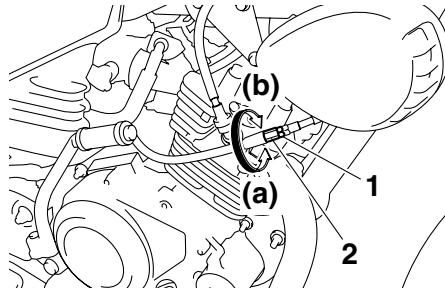

1. Locknut (clutch cable)
2. Clutch lever free play adjusting nut (clutch cable)

6. To increase the clutch lever free play, turn the clutch lever free play adjusting nut in direction (a). To decrease the clutch lever free play, turn the adjusting nut in direction (b).



# PERIODIC MAINTENANCE AND MINOR REPAIR

## Checking the front brake lever free play

EAUT1221

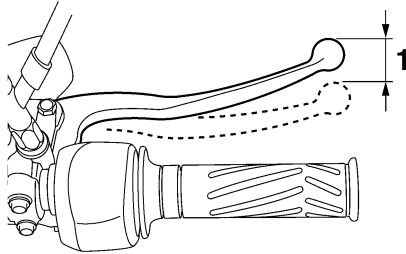

### 1. Brake lever free play

The brake lever free play should measure 0.0–7.0 mm (0.00–0.28 in) as shown. Periodically check the brake lever free play and, if necessary, have a Yamaha dealer check the brake system.

EWA10641

### WARNING

**An incorrect brake lever free play indicates a hazardous condition in the brake system. Do not operate the vehicle until the brake system has been checked or repaired by a Yamaha dealer.**

## Adjusting the brake pedal free play

EAU39812

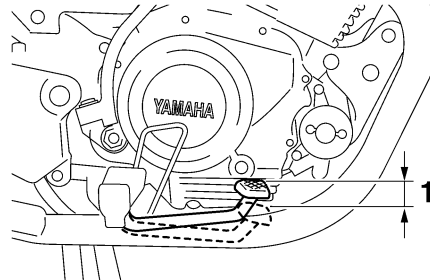

### 1. Brake pedal free play

The brake pedal free play should measure 20.0–30.0 mm (0.79–1.18 in) at the brake pedal end as shown. Periodically check the brake pedal free play and, if necessary, adjust it as follows. To increase the brake pedal free play, turn the adjusting nut at the brake rod in direction (a). To decrease the brake pedal free play, turn the adjusting nut in direction (b).

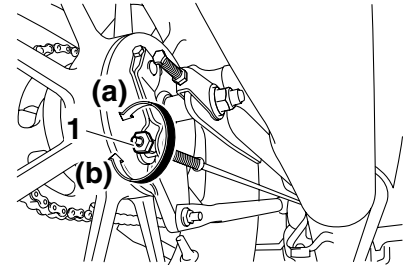

### 1. Brake pedal free play adjusting nut

EWA10680

### WARNING

- After adjusting the drive chain slack or removing and installing the rear wheel, always check the brake pedal free play.
- If proper adjustment cannot be obtained as described, have a Yamaha dealer make this adjustment.
- After adjusting the brake pedal free play, check the operation of the brake light.

# PERIODIC MAINTENANCE AND MINOR REPAIR

## Checking the shift pedal

EAU44820

The operation of the shift pedal should be checked before each ride. If operation is not smooth, have a Yamaha dealer check the vehicle.

## Adjusting the rear brake light switch

EAU22291

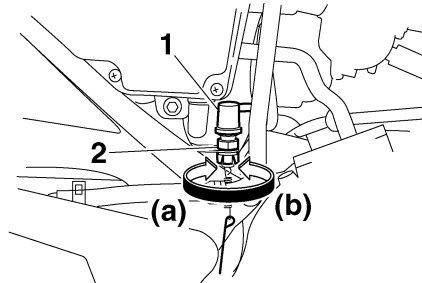

1. Rear brake light switch
2. Rear brake light switch adjusting nut

The rear brake light switch, which is activated by the brake pedal, is properly adjusted when the brake light comes on just before braking takes effect. If necessary, adjust the brake light switch as follows.

1. Remove panel B. (See page 6-6.)
2. Turn the adjusting nut while holding the rear brake light switch in place. To make the brake light come on earlier, turn the adjusting nut in direction (a). To make the brake light come on later, turn the adjusting nut in direction (b).

3. Install the panel.

# PERIODIC MAINTENANCE AND MINOR REPAIR

## Checking the front brake pads and rear brake shoes

EAU22380

The front brake pads and the rear brake shoes must be checked for wear at the intervals specified in the periodic maintenance and lubrication chart.

### Front brake pads

EAU22430

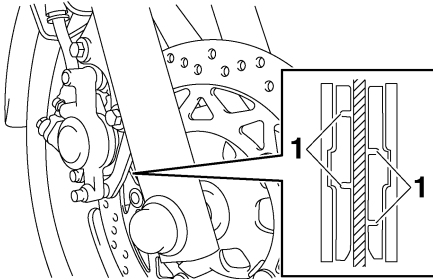

1. Brake pad wear indicator groove

Each front brake pad is provided with wear indicator grooves, which allow you to check the brake pad wear without having to disassemble the brake. To check the brake pad wear, check the wear indicator grooves. If a brake pad has worn to the point that the wear

indicator grooves have almost disappeared, have a Yamaha dealer replace the brake pads as a set.

### Rear brake shoes

EAU43170

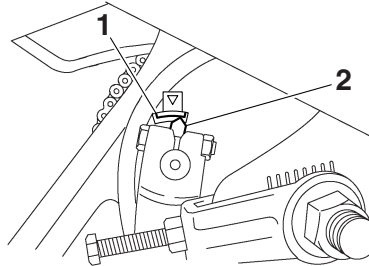

1. Brake shoe wear limit mark
2. Brake shoe wear indicator

The rear brake is provided with a wear indicator, which allows you to check the brake shoe wear without having to disassemble the brake. To check the brake shoe wear, check the position of the wear indicator while applying the brake. If a brake shoe has worn to the point that the wear indicator reaches the wear limit mark, have a Yamaha dealer replace the brake shoes as a set.

## Checking the front brake fluid level

EAU37001

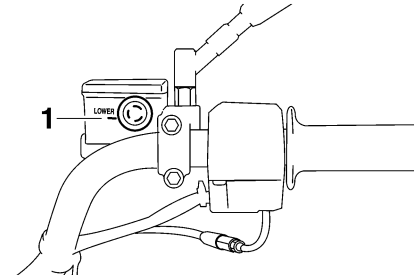

1. Minimum level mark

Insufficient brake fluid may allow air to enter the brake system, possibly causing it to become ineffective.

Before riding, check that the brake fluid is above the minimum level mark and replenish if necessary. A low brake fluid level may indicate worn brake pads and/or brake system leakage. If the brake fluid level is low, be sure to check the brake pads for wear and the brake system for leakage.

Observe these precautions:

# PERIODIC MAINTENANCE AND MINOR REPAIR

- When checking the fluid level, make sure that the top of the master cylinder is level by turning the handlebars.
- Use only the recommended quality brake fluid, otherwise the rubber seals may deteriorate, causing leakage and poor braking performance.

**Recommended brake fluid:**  
DOT 4

**NOTE:** \_\_\_\_\_

If DOT 4 is not available, DOT 3 can be used.

- Refill with the same type of brake fluid. Mixing fluids may result in a harmful chemical reaction and lead to poor braking performance.
- Be careful that water does not enter the master cylinder when refilling. Water will significantly lower the boiling point of the fluid and may result in vapor lock.

- Brake fluid may deteriorate painted surfaces or plastic parts. Always clean up spilled fluid immediately.
- As the brake pads wear, it is normal for the brake fluid level to gradually go down. However, if the brake fluid level goes down suddenly, have a Yamaha dealer check the cause.

## Changing the brake fluid

EAU22720

Have a Yamaha dealer change the brake fluid at the intervals specified in the NOTE after the periodic maintenance and lubrication chart. In addition, have the oil seals of the brake master cylinder and caliper as well as the brake hose replaced at the intervals listed below or whenever they are damaged or leaking.

- Oil seals: Replace every two years.
- Brake hose: Replace every four years.

# PERIODIC MAINTENANCE AND MINOR REPAIR

## Drive chain slack

EAU22760

The drive chain slack should be checked before each ride and adjusted if necessary.

## To check the drive chain slack

EAU22793

1. Place the motorcycle on the centerstand.
2. Shift the transmission into the neutral position.
3. Spin the rear wheel several times to locate the tightest portion of the drive chain.
4. Measure the drive chain slack as shown.

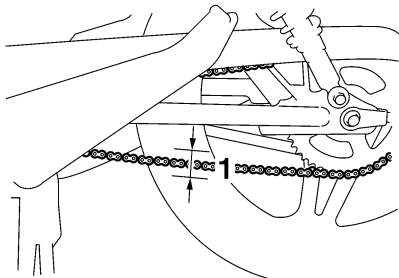

1. Drive chain slack

## Drive chain slack:

20.0–30.0 mm (0.79–1.18 in)

5. If the drive chain slack is incorrect, adjust it as follows.

## To adjust the drive chain slack

EAU37112

1. Loosen the brake pedal free play adjusting nut, brake torque rod nut, and axle nut.

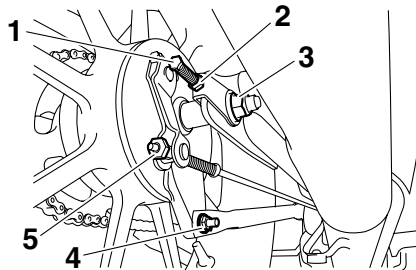

1. Drive chain slack adjusting bolt
2. Chain puller locknut
3. Axle nut
4. Brake torque rod nut
5. Brake pedal free play adjusting nut

2. Loosen the chain puller locknut at each end of the swingarm.

3. To tighten the drive chain, turn the adjusting bolt at each end of the swingarm in direction (a). To loosen the drive chain, turn the adjusting bolt at each end of the swingarm in direction (b), and then push the rear wheel forward.

## NOTE:

Using the alignment marks on each side of the swingarm, make sure that both chain pullers are in the same position for proper wheel alignment.

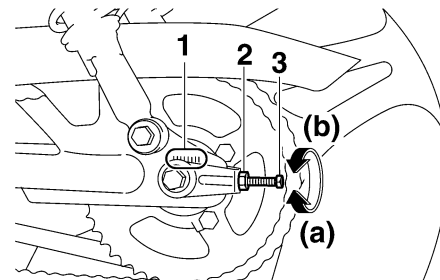

1. Alignment marks
2. Chain puller locknut
3. Drive chain slack adjusting bolt

# PERIODIC MAINTENANCE AND MINOR REPAIR

ECA10570

## CAUTION:

Improper drive chain slack will overload the engine as well as other vital parts of the motorcycle and can lead to chain slippage or breakage. To prevent this from occurring, keep the drive chain slack within the specified limits.

4. Tighten both locknuts, and then tighten the axle nut and brake torque rod nut to their specified torques.

### Tightening torques:

Axle nut:

80 Nm (8.0 m·kgf, 58 ft·lbf)

Brake torque rod nut:

19 Nm (1.9 m·kgf, 13 ft·lbf)

5. Adjust the brake pedal free play. (See page 6-17.)

EWA10660

## WARNING

After adjusting the brake pedal free play, check the operation of the brake light.

EAU23022

## Cleaning and lubricating the drive chain

The drive chain must be cleaned and lubricated at the intervals specified in the periodic maintenance and lubrication chart, otherwise it will quickly wear out, especially when riding in dusty or wet areas. Service the drive chain as follows.

ECA10581

## CAUTION:

The drive chain must be lubricated after washing the motorcycle and riding in the rain.

1. Clean the drive chain with kerosene and a small soft brush.

ECA11120

## CAUTION:

To prevent damaging the O-rings, do not clean the drive chain with steam cleaners, high-pressure washers or inappropriate solvents.

2. Wipe the drive chain dry.
3. Thoroughly lubricate the drive chain with a special O-ring chain lubricant.

ECA11110

## CAUTION:

Do not use engine oil or any other lubricants for the drive chain, as they may contain substances that could damage the O-rings.

# PERIODIC MAINTENANCE AND MINOR REPAIR

## Checking and lubricating the cables

EAU23100

The operation of all control cables and the condition of the cables should be checked before each ride, and the cables and cable ends should be lubricated if necessary. If a cable is damaged or does not move smoothly, have a Yamaha dealer check or replace it.

**Recommended lubricant:**  
Engine oil

EWA10720

### **WARNING**

Damage to the outer sheath may interfere with proper cable operation and will cause the inner cable to rust. Replace a damaged cable as soon as possible to prevent unsafe conditions.

## Checking and lubricating the throttle grip and cable

EAU23111

The operation of the throttle grip should be checked before each ride. In addition, the cable should be lubricated at the intervals specified in the periodic maintenance chart.

## Checking and lubricating the brake and clutch levers

EAU23142

### Brake lever

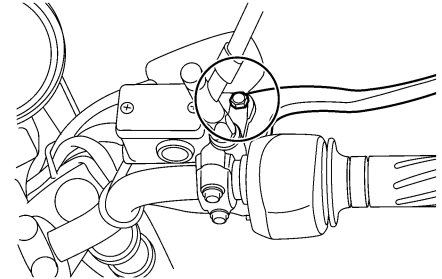

### Clutch lever

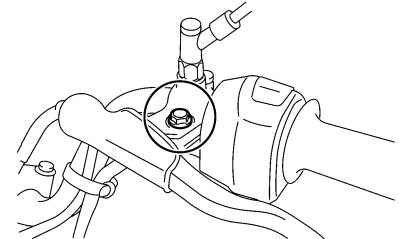

The operation of the brake and clutch levers should be checked before each ride, and the lever pivots should be lubricated if necessary.

# PERIODIC MAINTENANCE AND MINOR REPAIR

## Recommended lubricants:

- Brake lever:
  - Silicone grease
- Clutch lever:
  - Lithium-soap-based grease

## Checking and lubricating the brake pedal

EAU23182

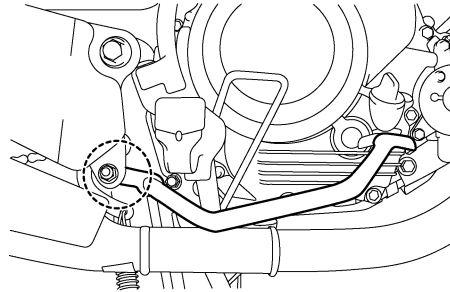

The operation of the brake pedal should be checked before each ride, and the pedal pivot should be lubricated if necessary.

**Recommended lubricant:**  
Lithium-soap-based grease

## Checking and lubricating the centerstand and sidestand

EAU23212

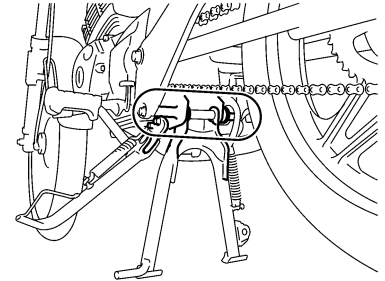

The operation of the centerstand and sidestand should be checked before each ride, and the pivots and metal-to-metal contact surfaces should be lubricated if necessary.

## **⚠ WARNING**

**If the centerstand or sidestand does not move up and down smoothly, have a Yamaha dealer check or repair it.**

**Recommended lubricant:**  
Lithium-soap-based grease

EWA10740



# PERIODIC MAINTENANCE AND MINOR REPAIR

## Lubricating the swingarm pivots

EAM1650

The swingarm pivots must be lubricated at the intervals specified in the periodic maintenance and lubrication chart.

**Recommended lubricant:**  
Lithium-soap-based grease

## Checking the front fork

EAU23271

The condition and operation of the front fork must be checked as follows at the intervals specified in the periodic maintenance and lubrication chart.

### To check the condition

EWA10750



**Securely support the vehicle so that there is no danger of it falling over.**

Check the inner tubes for scratches, damage and excessive oil leakage.

### To check the operation

1. Place the vehicle on a level surface and hold it in an upright position.
2. While applying the front brake, push down hard on the handlebars several times to check if the front fork compresses and rebounds smoothly.

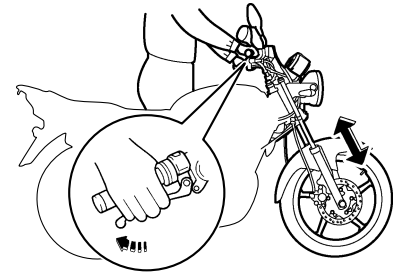

ECA10590

### **CAUTION:**

**If any damage is found or the front fork does not operate smoothly, have a Yamaha dealer check or repair it.**

# PERIODIC MAINTENANCE AND MINOR REPAIR

EAU23280

## Checking the steering

Worn or loose steering bearings may cause danger. Therefore, the operation of the steering must be checked as follows at the intervals specified in the periodic maintenance and lubrication chart.

1. Place a stand under the engine to raise the front wheel off the ground.

EWA10750

### **WARNING**

**Securely support the vehicle so that there is no danger of it falling over.**

2. Hold the lower ends of the front fork legs and try to move them forward and backward. If any free play can be felt, have a Yamaha dealer check or repair the steering.

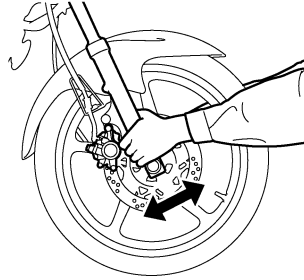

EAU23290

## Checking the wheel bearings

The front and rear wheel bearings must be checked at the intervals specified in the periodic maintenance and lubrication chart. If there is play in the wheel hub or if the wheel does not turn smoothly, have a Yamaha dealer check the wheel bearings.

# PERIODIC MAINTENANCE AND MINOR REPAIR

## Battery

EAU23380

EWA10760

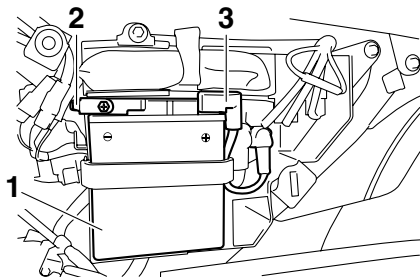

1. Battery
2. Negative battery lead (black)
3. Positive battery lead (red)

The battery is located behind panel A. (See page 6-6.)

This model is equipped with a sealed-type (MF) battery, which does not require any maintenance. There is no need to check the electrolyte or to add distilled water.

ECA10620

### CAUTION:

**Never attempt to remove the battery cell seals, as this would permanently damage the battery.**

### ⚠ WARNING

- **Electrolyte is poisonous and dangerous since it contains sulfuric acid, which causes severe burns. Avoid any contact with skin, eyes or clothing and always shield your eyes when working near batteries. In case of contact, administer the following FIRST AID.**
  - **EXTERNAL:** Flush with plenty of water.
  - **INTERNAL:** Drink large quantities of water or milk and immediately call a physician.
  - **EYES:** Flush with water for 15 minutes and seek prompt medical attention.
- **Batteries produce explosive hydrogen gas. Therefore, keep sparks, flames, cigarettes, etc., away from the battery and provide sufficient ventilation when charging it in an enclosed space.**

- **KEEP THIS AND ALL BATTERIES OUT OF THE REACH OF CHILDREN.**

### To charge the battery

Have a Yamaha dealer charge the battery as soon as possible if it seems to have discharged. Keep in mind that the battery tends to discharge more quickly if the vehicle is equipped with optional electrical accessories.

### To store the battery

1. If the vehicle will not be used for more than one month, remove the battery, fully charge it, and then place it in a cool, dry place.
2. If the battery will be stored for more than two months, check it at least once a month and fully charge it if necessary.
3. Fully charge the battery before installation.
4. After installation, make sure that the battery leads are properly connected to the battery terminals.

# PERIODIC MAINTENANCE AND MINOR REPAIR

ECA10630

EAU43211

## CAUTION:

- Always keep the battery charged. Storing a discharged battery can cause permanent battery damage.
- To charge a sealed-type (MF) battery, a special (constant-voltage) battery charger is required. Using a conventional battery charger will damage the battery. If you do not have access to a sealed-type (MF) battery charger, have a Yamaha dealer charge your battery.

## Replacing the fuse

The fuse is located behind panel A. (See page 6-6.)

To access the fuse, remove the starter relay coupler.

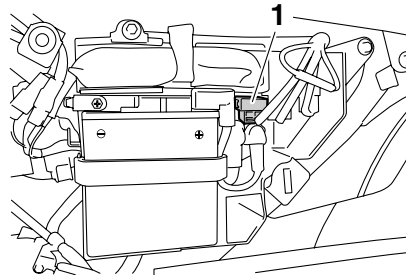

1. Starter relay coupler

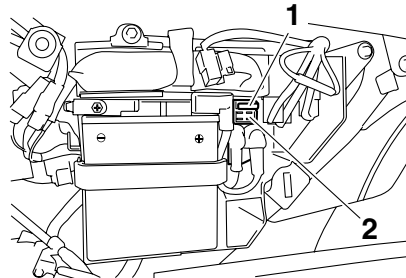

1. Fuse  
2. Starter relay

The spare fuse is located on the rear of the starter relay holder.

To access the spare fuse, remove the starter relay (together with its holder) by pulling it out, then turn the starter relay over.

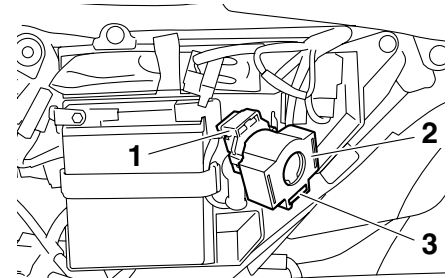

1. Starter relay  
2. Starter relay holder  
3. Spare fuse

If the fuse is blown, replace it as follows.

1. Turn the key to "OFF" and turn off all electrical circuits.
2. Remove the blown fuse, and then install a new fuse of the specified amperage.

**Specified fuse:**  
15.0 A

# PERIODIC MAINTENANCE AND MINOR REPAIR

ECA10640

EAU43190

## CAUTION:

Do not use a fuse of a higher amperage rating than recommended to avoid causing extensive damage to the electrical system and possibly a fire.

3. Turn the key to "ON" and turn on the electrical circuits to check if the devices operate.
4. If the fuse immediately blows again, have a Yamaha dealer check the electrical system.

## Replacing the headlight bulb

This model is equipped with a quartz bulb headlight. If the headlight bulb burns out, replace it as follows.

1. Remove the headlight unit by removing the screws.

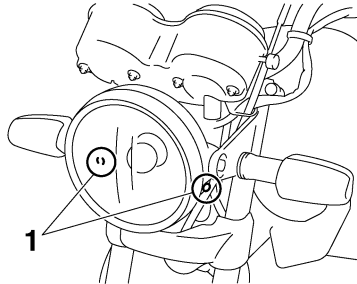

1. Screw

2. Remove the headlight bulb socket cover.

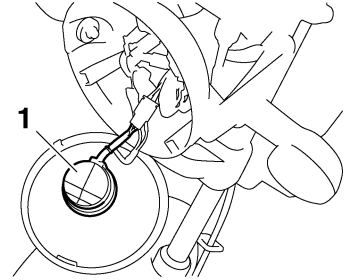

1. Headlight bulb socket cover

3. Remove the headlight bulb socket (together with the bulb) by turning it counterclockwise.

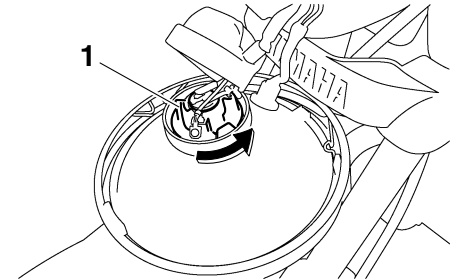

1. Headlight bulb socket

4. Remove the defective bulb by pushing it in and turning it counterclockwise.

# PERIODIC MAINTENANCE AND MINOR REPAIR

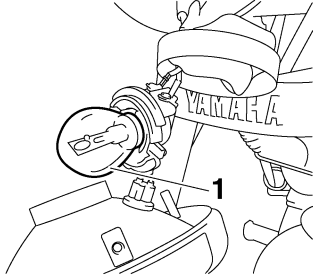

1. Headlight bulb

EWA10790

## **⚠ WARNING**

Headlight bulbs get very hot. Therefore, keep flammable products away from a lit headlight bulb, and do not touch the bulb until it has cooled down.

5. Insert a new bulb into the socket, push it in, and then turn it clockwise until it stops.

ECA10660

## **CAUTION:**

Do not touch the glass part of the headlight bulb to keep it free from oil, otherwise the transparency of the glass, the luminosity of the bulb, and the bulb life will be adversely af-

ected. Thoroughly clean off any dirt and fingerprints on the headlight bulb using a cloth moistened with alcohol or thinner.

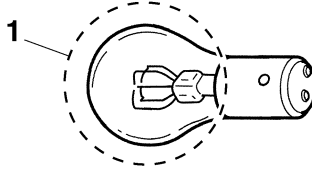

1. Do not touch the glass part of the bulb.

6. Install the socket (together with the bulb) by turning it clockwise.
7. Install the headlight bulb socket cover.
8. Install the headlight unit by installing the screws.
9. Have a Yamaha dealer adjust the headlight beam if necessary.

## Replacing the tail/brake light bulb

EAU24131

1. Remove the tail/brake light lens by removing the screws.

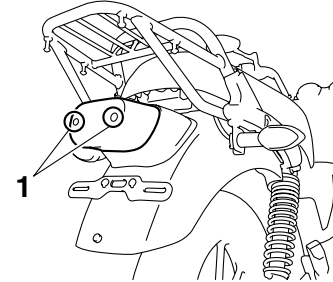

1. Screw

2. Remove the defective bulb by pushing it in and turning it counter-clockwise.

# PERIODIC MAINTENANCE AND MINOR REPAIR

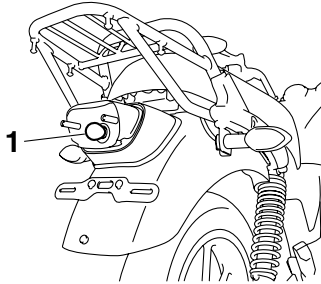

1. Tail/brake light bulb

3. Insert a new bulb into the socket, push it in, and then turn it clockwise until it stops.
4. Install the lens by installing the screws.

ECA10680

**CAUTION:** \_\_\_\_\_

**Do not overtighten the screws, otherwise the lens may break.**

## Replacing a turn signal light bulb

EAU24202

1. Remove the turn signal light lens by removing the screw.

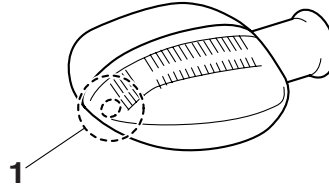

1. Screw

2. Remove the defective bulb by pushing it in and turning it counter-clockwise.
3. Insert a new bulb into the socket, push it in, and then turn it clockwise until it stops.
4. Install the lens by installing the screw.

ECA11190

**CAUTION:** \_\_\_\_\_

**Do not overtighten the screw, otherwise the lens may break.**

## Replacing the auxiliary light bulb

EAU37270

If the auxiliary light bulb burns out, replace it as follows.

1. Remove the headlight unit by removing the screws.

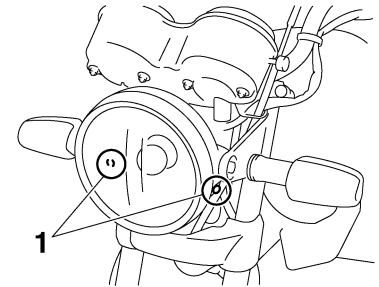

1. Screw

2. Remove the socket (together with the bulb) by pulling it out.

# PERIODIC MAINTENANCE AND MINOR REPAIR

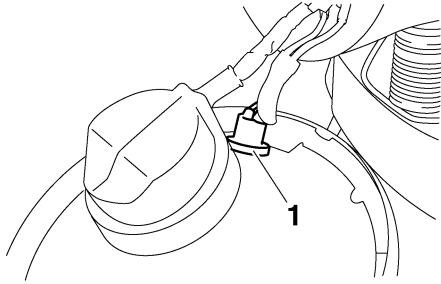

1. Auxiliary light bulb socket
3. Remove the defective bulb by pulling it out.

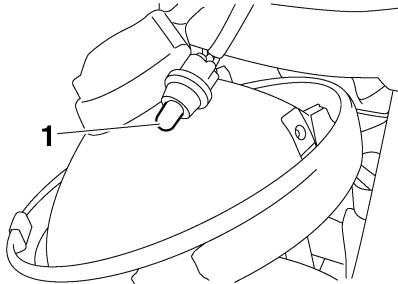

1. Auxiliary light bulb
4. Insert a new bulb into the socket.
5. Install the socket (together with the bulb) by pushing it in.
6. Install the headlight unit by installing the screws.

## Front wheel

EAU24360

EAU37041

EWA10820

### To remove the front wheel

#### **WARNING**

- It is advisable to have a Yamaha dealer service the wheel.
- Securely support the motorcycle so that there is no danger of it falling over.

1. Place the motorcycle on the centerstand.
2. Disconnect the speedometer cable from the front wheel.

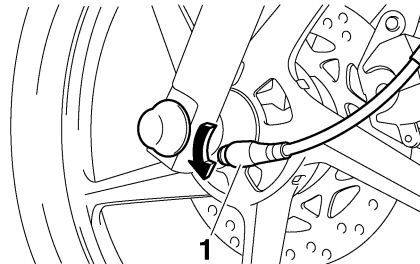

1. Speedometer cable

3. Remove the rubber caps from the ends of the wheel axle by pulling them off.

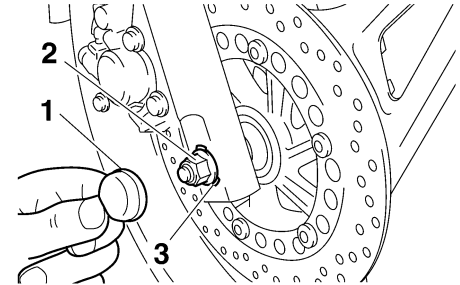

1. Rubber cap
2. Axle nut
3. Washer

4. Remove the axle nut and the washer.



# PERIODIC MAINTENANCE AND MINOR REPAIR

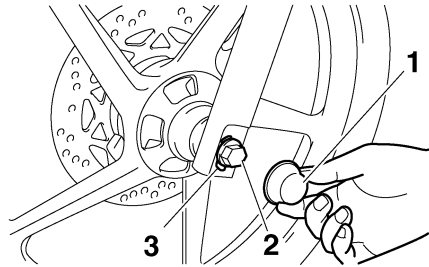

1. Rubber cap
2. Wheel axle
3. Washer

5. Pull the wheel axle out, and then remove the wheel.

ECA11070

## CAUTION:

**Do not apply the brake after the wheel has been removed together with the brake disc, otherwise the brake pads will be forced shut.**

EAU37030

## To install the front wheel

1. Install the speedometer gear unit into the wheel hub so that the projections mesh with the slots.

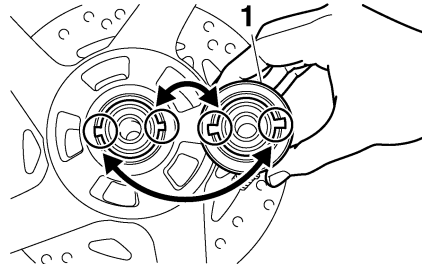

1. Speedometer gear unit
2. Lift the wheel up between the fork legs.

## NOTE:

Make sure that there is enough space between the brake pads before inserting the brake disc and that the slot in the speedometer gear unit fits over the retainer on the fork leg.

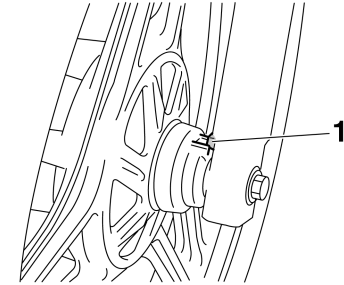

1. Speedometer gear unit retainer
3. Insert the wheel axle, making sure the washer on the left side is installed with the beveled side facing outward, and then install the axle nut.
4. Take the motorcycle off the centerstand so that the front wheel is on the ground.
5. Tighten the axle nut to the specified torque, and then install both rubber caps so that they fit over the washers.

## Tightening torque:

Axle nut:  
59 Nm (5.9 m-kgf, 43 ft-lbf)

# PERIODIC MAINTENANCE AND MINOR REPAIR

6. While applying the front brake, push down hard on the handlebars several times to check if the front fork compresses and rebounds smoothly.
7. Connect the speedometer cable.

## Rear wheel

EAU25080

### To remove the rear wheel

EAU37180

EWA10820

#### **WARNING**

- It is advisable to have a Yamaha dealer service the wheel.
- Securely support the motorcycle so that there is no danger of it falling over.

1. Loosen the axle nut and the brake torque rod nut at the brake shoe plate.
2. Disconnect the brake torque rod from the brake shoe plate by removing the cotter pin, the nut, and the bolt.

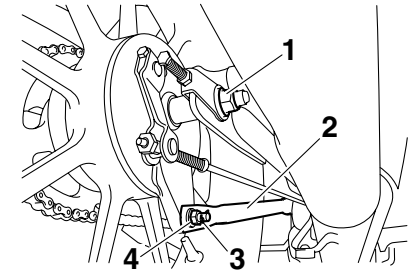

1. Axle nut
2. Brake torque rod
3. Brake torque rod cotter pin
4. Brake torque rod nut and bolt

3. Place the motorcycle on the centerstand.
4. Remove the brake pedal free play adjusting nut, and then disconnect the brake rod from the brake camshaft lever.

# PERIODIC MAINTENANCE AND MINOR REPAIR

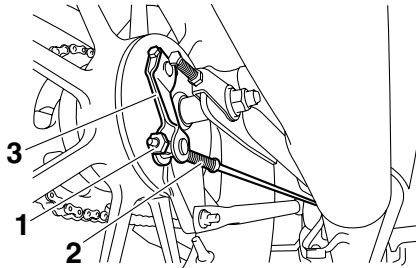

1. Brake pedal free play adjusting nut
2. Brake rod
3. Brake camshaft lever

5. Loosen the chain puller locknut and the drive chain slack adjusting bolt on both ends of the swingarm.

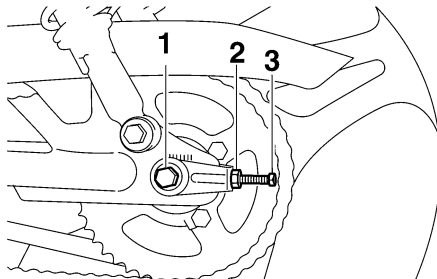

1. Wheel axle
2. Chain puller locknut
3. Drive chain slack adjusting bolt

6. Remove the axle nut, and then pull the wheel axle out.
7. Push the wheel forward, and then remove the drive chain from the rear sprocket.

## NOTE:

The drive chain does not need to be disassembled in order to remove and install the wheel.

8. Remove the wheel.

EAU37192

## To install the rear wheel

1. Install the wheel by inserting the wheel axle from the left-hand side.
2. Install the drive chain onto the rear sprocket.
3. Install the axle nut.
4. Install the brake rod onto the brake camshaft lever, and then install the brake pedal free play adjusting nut onto the brake rod.
5. Connect the brake torque rod to the brake shoe plate by installing the bolt and nut.
6. Adjust the drive chain slack. (See page 6-21.)

7. Take the motorcycle off the center-stand so that the rear wheel is on the ground.
8. Tighten the brake torque rod nut and axle nut to the specified torques.

## Tightening torques:

Brake torque rod nut:

19 Nm (1.9 m-kgf, 13 ft-lbf)

Axle nut:

80 Nm (8.0 m-kgf, 58 ft-lbf)

9. Insert a new cotter pin.
10. Adjust the brake pedal free play. (See page 6-17.)

EWA10660



**After adjusting the brake pedal free play, check the operation of the brake light.**

# PERIODIC MAINTENANCE AND MINOR REPAIR

---

EAU25850

## Troubleshooting

Although Yamaha motorcycles receive a thorough inspection before shipment from the factory, trouble may occur during operation. Any problem in the fuel, compression, or ignition systems, for example, can cause poor starting and loss of power.

The following troubleshooting chart represents a quick and easy procedure for checking these vital systems yourself. However, should your motorcycle require any repair, take it to a Yamaha dealer, whose skilled technicians have the necessary tools, experience, and know-how to service the motorcycle properly.

Use only genuine Yamaha replacement parts. Imitation parts may look like Yamaha parts, but they are often inferior, have a shorter service life and can lead to expensive repair bills.

# PERIODIC MAINTENANCE AND MINOR REPAIR

EAU45730

## Troubleshooting chart

EWA10840



**WARNING**

Keep away open flames and do not smoke while checking or working on the fuel system.

### 1. Fuel

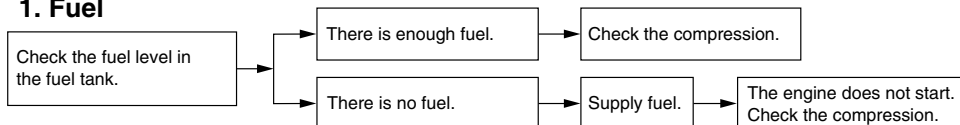

### 2. Compression

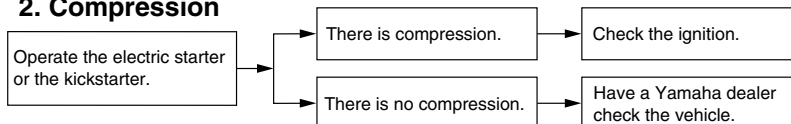

### 3. Ignition

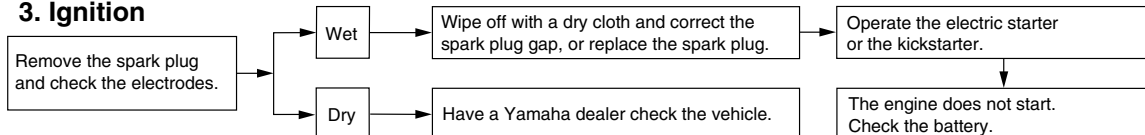

### 4. Battery

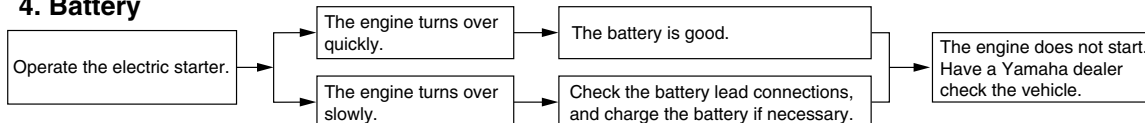

# MOTORCYCLE CARE AND STORAGE

---

## Matte color caution

EAU37833

ECA15192

### CAUTION:

Some models are equipped with matte colored finished parts. Be sure to consult a Yamaha dealer for advice on what products to use before cleaning the vehicle. Using a brush, harsh chemical products or cleaning compounds when cleaning these parts will scratch or damage their surface. Wax also should not be applied to any matte colored finished parts.

---

## Care

EAU26002

While the open design of a motorcycle reveals the attractiveness of the technology, it also makes it more vulnerable. Rust and corrosion can develop even if high-quality components are used. A rusty exhaust pipe may go unnoticed on a car, however, it detracts from the overall appearance of a motorcycle. Frequent and proper care does not only comply with the terms of the warranty, but it will also keep your motorcycle looking good, extend its life and optimize its performance.

## Before cleaning

1. Cover the muffler outlet with a plastic bag after the engine has cooled down.
2. Make sure that all caps and covers as well as all electrical couplers and connectors, including the spark plug cap, are tightly installed.
3. Remove extremely stubborn dirt, like oil burnt onto the crankcase, with a degreasing agent and a brush, but never apply such prod-

ucts onto seals, gaskets, sprockets, the drive chain and wheel axles. Always rinse the dirt and degreaser off with water.

## Cleaning

ECA10771

### CAUTION:

- Avoid using strong acidic wheel cleaners, especially on spoked wheels. If such products are used on hard-to-remove dirt, do not leave the cleaner on the affected area any longer than instructed. Also, thoroughly rinse the area off with water, immediately dry it, and then apply a corrosion protection spray.
- Improper cleaning can damage plastic parts such as cowlings, panels, windshields, headlight lenses, meter lenses, etc. Use only a soft, clean cloth or sponge with mild detergent and water to clean plastic.
- Do not use any harsh chemical products on plastic parts. Be sure to avoid using cloths or sponges which have been in

# MOTORCYCLE CARE AND STORAGE

contact with strong or abrasive cleaning products, solvent or thinner, fuel (gasoline), rust removers or inhibitors, brake fluid, antifreeze or electrolyte.

- Do not use high-pressure washers or steam-jet cleaners since they cause water seepage and deterioration in the following areas: seals (of wheel and swing-arm bearings, fork and brakes), electric components (couplers, connectors, instruments, switches and lights), breather hoses and vents.
- For motorcycles equipped with a windshield: Do not use strong cleaners or hard sponges as they will cause dulling or scratching. Some cleaning compounds for plastic may leave scratches on the windshield. Test the product on a small hidden part of the windshield to make sure that it does not leave any marks. If the windshield is

scratched, use a quality plastic polishing compound after washing.

## After normal use

Remove dirt with warm water, a mild detergent, and a soft, clean sponge, and then rinse thoroughly with clean water. Use a toothbrush or bottlebrush for hard-to-reach areas. Stubborn dirt and insects will come off more easily if the area is covered with a wet cloth for a few minutes before cleaning.

## After riding in the rain, near the sea or on salt-sprayed roads

Since sea salt or salt sprayed on roads during winter are extremely corrosive in combination with water, carry out the following steps after each ride in the rain, near the sea or on salt-sprayed roads.

## **NOTE:** \_\_\_\_\_

Salt sprayed on roads in the winter may remain well into spring.

1. Clean the motorcycle with cold water and a mild detergent, after the engine has cooled down.

ECA10790

## **CAUTION:** \_\_\_\_\_

**Do not use warm water since it increases the corrosive action of the salt.**

2. Apply a corrosion protection spray on all metal, including chrome- and nickel-plated, surfaces to prevent corrosion.

## **After cleaning**

1. Dry the motorcycle with a chamois or an absorbing cloth.
2. Immediately dry the drive chain and lubricate it to prevent it from rusting.
3. Use a chrome polish to shine chrome, aluminum and stainless-steel parts, including the exhaust system. (Even the thermally induced discoloring of stainless-steel exhaust systems can be removed through polishing.)

# MOTORCYCLE CARE AND STORAGE

---

ECA10800

4. To prevent corrosion, it is recommended to apply a corrosion protection spray on all metal, including chrome- and nickel-plated, surfaces.
5. Use spray oil as a universal cleaner to remove any remaining dirt.
6. Touch up minor paint damage caused by stones, etc.
7. Wax all painted surfaces.
8. Let the motorcycle dry completely before storing or covering it.

EWA11130

## WARNING

- **Make sure that there is no oil or wax on the brakes or tires.**
  - **If necessary, clean the brake discs and brake linings with a regular brake disc cleaner or acetone, and wash the tires with warm water and a mild detergent. Before riding at higher speeds, test the motorcycle's braking performance and cornering behavior.**
- 

## CAUTION:

- **Apply spray oil and wax sparingly and make sure to wipe off any excess.**
  - **Never apply oil or wax to any rubber and plastic parts, but treat them with a suitable care product.**
  - **Avoid using abrasive polishing compounds as they will wear away the paint.**
- 

## NOTE:

Consult a Yamaha dealer for advice on what products to use.

---

EUA43200

## Storage

### Short-term

Always store your motorcycle in a cool, dry place and, if necessary, protect it against dust with a porous cover.

ECA10810

## CAUTION:

- **Storing the motorcycle in a poorly ventilated room or covering it with a tarp, while it is still wet, will allow water and humidity to seep in and cause rust.**
  - **To prevent corrosion, avoid damp cellars, stables (because of the presence of ammonia) and areas where strong chemicals are stored.**
- 

### Long-term

Before storing your motorcycle for several months:

1. Follow all the instructions in the "Care" section of this chapter.
2. Fill up the fuel tank and add fuel stabilizer (if available) to prevent the fuel tank from rusting and the fuel from deteriorating.



# MOTORCYCLE CARE AND STORAGE

3. Perform the following steps to protect the cylinder, piston rings, etc. from corrosion.
  - a. Remove the spark plug cap and spark plug.
  - b. Pour a teaspoonful of engine oil into the spark plug bore.
  - c. Install the spark plug cap onto the spark plug, and then place the spark plug on the cylinder head so that the electrodes are grounded. (This will limit sparking during the next step.)
  - d. Turn the engine over several times with the starter. (This will coat the cylinder wall with oil.)
  - e. Remove the spark plug cap from the spark plug, and then install the spark plug and the spark plug cap.
4. Lubricate all control cables and the pivoting points of all levers and pedals as well as of the side-stand/centerstand.
5. Check and, if necessary, correct the tire air pressure, and then lift the motorcycle so that both of its wheels are off the ground. Alternatively, turn the wheels a little every month in order to prevent the tires from becoming degraded in one spot.
6. Cover the muffler outlet with a plastic bag to prevent moisture from entering it.
7. Remove the battery and fully charge it. Store it in a cool, dry place and charge it once a month. Do not store the battery in an excessively cold or warm place [less than 0 °C (30 °F) or more than 30 °C (90 °F)]. For more information on storing the battery, see page 6-27.

EWA10950

## **WARNING**

**To prevent damage or injury from sparking, make sure to ground the spark plug electrodes while turning the engine over.**

## **NOTE:** \_\_\_\_\_

Make any necessary repairs before storing the motorcycle.

# SPECIFICATIONS

## Dimensions:

Overall length:  
2055 mm (80.9 in)  
Overall width:  
845 mm (33.3 in)  
Overall height:  
1125 mm (44.3 in)  
Seat height:  
760 mm (29.9 in)  
Wheelbase:  
1290 mm (50.8 in)  
Ground clearance:  
140 mm (5.51 in)  
Minimum turning radius:  
1750 mm (68.9 in)

## Weight:

With oil and fuel:  
130.0 kg (287 lb)

## Engine:

Engine type:  
Air cooled 4-stroke, SOHC  
Cylinder arrangement:  
Forward-inclined single cylinder  
Displacement:  
123.7 cm<sup>3</sup>  
Bore × stroke:  
54.0 × 54.0 mm (2.13 × 2.13 in)  
Compression ratio:  
10.00 :1  
Starting system:  
Electric starter and kickstarter  
Lubrication system:  
Wet sump

## Engine oil:

Type:  
SAE 10W-30, SAE 10W-40, SAE 15W-40,  
SAE 20W-40 or SAE 20W-50

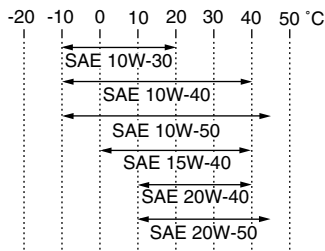

Recommended engine oil grade:  
API service SG type or higher, JASO  
standard MA  
Engine oil quantity:  
Periodic oil change:  
1.00 L (1.06 US qt, 0.88 Imp.qt)

## Air filter:

Air filter element:  
Dry element

## Fuel:

Recommended fuel:  
Regular unleaded gasoline only  
Fuel tank capacity:  
12.0 L (3.17 US gal, 2.64 Imp.gal)  
Fuel reserve amount:  
3.0 L (0.79 US gal, 0.66 Imp.gal)

## Fuel injection:

Throttle body:  
Manufacturer:  
MIKUNI  
Type/quantity:  
AC26-6/1

## Spark plug (s):

Manufacturer/model:  
NGK/CR6HSA  
Spark plug gap:  
0.6–0.7 mm (0.024–0.028 in)

## Clutch:

Clutch type:  
Wet, multiple-disc

## Transmission:

Primary reduction system:  
Helical gear  
Primary reduction ratio:  
68/20 (3.400)  
Secondary reduction system:  
Chain drive  
Secondary reduction ratio:  
43/14 (3.071)  
Transmission type:  
Constant mesh 5-speed  
Operation:  
Left foot operation  
Gear ratio:  
1st:  
37/14 (2.643)  
2nd:  
32/18 (1.778)  
3rd:  
25/19 (1.316)

4th:  
23/22 (1.045)

5th:  
21/24 (0.875)

## Chassis:

Frame type:  
Diamond

Caster angle:  
27.42 °

Trail:  
102.0 mm (4.02 in)

## Front tire:

Type:  
Tubeless

Size:  
3.00-18 47P

Manufacturer/model:  
CHENG SHIN/C-6039

## Rear tire:

Type:  
Tubeless

Size:  
3.50-16 58P

Manufacturer/model:  
CHENG SHIN/C-289

## Loading:

Maximum load:  
190 kg (419 lb)  
(Total weight of rider, passenger, cargo and accessories)

## Tire air pressure (measured on cold tires):

Loading condition:  
0–90 kg (0–198 lb)

Front:  
175 kPa (1.75 kgf/cm<sup>2</sup>, 25 psi)

Rear:  
200 kPa (2.00 kgf/cm<sup>2</sup>, 29 psi)

Loading condition:  
90–190 kg (198–419 lb)

Front:  
175 kPa (1.75 kgf/cm<sup>2</sup>, 25 psi)

Rear:  
280 kPa (2.80 kgf/cm<sup>2</sup>, 41 psi)

## Front wheel:

Wheel type:  
Cast wheel

Rim size:  
J18M/CxMT1.85

## Rear wheel:

Wheel type:  
Cast wheel

Rim size:  
J16M/CxMT2.15

## Front brake:

Type:  
Single disc brake

Operation:  
Right hand operation

Recommended fluid:  
DOT 3 or 4

## Rear brake:

Type:  
Drum brake

Operation:  
Right foot operation

## Front suspension:

Type:  
Telescopic fork  
Spring/shock absorber type:  
Coil spring/oil damper  
Wheel travel:  
110.0 mm (4.33 in)

## Rear suspension:

Type:  
Swingarm  
Spring/shock absorber type:  
Coil spring/oil damper  
Wheel travel:  
105.0 mm (4.13 in)

## Electrical system:

Ignition system:  
TCI (digital)  
Charging system:  
AC magneto

## Battery:

Model:  
YTX7L-BS  
Voltage, capacity:  
12 V, 6.0 Ah

## Headlight:

Bulb type:  
Incandescence

## Bulb voltage, wattage × quantity:

Headlight:  
12 V, 35 W/35.0 W × 1  
Tail/brake light:  
12 V, 5.0 W/21.0 W × 1  
Front turn signal light:  
12 V, 10.0 W × 2

# SPECIFICATIONS

---

Rear turn signal light:

12 V, 10.0 W  $\times$  2

Auxiliary light:

12 V, 5.0 W  $\times$  1

Meter lighting:

12 V, 1.7 W  $\times$  4

Neutral indicator light:

14 V, 3.0 W  $\times$  1

High beam indicator light:

14 V, 3.0 W  $\times$  1

Turn signal indicator light:

14 V, 3.0 W  $\times$  1

Engine trouble warning light:

14 V, 3.0 W  $\times$  1

## **Fuse:**

Fuse:

15.0 A

EAU26351

## Identification numbers

Record the key identification number, vehicle identification number and model label information in the spaces provided below for assistance when ordering spare parts from a Yamaha dealer or for reference in case the vehicle is stolen.

KEY IDENTIFICATION NUMBER:

VEHICLE IDENTIFICATION NUMBER:

MODEL LABEL INFORMATION:

## Key identification number

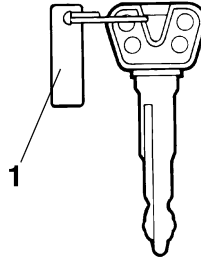

1. Key identification number

The key identification number is stamped into the key tag. Record this number in the space provided and use it for reference when ordering a new key.

EAU26381

## Vehicle identification number

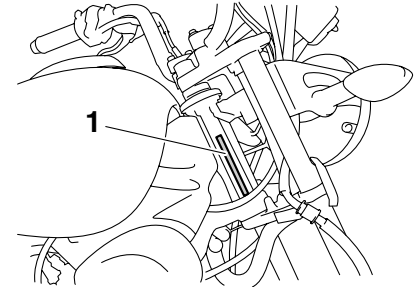

1. Vehicle identification number

The vehicle identification number is stamped into the steering head pipe. Record this number in the space provided.

**NOTE:** \_\_\_\_\_

The vehicle identification number is used to identify your motorcycle and may be used to register your motorcycle with the licensing authority in your area.

\_\_\_\_\_

# CONSUMER INFORMATION

---

EAU36980

## Model label

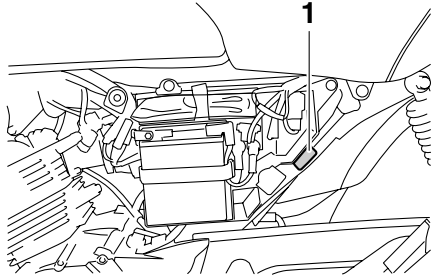

### 1. Model label

The model label is affixed to the frame behind panel A. (See page 6-6.) Record the information on this label in the space provided. This information will be needed when ordering spare parts from a Yamaha dealer.

- A**  
Air filter element, cleaning ..... 6-10  
Auxiliary light bulb, replacing ..... 6-31
- B**  
Battery ..... 6-27  
Brake and clutch levers,  
checking and lubricating ..... 6-23  
Brake fluid, changing ..... 6-20  
Brake fluid level, checking ..... 6-19  
Brake lever ..... 3-5  
Brake pads and shoes, checking ..... 6-19  
Brake pedal ..... 3-6  
Brake pedal, checking and  
lubricating ..... 6-24  
Brake pedal free play, adjusting ..... 6-17
- C**  
Cables, checking and lubricating ..... 6-23  
Care ..... 7-1  
Carrier ..... 3-9  
Catalytic converters ..... 3-8  
Centerstand and sidestand,  
checking and lubricating ..... 6-24  
Clutch lever ..... 3-5  
Clutch lever free play, adjusting ..... 6-16
- D**  
Dimmer switch ..... 3-4  
Drive chain, cleaning and lubricating .... 6-22  
Drive chain slack ..... 6-21
- E**  
Engine break-in ..... 5-3  
Engine idling speed, checking ..... 6-12  
Engine oil ..... 6-9  
Engine trouble warning light ..... 3-2
- F**  
Front brake lever free play, checking ....6-17  
Front fork, checking .....6-25  
Fuel .....3-7  
Fuel consumption, tips for reducing .....5-3  
Fuel gauge .....3-3  
Fuel tank cap .....3-6  
Fuse, replacing .....6-28
- H**  
Handlebar switches .....3-4  
Headlight bulb, replacing .....6-29  
High beam indicator light .....3-2  
Horn switch .....3-4
- I**  
Identification numbers .....9-1  
Ignition circuit cut-off system .....3-10  
Indicator and warning lights .....3-2
- K**  
Key identification number .....9-1  
Kickstarter .....3-8
- M**  
Main switch/steering lock .....3-1  
Matte color, caution .....7-1  
Model label .....9-2
- N**  
Neutral indicator light .....3-2
- P**  
Panels, removing and installing .....6-6  
Parking .....5-4  
Part locations .....2-1  
Periodic maintenance and  
lubrication chart .....6-2  
Pre-operation check list .....4-2
- R**  
Rear brake light switch, adjusting ..... 6-18
- S**  
Safety information ..... 1-1  
Self-diagnosis device ..... 3-3  
Shifting ..... 5-2  
Shift pedal ..... 3-5  
Shift pedal, checking ..... 6-18  
Shock absorber assemblies, adjusting ... 3-8  
Sidestand ..... 3-9  
Spark plug, checking ..... 6-7  
Specifications ..... 8-1  
Speedometer unit ..... 3-2  
Starting the engine ..... 5-1  
Start switch ..... 3-4  
Steering, checking ..... 6-26  
Storage ..... 7-3  
Swingarm pivots, lubricating ..... 6-25
- T**  
Tachometer ..... 3-3  
Tail/brake light bulb, replacing ..... 6-30  
Throttle cable free play, adjusting ..... 6-12  
Throttle grip and cable,  
checking and lubricating ..... 6-23  
Tires ..... 6-13  
Tool kit ..... 6-1  
Troubleshooting ..... 6-36  
Troubleshooting chart ..... 6-37  
Turn signal indicator light ..... 3-2  
Turn signal light bulb, replacing ..... 6-31  
Turn signal switch ..... 3-4
- V**  
Valve clearance ..... 6-13  
Vehicle identification number ..... 9-1

# INDEX

---

## W

Wheel bearings, checking.....	6-26
Wheel (front) .....	6-32
Wheel (rear) .....	6-34
Wheels .....	6-15







PRINTED IN CHINA  
2008.02-0.3x2 CR  
(E)