



 Read this manual carefully
before operating this vehicle.

OWNER'S MANUAL

JOGE

JOGE

CS50 / CS50M / CS50Z

2AD-F8199-E0

 **Read this manual carefully before operating this vehicle. This manual should stay with this vehicle if it is sold.**

Welcome to the Yamaha world of motorcycling!

As the owner of the CS50 / CS50M / CS50Z, you are benefiting from Yamaha's vast experience and newest technology regarding the design and manufacture of high-quality products, which have earned Yamaha a reputation for dependability.

Please take the time to read this manual thoroughly, so as to enjoy all advantages of your CS50 / CS50M / CS50Z. The Owner's Manual does not only instruct you in how to operate, inspect and maintain your scooter, but also in how to safeguard yourself and others from trouble and injury.

In addition, the many tips given in this manual will help keep your scooter in the best possible condition. If you have any further questions, do not hesitate to contact your Yamaha dealer.

The Yamaha team wishes you many safe and pleasant rides. So, remember to put safety first!

Yamaha continually seeks advancements in product design and quality. Therefore, while this manual contains the most current product information available at the time of printing, there may be minor discrepancies between your motorcycle and this manual. If there is any question concerning this manual, please consult a Yamaha dealer.





 **WARNING**

Please read this manual carefully and completely before operating this scooter.

IMPORTANT MANUAL INFORMATION

EAU10132

Particularly important information is distinguished in this manual by the following notations:

	<p>This is the safety alert symbol. It is used to alert you to potential personal injury hazards. Obey all safety messages that follow this symbol to avoid possible injury or death.</p>
	<p>A WARNING indicates a hazardous situation which, if not avoided, could result in death or serious injury.</p>
	<p>A NOTICE indicates special precautions that must be taken to avoid damage to the vehicle or other property.</p>
	<p>A TIP provides key information to make procedures easier or clearer.</p>

IMPORTANT MANUAL INFORMATION

EAUS1172

**CS50 / CS50M / CS50Z
OWNER'S MANUAL
©2012 by MBK INDUSTRIE
1st edition, March 2012
All rights reserved.
Any reprinting or unauthorized use
without the written permission of
MBK INDUSTRIE
is expressly prohibited.
Printed in France.**

TABLE OF CONTENTS

SAFETY INFORMATION1-1	Storage compartment.....3-11	Adjusting the throttle cable free play.....6-10
Further safe-riding points1-5	Adjusting the shock absorber assembly3-12	Tires6-11
DESCRIPTION2-1	Luggage hook.....3-13	Cast wheels6-12
Left view2-1		Checking the front brake lever free play.....6-13
Right view2-3		Adjusting the rear brake lever free play.....6-13
Controls and instruments2-5		Checking the front brake pads and rear brake shoes6-14
INSTRUMENT AND CONTROL FUNCTIONS3-1	FOR YOUR SAFETY- PRE-OPERATION CHECKS4-1	Checking the brake fluid level6-15
Main switch/steering lock.....3-1	Pre-operation check list.....4-2	Changing the brake fluid6-16
Indicator and warning lights3-2	OPERATION AND IMPORTANT RIDING POINTS5-1	Checking and lubricating the throttle grip and cable.....6-16
Turn signal indicator lights3-2	Starting a cold engine5-1	Lubricating the front and rear brake levers6-16
High beam indicator light3-2	Starting off5-2	Checking and lubricating the centerstand6-17
Oil level warning light3-3	Acceleration and deceleration5-2	Checking the front fork.....6-18
Speedometer3-3	Braking.....5-3	Checking the steering.....6-18
Multi-function display3-4	Tips for reducing fuel consumption..5-3	Checking the wheel bearings6-19
Handlebar switches3-6	Engine break-in.....5-4	Battery6-19
Dimmer switch.....3-6	Parking.....5-4	Replacing the fuse.....6-20
Turn signal switch3-6	PERIODIC MAINTENANCE AND ADJUSTMENT6-1	Replacing the headlight bulb or a front turn signal light bulb....6-21
Horn switch.....3-6	Periodic maintenance and lubrication chart6-2	Replacing the tail/brake light bulb or a rear turn signal light bulb....6-23
Start switch.....3-6	Removing and installing the cowling and panel6-5	Replacing the license plate light bulb6-24
Front brake lever.....3-6	Checking the spark plug6-6	Replacing an auxiliary light bulb....6-24
Rear brake lever.....3-7	Final transmission oil6-7	Troubleshooting6-25
Fuel and 2-stroke engine oil tank caps.....3-7	Coolant6-8	
Fuel3-8	Air filter element.....6-9	
Catalytic converter.....3-9	Adjusting the carburetor6-10	
2-stroke engine oil3-10		
Kickstarter.....3-10		
Rider seat.....3-11		

TABLE OF CONTENTS

Troubleshooting charts	6-26
SCOOTER CARE AND STORAGE	7-1
Matte color caution.....	7-1
Care	7-1
Storage	7-3
SPECIFICATIONS	8-1
CONSUMER INFORMATION	9-1
Identification numbers	9-1
Key identification number.....	9-1
Vehicle identification number.....	9-1
Model label	9-2

SAFETY INFORMATION

EAUT1012

Be a Responsible Owner

As the vehicle's owner, you are responsible for the safe and proper operation of your scooter.

Scooters are single-track vehicles.

Their safe use and operation are dependent upon the use of proper riding techniques as well as the expertise of the operator. Every operator should know the following requirements before riding this scooter.

He or she should:

- Obtain thorough instructions from a competent source on all aspects of scooter operation.
- Observe the warnings and maintenance requirements in this Owner's Manual.
- Obtain qualified training in safe and proper riding techniques.
- Obtain professional technical service as indicated in this Owner's Manual and/or when made necessary by mechanical conditions.

Safe Riding

Perform the pre-operation checks each time you use the vehicle to

make sure it is in safe operating condition. Failure to inspect or maintain the vehicle properly increases the possibility of an accident or equipment damage. See page 4-1 for a list of pre-operation checks.

- This scooter is designed to carry the operator and a passenger.

TIP

Although this scooter is designed to carry a passenger, always comply with the local regulations.

- The failure of motorists to detect and recognize scooters in traffic is the predominating cause of automobile/scooter accidents. Many accidents have been caused by an automobile driver who did not see the scooter. Making yourself conspicuous appears to be very effective in reducing the chance of this type of accident.

Therefore:

- Wear a brightly colored jacket.
- Use extra caution when you are approaching and passing through intersections, since

intersections are the most likely places for scooter accidents to occur.

- Ride where other motorists can see you. Avoid riding in another motorist's blind spot.
- Many accidents involve inexperienced operators. In fact, many operators who have been involved in accidents do not even have a current driver's license.
- Make sure that you are qualified and that you only lend your scooter to other qualified operators.
- Know your skills and limits. Staying within your limits may help you to avoid an accident.
- We recommend that you practice riding your scooter where there is no traffic until you have become thoroughly familiar with the scooter and all of its controls.
- Many accidents have been caused by error of the scooter operator. A typical error made by the operator is veering wide on a turn due to excessive speed or under-

cornering (insufficient lean angle for the speed).

- Always obey the speed limit and never travel faster than warranted by road and traffic conditions.
- Always signal before turning or changing lanes. Make sure that other motorists can see you.
- The posture of the operator and passenger is important for proper control.
- The operator should keep both hands on the handlebar and both feet on the operator footrests during operation to maintain control of the scooter.
- The passenger should always hold onto the operator, the seat strap or grab bar, if equipped, with both hands and keep both feet on the passenger footrests. Never carry a passenger unless he or she can firmly place both feet on the passenger footrests.
- Never ride under the influence of alcohol or other drugs.
- This scooter is designed for on-

road use only. It is not suitable for off-road use.

Protective apparel

The majority of fatalities from scooter accidents are the result of head injuries. The use of a safety helmet is the single most critical factor in the prevention or reduction of head injuries.

- Always wear an approved helmet.
- Wear a face shield or goggles. Wind in your unprotected eyes could contribute to an impairment of vision that could delay seeing a hazard.
- The use of a jacket, substantial shoes, trousers, gloves, etc., is effective in preventing or reducing abrasions or lacerations.
- Never wear loose-fitting clothes, otherwise they could catch on the control levers or wheels and cause injury or an accident.
- Always wear protective clothing that covers your legs, ankles, and feet. The engine or exhaust system become very hot during or after operation and can cause burns.

- A passenger should also observe the above precautions.

Avoid Carbon Monoxide Poisoning

All engine exhaust contains carbon monoxide, a deadly gas. Breathing carbon monoxide can cause headaches, dizziness, drowsiness, nausea, confusion, and eventually death.

Carbon Monoxide is a colorless, odorless, tasteless gas which may be present even if you do not see or smell any engine exhaust. Deadly levels of carbon monoxide can collect rapidly and you can quickly be overcome and unable to save yourself. Also, deadly levels of carbon monoxide can linger for hours or days in enclosed or poorly ventilated areas. If you experience any symptoms of carbon monoxide poisoning, leave the area immediately, get fresh air, and **SEEK MEDICAL TREATMENT.**

SAFETY INFORMATION

1

- Do not run engine indoors. Even if you try to ventilate engine exhaust with fans or open windows and doors, carbon monoxide can rapidly reach dangerous levels.
- Do not run engine in poorly ventilated or partially enclosed areas such as barns, garages, or carports.
- Do not run engine outdoors where engine exhaust can be drawn into a building through openings such as windows and doors.

Loading

Adding accessories or cargo to your scooter can adversely affect stability and handling if the weight distribution of the scooter is changed. To avoid the possibility of an accident, use extreme caution when adding cargo or accessories to your scooter. Use extra care when riding a scooter that has added cargo or accessories. Here, along with the information about accessories below, are some general guidelines to follow if loading cargo to your scooter:

The total weight of the operator, passenger, accessories and cargo must not exceed the maximum load limit.

Operation of an overloaded vehicle could cause an accident.

<p>Maximum load: CS50 169 kg (373 lb) CS50M 169 kg (373 lb) CS50Z 166 kg (366 lb)</p>
--

When loading within this weight limit, keep the following in mind:

- Cargo and accessory weight should be kept as low and close to the scooter as possible. Securely pack your heaviest items as close to the center of the vehicle as possible and make sure to distribute the weight as evenly as possible on both sides of the scooter to minimize imbalance or instability.
- Shifting weights can create a sudden imbalance. Make sure that accessories and cargo are securely attached to the scooter before riding. Check accessory mounts and cargo restraints frequently.

- Properly adjust the suspension for your load (suspension-adjustable models only), and check the condition and pressure of your tires.
- Never attach any large or heavy items to the handlebar, front fork, or front fender. Such items can create unstable handling or a slow steering response.
- **This vehicle is not designed to pull a trailer or to be attached to a sidecar.**

Genuine Yamaha Accessories

Choosing accessories for your vehicle is an important decision. Genuine Yamaha accessories, which are available only from a Yamaha dealer, have been designed, tested, and approved by Yamaha for use on your vehicle. Many companies with no connection to Yamaha manufacture parts and accessories or offer other modifications for Yamaha vehicles. Yamaha is not in a position to test the products that these aftermarket companies produce. Therefore, Yamaha can neither endorse nor recommend the use of accessories not sold by Yamaha or

modifications not specifically recommended by Yamaha, even if sold and installed by a Yamaha dealer.

Aftermarket Parts, Accessories, and Modifications

While you may find aftermarket products similar in design and quality to genuine Yamaha accessories, recognize that some aftermarket accessories or modifications are not suitable because of potential safety hazards to you or others. Installing aftermarket products or having other modifications performed to your vehicle that change any of the vehicle's design or operation characteristics can put you and others at greater risk of serious injury or death. You are responsible for injuries related to changes in the vehicle.

Keep the following guidelines in mind, as well as those provided under "Loading" when mounting accessories.

- Never install accessories or carry cargo that would impair the performance of your scooter. Carefully inspect the accessory before using it to make sure that it does not in any way reduce

ground clearance or cornering clearance, limit suspension travel, steering travel or control operation, or obscure lights or reflectors.

- Accessories fitted to the handlebar or the front fork area can create instability due to improper weight distribution or aerodynamic changes. If accessories are added to the handlebar or front fork area, they must be as lightweight as possible and should be kept to a minimum.
- Bulky or large accessories may seriously affect the stability of the scooter due to aerodynamic effects. Wind may attempt to lift the scooter, or the scooter may become unstable in cross winds. These accessories may also cause instability when passing or being passed by large vehicles.
- Certain accessories can displace the operator from his or her normal riding position. This improper position limits the fre-

edom of movement of the operator and may limit control ability, therefore, such accessories are not recommended.

- Use caution when adding electrical accessories. If electrical accessories exceed the capacity of the scooter's electrical system, an electric failure could result, which could cause a dangerous loss of lights or engine power.

Aftermarket Tires and Rims

The tires and rims that came with your scooter were designed to match the performance capabilities and to provide the best combination of handling, braking, and comfort. Other tires, rims, sizes, and combinations may not be appropriate. Refer to page 6-11 for tire specifications and more information on replacing your tires.

SAFETY INFORMATION

EAU10372

Further safe-riding points

1

- Be sure to signal clearly when making turns.
 - Braking can be extremely difficult on a wet road. Avoid hard braking, because the scooter could slide. Apply the brakes slowly when stopping on a wet surface.
 - Slow down as you approach a corner or turn. Once you have completed a turn, accelerate slowly.
 - Be careful when passing parked cars. A driver might not see you and open a door in your path.
 - Railroad crossings, streetcar rails, iron plates on road construction sites, and manhole covers become extremely slippery when wet. Slow down and cross them with caution. Keep the scooter upright, otherwise it could slide out from under you.
 - The brake pads could get wet when you wash the scooter. After washing the scooter, check the brakes before riding.
- Always wear a helmet, gloves, trousers (tapered around the cuff and ankle so they do not flap), and a bright colored jacket.
 - Do not carry too much luggage on the scooter. An overloaded scooter is unstable. Use a strong cord to secure any luggage to the carrier (if equipped). A loose load will affect the stability of the scooter and could divert your attention from the road. (See page 1-1).

Left view CS50/CS50M

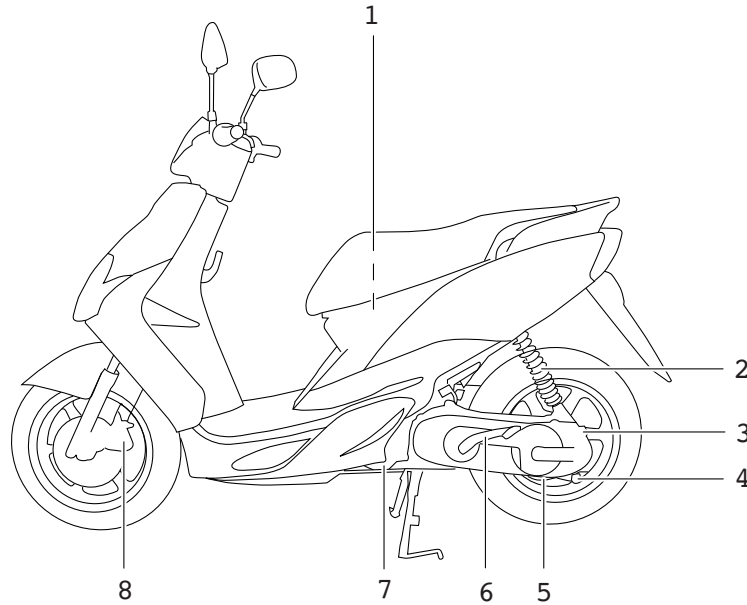

- 1. Storage compartment (page 3-11)
- 2. Shock absorber assembly (page 3-12)
- 3. Final transmission oil filler cap (page 6-7)
- 4. Adjusting nut (page 6-13)

- 5. Final transmission oil drain bolt (page 6-7)
- 6. Kickstarter (page 3-10)
- 7. Air filter element (page 6-9)
- 8. Front brake pads (page 6-14)

DESCRIPTION

CS50Z

2

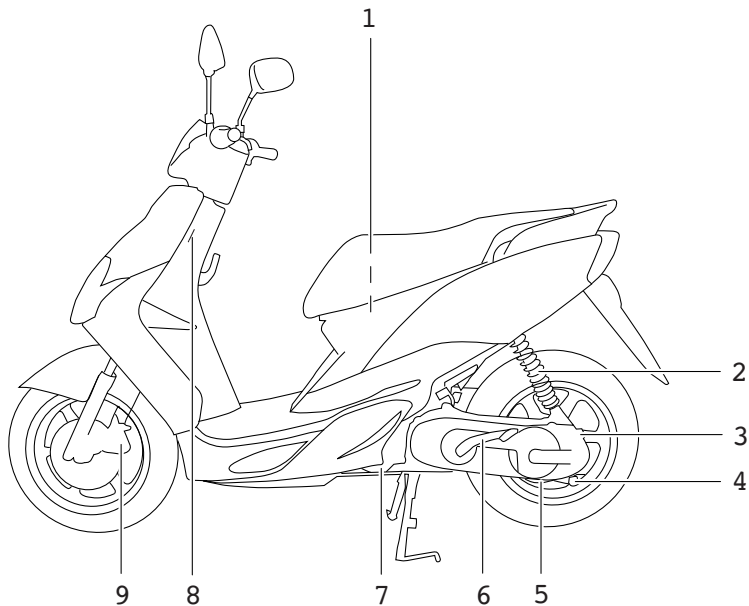

1. Storage compartment (page 3-11)

2. Shock absorber assembly (page 3-12)

3. Final transmission oil filler cap (page 6-7)

4. Adjusting nut (page 6-13)

5. Final transmission oil drain bolt (page 6-7)

6. Kickstarter (page 3-10)

7. Air filter element (page 6-9)

8. Coolant level check window (page 6-8)

9. Front brake pads (page 6-14)

Right view CS50/CS50M

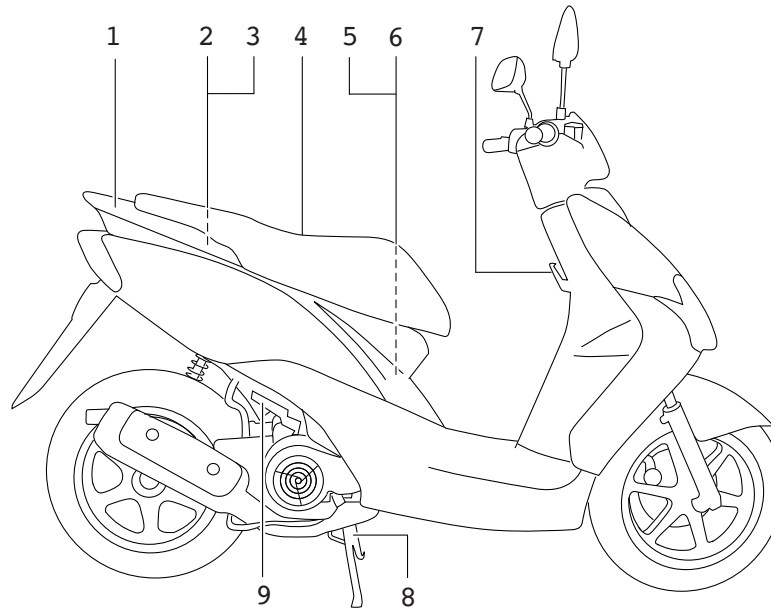

- 1. Grab bar (page 5-2)
- 2. Oil tank cap (page 3-7/3-10)
- 3. Fuel tank cap (page 3-7)
- 4. Seat (page 3-11)
- 5. Battery (page 6-19)

- 6. Fuse (page 6-20)
- 7. Luggage hook (page 3-13)
- 8. Centerstand (page 6-17)
- 9. Passenger footrest

DESCRIPTION

CS50Z

2

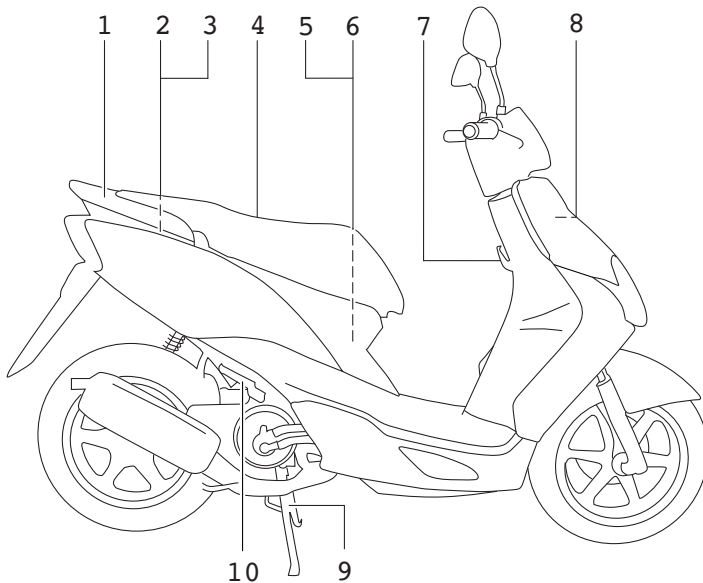

1. Grab bar (page 5-2)
2. Oil tank cap (page 3-7/3-10)
3. Fuel tank cap (page 3-7)
4. Seat (page 3-11)
5. Battery (page 6-19)

6. Fuse (page 6-20)
7. Luggage hook (page 3-13)
8. Coolant reservoir cap (page 6-8)
9. Centerstand (page 6-17)
10. Passenger footrest

Controls and instruments CS50/CS50M/CS50Z

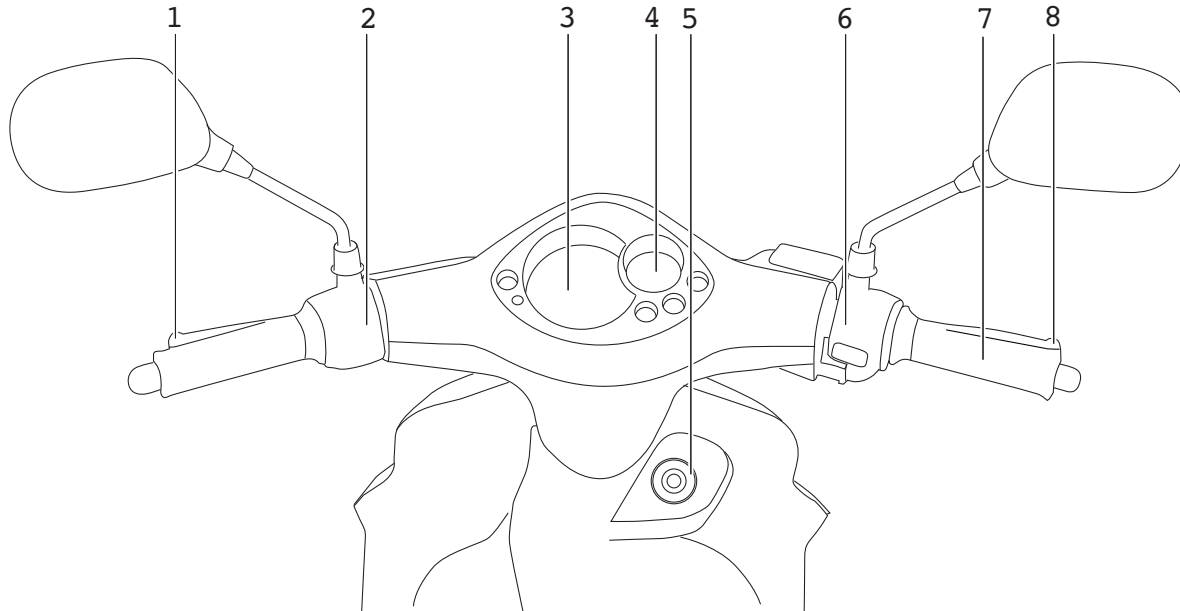

1. Rear brake lever (page 3-7)
2. Left handlebar switches (page 3-6)
3. Speedometer (page 3-3)
4. Multi-function display (page 3-4)

5. Main switch/steering lock (page 3-1)
6. Right handlebar switch (page 3-6)
7. Throttle grip (page 6-10)
8. Front brake lever (page 3-6)

INSTRUMENT AND CONTROL FUNCTIONS

Main switch/steering lock

EAU10460

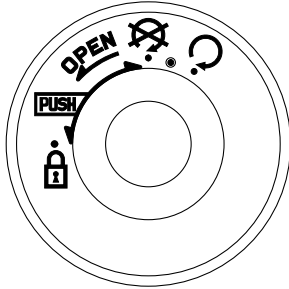

3

The main switch/steering lock controls the ignition and lighting systems, and is used to lock the steering. The various positions are described below.

“○” ON

EAU10640

All electrical circuits are supplied with power, and the engine can be started. The key cannot be removed.

TIP

The headlight, meter lighting and tail light come on automatically when the engine is started.

“⊗” OFF

EAU10661

All electrical systems are off. The key can be removed.

⚠ WARNING

EWA10061

Never turn the key to “⊗” or “⊔” while the vehicle is moving. Otherwise the electrical systems will be switched off, which may result in loss of control or an accident.



EAU10670

The 2-stroke engine oil level warning light should come on. (See page 3-2).

“⊔” LOCK

EAU10681

The steering is locked, and all electrical systems are off. The key can be removed.

To lock the steering

1

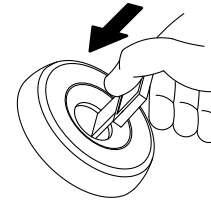

2

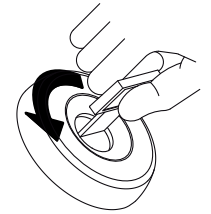

1. Push.
2. Turn.

1. Turn the handlebars all the way to the left.
2. Push the key in from the “⊗” position, and then turn it to “⊔” while still pushing it.
3. Remove the key.

INSTRUMENT AND CONTROL FUNCTIONS

To unlock the steering

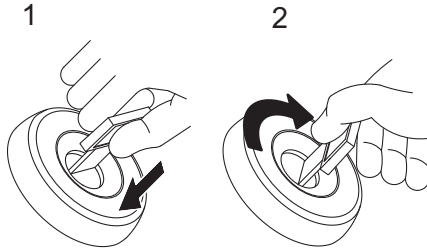

1. Push.
2. Turn.





1. Push the key in, and then turn it to “” while still pushing it.

EAU11003

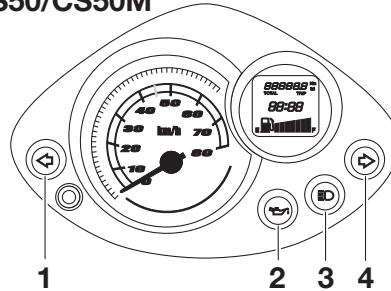
Indicator and warning lights





CS50/CS50M

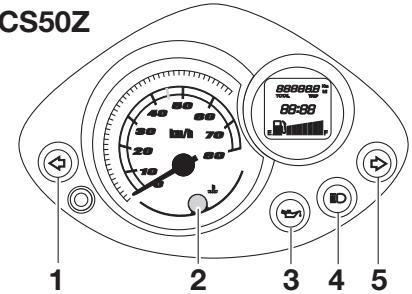

1. Left turn signal indicator light “”
2. Oil level warning light “”
3. High beam indicator light “”
4. Right turn signal indicator light “”

CS50Z



1. Left turn signal indicator light “”
2. Coolant temperature warning light “”
3. Oil level warning light “”
4. High beam indicator light “”
5. Right turn signal indicator light “”

EAU11030

Turn signal indicator lights “” and “”

The corresponding indicator light flashes when the turn signal switch is pushed to the left or right.

EAU11080

High beam indicator light “”

This indicator light comes on when the high beam of the headlight is switched on.

INSTRUMENT AND CONTROL FUNCTIONS

3

EAU11181

Oil level warning light “”

This warning light comes on when the key is in the “” position or if the oil level in the 2-stroke engine oil tank is low during operation. If the warning light comes on during operation, stop immediately and fill the oil tank with Yamalube 2 or equivalent 2-stroke engine oil of either JASO grade “FC” or ISO grades “EG-C” or “EG-D”. The warning light should go off after the 2-stroke engine oil tank has been refilled.

TIP

If the warning light does not come on when the key is in the “” position or does not go off after the 2-stroke engine oil tank has been refilled, have a Yamaha dealer check the electrical circuit.

ECA16291

NOTICE

Do not operate the vehicle until you know that the engine oil level is sufficient.

EAUS1530

Speedometer CS50/CS50M

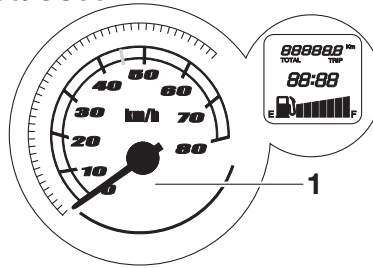

1. Speedometer

CS50Z

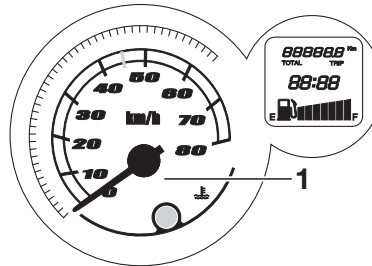

1. Speedometer

CS50/CS50M (for UK only)

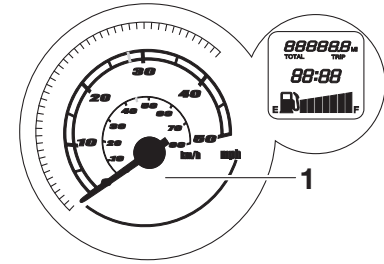

1. Speedometer

CS50Z (for UK only)

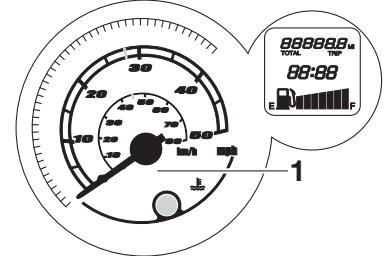

1. Speedometer

The speedometer shows the riding speed.

INSTRUMENT AND CONTROL FUNCTIONS

Multi-function display

EAUS1424

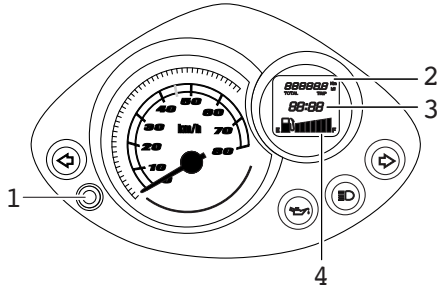

1. Select button
2. Odometer/tripmeter
3. Clock
4. Fuel meter

⚠ WARNING

EWA12312

Be sure to stop the vehicle before making any setting changes to the multi-function display. Changing settings while riding can distract the operator and increase the risk of an accident.

The multi-function display is equipped with the following:

- a digital clock
- an odometer (which shows the total distance traveled)

- a tripmeter (which shows the distance traveled since it was last set to zero)
- a fuel gauge
- a self-diagnosis device
- a function button (which selects, sets and resets various modes of the multi-function display)

TIP

- Be sure to turn the key to “ \odot ” before using the button.
- For the U.K. only: The odometer and tripmeter are displayed in miles.

To set the clock:

1. Select the odometer and push the button for at least two seconds.
2. When the hour digits start flashing, push the button to set the hours.

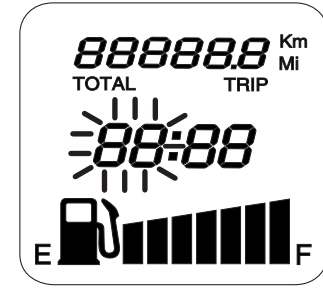

3. To change the ten-minute digit, push the button for at least two seconds.
4. When the ten-minute digit starts flashing, push the button to set it.

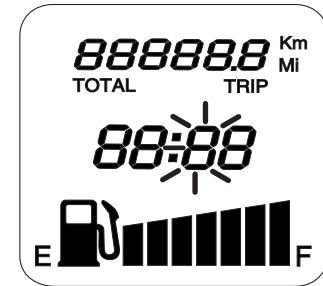

5. To change the one-minute digit, push the button for at least two seconds.

INSTRUMENT AND CONTROL FUNCTIONS

6. When the one-minute digit starts flashing, push the button to set it.

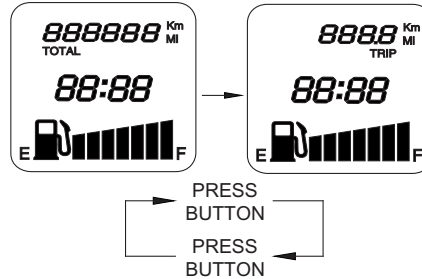
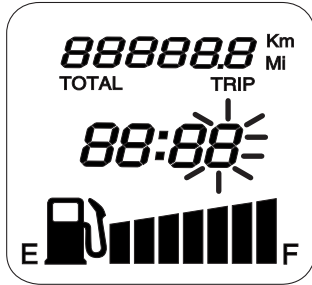

1. Odometer
2. Tripmeter

7. Push the button for at least two seconds to start the clock.

TIP

After setting the clock, be sure to push the button for at least two seconds before turning the key to “ \otimes ”, otherwise the clock will not be set.

Odometer and tripmeter modes

Pushing the button switches the display between the odometer mode “ODO” and the tripmeter “TRIP” in the following order:

ODO → TRIP → ODO

the fuel gauge will flash. If this occurs, have a Yamaha dealer check the vehicle.

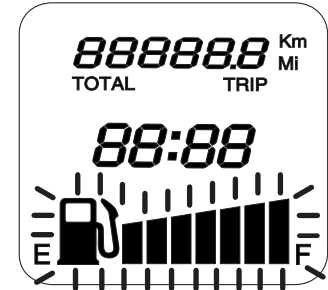

To reset the tripmeter, select it by pushing the button, and then push it again for at least two seconds.

Fuel gauge

The fuel gauge indicates the amount of fuel in the fuel tank. The display segments of the fuel gauge disappear towards “E” (Empty) as the fuel level decreases. When only one segment is left near “E”, refuel as soon as possible.

Self-diagnosis device

This model is equipped with a self-diagnosis device for the fuel electrical circuit.

If a problem is detected in the fuel electrical circuit, all LCD segments of

INSTRUMENT AND CONTROL FUNCTIONS

EAU12347

Handlebar switches

Left

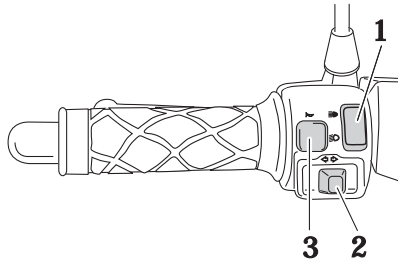

1. Dimmer switch “ / ”
2. Turn signal switch “ / ”
3. Horn switch “”

Right

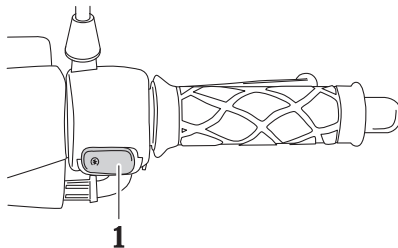

1. Start switch “”

EAU12400

Dimmer switch “ / ”

Set this switch to “” for the high beam and to “” for the low beam.

EAU12460

Turn signal switch “ / ”

To signal a right-hand turn, push this switch to “”. To signal a left-hand turn, push this switch to “”. When released, the switch returns to the center position. To cancel the turn signal lights, push the switch in after it has returned to the center position.

EAU12500

Horn switch “”

Press this switch to sound the horn.

EAUM1132

Start switch “”

Push this switch while applying the front or rear brake to crank the engine with the starter. See page 5-1 for starting instructions prior to starting the engine.

EAU12900

Front brake lever

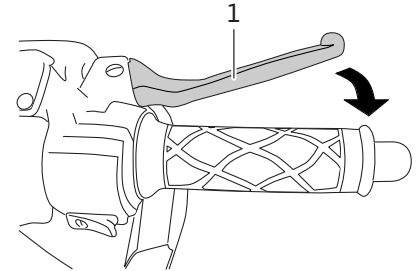

1. Front brake lever

The front brake lever is located on the right handlebar grip. To apply the front brake, pull this lever toward the handlebar grip.

INSTRUMENT AND CONTROL FUNCTIONS

EAU12950

Rear brake lever

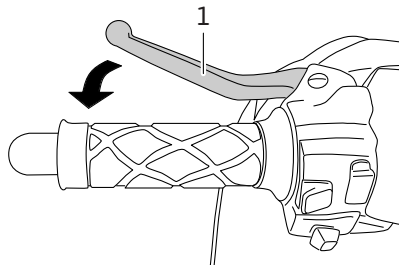

1. Rear brake lever

The rear brake lever is located on the left handlebar grip. To apply the rear brake, pull this lever toward the handlebar grip.

EAU13202

Fuel and 2-stroke engine oil tank caps

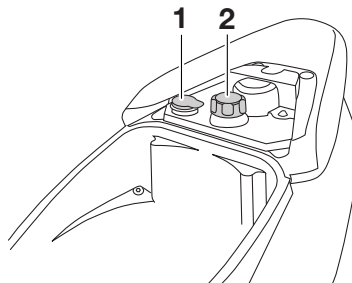

1. 2-stroke engine oil tank cap
2. Fuel tank cap

The fuel tank cap and the 2-stroke engine oil tank cap are located under the seat. (See page 3-11).

Fuel tank cap

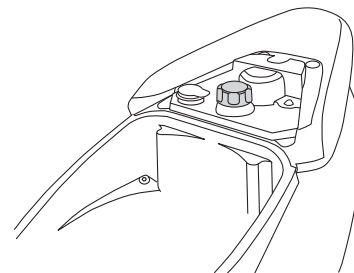

To remove the fuel tank cap, turn it counterclockwise, and then pull it off. To install the fuel tank cap, turn it clockwise.

2-stroke engine oil tank cap

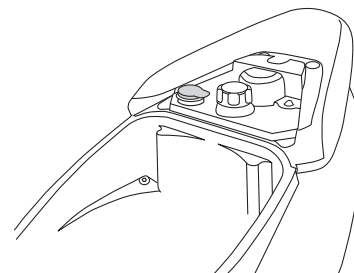

To remove the 2-stroke engine oil tank cap, pull it off.

INSTRUMENT AND CONTROL FUNCTIONS

To install the 2-stroke engine oil tank cap, push it into the oil tank opening.

EAU13212

⚠ WARNING

EWA10141

Make sure that the fuel and 2-stroke engine oil tank caps are properly installed before riding the scooter. Leaking fuel is a fire hazard.

Fuel

Make sure there is sufficient gasoline in the tank.

EWA10881

⚠ WARNING

Gasoline and gasoline vapors are extremely flammable. To avoid fires and explosions and to reduce the risk of injury when refueling, follow these instructions.

1. Before refueling, turn off the engine and be sure that no one is sitting on the vehicle. Never refuel while smoking, or while in the vicinity of sparks, open flames, or other sources of ignition such as the pilot lights of water heaters and clothes dryers.
2. Do not overfill the fuel tank. Stop filling when the fuel reaches the bottom of the filler tube. Because fuel expands when it heats up, heat from the engine or the sun can cause fuel to spill out of the fuel tank.

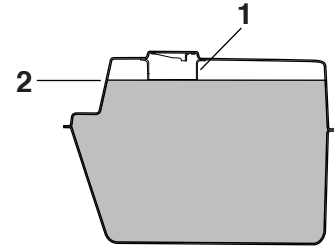

ZAJM020

1. Fuel tank filler tube

2. Fuel level

3. Wipe up any spilled fuel immediately. **NOTICE: Immediately wipe off spilled fuel with a clean, dry, soft cloth, since fuel may deteriorate painted surfaces or plastic parts.** [ECA10071]
4. Be sure to securely close the fuel tank cap.

EWA15151

⚠ WARNING

Gasoline is poisonous and can cause injury or death. Handle gasoline with care. Never siphon gasoline by mouth. If you should swallow some gasoline or inhale a lot of gasoline vapor, or get some gasoline in your

INSTRUMENT AND CONTROL FUNCTIONS

eyes, see your doctor immediately. If gasoline spills on your skin, wash with soap and water. If gasoline spills on your clothing, change your clothes.

EAU13270

Recommended fuel:
REGULAR UNLEADED
GASOLINE ONLY

Fuel tank capacity:
5.5 L (1.45 US gal, 1.21 Imp.gal)

Fuel reserve amount:
1.9 L (0.50 US gal, 0.42 Imp.gal)

Your Yamaha engine has been designed to use regular unleaded gasoline with a research octane number of 91 or higher. If knocking (or pinging) occurs, use a gasoline of a different brand or premium unleaded fuel. Use of unleaded fuel will extend spark plug life and reduce maintenance costs.

Catalytic converter

EAU13432

This model is equipped with a catalytic converter in the exhaust system.

EWA10861

WARNING

The exhaust system is hot after operation. To prevent a fire hazard or burns:

- Do not park the vehicle near possible fire hazards such as grass or other materials that easily burn.
- Park the motorcycle in a place where pedestrians or children are not likely to touch the hot exhaust system.
- Make sure that the exhaust system has cooled down before doing any maintenance work.
- Do not allow the engine to idle more than a few minutes. Long idling can cause a build-up of heat.

ECA10701

NOTICE

Use only unleaded gasoline. The use of leaded gasoline will cause unreparable damage to the catalytic converter.

INSTRUMENT AND CONTROL FUNCTIONS

EAUS1500

2-stroke engine oil

Make sure that there is sufficient 2-stroke engine oil in the oil tank. Add the recommended 2-stroke engine oil as necessary.

To access the 2-stroke engine oil tank, open the storage compartment. See page 3-11).

1. Remove the 2-stroke engine oil tank cap by pulling it off.

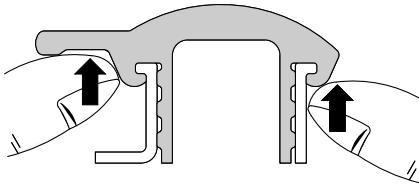

2. Install the 2-stroke engine oil tank cap by pushing it into the oil tank opening.

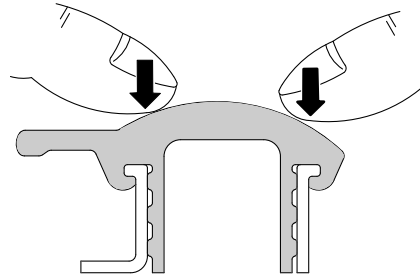

TIP

Make sure that the 2-stroke engine oil tank cap is properly installed before riding the vehicle.

Recommended oil:

See page 8-1

Oil quantity:

1.4 L (1.48 US qt) (1.23 Imp.qt)

EAUS1050

Kickstarter

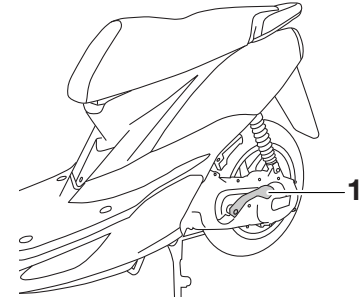

1. Kickstarter lever

To start the engine, push the kickstarter down lightly with your foot until the gears engage, and then push it down smoothly but forcefully.

INSTRUMENT AND CONTROL FUNCTIONS

EAU14160

Rider seat

To open the rider seat

1. Place the scooter on the centerstand.
2. Insert the key into the main switch, and then turn it counter-clockwise.

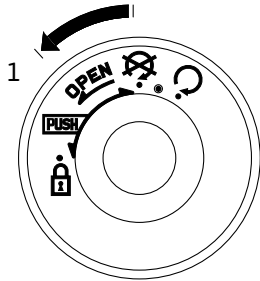

1. Open.

TIP

Do not push inward when turning the key.

3. Fold the rider seat up.

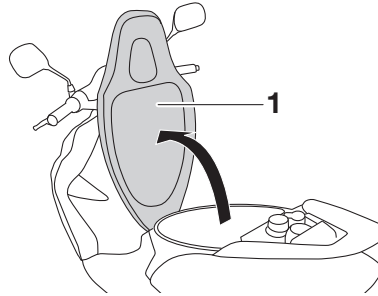

1. Seat

To close the rider seat

1. Fold the rider seat down, and then push it down to lock it in place.
2. Remove the key from the main switch if the scooter will be left unattended.

TIP

Make sure that the seat is properly secured before riding.

EAU14510

Storage compartment

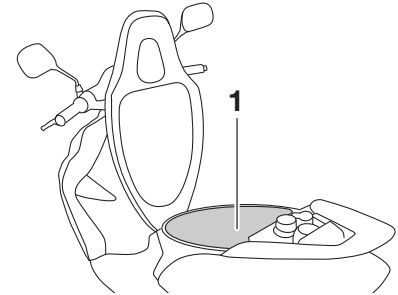

1. Storage compartment

There is a storage compartment under the seat. (See page 3-11).

EWA10960

WARNING

- Do not exceed the load limit of 3.5 kg (7.7 lb) for the storage compartment.
- Do not exceed the maximum load of CS50/CS50M 169 kg (373 lb) CS50Z 166 kg (366 lb) for the vehicle.

INSTRUMENT AND CONTROL FUNCTIONS

ECA10080

NOTICE

Keep the following points in mind when using the storage compartment.

- Since the storage compartment accumulates heat when exposed to the sun, do not store anything susceptible to heat inside it.
- To avoid humidity from spreading through the storage compartment, wrap wet articles in a plastic bag before storing them in the compartment.
- Since the storage compartment may get wet while the scooter is being washed, wrap any articles stored in the compartment in a plastic bag.
- Do not keep anything valuable or breakable in the storage compartment.

To store a helmet in the storage compartment, place the helmet upside-down with the front facing forward.

TIP

- Some helmets cannot be stored in the storage compartment because of their size or shape.
- Do not leave your scooter unattended with the seat open.

EAU14832

Adjusting the shock absorber assembly (Depends on models)

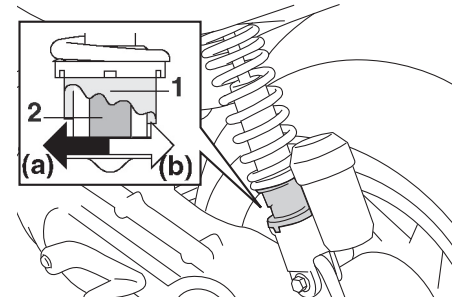

1. Spring preload adjusting ring
2. Position indicator

This shock absorber assembly is equipped with a spring preload adjusting ring.

NOTICE

ECA10101

To avoid damaging the mechanism, do not attempt to turn beyond the maximum or minimum settings.

INSTRUMENT AND CONTROL FUNCTIONS

Adjust the spring preload as follows. To increase the spring preload and thereby harden the suspension, turn the adjusting ring in direction (a). To decrease the spring preload and thereby soften the suspension, turn the adjusting ring in direction (b).

3

Align the appropriate notch in the adjusting ring with the position indicator on the shock absorber.

Spring preload setting:

Minimum (soft):

(b)

Standard:

middle

Maximum (hard):

(a)

EWA10221

⚠ WARNING

This shock absorber assembly contains highly pressurized nitrogen gas. Read and understand the following information before handling the shock absorber assembly.

- Do not tamper with or attempt to open the cylinder assembly.
- Do not subject the shock absorber assembly to an open

flame or other high heat source. This may cause the unit to explode due to excessive gas pressure.

- Do not deform or damage the cylinder in any way. Cylinder damage will result in poor damping performance.
- Do not dispose of a damaged or worn-out shock absorber assembly yourself. Take the shock absorber assembly to a Yamaha dealer for any service.

EAUT1072

Luggage hook

EWAT1031

⚠ WARNING

- Do not exceed the load limit of 1.5 kg (3.3 lb) for the luggage hook.
- Do not exceed the maximum load of CS50/CS50M 169 kg (373 lb) CS50Z 166 (366 lb) for the vehicle.

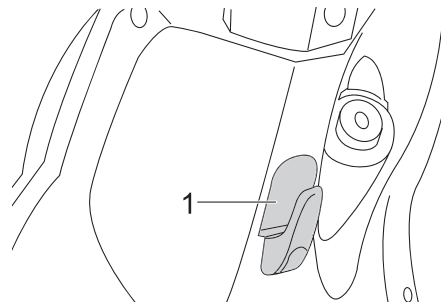

1. Luggage hook

FOR YOUR SAFETY – PRE-OPERATION CHECKS

EAU15595

Inspect your vehicle each time you use it to make sure the vehicle is in safe operating condition. Always follow the inspection and maintenance procedures and schedules described in the Owner's Manual.

EWA11151

WARNING

Failure to inspect or maintain the vehicle properly increases the possibility of an accident or equipment damage. Do not operate the vehicle if you find any problem. If a problem cannot be corrected by the procedures provided in this manual, have the vehicle inspected by a Yamaha dealer.

Before using this vehicle, check the following points:

FOR YOUR SAFETY – PRE-OPERATION CHECKS

EAU15605

Pre-operation check list

ITEM	CHECKS	PAGE
Fuel	<ul style="list-style-type: none">• Check fuel level in fuel tank.• Refuel if necessary.• Check fuel line for leakage.	3-8
2-stroke engine oil	<ul style="list-style-type: none">• Check oil level in oil tank.• If necessary, add recommended oil to specified level.• Check vehicle for oil leakage.	3-10
Final transmission oil	<ul style="list-style-type: none">• Check vehicle for oil leakage.	6-7
Coolant (CS50Z)	<ul style="list-style-type: none">• Check coolant level in reservoir.• If necessary, add recommended coolant to specified level.• Check cooling system for leakage.	6-8
Front brake	<ul style="list-style-type: none">• Check operation.• If soft or spongy, have Yamaha dealer bleed hydraulic system.• Check brake pads for wear.• Replace if necessary.• Check fluid level in reservoir.• If necessary, add recommended brake fluid to specified level.• Check hydraulic system for leakage.	6-13, 6-14, 6-15
Rear brake	<ul style="list-style-type: none">• Check operation.• Lubricate cable if necessary.• Check lever free play.• Adjust if necessary.	6-13, 6-14
Throttle grip	<ul style="list-style-type: none">• Make sure that operation is smooth.• Check cable free play.• If necessary, have Yamaha dealer adjust cable free play and lubricate cable and grip housing.	6-10, 6-16
Wheels and tires	<ul style="list-style-type: none">• Check for damage.• Check tire condition and tread depth.• Check air pressure.• Correct if necessary.	6-11, 6-12

4

FOR YOUR SAFETY – PRE-OPERATION CHECKS

ITEM	CHECKS	PAGE
Brake levers	<ul style="list-style-type: none">• Make sure that operation is smooth.• Lubricate lever pivoting points if necessary.	6-16
Centerstand	<ul style="list-style-type: none">• Make sure that operation is smooth.• Lubricate pivot if necessary.	6-17
Chassis fasteners	<ul style="list-style-type: none">• Make sure that all nuts, bolts and screws are properly tightened.• Tighten if necessary.	–
Instruments, lights, signals and switches	<ul style="list-style-type: none">• Check operation.• Correct if necessary.	–

OPERATION AND IMPORTANT RIDING POINTS

EAU15951

Read the Owner's Manual carefully to become familiar with all controls. If there is a control or function you do not understand, ask your Yamaha dealer.

EWA10271

WARNING

Failure to familiarize yourself with the controls can lead to loss of control, which could cause an accident or injury.

5



Starting a cold engine

EAU16562

ECA10250

NOTICE

See page 5-4 for engine break-in instructions prior to operating the vehicle for the first time.

1. Turn the key to “”, and when the oil level warning light comes on, turn it to “”.

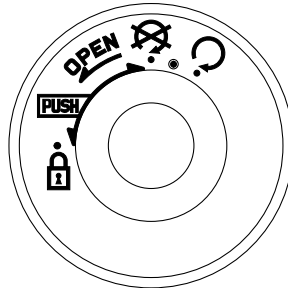

ECA10240

NOTICE

If the oil level warning light does not come on, have a Yamaha dealer check the electrical circuit.

2. Close the throttle completely.

3. While applying the front or rear brake, start the engine by pushing the start switch or by pushing the kickstarter lever down.
NOTICE: For maximum engine life, never accelerate hard when the engine is cold! [ECA11041]

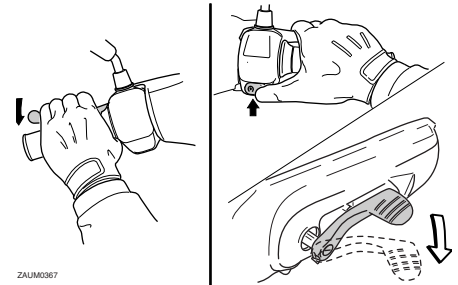

If the engine fails to start by pushing the start switch, release the switch, wait a few seconds, and then try again. Each starting attempt should be as short as possible to preserve the battery. Do not crank the engine more than 5 seconds on any one attempt. If the engine does not start with the starter motor, try using the kickstarter.

OPERATION AND IMPORTANT RIDING POINTS

EAU16761

Starting off

TIP

Before starting off, allow the engine to warm up.

1. While pulling the rear brake lever with your left hand and holding the grab bar with your right hand, push the scooter off the centerstand.

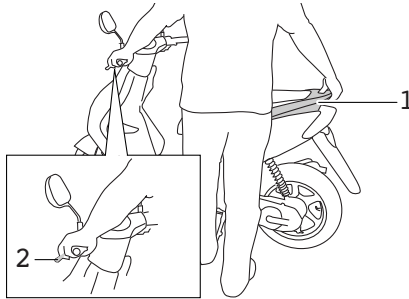

1. Grab bar
2. Rear brake lever

2. Sit astride the seat, and then adjust the rear view mirrors.
3. Switch the turn signals on.

4. Check for oncoming traffic, and then slowly turn the throttle grip (on the right) in order to take off.
5. Switch the turn signals off.

EAU16780

Acceleration and deceleration

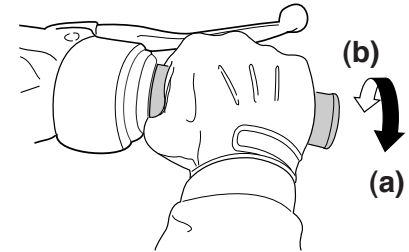

ZAUM0199

The speed can be adjusted by opening and closing the throttle. To increase the speed, turn the throttle grip in direction (a). To reduce the speed, turn the throttle grip in direction (b).

OPERATION AND IMPORTANT RIDING POINTS

EAU16793

EWA10300

Braking

⚠ WARNING

- Avoid braking hard or suddenly (especially when leaning over to one side), otherwise the scooter may skid or overturn.
- Railroad crossings, streetcar rails, iron plates on road construction sites, and manhole covers become extremely slippery when wet. Therefore, slow down when approaching such areas and cross them with caution.
- Keep in mind that braking on a wet road is much more difficult.
- Ride slowly down a hill, as braking downhill can be very difficult.

1. Close the throttle completely.
2. Apply both front and rear brakes simultaneously while gradually increasing the pressure.

Front

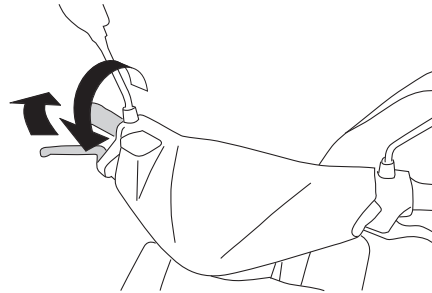

Rear

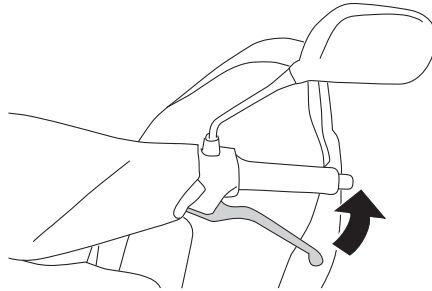

EAU16820

Tips for reducing fuel consumption

Fuel consumption depends largely on your riding style. Consider the following tips to reduce fuel consumption:

- Avoid high engine speeds during acceleration.
- Avoid high engine speeds with no load on the engine.
- Turn the engine off instead of letting it idle for an extended length of time (e.g., in traffic jams, at traffic lights or at railroad crossings).

EAU16830

Engine break-in

There is never a more important period in the life of your engine than the period between 0 and 1000 km (600 mi). For this reason, you should read the following material carefully.

Since the engine is brand new, do not put an excessive load on it for the first 1000 km (600 mi). The various parts in the engine wear and polish themselves to the correct operating clearances. During this period, prolonged full-throttle operation or any condition that might result in engine overheating must be avoided.

EAU17213

Parking

When parking, stop the engine, and then remove the key from the main switch.

EWA10311

WARNING

- **Since the engine and exhaust system can become very hot, park in a place where pedestrians or children are not likely to touch them and be burned.**
 - **Do not park on a slope or on soft ground, otherwise the vehicle may overturn, increasing the risk of a fuel leak and fire.**
 - **Do not park near grass or other flammable materials which might catch fire.**
-

PERIODIC MAINTENANCE AND ADJUSTMENT

EAU17281

Periodic inspection, adjustment, and lubrication will keep your vehicle in the safest and most efficient condition possible. Safety is an obligation of the vehicle owner/operator. The most important points of vehicle inspection, adjustment, and lubrication are explained on the following pages. The intervals given in the periodic maintenance and lubrication chart should be simply considered as a general guide under normal riding conditions. However, depending on the weather, terrain, geographical location, and individual use, the maintenance intervals may need to be shortened.

WARNING

EWA10321

Failure to properly maintain the vehicle or performing maintenance activities incorrectly may increase your risk of injury or death during service or while using the vehicle. If you are not familiar with vehicle service, have a Yamaha dealer perform service.

EWA15121

WARNING

Turn off the engine when performing maintenance unless otherwise specified.

- **A running engine has moving parts that can catch on body parts or clothing and electrical parts that can cause shocks or fires.**
 - **Running the engine while servicing can lead to eye injury, burns, fire, or carbon monoxide poisoning – possibly leading to death. See page 1-1 for more information about carbon monoxide.**
-

EWA10330

WARNING

This scooter is designed for use on paved roads only. If this scooter is operated in abnormally dusty, muddy or wet conditions, the air filter element should be cleaned or replaced more frequently, otherwise rapid engine wear may result. Consult a Yamaha dealer for proper maintenance intervals.

PERIODIC MAINTENANCE AND ADJUSTMENT

EAU17715

Periodic maintenance and lubrication chart

TIP

- The annual checks must be performed every year, except if a kilometer-based maintenance, or for the UK, a mileage-based maintenance, is performed instead.
- From 30000 km (17500 mi), repeat the maintenance intervals starting from 6000 km (3500 mi).
- Items marked with an asterisk should be performed by a Yamaha dealer as they require special tools, data and technical skills.

NO.	ITEM	CHECK OR MAINTENANCE JOB	ODOMETER READING					ANNUAL CHECK
			1000 km (600 mi)	6000 km (3500 mi)	12000 km (7000 mi)	18000 km (10500 mi)	24000 km (14000 mi)	
1	* Fuel line	<ul style="list-style-type: none"> • Check fuel and vacuum hoses for cracks or damage. 		√	√	√	√	√
2	Spark plug	<ul style="list-style-type: none"> • Replace. 		√	√	√	√	√
3	Air filter element	<ul style="list-style-type: none"> • Clean. 		√		√		
		<ul style="list-style-type: none"> • Replace. 			√		√	
4	* Front brake	<ul style="list-style-type: none"> • Check operation, fluid level and vehicle for fluid leakage. 	√	√	√	√	√	√
		<ul style="list-style-type: none"> • Replace brake pads. 	Whenever worn to the limit					
5	* Rear brake	<ul style="list-style-type: none"> • Check operation and adjust brake lever free play. 	√	√	√	√	√	√
		<ul style="list-style-type: none"> • Replace brake shoes. 	Whenever worn to the limit					
6	* Brake hose	<ul style="list-style-type: none"> • Check for cracks or damage. 		√	√	√	√	√
		<ul style="list-style-type: none"> • Replace. 	Every 4 years					

PERIODIC MAINTENANCE AND ADJUSTMENT

NO.	ITEM	CHECK OR MAINTENANCE JOB	ODOMETER READING					ANNUAL CHECK
			1000 km (600 mi)	6000 km (3500 mi)	12000 km (7000 mi)	18000 km (10500 mi)	24000 km (14000 mi)	
7	* Wheels	<ul style="list-style-type: none"> • Check runout and for damage. 		√	√	√	√	
8	* Tires	<ul style="list-style-type: none"> • Check tread depth and for damage. • Replace if necessary. • Check air pressure. • Correct if necessary. 		√	√	√	√	√
9	* Wheel bearings	<ul style="list-style-type: none"> • Check bearing for looseness or damage. 		√	√	√	√	
10	* Steering bearings	<ul style="list-style-type: none"> • Check bearing play and steering for roughness. 	√	√	√	√	√	
		<ul style="list-style-type: none"> • Lubricate with lithium-soap-based grease. 	Every 24000 km (14000 mi)					
11	* Chassis fasteners	<ul style="list-style-type: none"> • Make sure that all nuts, bolts and screws are properly tightened. 		√	√	√	√	√
12	Front brake lever pivot shaft	<ul style="list-style-type: none"> • Lubricate with silicone grease. 		√	√	√	√	√
13	Rear brake lever pivot shaft	<ul style="list-style-type: none"> • Lubricate with lithium-soap-based grease. 		√	√	√	√	√
14	Centerstand	<ul style="list-style-type: none"> • Check operation. • Lubricate. 		√	√	√	√	√
15	* Front fork	<ul style="list-style-type: none"> • Check operation and for oil leakage. 		√	√	√	√	
16	* Shock absorber assembly	<ul style="list-style-type: none"> • Check operation and shock absorber for oil leakage. 		√	√	√	√	
17	* Carburetor	<ul style="list-style-type: none"> • Adjust engine idling speed. 	√	√	√	√	√	√
18	* Autolube pump	<ul style="list-style-type: none"> • Check operation. • Bleed if necessary. 	√		√		√	√

PERIODIC MAINTENANCE AND ADJUSTMENT

NO.	ITEM	CHECK OR MAINTENANCE JOB	ODOMETER READING					ANNUAL CHECK
			1000 km (600 mi)	6000 km (3500 mi)	12000 km (7000 mi)	18000 km (10500 mi)	24000 km (14000 mi)	
19	* Cooling system (CS50Z)	<ul style="list-style-type: none"> • Check coolant level and vehicle for coolant leakage. • Change. 		√	√	√	√	√
20	Final transmission oil	<ul style="list-style-type: none"> • Check vehicle for oil leakage. • Change. 	√	√	√	√	√	√
21	* V-belt	<ul style="list-style-type: none"> • Replace. 	Every 10000 km (6000 mi)					
22	* Front and rear brake switches	<ul style="list-style-type: none"> • Check operation. 	√	√	√	√	√	√
23	Moving parts and cables	<ul style="list-style-type: none"> • Lubricate. 		√	√	√	√	√
24	* Throttle grip housing and cable	<ul style="list-style-type: none"> • Check operation and free play. • Adjust the throttle cable free play if necessary. • Lubricate the throttle grip housing and cable. 		√	√	√	√	√
25	* Lights, signals and switches	<ul style="list-style-type: none"> • Check operation. • Adjust headlight beam. 	√	√	√	√	√	√

EAUM2070

TIP

- The air filter needs more frequent service if you are riding in unusually wet or dusty areas.
- Hydraulic brake service
 - Regularly check and, if necessary, correct the brake fluid level.
 - Every two years change the brake fluid.
 - Replace the brake hoses every four years and if cracked or damaged.

PERIODIC MAINTENANCE AND ADJUSTMENT

Removing and installing the cowling and panel

EAU18740

this chapter. Refer to this section each time a cowling or panel needs to be removed and installed.

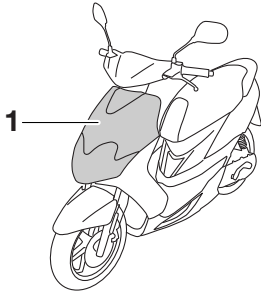

1. Cowling A

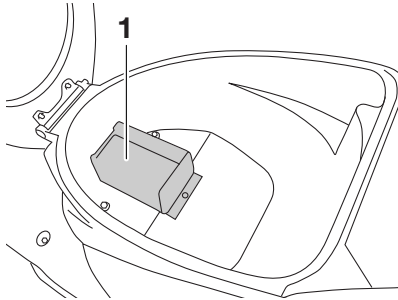

1. Panel A

The cowling and panel shown above need to be removed to perform some of the maintenance jobs described in

Cowling A

To remove the cowling

1. Remove the screws, and then pull the cowling off as shown.

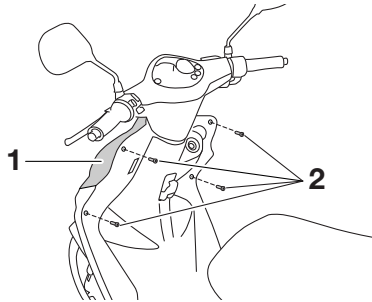

1. Cowling
2. Screw

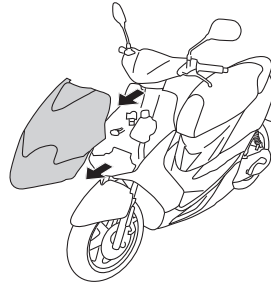

EAUS1520

2. Disconnect the headlight lead connectors, the turn signal couplers, and the auxiliary light couplers.

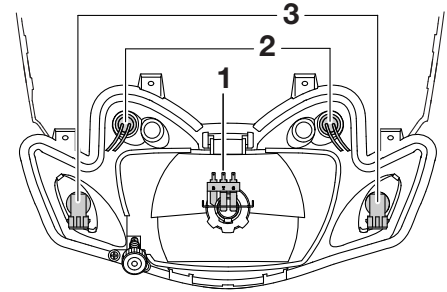

1. Headlight lead connector
2. Auxiliary light coupler
3. Turn signal coupler

To install the cowling

1. Connect the headlight leads connectors, the turn signal couplers, and the auxiliary light couplers.
2. Place the cowling in the original position, and then install the screws.

PERIODIC MAINTENANCE AND ADJUSTMENT

EAU1250

EAU19622

Panel A

To remove the panel

1. Open the storage compartment. (See page 3-11).
2. Remove the screw, and then take the panel off.

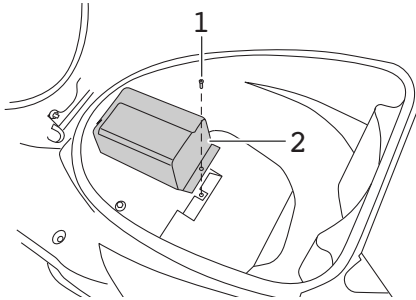

1. Screw
2. Panel A

To install the panel

1. Place the panel in the original position, and then install the screw.
2. Close the storage compartment.

Checking the spark plug

The spark plug is an important engine component, which should be checked periodically, preferably by a Yamaha dealer. Since heat and deposits will cause any spark plug to slowly erode, it should be removed and checked in accordance with the periodic maintenance and lubrication chart. In addition, the condition of the spark plug can reveal the condition of the engine.

The porcelain insulator around the center electrode of the spark plug should be a medium-to-light tan (the ideal color when the vehicle is ridden normally). If the spark plug shows a distinctly different color, the engine could be operating improperly. Do not attempt to diagnose such problems yourself. Instead, have a Yamaha dealer check the vehicle.

If the spark plug shows signs of electrode erosion and excessive carbon or other deposits, it should be replaced.

Specified spark plug:

NBR8HS/NGK (for CS50 CS50Z)
BPR4HS/NGK (for CS50M)

Before installing a spark plug, the spark plug gap should be measured with a wire thickness gauge and, if necessary, adjusted to specification.

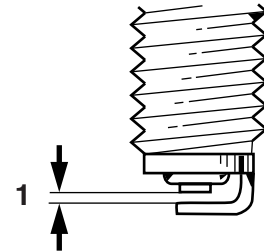

1. Spark plug gap

Spark plug gap:

0.6–0.7 mm (0.024–0.028 in)

Clean the surface of the spark plug gasket and its mating surface, and then wipe off any grime from the spark plug threads.

PERIODIC MAINTENANCE AND ADJUSTMENT

Tightening torque:

Spark plug:

20 Nm (2.0 m•kgf, 14.5 ft•lbf)

TIP

If a torque wrench is not available when installing a spark plug, a good estimate of the correct torque is 1/4–1/2 turn past finger tight. However, the spark plug should be tightened to the specified torque as soon as possible.

EAU20064

Final transmission oil

The final transmission case must be checked for oil leakage before each ride. If any leakage is found, have a Yamaha dealer check and repair the scooter. In addition, the final transmission oil must be changed as follows at the intervals specified in the periodic maintenance and lubrication chart.

1. Start the engine, warm up the final transmission oil by riding the scooter for several minutes, and then stop the engine.
2. Place the scooter on the centerstand.
3. Place an oil pan under the final transmission case to collect the used oil.
4. Remove the final transmission oil filler cap and final transmission drain bolt to drain the oil from the final transmission case.

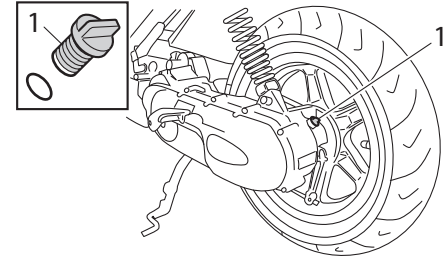

1. Final transmission oil filler cap

5. Install the final transmission oil drain bolt, and then tighten it to the specified torque.

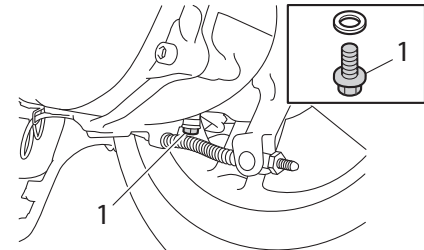

1. Final transmission oil drain bolt

PERIODIC MAINTENANCE AND ADJUSTMENT

Tightening torque:

Final transmission oil drain bolt:
18 Nm (1.8 m•kgf, 13.0 ft•lbf)

6. Refill with the specified amount of the recommended final transmission oil, and then install and tighten the oil filler cap. **WARNING! Make sure that no foreign material enters the final transmission case. Make sure that no oil gets on the tire or wheel.** [EWA11311]

Recommended final transmission oil:

See page 8-1

Oil quantity:

0.11 L (0.12 US qt, 0.10 Imp.qt)

7. Check the final transmission case for oil leakage. If oil is leaking, check for the cause.

EAUS1200

Coolant (CS50Z)

The coolant level should be checked before each ride. In addition, the coolant must be changed at the intervals specified in the periodic maintenance and lubrication chart.

EAUM2102

To check the coolant level

1. Place the vehicle on a level surface and hold it in an upright position.

TIP

- The coolant level must be checked on a cold engine since the level varies with engine temperature.
- Make sure that the vehicle is positioned straight up when checking the coolant level. A slight tilt to the side can result in a false reading.

2. Check the coolant level through the check window.

TIP

The coolant should be between the minimum and maximum level marks.

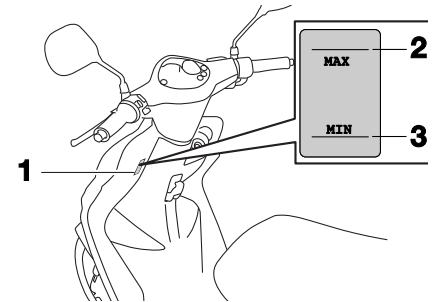

1. Coolant level check window
2. Maximum level mark
3. Minimum level mark

3. If the coolant is at or below the minimum level mark, remove the cowling A. (See page 6-5).
4. Open the reservoir cap, and then add coolant to the maximum level mark. **WARNING! Remove only the coolant reservoir cap. Never attempt to remove the radiator cap when the engine is hot.** [EWA15161]. **NOTICE: If coolant is not available, use distilled**

PERIODIC MAINTENANCE AND ADJUSTMENT

EAU40370

water or soft tap water instead. Do not use hard water or salt water since it is harmful to the engine. If water has been used instead of coolant, replace it with coolant as soon as possible, otherwise the cooling system will not be protected against frost and corrosion. If water has been added to the coolant, have a Yamaha dealer check the antifreeze content of the coolant as soon as possible, otherwise the effectiveness of the coolant will be reduced. [ECA10472]

Coolant reservoir capacity:
0.25 L (0.26 US qt, 0.22 Imp.qt)

5. Close the reservoir cap, and then install the cowling.

EAU33031

Changing the coolant

The coolant must be changed at the intervals specified in the periodic maintenance and lubrication chart. Have a Yamaha dealer change the coolant. **WARNING! Never attempt to remove the radiator cap when the engine is hot.** [EWA10381]

Air filter element

The air filter element must be cleaned and replaced at the intervals specified in the periodic maintenance and lubrication chart. Have a Yamaha dealer clean and replace the air filter element.

6

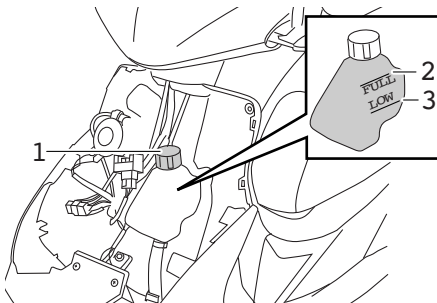

1. Coolant reservoir cap
2. Maximum level mark
3. Minimum level mark

PERIODIC MAINTENANCE AND ADJUSTMENT

EAU21300

Adjusting the carburetor

The carburetor is an important part of the engine and requires very sophisticated adjustment. Therefore, all carburetor adjustments should be left to a Yamaha dealer, who has the necessary professional knowledge and experience.

EAU21370

Adjusting the throttle cable free play

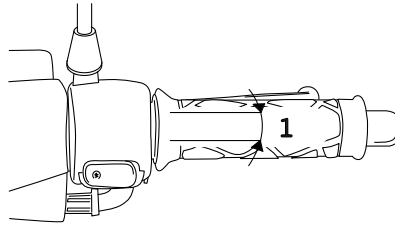

1. Throttle cable free play

The throttle cable free play should measure 2.0–5.0 mm (0.08–0.20 in) at the throttle grip. Periodically check the throttle cable free play and, if necessary, adjust it as follows.

TIP

The engine idling speed must be correctly adjusted before checking and adjusting the throttle cable free play.

1. Loosen the locknut.

2. To increase the throttle cable free play, turn the adjusting nut in direction (a). To decrease the throttle cable free play, turn the adjusting nut in direction (b).

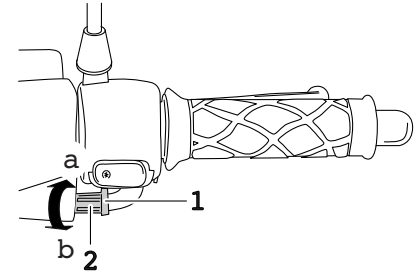

1. Locknut
2. Adjusting nut
3. Tighten the locknut.

PERIODIC MAINTENANCE AND ADJUSTMENT

EAU33601

Tires

To maximize the performance, durability, and safe operation of your vehicle, note the following points regarding the specified tires.

Tire air pressure

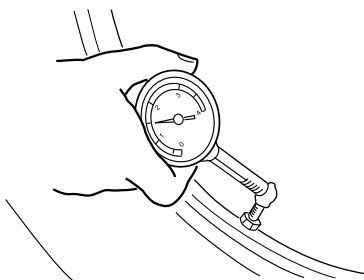

The tire air pressure should be checked and, if necessary, adjusted before each ride.

EWA10501

⚠ WARNING

Operation of this vehicle with improper tire pressure may cause severe injury or death from loss of control.

- **The tire air pressure must be checked and adjusted on cold tires (i.e., when the temperatu-**

re of the tires equals the ambient temperature).

- **The tire air pressure must be adjusted in accordance with the riding speed and with the total weight of rider, passenger, cargo, and accessories approved for this model.**

Tire air pressure (measured on

cold tires):

0–90 kg (0–198 lb):

Front:

175 kPa (1.75 kgf/cm², 25 psi,
1.75 bar)

Rear:

200 kPa (2.00 kgf/cm², 29 psi,
2.00 bar)

90 kg (198 lb) - maximum load:

Front:

175 kPa (1.75 kgf/cm², 25 psi,
1.75 bar)

Rear:

225 kPa (2.25 kgf/cm², 33 psi,
2.25 bar)

Maximum load*:

CS50/CS50M 169 kg (373 lb)

CS50Z 166 kg (366 lb)

* Total weight of rider, passenger,
cargo and accessories

EWA10511

⚠ WARNING

Never overload your vehicle. Operation of an overloaded vehicle could cause an accident.

Tire inspection

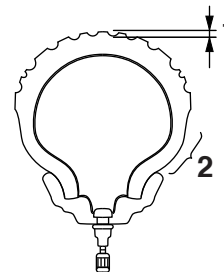

ZAUM0054

1. Tire wear indicator
2. Tire sidewall

The tires must be checked before each ride. If the center tread depth reaches the specified limit, if the tire has a nail or glass fragments in it, or if the sidewall is cracked, have a Yamaha dealer replace the tire immediately.

PERIODIC MAINTENANCE AND ADJUSTMENT

EWA10470

EAU21960

Minimum tire tread depth (front and rear):

1.6 mm (0.06 in)

TIP

The tire tread depth limits may differ from country to country. Always comply with the local regulations.

Tire information

This model is equipped with tubeless tires.

After extensive tests, only the tires listed below have been approved for this model by Yamaha Motor Co., Ltd

Front tire:

Size:

110/70-12 47L

Manufacturer/model:

CHENG SHIN TIRE / C922

Rear tire:

Size:

120/70-12 51L 130/70-12 56L

Manufacturer/model:

CHENG SHIN TIRE / C922

WARNING

- **Have a Yamaha dealer replace excessively worn tires. Besides being illegal, operating the vehicle with excessively worn tires decreases riding stability and can lead to loss of control.**
- **The replacement of all wheel and brake related parts, including the tires, should be left to a Yamaha dealer, who has the necessary professional knowledge and experience.**

Cast wheels

To maximize the performance, durability, and safe operation of your vehicle, note the following points regarding the specified wheels.

- The wheel rims should be checked for cracks, bends or warpage before each ride. If any damage is found, have a Yamaha dealer replace the wheel. Do not attempt even the smallest repair to the wheel. A deformed or cracked wheel must be replaced.
- The wheel should be balanced whenever either the tire or wheel has been changed or replaced. An unbalanced wheel can result in poor performance, adverse handling characteristics, and a shortened tire life.
- Ride at moderate speeds after changing a tire since the tire surface must first be “broken in” for it to develop its optimal characteristics.

PERIODIC MAINTENANCE AND ADJUSTMENT

EAUT1221

Checking the front brake lever free play

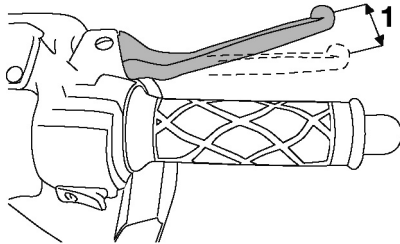

1. Front brake lever free play

The brake lever free play should measure 2.0–5.0 mm (0.08–0.20 in) as shown. Periodically check the brake lever free play and, if necessary, have a Yamaha dealer check the brake system.

EWA10641

⚠ WARNING

An incorrect brake lever free play indicates a hazardous condition in the brake system. Do not operate the vehicle until the brake system has been checked or repaired by a Yamaha dealer.

EAU22170

Adjusting the rear brake lever free play

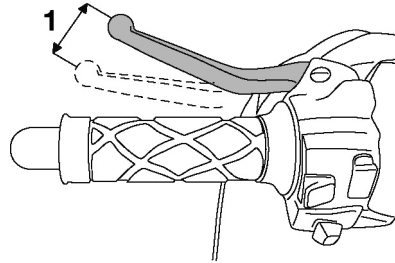

1. Rear brake lever free play

The brake lever free play should measure 5.0-10.0 mm (0.20-0.40 in) as shown. Periodically check the brake lever free play and, if necessary, adjust it as follows.

To increase the brake lever free play, turn the adjusting nut at the brake shoe plate in direction (a). To decrease the brake lever free play, turn the adjusting nut in direction (b).

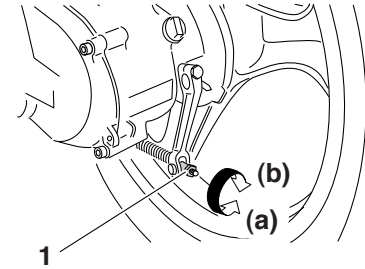

1. Adjusting nut

EWA10650

⚠ WARNING

If proper adjustment cannot be obtained as described, have a Yamaha dealer make this adjustment.

PERIODIC MAINTENANCE AND ADJUSTMENT

Checking the front brake pads and rear brake shoes

The front brake pads and the rear brake shoes must be checked for wear at the intervals specified in the periodic maintenance and lubrication chart.

EAU22380

Front brake pads

EAUS1510

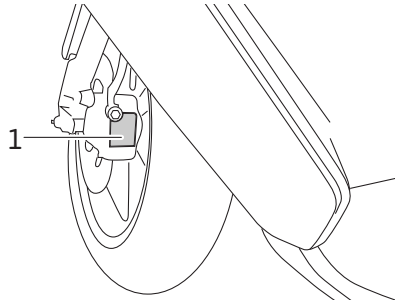

1. Brake pad checking cover

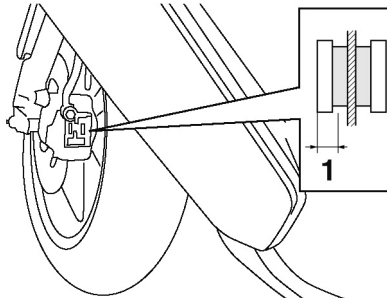

1. Lining thickness

Check each front brake pad for damage and measure the lining thickness. If a brake pad is damaged or if the lining thickness is less than 3.1 mm (0.12 in), have a Yamaha dealer replace the brake pads as a set.

Rear brake shoes

EAU22540

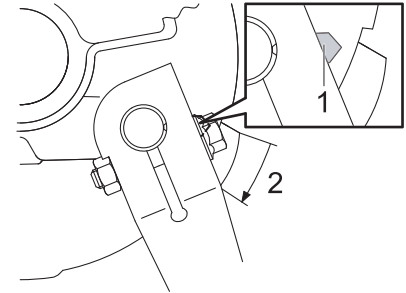

1. Wear indicator
2. Wear limit line

The rear brake is provided with a wear indicator, which allows you to check the brake shoe wear without having to disassemble the brake. To check the brake shoe wear, check the position of the wear indicator while applying the brake. If a brake shoe has worn to the point that the wear indicator reaches the wear limit line, have a Yamaha dealer replace the brake shoes as a set.

PERIODIC MAINTENANCE AND ADJUSTMENT

EAU32344

Checking the brake fluid level

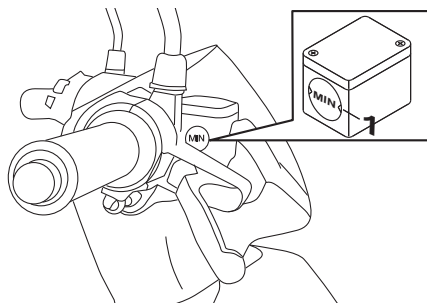

1. Minimum level mark

6

Insufficient brake fluid may allow air to enter the brake system, possibly causing it to become ineffective.

Before riding, check that the brake fluid is above the minimum level mark and replenish if necessary. A low brake fluid level may indicate worn brake pads and/or brake system leakage. If the brake fluid level is low, be sure to check the brake pads for wear and the brake system for leakage.

Observe these precautions:

- When checking the fluid level, make sure that the top of the master cylinder is level by turning the handlebars.
- Use only the recommended quality brake fluid, otherwise the rubber seals may deteriorate, causing leakage and poor braking performance.

Recommended brake fluid:
DOT 4

- Refill with the same type of brake fluid. Mixing fluids may result in a harmful chemical reaction and lead to poor braking performance.
- Be careful that water does not enter the master cylinder when refilling. Water will significantly lower the boiling point of the fluid and may result in vapor lock.

- Brake fluid may deteriorate painted surfaces or plastic parts. Always clean up spilled fluid immediately.
- As the brake pads wear, it is normal for the brake fluid level to gradually go down. However, if the brake fluid level goes down suddenly, have a Yamaha dealer check the cause.

PERIODIC MAINTENANCE AND ADJUSTMENT

EAU22721

Changing the brake fluid

Have a Yamaha dealer change the brake fluid at the intervals specified in the TIP after the periodic maintenance and lubrication chart. In addition, have the oil seals of the brake master cylinder and caliper as well as the brake hose replaced at the intervals listed below or whenever they are damaged or leaking.

- Oil seals: Replace every two years.
- Brake hose: Replace every four years.

EAU23111

Checking and lubricating the throttle grip and cable

The operation of the throttle grip should be checked before each ride. In addition, the cable should be lubricated at the intervals specified in the periodic maintenance chart.

EAU43641

Lubricating the front and rear brake levers

Front brake lever

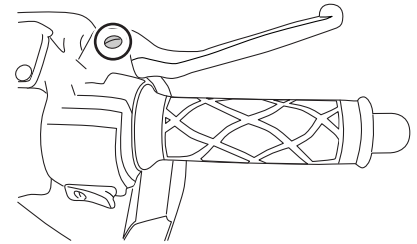

Rear brake lever

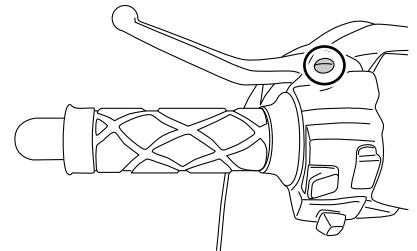

The pivoting points of the front and rear brake levers must be lubricated

PERIODIC MAINTENANCE AND ADJUSTMENT

at the intervals specified in the periodic maintenance and lubrication chart.

Recommended lubricants:

Front brake lever:
Silicone grease
Rear brake lever:
Lithium-soap-based grease

EAU23192

Checking and lubricating the centerstand

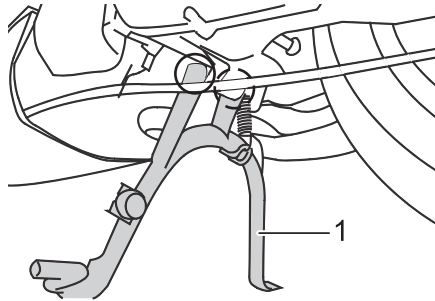

1. Centerstand

The operation of the centerstand should be checked before each ride, and the pivots and metal-to-metal contact surfaces should be lubricated if necessary.

EWA11301

WARNING

If the centerstand does not move up and down smoothly, have a Yamaha dealer check or repair it. Otherwise, the centerstand could contact the ground and distract the operator, resulting in a possible loss of control.

Recommended lubricant:
Lithium-soap-based grease

PERIODIC MAINTENANCE AND ADJUSTMENT

EAU23272

Checking the front fork

The condition and operation of the front fork must be checked as follows at the intervals specified in the periodic maintenance and lubrication chart.

To check the condition

1. Check the inner tubes for scratches, damage and excessive oil leakage.

To check the operation

1. Place the vehicle on a level surface and hold it in an upright position. **WARNING! To avoid injury, securely support the vehicle so there is no danger of it falling over.** [EWA10751]
2. While applying the front brake, push down hard on the handlebars several times to check if the front fork compresses and rebounds smoothly.

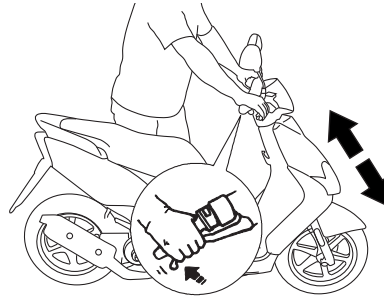

ECA10590

NOTICE

If any damage is found or the front fork does not operate smoothly, have a Yamaha dealer check or repair it.

EAU45511

Checking the steering

Worn or loose steering bearings may cause danger. Therefore, the operation of the steering must be checked as follows at the intervals specified in the periodic maintenance and lubrication chart.

1. Place the vehicle on the centers-stand. **WARNING! To avoid injury, securely support the vehicle so there is no danger of it falling over.** [EWA10751]
2. Hold the lower ends of the front fork legs and try to move them forward and backward. If any free play can be felt, have a Yamaha dealer check or repair the steering.

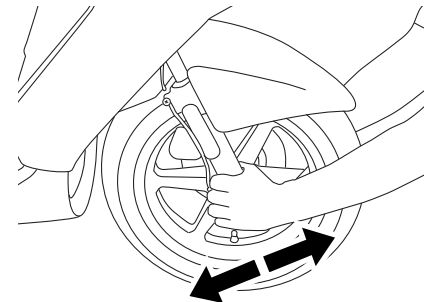

PERIODIC MAINTENANCE AND ADJUSTMENT

EAU23290

EAU23385

ECA10620

Checking the wheel bearings

The front and rear wheel bearings must be checked at the intervals specified in the periodic maintenance and lubrication chart. If there is play in the wheel hub or if the wheel does not turn smoothly, have a Yamaha dealer check the wheel bearings.

Battery

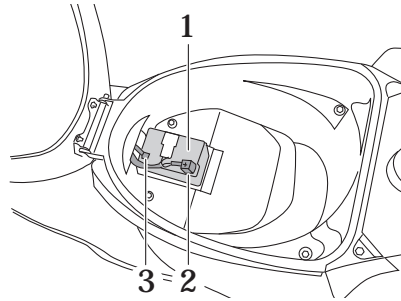

1. Battery
2. Positive battery lead (red)
3. Negative battery lead (black)

The battery is located behind panel A. (See page 6-5).

This model is equipped with a VRLA (Valve Regulated Lead Acid) battery. There is no need to check the electrolyte or to add distilled water. However, the battery lead connections need to be checked and, if necessary, tightened.

NOTICE

Never attempt to remove the battery cell seals, as this would permanently damage the battery.

WARNING

- **Electrolyte is poisonous and dangerous since it contains sulfuric acid, which causes severe burns. Avoid any contact with skin, eyes or clothing and always shield your eyes when working near batteries. In case of contact, administer the following FIRST AID.**
 - **EXTERNAL:** Flush with plenty of water.
 - **INTERNAL:** Drink large quantities of water or milk and immediately call a physician.
 - **EYES:** Flush with water for 15 minutes and seek prompt medical attention.
- **Batteries produce explosive hydrogen gas. Therefore, keep sparks, flames, cigarettes, etc., away from the battery and provide sufficient ventilation when**

PERIODIC MAINTENANCE AND ADJUSTMENT

EAU23503

charging it in an enclosed space.

- **KEEP THIS AND ALL BATTERIES OUT OF THE REACH OF CHILDREN.**

To charge the battery

1. Have a Yamaha dealer charge the battery as soon as possible if it seems to have discharged. Keep in mind that the battery tends to discharge more quickly if the vehicle is equipped with optional electrical accessories.

ECA16520

NOTICE

To charge a VRLA (Valve Regulated Lead Acid) battery, a special (constant-voltage) battery charger is required. Using a conventional battery charger will damage the battery. If you do not have access to a constant-voltage battery charger, have a Yamaha dealer charge your battery.

To store the battery

1. If the vehicle will not be used for more than one month, remove the battery, fully charge it, and then place it in a cool, dry place.
NOTICE: When removing the battery, be sure the key is turned to “⊗”, then disconnect the negative lead before disconnecting the positive lead. [ECA16302]
2. If the battery will be stored for more than two months, check it at least once a month and fully charge it if necessary.
3. Fully charge the battery before installation.
4. After installation, make sure that the battery leads are properly connected to the battery terminals.

ECA16530

NOTICE

Always keep the battery charged. Storing a discharged battery can cause permanent battery damage.

Replacing the fuse

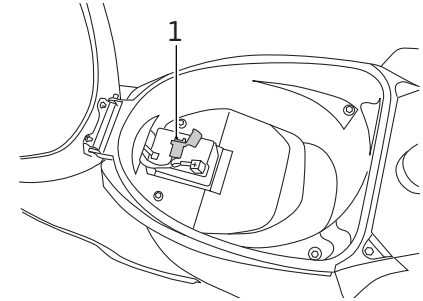

1. Main fuse

The fuse holder is located behind panel A. (See page 6-5).
If the fuse is blown, replace it as follows.

1. Turn the key to “⊗” and turn off all electrical circuits.
2. Remove the blown fuse, and then install a new fuse of the specified amperage. **WARNING! Do not use a fuse of a higher amperage rating than recommended to avoid causing extensive damage to the electrical system and possibly a fire.** [EWA15131]

PERIODIC MAINTENANCE AND ADJUSTMENT

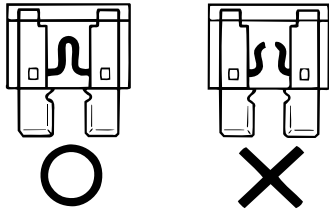

Specified fuse:
7.5 A

3. Turn the key to “○” and turn on the electrical circuits to check if the devices operate.
4. If the fuse immediately blows again, have a Yamaha dealer check the electrical system.

Replacing the headlight bulb or a front turn signal light bulb

EAS1433

If a bulb burns out, replace it as follows.

ECA10670

NOTICE

It is advisable to have a Yamaha dealer perform this job.

Headlight bulb

1. Remove cowling A. (See page 6-5).
2. Disconnect the headlight leads, and then unhook the headlight bulb retaining wire as shown.

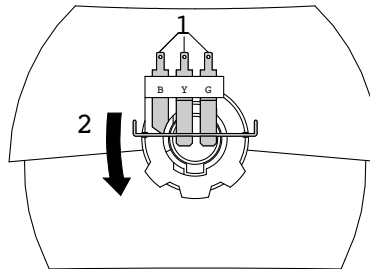

1. Headlight lead connector
2. Unhook

3. Remove the bulb holder by pulling it and then, remove the burnt-out bulb by turning it counterclockwise.

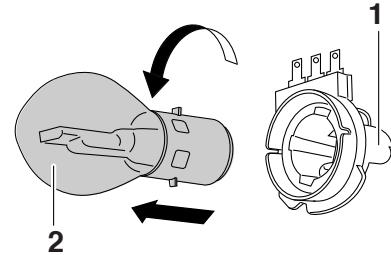

1. Headlight bulb cover
2. Headlight bulb

4. Insert a new headlight bulb into the bulb holder and turn it clockwise.

PERIODIC MAINTENANCE AND ADJUSTMENT

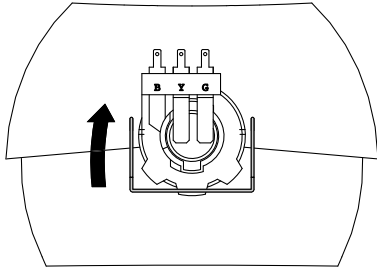

5. Place the bulb holder in its original position, and then secure it with the retaining wire as shown.
6. Connect the headlight leads and install the cowling.
7. Have a Yamaha dealer adjust the headlight beam if necessary.

Left turn signal light bulb

1. Remove cowling A. (See page 6-5).
2. Remove the socket (together with the bulb) by turning it counterclockwise.

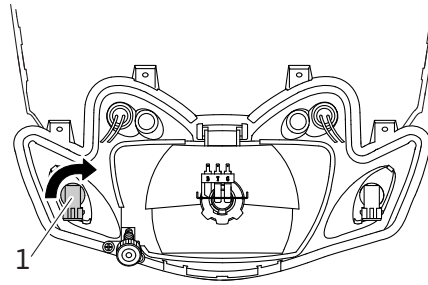

1. Socket

3. Remove the burnt-out bulb from the socket by pulling it out.

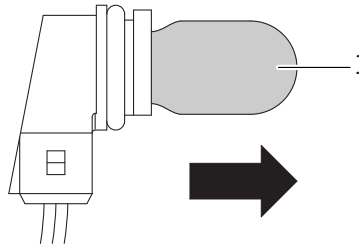

1. Turn signal light bulb

4. Insert a new bulb into the socket.
5. Install the socket by turning it clockwise.
6. Install the cowling.

Right turn signal light bulb

1. Remove cowling A. (See page 6-5).
2. Remove the socket (together with the bulb) by turning it clockwise.

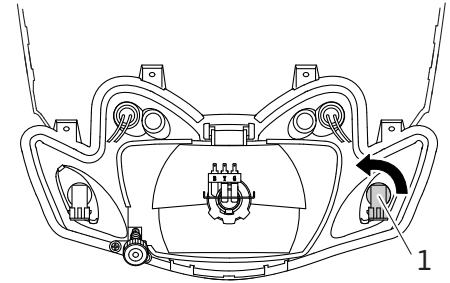

1. Socket

3. Remove the burnt-out bulb from the socket by pulling it out.
4. Insert a new bulb into the socket.
5. Install the socket by turning counterclockwise.
6. Install the cowling.

PERIODIC MAINTENANCE AND ADJUSTMENT

EAUT1923

Replacing the tail/brake light bulb or a rear turn signal light bulb

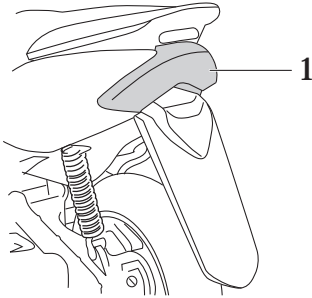

- 6 1. Tail/brake light lens

Tail/brake light bulb

1. Remove the tail/brake light lens by removing the screws.

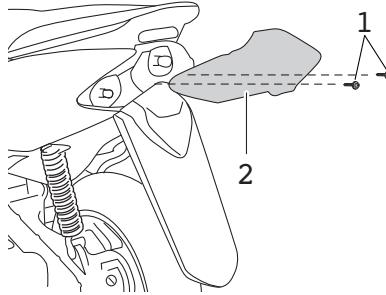

1. Screw
2. Tail/brake light lens

2. Remove the burnt out bulb by pushing it in and turning it counterclockwise.

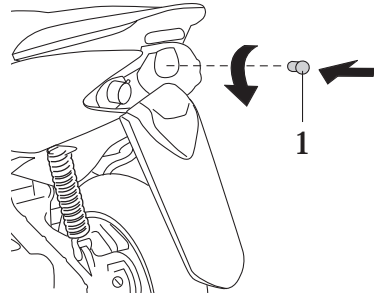

1. Tail/brake light bulb

3. Insert a new bulb into the socket, push it in, and then turn it clockwise until it stops.
4. Install the lens by installing the screws.

Rear turn signal light bulb

1. Remove the tail/brake light lens by removing the screws.

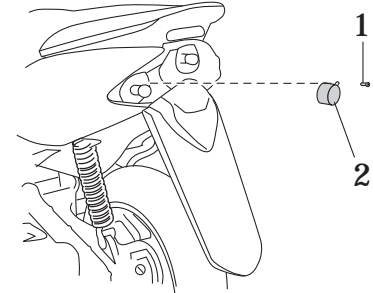

1. Screw
2. Turn signal light lens

2. Remove the turn signal light lens by removing the screw.

PERIODIC MAINTENANCE AND ADJUSTMENT

EAUS1151

EAUS1412

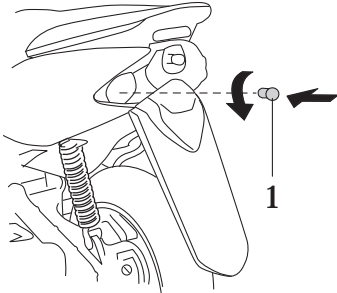

1. Turn signal light bulb

3. Remove the burnt out bulb by pushing it in and turning it counterclockwise.
4. Insert a new bulb into the socket, push it in, and then turn it clockwise until it stops.
5. Install the turn signal light lens by installing the screw.
6. Install the tail/brake light lens by installing the screws. **NOTICE: Do not overtighten the screws, otherwise the lens may break.**

[ECA10681]

Replacing the license plate light bulb (Depends on models)

1. Remove the lens by removing the screw.

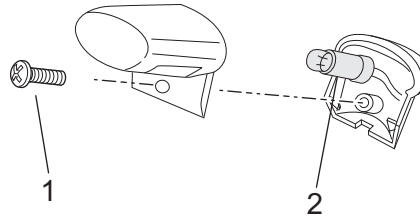

1. Screw
2. License plate light bulb socket

2. Remove the burnt out bulb by pulling it out.
3. Insert a new bulb into the socket.
4. Install the lens by installing the screw. **NOTICE: Do not overtighten the screw, otherwise the lens may break.** [ECA11191]

Replacing an auxiliary light bulb

This model is equipped with two auxiliary lights. If an auxiliary light bulb burns out, replace it as follows.

1. Remove cowling A. (See page 6-5).
2. Remove the auxiliary light socket (together with the bulb) by pulling it out.

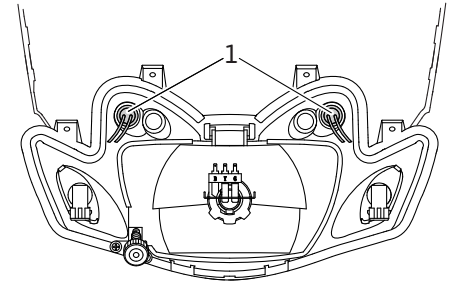

1. Auxiliary light bulb socket

3. Remove the burnt-out bulb by pulling it out.

PERIODIC MAINTENANCE AND ADJUSTMENT

EAU25881

EWA15141

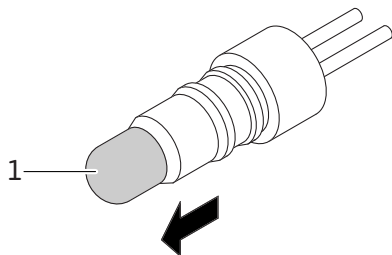

1. Auxiliary light bulb

4. Insert a new bulb into the socket.
5. Install the auxiliary light socket (together with the bulb) by pushing it in.
6. Install the cowling.

6

Troubleshooting

Although Yamaha scooters receive a thorough inspection before shipment from the factory, trouble may occur during operation. Any problem in the fuel, compression, or ignition systems, for example, can cause poor starting and loss of power.

The following troubleshooting charts represent quick and easy procedures for checking these vital systems yourself. However, should your scooter require any repair, take it to a Yamaha dealer, whose skilled technicians have the necessary tools, experience, and know-how to service the scooter properly.

Use only genuine Yamaha replacement parts. Imitation parts may look like Yamaha parts, but they are often inferior, have a shorter service life and can lead to expensive repair bills.

⚠ WARNING

When checking the fuel system, do not smoke, and make sure there are no open flames or sparks in the area, including pilot lights from water heaters or furnaces. Gasoline or gasoline vapors can ignite or explode, causing severe injury or property damage.

PERIODIC MAINTENANCE AND ADJUSTMENT

EAU25922

Troubleshooting charts

Starting problems or poor engine performance

1. Fuel

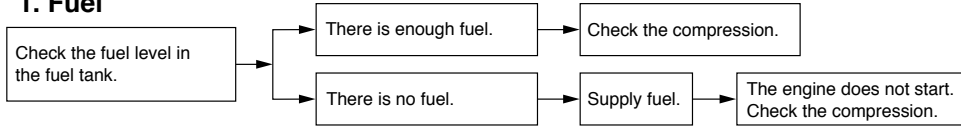

2. Compression

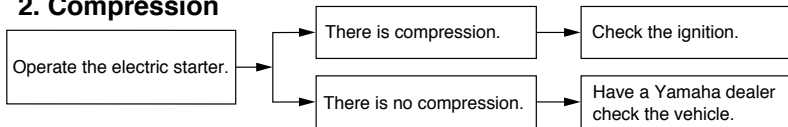

3. Ignition

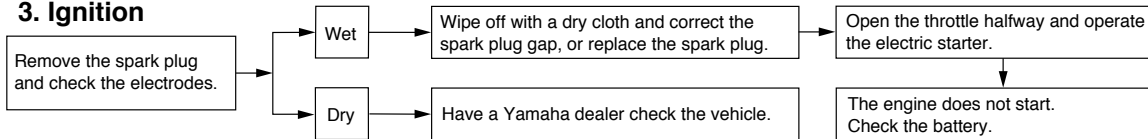

4. Battery

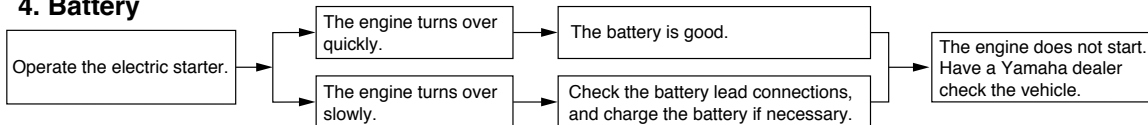

PERIODIC MAINTENANCE AND ADJUSTMENT

Engine overheating (CS50Z)

EWA10400

⚠ WARNING

- Do not remove the radiator cap when the engine and radiator are hot. Scalding hot fluid and steam may be blown out under pressure, which could cause serious injury. Be sure to wait until the engine has cooled.
- After removing the radiator cap retaining bolt, place a thick rag, like a towel, over the radiator cap, and then slowly rotate the cap counterclockwise to the detent to allow any residual pressure to escape. When the hissing sound has stopped, press down on the cap while turning it counterclockwise, and then remove the cap.

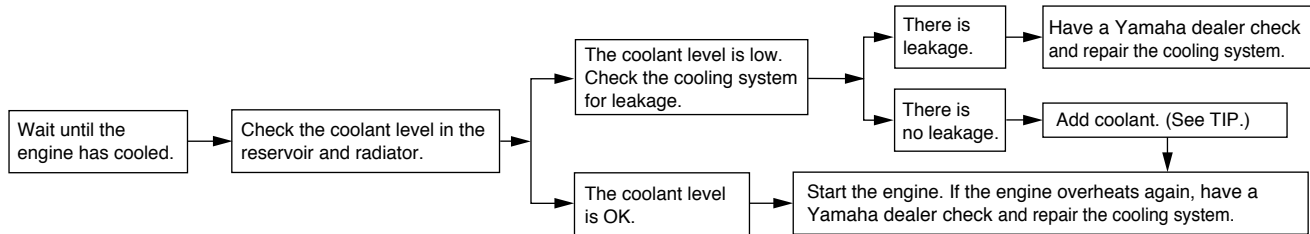

6

TIP

If coolant is not available, tap water can be temporarily used instead, provided that it is changed to the recommended coolant as soon as possible.

SCOOTER CARE AND STORAGE

Matte color caution

EAU37833

ECA15192

NOTICE

Some models are equipped with matte colored finished parts. Be sure to consult a Yamaha dealer for advice on what products to use before cleaning the vehicle.

Using a brush, harsh chemical products or cleaning compounds when cleaning these parts will scratch or damage their surface. Wax also should not be applied to any matte colored finished parts.

Care

EAU26092

While the open design of a scooter reveals the attractiveness of the technology, it also makes it more vulnerable. Rust and corrosion can develop even if high-quality components are used. A rusty exhaust pipe may go unnoticed on a car, however, it detracts from the overall appearance of a scooter. Frequent and proper care does not only comply with the terms of the warranty, but it will also keep your scooter looking good, extend its life and optimize its performance.

Before cleaning

1. Cover the muffler outlet with a plastic bag after the engine has cooled down.
2. Make sure that all caps and covers as well as all electrical couplers and connectors, including the spark plug cap, are tightly installed.
3. Remove extremely stubborn dirt, like oil burnt onto the crankcase, with a degreasing agent and a brush, but never apply such pro-

ducts onto seals, gaskets and wheel axles. Always rinse the dirt and degreaser off with water.

Cleaning

ECA10781

NOTICE

- Avoid using strong acidic wheel cleaners, especially on spoked wheels. If such products are used on hard-to-remove dirt, do not leave the cleaner on the affected area any longer than instructed. Also, thoroughly rinse the area off with water, immediately dry it, and then apply a corrosion protection spray.
- Improper cleaning can damage plastic parts such as cowlings, panels, windshields, headlight lenses, meter lenses, etc. Use only a soft, clean cloth or sponge with mild detergent and water to clean plastic.
- Do not use any harsh chemical products on plastic parts. Be sure to avoid using cloths or sponges which have been in contact with strong or abrasive

SCOOTER CARE AND STORAGE

cleaning products, solvent or thinner, fuel (gasoline), rust removers or inhibitors, brake fluid, antifreeze or electrolyte.

- **Do not use high-pressure washers or steam-jet cleaners since they cause water seepage and deterioration in the following areas: seals (of wheel and swingarm bearings, fork and brakes), electric components (couplers, connectors, instruments, switches and lights), breather hoses and vents.**
 - **For scooters equipped with a windshield: Do not use strong cleaners or hard sponges as they will cause dulling or scratching. Some cleaning compounds for plastic may leave scratches on the windshield. Test the product on a small hidden part of the windshield to make sure that it does not leave any marks. If the windshield is scratched, use a quality plastic polishing compound after washing.**
-

After normal use

1. Remove dirt with warm water, a mild detergent, and a soft, clean sponge, and then rinse thoroughly with clean water. Use a toothbrush or bottlebrush for hard-to-reach areas. Stubborn dirt and insects will come off more easily if the area is covered with a wet cloth for a few minutes before cleaning.

After riding in the rain, near the sea or on salt-sprayed roads

1. Since sea salt or salt sprayed on the roads during winter are extremely corrosive in combination with water, carry out the following steps after each ride in the rain, near the sea or on salt-sprayed roads.

TIP

Salt sprayed on roads in the winter may remain well into spring.

1. Clean the scooter with cold water and a mild detergent after the engine has cooled down. **NOTICE: Do not use warm water**

since it increases the corrosive action of the salt. [ECA10791]

2. Apply a corrosion protection spray on all metal, including chrome- and nickel-plated, surfaces to prevent corrosion.

After cleaning

1. Dry the scooter with a chamois or an absorbing cloth.
2. Use a chrome polish to shine chrome, aluminum and stainless-steel parts, including the exhaust system. (Even the thermally induced discoloring of stainless-steel exhaust systems can be removed through polishing.)
3. To prevent corrosion, it is recommended to apply a corrosion protection spray on all metal, including chrome- and nickel-plated, surfaces.
4. Use spray oil as a universal cleaner to remove any remaining dirt.
5. Touch up minor paint damage caused by stones, etc.
6. Wax all painted surfaces.
7. Let the scooter dry completely before storing or covering it.

SCOOTER CARE AND STORAGE

EWA10941

WARNING

Contaminants on the brakes or tires can cause loss of control.

- **Make sure that there is no oil or wax on the brakes or tires. If necessary, clean the brake discs and brake linings with a regular brake disc cleaner or acetone, and wash the tires with warm water and a mild detergent.**
- **Before operating the scooter test its braking performance and cornering behavior.**

ECA10800

NOTICE

- **Apply spray oil and wax sparingly and make sure to wipe off any excess.**
- **Never apply oil or wax to any rubber and plastic parts, but treat them with a suitable care product.**
- **Avoid using abrasive polishing compounds as they will wear away the paint.**

TIP

Consult a Yamaha dealer for advice on what products to use.

EAU26301

Storage

Short-term

Always store your scooter in a cool, dry place and, if necessary, protect it against dust with a porous cover.

ECA10820

NOTICE

- **Storing the scooter in a poorly ventilated room or covering it with a tarp, while it is still wet, will allow water and humidity to seep in and cause rust.**
- **To prevent corrosion, avoid damp cellars, stables (because of the presence of ammonia) and areas where strong chemicals are stored.**

Long-term

Before storing your scooter for several months:

1. Follow all the instructions in the “Care” section of this chapter.
2. Drain the carburetor float chamber by loosening the drain bolt; this will prevent fuel deposits from building up. Pour the drained fuel into the fuel tank.

SCOOTER CARE AND STORAGE

3. Fill up the fuel tank and add fuel stabilizer (if available) to prevent the fuel tank from rusting and the fuel from deteriorating.
4. Perform the following steps to protect the cylinder, piston rings, etc. from corrosion.
 - a. Remove the spark plug cap and spark plug.
 - b. Pour a teaspoonful of engine oil into the spark plug bore.
 - c. Install the spark plug cap onto the spark plug, and then place the spark plug on the cylinder head so that the electrodes are grounded. (This will limit sparking during the next step.)
 - d. Turn the engine over several times with the starter. (This will coat the cylinder wall with oil.) **WARNING! To prevent damage or injury from sparking, make sure to ground the spark plug electrodes while turning the engine over.**
 - e. Remove the spark plug cap from the spark plug, and then install the spark plug and the spark plug cap.
5. Lubricate all control cables and the pivoting points of all levers and pedals as well as of the sidestand/centerstand.
6. Check and, if necessary, correct the tire air pressure, and then lift the scooter so that both of its wheels are off the ground. Alternatively, turn the wheels a little every month in order to prevent the tires from becoming degraded in one spot.
7. Cover the muffler outlet with a plastic bag to prevent moisture from entering it.
8. Remove the battery and fully charge it. Store it in a cool, dry place and charge it once a month. Do not store the battery in an excessively cold or warm place [less than 0 °C (30 °F) or more than 30 °C (90 °F)]. For more information on storing the battery, see page 6-19.

TIP _____
Make any necessary repairs before storing the scooter.

SPECIFICATIONS

Dimensions:

Overall length:
1740 mm (68.5 in)
Overall width:
675 mm (26.6 in)
Overall height:
1065 mm (41.9 in)
Seat height:
770 mm (30.3 in)
Wheelbase:
1210 mm (47.6 in)
Ground clearance:
132 mm (5.20 in)

Weight:

With oil and fuel:
CS50/CS50M: 81.0 kg (178.6 lb)
CS50Z: 84.0 kg (185.2 lb)

Engine:

CS50/CS50M: Air cooled 2-stroke
CS50Z: Liquid cooled 2-stroke
Cylinder arrangement:
Forward-inclined single cylinder
Displacement:
49.2 cm³
Bore x stroke:
40.0 x 39.2 mm (1.57 x 1.54 in)
Compression ratio:
CS50: 11.60:1
CS50M: 10.10 :1
CS50Z: 11.40 :1
Starting system:
Electric starter and kickstarter
Lubrication system:
Separate lubrication (Yamaha autolube)

Type:

YAMALUBE 2 or 2-stroke engine oil

Engine oil quantity:

Quantity:
1.40 L (1.48 US qt, 1.23 Imp.qt)

Final transmission oil:

Type:
SAE10W30 type SE motor oil
Quantity:
0.11 L (0.12 US qt) (0.10 Imp.qt)

Cooling system (CS50Z):

Coolant reservoir capacity (up to the maximum level mark):
0.25 L (0.26 US qt) (0.22 Imp.qt)
Radiator capacity (including all routes):
0.91 L (0.96 US qt) (0.80 Imp.qt)

Air filter:

Air filter element:
Wet element

Fuel:

Recommended fuel:
Regular unleaded gasoline
Fuel tank capacity:
5.5 L (1.45 US gal, 1.21 Imp.gal)
Fuel reserve amount:
1.9 L (0.50 US gal, 0.42 Imp.gal)

Carburetor:

Manufacturer:
GURTNER
Type x quantity:
PY12

Spark plug(s):

Manufacturer/model:
CS50-CS50Z: NGK/BR8HS
CS50M: NGK/BPR4HS
Spark plug gap:
0.6-0.7 mm (0.024-0.028 in)

Clutch:

Clutch type:
Dry, centrifugal automatic

Transmission:

Primary reduction system:
Helical gear
Primary reduction ratio:
52/13 (4.000)
Secondary reduction system:
Spur gear
Secondary reduction ratio:
CS50: 42 x 13 (3.230)
CS50M: 45 x 12(3.750)
CS50Z: 43 x 13 (3.308)
Transmission type:
V-belt automatic
Operation:
Centrifugal automatic type

Chassis:

Frame type:
Steel tube underbone
Caster angle:
25.00 °
Trail:
80.0 mm (3.15 in)

Front tire:

Type:
Tubeless

SPECIFICATIONS

Size:
110/70-12 47L
Manufacturer/model:
CHENG SHIN TIRE / C922

Rear tire:

Type:
Tubeless
Size:
120/70-12 51L 130/70-12 56L
Manufacturer/model:
CHENG SHIN TIRE / C922

Loading:

Maximum load:
CS50/CS50M: 169 kg (372 lb)
CS50Z: 166 kg (366 lb)

Tire air pressure (measured on cold tires):

Loading condition:
0–90 kg (0–198 lb)
Front:
175 kPa (1.75 kgf/cm², 25 psi,
1.75 bar)
Rear:
200 kPa (2.00 kgf/cm², 29 psi,
2.00 bar)
90 kg (198 lb) - maximum load
Front:
175 kPa (1.75 kgf/cm², 25 psi,
1.75 bar)
Rear:
225 kPa (2.25 kgf/cm², 33 psi,
2.25 bar)

Front wheel:

Wheel type:
Cast wheel
Rim size:
MT 2.75X12

Rear wheel:

Wheel type:
Cast wheel
Rim size:
MT 3.00X12

Front brake:

Type:
Single disc brake
Operation:
Right hand operation
Recommended fluid:
DOT 4

Rear brake:

Type:
Drum brake
Operation:
Left hand operation

Front suspension:

Type:
Telescopic fork
Spring/shock absorber type:
Coil spring/oil damper
Wheel travel:
70.0 mm (2.76 in)

Rear suspension:

Type:
Unit swing

Spring/shock absorber type:
Coil spring/oil damper
Coil spring/gas-oil damper (depends on
models)
Wheel travel:
60.0 mm (2.36 in)

Electrical system:

Ignition system:
CDI
Charging system:
Flywheel magneto

Battery:

Model:
GT4L-BS
Voltage, capacity:
12 V, 4.0 Ah

Headlight:

Bulb type:
Incandescence

Bulb voltage, wattage x quantity:

Headlight:
12 V, 35 W/35.0 W x 1
Tail/brake light:
12 V, 21.0 W/5.0 W x 1
Front turn signal light:
12 V, 10.0 W x 2
Rear turn signal light:
12 V, 10.0 W x 2
Auxiliary light:
12 V, 5.0 W x 2
Meter lighting:
12 V, 1.2 W x 2
High beam indicator light:
12 V, 1.2 W x 1

Oil level warning light:

LED X 1

Turn signal indicator light:

12 V, 1.2 W x 2

Coolant temperature warning light (CS50Z):

LED x 1

Fuse:

Main fuse:

7.5 A

CONSUMER INFORMATION

EAU26351

Identification numbers

Record the key identification number, vehicle identification number and model label information in the spaces provided below for assistance when ordering spare parts from a Yamaha dealer or for reference in case the vehicle is stolen.

- KEY IDENTIFICATION NUMBER:

- VEHICLE IDENTIFICATION NUMBER:

- MODEL LABEL INFORMATION:

EAU26381

Key identification number

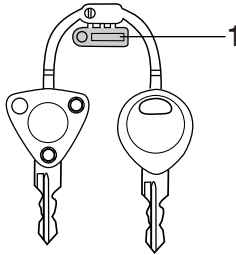

ZALUM0070

1. Key identification number

The key identification number is stamped into the key tag. Record this number in the space provided and use it for reference when ordering a new key.

EAU26410

Vehicle identification number

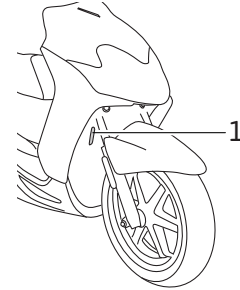

1. Vehicle identification number

The vehicle identification number is stamped into the frame.

TIP _____
The vehicle identification number is used to identify your vehicle and may be used to register it with the licensing authority in your area.

EAU26490

Model label

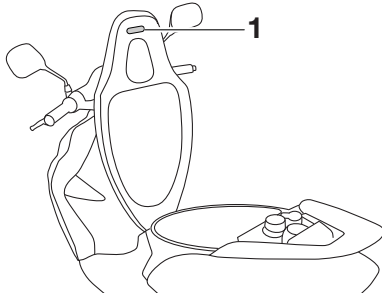

1. Model label

The model label is affixed to the bottom of the seat. (See page 3-11). Record the information on this label in the space provided. This information will be needed when ordering spare parts from a Yamaha dealer.

INDEX

- 2-stroke engine oil3-10
- A**
 - Acceleration and deceleration5-2
 - Air filter element6-9
 - Auxiliary light bulb, replacing.....6-24
- B**
 - Battery.....6-19
 - Brake fluid level, checking6-15
 - Brake fluid, changing6-16
 - Brake lever, front3-6
 - Brake lever, rear3-7
 - Brake levers, lubricating6-16
 - Brake pads and shoes, checking6-14
 - Braking.....5-3
- C**
 - Carburetor,adjusting.....6-10
 - Care.....7-1
 - Catalytic converter.....3-9
 - Centerstand, checking and lubricating....6-17
 - Coolant.....6-8
 - Cowling and panel, removing
and installing.....6-5
- D**
 - Dimmer switch3-6
- E**
 - Engine break-in.....5-4
- F**
 - Final transmission oil6-7
 - Front brake lever free play, checking.....6-13
 - Front fork, checking6-18
 - Fuel3-8
 - Fuel and 2-stroke engine oil tank caps3-7
 - Fuel consumption, tips for reducing.....5-3
 - Fuse, replacing.....6-20
- H**
 - Handlebar switches3-6
 - Headlight and front turn signal light
bulb, replacing.....6-21
 - High beam indicator light.....3-2
 - Horn switch.....3-6
- I**
 - Identification numbers9-1
 - Indicator and warning lights3-2
- K**
 - Key identification number9-1
 - Kickstarter.....3-10
- L**
 - License plate light bulb, replacing.....6-24
 - Luggage hook3-13
- M**
 - Main switch/steering lock3-1
 - Matte color, caution7-1
 - Model label9-2
 - Multi-function display3-4
- O**
 - Oil level warning light.....3-3
- P**
 - Parking5-4
 - Part locations1-5
 - Periodic maintenance and lubrication
chart.....6-2
 - Pre-operation check list.....4-2
- R**
 - Rear brake lever free play, adjusting6-13
 - Rider seat.....3-11
- S**
 - Safe-riding points.....1-5
 - Safety information.....1-1
- T**
 - Shock absorber assembly, adjusting.....3-12
 - Spark plug, checking6-6
 - Specifications.....7-3
 - Speedometer3-3
 - Start switch3-6
 - Starting a cold engine.....5-1
 - Starting off5-2
 - Steering, checking6-18
 - Storage.....7-3
 - Storage compartment.....3-11
- T**
 - Tail/brake light bulb or rear turn signal
light bulb, replacing6-23
 - Throttle cable free play, adjusting.....6-10
 - Throttle grip and cable, checking and
lubricating6-16
 - Tires6-11
 - Troubleshooting6-25
 - Troubleshooting charts6-26
 - Turn signal indicator lights3-2
 - Turn signal switch3-6
- V**
 - Vehicle identification number.....9-1
- W**
 - Wheel bearings, checking.....6-19
 - Wheels6-12



MBK Industrie

Z.I. de Rouvroy 02100 Saint Quentin

Société Anonyme au capital de 45 000 000 €

R.C St-Quentin B 329 035 422

PRINTED IN FRANCE
2012-03 (E)