



⚠ Read this manual carefully before operating this vehicle.

OWNER'S MANUAL



**CW50E**

2DW-F8199-E0



**Read this manual carefully before operating this vehicle. This manual should stay with this vehicle if it is sold.**

Welcome to the Yamaha world of motorcycling!

As the owner of the CW50E, you are benefiting from Yamaha's vast experience and newest technology regarding the design and manufacture of high-quality products, which have earned Yamaha a reputation for dependability.

Please take the time to read this manual thoroughly, so as to enjoy all advantages of your CW50E. The Owner's Manual does not only instruct you in how to operate, inspect and maintain your scooter, but also in how to safeguard yourself and others from trouble and injury.

In addition, the many tips given in this manual will help keep your scooter in the best possible condition. If you have any further questions, do not hesitate to contact your Yamaha dealer.

The Yamaha team wishes you many safe and pleasant rides. So, remember to put safety first!

Yamaha continually seeks advancements in product design and quality. Therefore, while this manual contains the most current product information available at the time of printing, there may be minor discrepancies between your scooter and this manual. If there is any question concerning this manual, please consult a Yamaha dealer.



---

**Please read this manual carefully and completely before operating this scooter.**

---



# IMPORTANT MANUAL INFORMATION

---

---

EAU10133

Particularly important information is distinguished in this manual by the following notations:

	<b>This is the safety alert symbol. It is used to alert you to potential personal injury hazards. Obey all safety messages that follow this symbol to avoid possible injury or death.</b>
	<b>A WARNING indicates a hazardous situation which, if not avoided, could result in death or serious injury.</b>
	<b>A NOTICE indicates special precautions that must be taken to avoid damage to the vehicle or other property.</b>
<b>TIP</b>	A TIP provides key information to make procedures easier or clearer.

\*Product and specifications are subject to change without notice.

# **IMPORTANT MANUAL INFORMATION**

---

---

EAUM1011

**CW50E  
OWNER'S MANUAL  
©2012 by MBK INDUSTRIE  
1st edition, December 2012  
All rights reserved  
Any reprinting or unauthorized use  
without the written permission of  
MBK INDUSTRIE  
is expressly prohibited.  
Printed in France.**

# TABLE OF CONTENTS

---

---

<b>SAFETY INFORMATION</b> .....	1-1
Further safe-riding points .....	1-5

<b>DESCRIPTION</b> .....	2-1
Left view .....	2-1
Right view .....	2-2

## **INSTRUMENT AND CONTROL**

<b>FUNCTIONS</b> .....	3-1
Main switch/steering lock .....	3-1
Indicator lights and warning lights .....	3-2
Speedometer unit .....	3-2
Fuel gauge .....	3-3
Handlebar switches .....	3-3
Front brake lever .....	3-4
Rear brake lever .....	3-4
Fuel and 2-stroke engine oil tank caps .....	3-5
Fuel .....	3-5
Catalytic converter .....	3-6
2-stroke engine oil .....	3-7
Kickstarter .....	3-7
Securing bracket .....	3-8
Seat .....	3-8
Anti-theft device housing .....	3-9
Luggage hook .....	3-9

<b>FOR YOUR SAFETY – PRE-OPERATION CHECKS</b> .....	4-1
---	-----

## **OPERATION AND IMPORTANT**

<b>RIDING POINTS</b> .....	5-1
Starting a cold engine .....	5-1
Starting off .....	5-2
Acceleration and deceleration .....	5-2
Braking .....	5-2
Tips for reducing fuel consumption .....	5-3
Engine break-in .....	5-3
Parking .....	5-4

## **PERIODIC MAINTENANCE AND**

<b>ADJUSTMENT</b> .....	6-1
Periodic maintenance chart for the emission control system .....	6-2
General maintenance and lubrication chart .....	6-3
Removing and installing the cowling and panels .....	6-6
Checking the spark plug .....	6-7
Final transmission oil .....	6-8
Cleaning the air filter element .....	6-9
Adjusting the carburetor .....	6-10
Checking the throttle grip free play .....	6-10
Tires .....	6-10
Panel wheels .....	6-12

Adjusting the front and rear brake lever free play .....	6-13
Checking the front and rear brake shoes .....	6-14
Checking and lubricating the cables .....	6-14
Checking and lubricating the throttle grip and cable .....	6-15
Lubricating the front and rear brake levers .....	6-15
Checking and lubricating the centerstand .....	6-15
Checking the front fork .....	6-16
Checking the steering .....	6-17
Checking the wheel bearings .....	6-17
Battery .....	6-17
Replacing the fuse .....	6-19
Replacing a headlight bulb .....	6-20
Replacing the tail/brake light bulb .....	6-20
Replacing a turn signal light bulb .....	6-21
Troubleshooting .....	6-21
Troubleshooting chart .....	6-22

## **SCOOTER CARE AND STORAGE**...

Matte color caution .....	7-1
Care .....	7-1
Storage .....	7-4

# **TABLE OF CONTENTS**

---

---

**SPECIFICATIONS** ..... 8-1

**CONSUMER INFORMATION**..... 9-1

    Identification numbers ..... 9-1

# SAFETY INFORMATION

EAUT1018

1

## Be a Responsible Owner

As the vehicle's owner, you are responsible for the safe and proper operation of your scooter.

Scooters are single-track vehicles.

Their safe use and operation are dependent upon the use of proper riding techniques as well as the expertise of the operator. Every operator should know the following requirements before riding this scooter.

He or she should:

- Obtain thorough instructions from a competent source on all aspects of scooter operation.
- Observe the warnings and maintenance requirements in this Owner's Manual.
- Obtain qualified training in safe and proper riding techniques.
- Obtain professional technical service as indicated in this Owner's Manual and/or when made necessary by mechanical conditions.

- Never operate a scooter without proper training or instruction. Take a training course. Beginners should receive training from a certified instructor. Contact an authorized scooter dealer to find out about the training courses nearest you.

## Safe Riding

Perform the pre-operation checks each time you use the vehicle to make sure it is in safe operating condition. Failure to inspect or maintain the vehicle properly increases the possibility of an accident or equipment damage. See page 4-1 for a list of pre-operation checks.

- This scooter is designed to carry the operator and a passenger.

## TIP

Although this scooter is designed to carry a passenger, always comply with the local regulations.

- The failure of motorists to detect and recognize scooters in traffic is the predominating cause of automobile/scooter accidents. Many accidents have been caused by an

automobile driver who did not see the scooter. Making yourself conspicuous appears to be very effective in reducing the chance of this type of accident.

## Therefore:

- Wear a brightly colored jacket.
- Use extra caution when you are approaching and passing through intersections, since intersections are the most likely places for scooter accidents to occur.
- Ride where other motorists can see you. Avoid riding in another motorist's blind spot.
- Never maintain a scooter without proper knowledge. Contact an authorized scooter dealer to inform you on basic scooter maintenance. Certain maintenance can only be carried out by certified staff.



- Many accidents involve inexperienced operators. In fact, many operators who have been involved in accidents do not even have a current driver's license.
  - Make sure that you are qualified and that you only lend your scooter to other qualified operators.
  - Know your skills and limits. Staying within your limits may help you to avoid an accident.
  - We recommend that you practice riding your scooter where there is no traffic until you have become thoroughly familiar with the scooter and all of its controls.
- Many accidents have been caused by error of the scooter operator. A typical error made by the operator is veering wide on a turn due to excessive speed or undercornering (insufficient lean angle for the speed).
  - Always obey the speed limit and never travel faster than warranted by road and traffic conditions.
  - Always signal before turning or changing lanes. Make sure that other motorists can see you.
- The posture of the operator and passenger is important for proper control.
  - The operator should keep both hands on the handlebar and both feet on the operator footrests during operation to maintain control of the scooter.
  - The passenger should always hold onto the operator, the seat strap or grab bar, if equipped, with both hands and keep both feet on the passenger footrests. Never carry a passenger unless he or she can firmly place both feet on the passenger footrests.
- Never ride under the influence of alcohol or other drugs.
- This scooter is designed for on-road use only. It is not suitable for off-road use.

### **Protective Apparel**

The majority of fatalities from scooter accidents are the result of head injuries. The use of a safety helmet is the single most critical factor in the prevention or reduction of head injuries.

- Always wear an approved helmet.
- Wear a face shield or goggles. Wind in your unprotected eyes could contribute to an impairment of vision that could delay seeing a hazard.
- The use of a jacket, substantial shoes, trousers, gloves, etc., is effective in preventing or reducing abrasions or lacerations.
- Never wear loose-fitting clothes, otherwise they could catch on the control levers or wheels and cause injury or an accident.
- Always wear protective clothing that covers your legs, ankles, and feet. The engine or exhaust system become very hot during or after operation and can cause burns.
- A passenger should also observe the above precautions.

# SAFETY INFORMATION

1

## **Avoid Carbon Monoxide Poisoning**

All engine exhaust contains carbon monoxide, a deadly gas. Breathing carbon monoxide can cause headaches, dizziness, drowsiness, nausea, confusion, and eventually death.

Carbon Monoxide is a colorless, odorless, tasteless gas which may be present even if you do not see or smell any engine exhaust. Deadly levels of carbon monoxide can collect rapidly and you can quickly be overcome and unable to save yourself. Also, deadly levels of carbon monoxide can linger for hours or days in enclosed or poorly ventilated areas. If you experience any symptoms of carbon monoxide poisoning, leave the area immediately, get fresh air, and **SEEK MEDICAL TREATMENT**.

- Do not run engine indoors. Even if you try to ventilate engine exhaust with fans or open windows and doors, carbon monoxide can rapidly reach dangerous levels.
- Do not run engine in poorly ventilated or partially enclosed areas such as barns, garages, or carports.

- Do not run engine outdoors where engine exhaust can be drawn into a building through openings such as windows and doors.

## **Loading**

Adding accessories or cargo to your scooter can adversely affect stability and handling if the weight distribution of the scooter is changed. To avoid the possibility of an accident, use extreme caution when adding cargo or accessories to your scooter. Use extra care when riding a scooter that has added cargo or accessories. Here, along with the information about accessories below, are some general guidelines to follow if loading cargo to your scooter:

The total weight of the operator, passenger, accessories and cargo must not exceed the maximum load limit.

**Operation of an overloaded vehicle could cause an accident.**

<p><b>Maximum load:</b> 185 kg (408 lb)</p>
---

When loading within this weight limit, keep the following in mind:

- Cargo and accessory weight should be kept as low and close to the scooter as possible. Securely pack your heaviest items as close to the center of the vehicle as possible and make sure to distribute the weight as evenly as possible on both sides of the scooter to minimize imbalance or instability.
- Shifting weights can create a sudden imbalance. Make sure that accessories and cargo are securely attached to the scooter before riding. Check accessory mounts and cargo restraints frequently.
  - Properly adjust the suspension for your load (suspension-adjustable models only), and check the condition and pressure of your tires.
  - Never attach any large or heavy items to the handlebar, front fork, or front fender. Such items can create unstable handling or a slow steering response.
- **This vehicle is not designed to pull a trailer or to be attached to a sidecar.**

### **Genuine Yamaha Accessories**

Choosing accessories for your vehicle is an important decision. Genuine Yamaha accessories, which are available only from a Yamaha dealer, have been designed, tested, and approved by Yamaha for use on your vehicle.

Many companies with no connection to Yamaha manufacture parts and accessories or offer other modifications for Yamaha vehicles. Yamaha is not in a position to test the products that these aftermarket companies produce. Therefore, Yamaha can neither endorse nor recommend the use of accessories not sold by Yamaha or modifications not specifically recommended by Yamaha, even if sold and installed by a Yamaha dealer.

### **Aftermarket Parts, Accessories, and Modifications**

While you may find aftermarket products similar in design and quality to genuine Yamaha accessories, recognize that some aftermarket accessories or modifications are not suitable because of potential safety hazards to you or others. Installing aftermarket prod-

ucts or having other modifications performed to your vehicle that change any of the vehicle's design or operation characteristics can put you and others at greater risk of serious injury or death. You are responsible for injuries related to changes in the vehicle.

Keep the following guidelines in mind, as well as those provided under "Loading" when mounting accessories.

- Never install accessories or carry cargo that would impair the performance of your scooter. Carefully inspect the accessory before using it to make sure that it does not in any way reduce ground clearance or cornering clearance, limit suspension travel, steering travel or control operation, or obscure lights or reflectors.
- Accessories fitted to the handlebar or the front fork area can create instability due to improper weight distribution or aerodynamic changes. If accessories are added to the handlebar or front fork area, they must be as lightweight as possible and should be kept to a minimum.

- Bulky or large accessories may seriously affect the stability of the scooter due to aerodynamic effects. Wind may attempt to lift the scooter, or the scooter may become unstable in cross winds. These accessories may also cause instability when passing or being passed by large vehicles.
- Certain accessories can displace the operator from his or her normal riding position. This improper position limits the freedom of movement of the operator and may limit control ability, therefore, such accessories are not recommended.
- Use caution when adding electrical accessories. If electrical accessories exceed the capacity of the scooter's electrical system, an electric failure could result, which could cause a dangerous loss of lights or engine power.

# SAFETY INFORMATION

1

## Aftermarket Tires and Rims

The tires and rims that came with your scooter were designed to match the performance capabilities and to provide the best combination of handling, braking, and comfort. Other tires, rims, sizes, and combinations may not be appropriate. Refer to page 6-10 for tire specifications and more information on replacing your tires.

## Transporting the Scooter

Be sure to observe following instructions before transporting the scooter in another vehicle.

- Remove all loose items from the scooter.
- Point the front wheel straight ahead on the trailer or in the truck bed, and choke it in a rail to prevent movement.
- Secure the scooter with tie-downs or suitable straps that are attached to solid parts of the scooter, such as the frame or upper front fork triple clamp (and not, for example, to rubber-mounted handlebars or turn signals, or parts that could break). Choose the location for the

straps carefully so the straps will not rub against painted surfaces during transport.

- The suspension should be compressed somewhat by the tie-downs, if possible, so that the scooter will not bounce excessively during transport.

EAUT2031

## Further safe-riding points

- Make sure to signal clearly when making turns.
- Braking can be extremely difficult on a wet road. Avoid hard braking, because the scooter could slide. Apply the brakes slowly when stopping on a wet surface.
- Slow down as you approach a corner or turn. Once you have completed a turn, accelerate slowly.
- Be careful when passing parked cars. A driver might not see you and open a door in your path.
- Railroad crossings, streetcar rails, iron plates on road construction sites, and manhole covers become extremely slippery when wet. Slow down and cross them with caution. Keep the scooter upright, otherwise it could slide out from under you.
- The brake lining could get wet when you wash the scooter. After washing the scooter, check the brakes before riding.

- Always wear a helmet, gloves, trousers (tapered around the cuff and ankle so they do not flap), and a bright colored jacket.
- Do not carry too much luggage on the scooter. An overloaded scooter is unstable.

# DESCRIPTION

EAU10410

## Left view

2

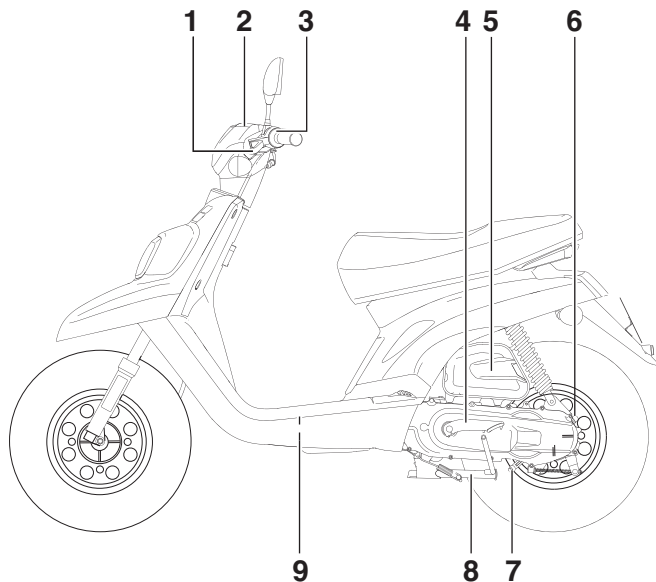

1. Rear brake lever (page 3-4)
2. Speedometer unit (page 3-2)
3. Left handlebar switches (page 3-3)
4. Kickstarter (page 3-7)
5. Air filter element (page 6-9)
6. Final transmission oil filler cap (page 6-8)
7. Final transmission oil drain bolt (page 6-8)
8. Centerstand (page 6-15)

9. Battery/fuse (page 6-17/6-19)

## Right view

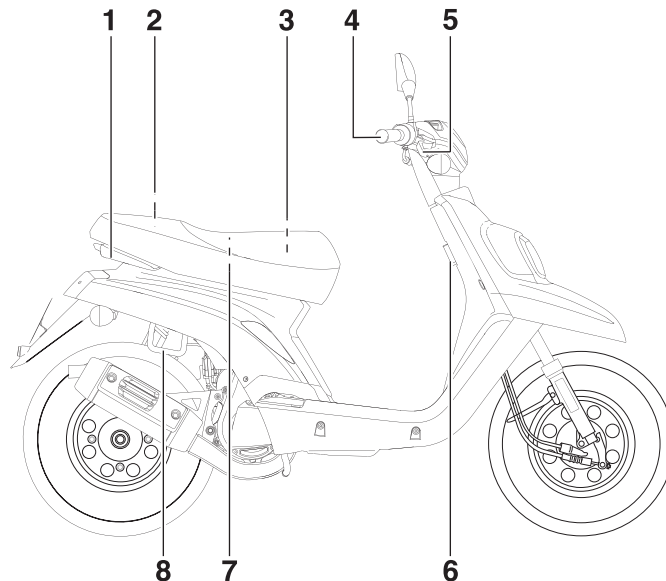

1. Grab bar (page 5-2)
2. Oil tank cap (page 3-7)
3. Fuel tank cap (page 3-5)
4. Throttle grip (page 6-10)
5. Front brake lever (page 3-4)
6. Luggage hook (page 3-9)
7. Anti-theft device housing (page 3-9)
8. Securing bracket (page 3-8)

# INSTRUMENT AND CONTROL FUNCTIONS

## Main switch/steering lock

EAU10461

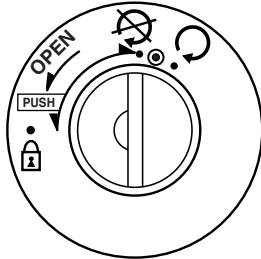

The main switch/steering lock controls the ignition and lighting systems, and is used to lock the steering. The various positions are described below.

### ON “○”

EAU10640

All electrical circuits are supplied with power, and the engine can be started. The key cannot be removed.

### TIP

The headlight, meter lighting and tail-light come on automatically when the engine is started.

### OFF “⊗”

EAU10661

All electrical systems are off. The key can be removed.

### ⚠ WARNING

EWA10061

Never turn the key to “⊗” or “⊔” while the vehicle is moving. Otherwise the electrical systems will be switched off, which may result in loss of control or an accident.

### CHECK “●”

EAU10670

The 2-stroke engine oil level warning light should come on. (See page 3-2.)

### LOCK “⊔”

EAU10684

The steering is locked, and all electrical systems are off. The key can be removed.

### To lock the steering

1. Turn the handlebars all the way to the left.
2. Push the key in from the “⊗” position, and then turn it to “⊔” while still pushing it.
3. Remove the key.

### To unlock the steering

Push the key in, and then turn it to “⊗” while still pushing it.



## Indicator lights and warning lights

EAU49392

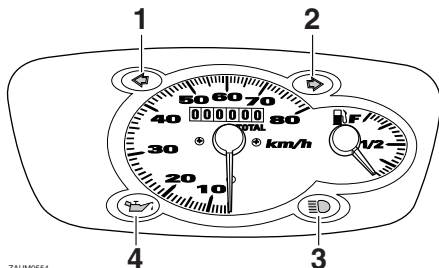

ZAJUM054

1. Left turn signal indicator light “←”
2. Right turn signal indicator light “→”
3. High beam indicator light “≡”
4. Oil level warning light “🛢️”

## Turn signal indicator lights “←” and “→”

EAU11030

The corresponding indicator light flashes when the turn signal switch is pushed to the left or right.

## High beam indicator light “≡”

EAU11080

This indicator light comes on when the high beam of the headlight is switched on.

## Oil level warning light “🛢️”

EAU11181

This warning light comes on when the key is in the “🔑” position or if the oil level in the 2-stroke engine oil tank is low during operation. If the warning light comes on during operation, stop immediately and fill the oil tank with Yamalube 2 or equivalent 2-stroke engine oil of either JASO grade “FC” or ISO grades “EG-C” or “EG-D”. The warning light should go off after the 2-stroke engine oil tank has been refilled.

### TIP

If the warning light does not come on when the key is in the “🔑” position or does not go off after the 2-stroke engine oil tank has been refilled, have a Yamaha dealer check the electrical circuit.

### NOTICE

**Do not operate the vehicle until you know that the engine oil level is sufficient.**

ECA16291

## Speedometer unit

EAU11621

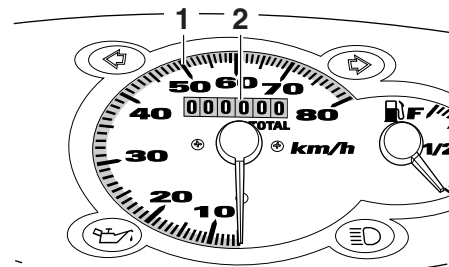

ZAJUM055

1. Speedometer
2. Odometer

### UK ONLY

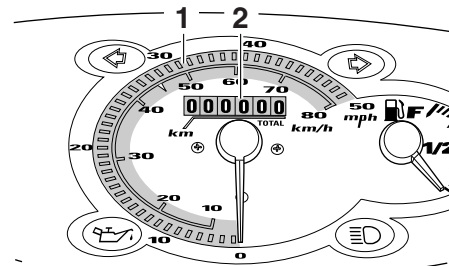

ZAJUM059

1. Speedometer
2. Odometer

# INSTRUMENT AND CONTROL FUNCTIONS

The speedometer unit is equipped with a speedometer and an odometer. The speedometer shows riding speed. The odometer shows the total distance traveled.

3

## Fuel gauge

EAU12111

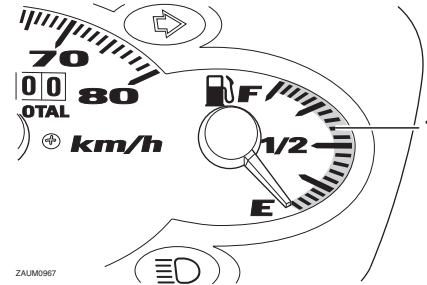

1. Fuel gauge



The fuel gauge indicates the amount of fuel in the fuel tank. The needle moves towards “E” (Empty) as the fuel level decreases. When the needle reaches “E”, approximately 0.7 L (0.18 US gal, 0.15 Imp.gal) of fuel remain in the fuel tank. If this occurs, refuel as soon as possible.

## Handlebar switches

EAU1234B

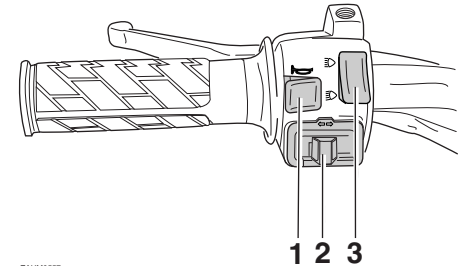

### Left



1. Horn switch “”
2. Turn signal switch “/”
3. Dimmer switch “/”



### Dimmer switch “/”

EAU12400

Set this switch to “” for the high beam and to “” for the low beam.

### Turn signal switch “/”

EAU12460

To signal a right-hand turn, push this switch to “”. To signal a left-hand turn, push this switch to “”. When released, the switch returns to the center position. To cancel the turn signal lights, push the switch in after it has returned to the center position.

# INSTRUMENT AND CONTROL FUNCTIONS

## Horn switch “”

Press this switch to sound the horn.

EAU12500

## Front brake lever

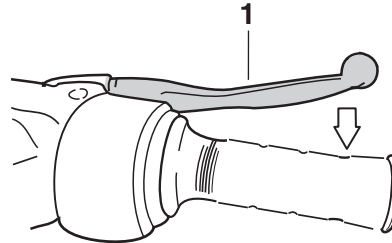

ZAJUM0791

### 1. Front brake lever

The front brake lever is located on the right side of the handlebar. To apply the front brake, pull this lever toward the throttle grip.

EAU12901

## Rear brake lever

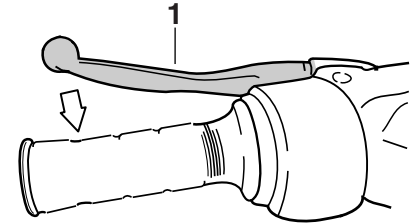

ZAJUM0085

### 1. Rear brake lever

The rear brake lever is located on the left side of the handlebar. To apply the rear brake, pull this lever toward the handlebar grip.

# INSTRUMENT AND CONTROL FUNCTIONS

## Fuel and 2-stroke engine oil tank caps

EAU13202

The fuel tank cap and the 2-stroke engine oil tank cap are located under the seat. (See page 3-8.)

### Fuel tank cap

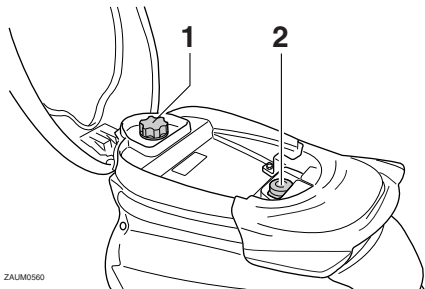

ZAUM0560

1. Fuel tank cap
2. 2-stroke engine oil tank cap

To remove the fuel tank cap, turn it counterclockwise, and then pull it off.  
To install the fuel tank cap, turn it clockwise.

### 2-stroke engine oil tank cap

To remove the 2-stroke engine oil tank cap, pull it off.

To install the 2-stroke engine oil tank cap, push it into the oil tank opening.

EWA10141



**WARNING**

**Make sure that the fuel and 2-stroke engine oil tank caps are properly installed before riding the scooter. Leaking fuel is a fire hazard.**

## Fuel

EAU13212

Make sure there is sufficient gasoline in the tank.

EWA10881



**Gasoline and gasoline vapors are extremely flammable. To avoid fires and explosions and to reduce the risk of injury when refueling, follow these instructions.**

1. Before refueling, turn off the engine and be sure that no one is sitting on the vehicle. Never refuel while smoking, or while in the vicinity of sparks, open flames, or other sources of ignition such as the pilot lights of water heaters and clothes dryers.
2. Do not overfill the fuel tank. Stop filling when the fuel reaches the bottom of the filler tube. Because fuel expands when it heats up, heat from the engine or the sun can cause fuel to spill out of the fuel tank.

# INSTRUMENT AND CONTROL FUNCTIONS

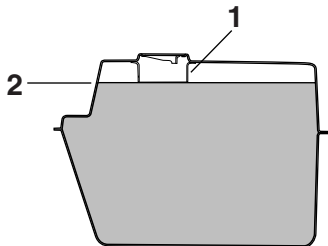

ZAJUM0020

1. Fuel tank filler tube
2. Maximum fuel level
3. Wipe up any spilled fuel immediately. **NOTICE: Immediately wipe off spilled fuel with a clean, dry, soft cloth, since fuel may deteriorate painted surfaces or plastic parts.** [ECA10071]
4. Be sure to securely close the fuel tank cap.

EWA15151

## WARNING

Gasoline is poisonous and can cause injury or death. Handle gasoline with care. Never siphon gasoline by mouth. If you should swallow some gasoline or inhale a lot of gasoline vapor, or get some gasoline in your eyes, see your doctor immedi-

ately. If gasoline spills on your skin, wash with soap and water. If gasoline spills on your clothing, change your clothes.

EAM2730

### Recommended fuel:

Premium unleaded gasoline only

### Fuel tank capacity:

5.3 L (1.40 US gal, 1.17 Imp.gal)

### Fuel reserve amount (when the fuel level warning light comes on):

0.7 L (0.18 US gal, 0.15 Imp.gal)

Your Yamaha engine has been designed to use premium unleaded gasoline with a research octane number of 95 or higher. If knocking (or pinging) occurs, use a gasoline of a different brand. Use of unleaded fuel will extend spark plug life and reduce maintenance costs.

EAU13433

## Catalytic converter

This model is equipped with a catalytic converter in the exhaust system.

EWA10862

## WARNING

The exhaust system is hot after operation. To prevent a fire hazard or burns:

- Do not park the vehicle near possible fire hazards such as grass or other materials that easily burn.
- Park the vehicle in a place where pedestrians or children are not likely to touch the hot exhaust system.
- Make sure that the exhaust system has cooled down before doing any maintenance work.
- Do not allow the engine to idle more than a few minutes. Long idling can cause a build-up of heat.

# INSTRUMENT AND CONTROL FUNCTIONS

ECA10701

## NOTICE

Use only unleaded gasoline. The use of leaded gasoline will cause unreparable damage to the catalytic converter.

3

## 2-stroke engine oil

Make sure that there is sufficient 2-stroke engine oil in the oil tank. Add the recommended 2-stroke engine oil as necessary.

### Recommended oil:

See page 8-1.

### Oil quantity:

1.10 L (1.16 US qt, 0.97 Imp.qt)

EAU13453

ECA16670

## NOTICE

Make sure that the 2-stroke engine oil tank cap is properly installed.

EAUS1050

## Kickstarter

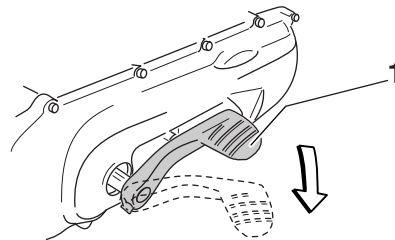

ZAJM0146

### 1. Kickstarter

To start the engine, push the kickstarter down lightly with your foot until the gears engage, and then push it down smoothly but forcefully.

## Securing bracket

EAUT1040

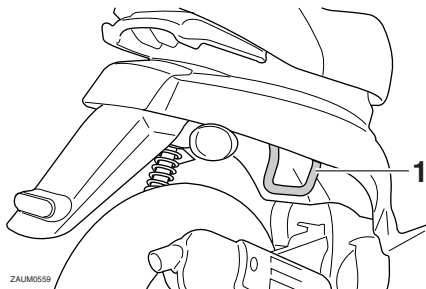

1. Securing bracket

To prevent theft, the securing bracket can be used to chain the scooter to a stationary object such as a lamppost or a fence.

To secure the scooter with a chain or cable lock, place the scooter on the centerstand, pass the chain or cable through the securing bracket and around the stationary object, and then lock the chain or cable lock.

EWAT1020



### WARNING

**Be sure to remove the chain or cable before riding, otherwise the scooter may overturn, causing damage or injury.**

## Seat

EAU13932

### To open the seat

1. Place the scooter on the centerstand.
2. Insert the key into the main switch, and then turn it counterclockwise to "OPEN".

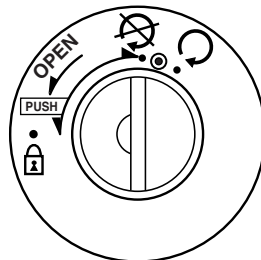

ZALIM0253

**TIP** \_\_\_\_\_  
Do not push inward when turning the key.

3. Fold the seat up.

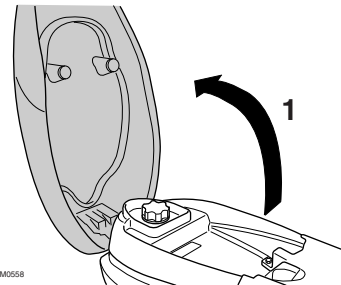

ZALIM0658

1. Open.

### To close the seat

1. Fold the seat down, and then push it down to lock it in place.
2. Remove the key from the main switch if the scooter will be left unattended.

**TIP** \_\_\_\_\_  
Make sure that the seat is properly secured before riding.

# INSTRUMENT AND CONTROL FUNCTIONS

## Anti-theft device housing

EAUM1580

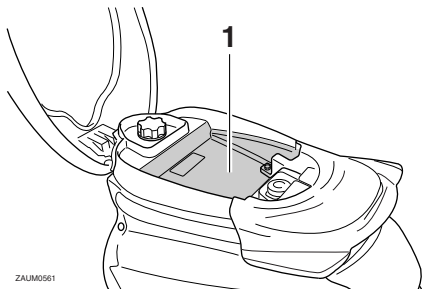

3

### 1. Anti-theft device housing

The anti-theft device housing, located under the seat, is designed to store a joint type anti-theft device with a maximum length of 1 meter. (See page 3-8 for seat opening and closing procedures.)

### TIP

Some anti-theft devices cannot fit into the housing due to their size or shape.

## Luggage hook

EAUT1072

EWAT1031

### ⚠ WARNING

- Do not exceed the load limit of 3 kg (6.6 lb) for the luggage hook.
- Do not exceed the maximum load of 185 kg (408 lb) for the vehicle.

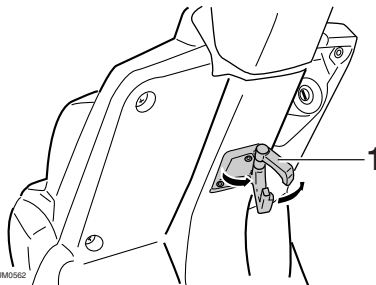

### 1. Luggage hook



# FOR YOUR SAFETY – PRE-OPERATION CHECKS

EAU15597

Inspect your vehicle each time you use it to make sure the vehicle is in safe operating condition. Always follow the inspection and maintenance procedures and schedules described in the Owner's Manual.

EWA11151

## **WARNING**

**Failure to inspect or maintain the vehicle properly increases the possibility of an accident or equipment damage. Do not operate the vehicle if you find any problem. If a problem cannot be corrected by the procedures provided in this manual, have the vehicle inspected by a Yamaha dealer.**

Before using this vehicle, check the following points:

ITEM	CHECKS	PAGE
Fuel	<ul style="list-style-type: none"><li>• Check fuel level in fuel tank.</li><li>• Refuel if necessary.</li><li>• Check fuel line for leakage.</li></ul>	3-5
2-stroke engine oil	<ul style="list-style-type: none"><li>• Check oil level in oil tank.</li><li>• If necessary, add recommended oil to specified level.</li><li>• Check vehicle for oil leakage.</li></ul>	3-7
Final transmission oil	<ul style="list-style-type: none"><li>• Check vehicle for oil leakage.</li></ul>	6-8
Front brake	<ul style="list-style-type: none"><li>• Check operation.</li><li>• Lubricate cable if necessary.</li><li>• Check lever free play.</li><li>• Adjust if necessary.</li></ul>	6-14
Rear brake	<ul style="list-style-type: none"><li>• Check operation.</li><li>• Lubricate cable if necessary.</li><li>• Check lever free play.</li><li>• Adjust if necessary.</li></ul>	6-14
Throttle grip	<ul style="list-style-type: none"><li>• Make sure that operation is smooth.</li><li>• Check throttle grip free play.</li><li>• If necessary, have Yamaha dealer adjust throttle grip free play and lubricate cable and grip housing.</li></ul>	6-10, 6-15

# FOR YOUR SAFETY – PRE-OPERATION CHECKS

ITEM	CHECKS	PAGE
<b>Wheels and tires</b>	<ul style="list-style-type: none"><li>• Check for damage.</li><li>• Check tire condition and tread depth.</li><li>• Check air pressure.</li><li>• Correct if necessary.</li></ul>	6-10, 6-12
<b>Brake levers</b>	<ul style="list-style-type: none"><li>• Make sure that operation is smooth.</li><li>• Lubricate lever pivoting points if necessary.</li></ul>	6-15
<b>Centerstand</b>	<ul style="list-style-type: none"><li>• Make sure that operation is smooth.</li><li>• Lubricate pivot if necessary.</li></ul>	6-15
<b>Chassis fasteners</b>	<ul style="list-style-type: none"><li>• Make sure that all nuts, bolts and screws are properly tightened.</li><li>• Tighten if necessary.</li></ul>	—
<b>Instruments, lights, signals and switches</b>	<ul style="list-style-type: none"><li>• Check operation.</li><li>• Correct if necessary.</li></ul>	—
<b>Battery</b>	<ul style="list-style-type: none"><li>• Check fluid level.</li><li>• Fill with distilled water if necessary.</li></ul>	6-17

# OPERATION AND IMPORTANT RIDING POINTS

EAU15951

Read the Owner's Manual carefully to become familiar with all controls. If there is a control or function you do not understand, ask your Yamaha dealer.

EWA10271

## WARNING

**Failure to familiarize yourself with the controls can lead to loss of control, which could cause an accident or injury.**



EAUM2940

## Starting a cold engine

ECA10250

### NOTICE

**See page 5-3 for engine break-in instructions prior to operating the vehicle for the first time.**

1. Turn the key to “”, and when the oil level warning light comes on, turn the key to “”.

ECA10240

### NOTICE

**If the oil level warning light does not come on, have a Yamaha dealer check the electrical circuit.**

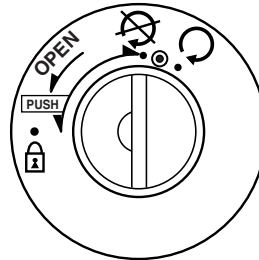

ZAUM0253

2. Close the throttle completely.

3. While applying the front or rear brake, start the engine by pushing the kickstarter lever down.

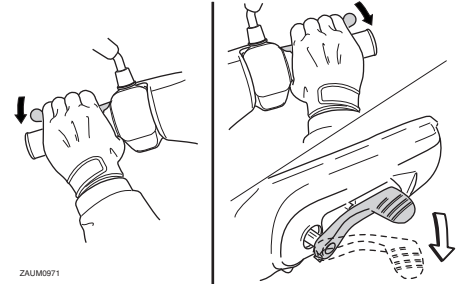

ZAUM0971

ECA11042

### NOTICE

**For maximum engine life, never accelerate hard when the engine is cold!**

# OPERATION AND IMPORTANT RIDING POINTS

## Starting off

EAU16761

### TIP

Before starting off, allow the engine to warm up.

1. While pulling the rear brake lever with your left hand and holding the grab bar with your right hand, push the scooter off the centerstand.

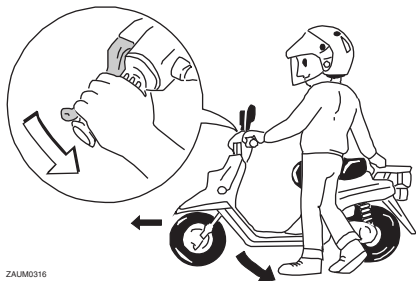

ZALM0316

2. Sit astride the seat, and then adjust the rear view mirrors.
3. Switch the turn signals on.
4. Check for oncoming traffic, and then slowly turn the throttle grip (on the right) in order to take off.
5. Switch the turn signals off.

## Acceleration and deceleration

EAU16780

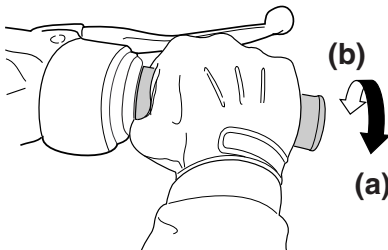

ZALM0199

The speed can be adjusted by opening and closing the throttle. To increase the speed, turn the throttle grip in direction (a). To reduce the speed, turn the throttle grip in direction (b).

## Braking

EAU16793

EWA10300

### ⚠ WARNING

- Avoid braking hard or suddenly (especially when leaning over to one side), otherwise the scooter may skid or overturn.
  - Railroad crossings, streetcar rails, iron plates on road construction sites, and manhole covers become extremely slippery when wet. Therefore, slow down when approaching such areas and cross them with caution.
  - Keep in mind that braking on a wet road is much more difficult.
  - Ride slowly down a hill, as braking downhill can be very difficult.
1. Close the throttle completely.
  2. Apply both front and rear brakes simultaneously while gradually increasing the pressure.

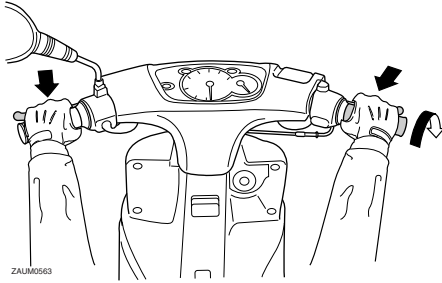

EAU16820

## Tips for reducing fuel consumption

Fuel consumption depends largely on your riding style. Consider the following tips to reduce fuel consumption:

- Avoid high engine speeds during acceleration.
- Avoid high engine speeds with no load on the engine.
- Turn the engine off instead of letting it idle for an extended length of time (e.g., in traffic jams, at traffic lights or at railroad crossings).

EAU16830

## Engine break-in

There is never a more important period in the life of your engine than the period between 0 and 1000 km (600 mi). For this reason, you should read the following material carefully.

Since the engine is brand new, do not put an excessive load on it for the first 1000 km (600 mi). The various parts in the engine wear and polish themselves to the correct operating clearances. During this period, prolonged full-throttle operation or any condition that might result in engine overheating must be avoided.

EAUM2091

### 0–150 km (0–90 mi)

Avoid prolonged operation above 1/3 throttle. Vary the speed of the scooter from time to time. Do not operate it at one set throttle position.

### 150–500 km (90–300 mi)

Avoid prolonged operation above 1/2 throttle.

### 500–1000 km (300–600 mi)

Avoid cruising speeds in excess of 3/4 throttle.

# OPERATION AND IMPORTANT RIDING POINTS

---

## 1000 km (600 mi) and beyond

Avoid prolonged full throttle operation. Vary speeds occasionally. **NOTICE:** After 1000 km (600 mi) of operation, the final transmission oil must be changed. [ECAM1071]

ECA10270

### NOTICE

If any engine trouble should occur during the engine break-in period, immediately have a Yamaha dealer check the vehicle.

---

EAU17213

## Parking

When parking, stop the engine, and then remove the key from the main switch.

EWA10311

### WARNING

- Since the engine and exhaust system can become very hot, park in a place where pedestrians or children are not likely to touch them and be burned.
  - Do not park on a slope or on soft ground, otherwise the vehicle may overturn, increasing the risk of a fuel leak and fire.
  - Do not park near grass or other flammable materials which might catch fire.
-

# PERIODIC MAINTENANCE AND ADJUSTMENT

EAU17244

Periodic inspection, adjustment, and lubrication will keep your vehicle in the safest and most efficient condition possible. Safety is an obligation of the vehicle owner/operator. The most important points of vehicle inspection, adjustment, and lubrication are explained on the following pages.

The intervals given in the periodic maintenance charts should be simply considered as a general guide under normal riding conditions. However, depending on the weather, terrain, geographical location, and individual use, the maintenance intervals may need to be shortened.

EWA10321

## WARNING

**Failure to properly maintain the vehicle or performing maintenance activities incorrectly may increase your risk of injury or death during service or while using the vehicle. If you are not familiar with vehicle service, have a Yamaha dealer perform service.**

EWA15122

## WARNING

**Turn off the engine when performing maintenance unless otherwise specified.**

- **A running engine has moving parts that can catch on body parts or clothing and electrical parts that can cause shocks or fires.**
- **Running the engine while servicing can lead to eye injury, burns, fire, or carbon monoxide poisoning – possibly leading to death. See page 1-3 for more information about carbon monoxide.**

EWA15460

## WARNING

**Brake discs, calipers, drums, and linings can become very hot during use. To avoid possible burns, let brake components cool before touching them.**

EAU17302

Emission controls not only function to ensure cleaner air, but are also vital to proper engine operation and maximum performance. In the following periodic maintenance charts, the services related to emissions control are grouped separately. These services require specialized data, knowledge, and equipment. Maintenance, replacement, or repair of the emission control devices and systems may be performed by any repair establishment or individual that is certified (if applicable). Yamaha dealers are trained and equipped to perform these particular services.

# PERIODIC MAINTENANCE AND ADJUSTMENT

EAU46871

## TIP

- **The annual checks must be performed every year, except if a kilometer-based maintenance, or for the UK, a mileage-based maintenance, is performed instead.**
- From 30000 km (17500 mi), repeat the maintenance intervals starting from 6000 km (3500 mi).
- Items marked with an asterisk should be performed by a Yamaha dealer as they require special tools, data and technical skills.

EAU46920

## Periodic maintenance chart for the emission control system

NO.	ITEM	CHECK OR MAINTENANCE JOB	ODOMETER READING					ANNUAL CHECK
			1000 km (600 mi)	6000 km (3500 mi)	12000 km (7000 mi)	18000 km (10500 mi)	24000 km (14000 mi)	
1	* Fuel line	• Check fuel and vacuum hoses for cracks or damage.		√	√	√	√	√
2	Spark plug	• Replace.		√	√	√	√	√
3	* Carburetor	• Adjust engine idling speed.	√	√	√	√	√	√

6



# PERIODIC MAINTENANCE AND ADJUSTMENT

EAU17718

## General maintenance and lubrication chart

NO.	ITEM	CHECK OR MAINTENANCE JOB	ODOMETER READING					ANNUAL CHECK
			1000 km (600 mi)	6000 km (3500 mi)	12000 km (7000 mi)	18000 km (10500 mi)	24000 km (14000 mi)	
1	Air filter element	• Clean.		√		√		
		• Replace.			√		√	
2	* Battery	<ul style="list-style-type: none"> <li>• Check electrolyte level and specific gravity.</li> <li>• Make sure that the breather hose is properly routed.</li> </ul>		√	√	√	√	√
3	* Front brake	• Check operation and adjust brake lever free play.	√	√	√	√	√	√
		• Replace brake shoes.	Whenever worn to the limit					
4	* Rear brake	• Check operation and adjust brake lever free play.	√	√	√	√	√	√
		• Replace brake shoes.	Whenever worn to the limit					
5	* Wheels	• Check runout and for damage.		√	√	√	√	
6	* Tires	<ul style="list-style-type: none"> <li>• Check tread depth and for damage.</li> <li>• Replace if necessary.</li> <li>• Check air pressure.</li> <li>• Correct if necessary.</li> </ul>		√	√	√	√	√
7	* Wheel bearings	• Check bearing for looseness or damage.		√	√	√	√	
8	* Steering bearings	• Check bearing play and steering for roughness.	√	√	√	√	√	
		• Lubricate with lithium-soap-based grease.	Every 24000 km (14000 mi)					

# PERIODIC MAINTENANCE AND ADJUSTMENT

NO.	ITEM	CHECK OR MAINTENANCE JOB	ODOMETER READING					ANNUAL CHECK
			1000 km (600 mi)	6000 km (3500 mi)	12000 km (7000 mi)	18000 km (10500 mi)	24000 km (14000 mi)	
9	* Chassis fasteners	• Make sure that all nuts, bolts and screws are properly tightened.		√	√	√	√	√
10	Front brake lever pivot shaft	• Lubricate with lithium-soap-based grease.		√	√	√	√	√
11	Rear brake lever pivot shaft	• Lubricate with lithium-soap-based grease.		√	√	√	√	√
12	Centerstand	• Check operation. • Lubricate.		√	√	√	√	√
13	* Front fork	• Check operation and for oil leakage.		√	√	√	√	
14	* Shock absorber assembly	• Check operation and shock absorber for oil leakage.		√	√	√	√	
15	* Autolube pump	• Check operation. • Bleed if necessary.	√		√		√	√
16	Final transmission oil	• Check vehicle for oil leakage.	√	√		√		
		• Change.	√		√		√	
17	* V-belt	• Replace.	Every 10000 km (6000 mi)					
18	* Front and rear brake switches	• Check operation.	√	√	√	√	√	√
19	Moving parts and cables	• Lubricate.		√	√	√	√	√
20	* Throttle grip	• Check operation. • Check throttle grip free play, and adjust if necessary. • Lubricate cable and grip housing.		√	√	√	√	√

# PERIODIC MAINTENANCE AND ADJUSTMENT

NO.	ITEM	CHECK OR MAINTENANCE JOB	ODOMETER READING					ANNUAL CHECK
			1000 km (600 mi)	6000 km (3500 mi)	12000 km (7000 mi)	18000 km (10500 mi)	24000 km (14000 mi)	
21	* Lights, signals and switches	<ul style="list-style-type: none"> <li>• Check operation.</li> <li>• Adjust headlight beam.</li> </ul>	√	√	√	√	√	√

EAU18690

## TIP

The air filter needs more frequent service if you are riding in unusually wet or dusty areas.

# PERIODIC MAINTENANCE AND ADJUSTMENT

## Removing and installing the cowling and panels

EAU18722

The cowling and panels shown need to be removed to perform some of the maintenance jobs described in this chapter. Refer to this section each time the cowling or a panel needs to be removed and installed.

### Cowling A

EAU18790

#### To remove the cowling

Remove the screws, and then take the cowling off.

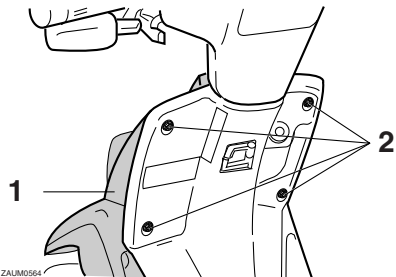

1. Cowling A
2. Screw

#### To install the cowling

Place the cowling in the original position, and then install the screws.

### Panel A

EAU19272

#### To remove the panel

Remove the screw, and then pull outward on the areas shown.

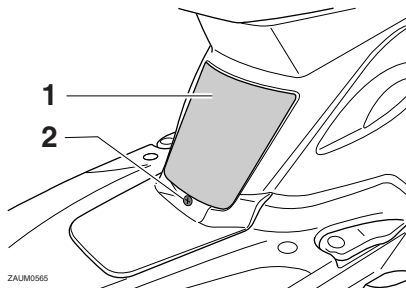

1. Panel A
2. Screw

#### To install the panel

Place the panel in the original position, and then install the screw.

### Panel B

EAU19210

#### To remove the panel

Remove the screws, and then take the panel off.

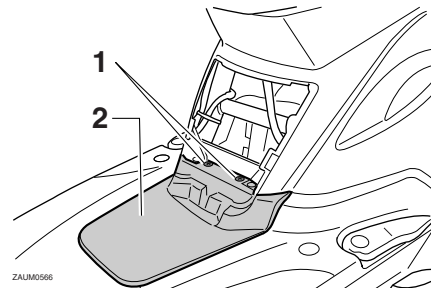

1. Screw
2. Panel B

#### To install the panel

Place the panel in the original position, and then install the screws.

# PERIODIC MAINTENANCE AND ADJUSTMENT

## Checking the spark plug

EAU19622

The spark plug is an important engine component, which should be checked periodically, preferably by a Yamaha dealer. Since heat and deposits will cause any spark plug to slowly erode, it should be removed and checked in accordance with the periodic maintenance and lubrication chart. In addition, the condition of the spark plug can reveal the condition of the engine.

The porcelain insulator around the center electrode of the spark plug should be a medium-to-light tan (the ideal color when the vehicle is ridden normally). If the spark plug shows a distinctly different color, the engine could be operating improperly. Do not attempt to diagnose such problems yourself. Instead, have a Yamaha dealer check the vehicle. If the spark plug shows signs of electrode erosion and excessive carbon or other deposits, it should be replaced.

**Specified spark plug:**  
NGK/BR8HS

Before installing a spark plug, the spark plug gap should be measured with a wire thickness gauge and, if necessary, adjusted to specification.

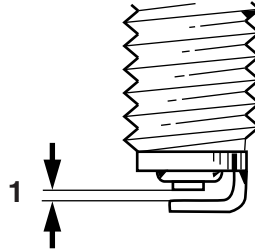

ZAUM0037

1. Spark plug gap

**Spark plug gap:**  
0.6–0.7 mm (0.024–0.028 in)

Clean the surface of the spark plug gasket and its mating surface, and then wipe off any grime from the spark plug threads.

**Tightening torque:**  
Spark plug:  
20 Nm (2.0 m·kgf, 14 ft·lbf)

## TIP

If a torque wrench is not available when installing a spark plug, a good estimate of the correct torque is 1/4–1/2 turn past finger tight. However, the spark plug should be tightened to the specified torque as soon as possible.

# PERIODIC MAINTENANCE AND ADJUSTMENT

EAU20066

## Final transmission oil

The final transmission case must be checked for oil leakage before each ride. If any leakage is found, have a Yamaha dealer check and repair the scooter. In addition, the final transmission oil must be changed as follows at the intervals specified in the periodic maintenance and lubrication chart.

1. Start the engine, warm up the final transmission oil by riding the scooter for several minutes, and then stop the engine.
2. Place the scooter on the center-stand.
3. Place an oil pan under the final transmission case to collect the used oil.
4. Remove the final transmission oil filler cap and its O-ring from the final transmission case.

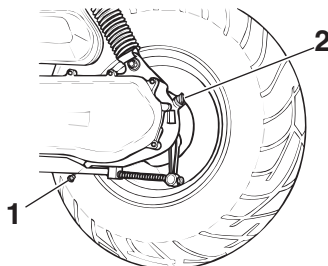

ZAJM0984

1. Final transmission oil drain bolt
2. Final transmission oil filler cap
5. Remove the final transmission oil drain bolt and its gasket to drain the oil from the final transmission case.
6. Install the final transmission oil drain bolt and its new gasket, and then tighten the bolt to the specified torque.

### Tightening torque:

Final transmission oil drain bolt:  
17 Nm (1.7 m·kgf, 12 ft·lbf)

7. Refill with the specified amount of the recommended final transmission oil. **WARNING! Make sure that no foreign material enters**

the final transmission case. **Make sure that no oil gets on the tire or wheel.** [EWA11311]

### Recommended final transmission oil:

See page 8-1.

### Oil quantity:

0.11 L (0.12 US qt, 0.10 Imp.qt)

8. Install the final transmission oil filler cap and its new O-ring, and then tighten the oil filler cap.
9. Check the final transmission case for oil leakage. If oil is leaking, check for the cause.

# PERIODIC MAINTENANCE AND ADJUSTMENT

## Cleaning the air filter element EAM1642

The air filter element should be cleaned at the intervals specified in the periodic maintenance and lubrication chart. Clean the air filter element more frequently if you are riding in unusually wet or dusty areas.

1. Remove the air filter case cover by removing the screws.

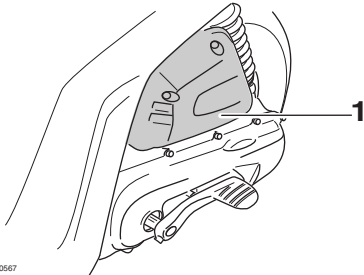

1. Air filter case cover

2. Pull the air filter element out, clean it with solvent, and then squeeze the remaining solvent out. **WARNING! Use only a dedicated parts cleaning solvent. To avoid the risk of fire or explosion, do not use gasoline or solvents with a low flash point.**

[EWA10431] **NOTICE:** To avoid damaging the foam material, handle it gently and carefully, and do not twist or wring it. [ECA10511]

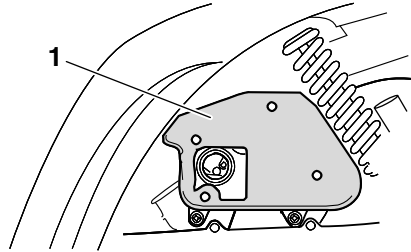

1. Air filter element

3. Apply oil of the recommended type to the entire surface of the element, and then squeeze the excess oil out.

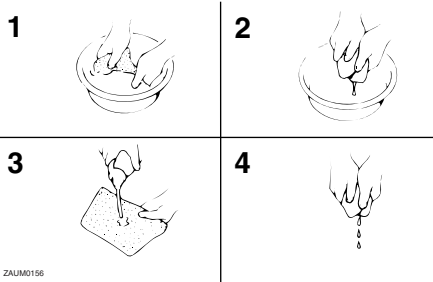

## TIP

The air filter element should be wet but not dripping.

**Recommended oil:**  
Foam air filter oil

4. Insert the element into the air filter case. **NOTICE:** Make sure that the air filter element is properly seated in the air filter case. The engine should never be operated without the air filter element installed, otherwise the piston(s) and/or cylinder(s) may become excessively worn.
5. Install the air filter case cover by installing the screws.

[ECA10481]

# PERIODIC MAINTENANCE AND ADJUSTMENT

## Adjusting the carburetor

EAU21300

The carburetor is an important part of the engine and requires very sophisticated adjustment. Therefore, all carburetor adjustments should be left to a Yamaha dealer, who has the necessary professional knowledge and experience.

## Checking the throttle grip free play

EAU21384

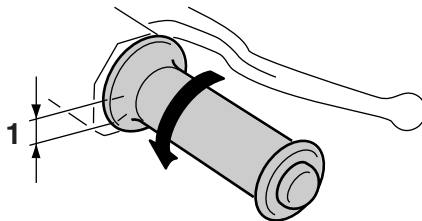

ZALIM0051

### 1. Throttle grip free play

The throttle grip free play should measure 1.5–3.0 mm (0.06–0.12 in) at the inner edge of the throttle grip. Periodically check the throttle grip free play and, if necessary, have a Yamaha dealer adjust it.

## Tires

EAU21876

Tires are the only contact between the vehicle and the road. Safety in all conditions of riding depends on a relatively small area of road contact. Therefore, it is essential to maintain the tires in good condition at all times and replace them at the appropriate time with the specified tires.

## Tire air pressure

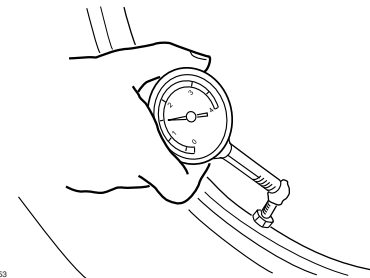

ZALIM0053

The tire air pressure should be checked and, if necessary, adjusted before each ride.



# PERIODIC MAINTENANCE AND ADJUSTMENT

EWA10503

## WARNING

Operation of this vehicle with improper tire pressure may cause severe injury or death from loss of control.

- The tire air pressure must be checked and adjusted on cold tires (i.e., when the temperature of the tires equals the ambient temperature).
- The tire air pressure must be adjusted in accordance with the riding speed and with the total weight of rider, passenger, cargo, and accessories approved for this model.

### Tire air pressure (measured on cold tires):

#### 0–90 kg (0–198 lb):

Front:  
150 kPa (1.50 kgf/cm<sup>2</sup>, 22 psi)

Rear:  
150 kPa (1.50 kgf/cm<sup>2</sup>, 22 psi)

#### 90–185 kg (198–408 lb):

Front:  
150 kPa (1.50 kgf/cm<sup>2</sup>, 22 psi)

Rear:  
150 kPa (1.50 kgf/cm<sup>2</sup>, 22 psi)

#### Maximum load\*:

185 kg (408 lb)

\* Total weight of rider, passenger, cargo and accessories

EWA10511

## WARNING

Never overload your vehicle. Operation of an overloaded vehicle could cause an accident.

## Tire inspection

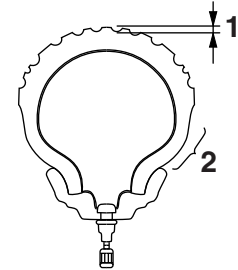

ZALUM0054

1. Tire tread depth
2. Tire sidewall

The tires must be checked before each ride. If the center tread depth reaches the specified limit, if the tire has a nail or glass fragments in it, or if the sidewall is cracked, have a Yamaha dealer replace the tire immediately.

### Minimum tire tread depth (front and rear):

1.6 mm (0.06 in)

## TIP

The tire tread depth limits may differ from country to country. Always comply with the local regulations.

# PERIODIC MAINTENANCE AND ADJUSTMENT

EAUM2950

## Tire information

This model is equipped with tubeless tires.

Tires age, even if they have not been used or have only been used occasionally. Cracking of the tread and sidewall rubber, sometimes accompanied by carcass deformation, is an evidence of ageing. Old and aged tires shall be checked by tire specialists to ascertain their suitability for further use.

After extensive tests, only the tires listed below have been approved for this model by Yamaha Motor Co., Ltd.

**cle with excessively worn tires decreases riding stability and can lead to loss of control.**

- **The replacement of all wheel and brake-related parts, including the tires, should be left to a Yamaha dealer, who has the necessary professional knowledge and experience to do so.**
- **Ride at moderate speeds after changing a tire since the tire surface must first be “broken in” for it to develop its optimal characteristics.**

## Panel wheels

To maximize the performance, durability, and safe operation of your vehicle, note the following points regarding the specified wheels.

- The wheel rims should be checked for cracks, bends, warpage or damage before each ride. If any damage is found, have a Yamaha dealer replace the wheel. Do not attempt even the smallest repair to the wheel. A deformed or cracked wheel must be replaced.
- The wheel should be balanced whenever either the tire or wheel has been changed or replaced. An unbalanced wheel can result in poor performance, adverse handling characteristics, and a shortened tire life.

6

### Front tire:

Size:

120/90-10 56J

Manufacturer/model:

SAVA / MC17

### Rear tire:

Size:

130/90-10 61J

Manufacturer/model:

SAVA / MC17

EWA10471



**WARNING**

- **Have a Yamaha dealer replace excessively worn tires. Besides being illegal, operating the vehi-**

# PERIODIC MAINTENANCE AND ADJUSTMENT

EAU22152

## Adjusting the front and rear brake lever free play

The front and rear brake lever free play should be measured at the positions as shown.

### Front

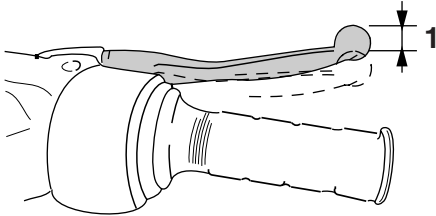

ZAJUM0107

1. Front brake lever free play

### Rear

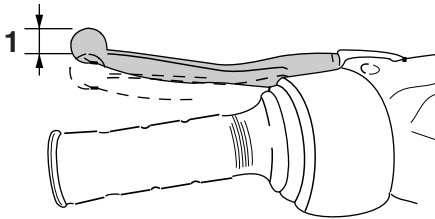

ZAJUM0108

1. Rear brake lever free play

**Front brake lever free play:**  
5.0–10.0 mm (0.20–0.39 in)  
**Rear brake lever free play:**  
5.0–10.0 mm (0.20–0.39 in)

Periodically check the front and rear brake lever free play and, if necessary, adjust them as follows.

To increase the brake lever free play, turn the adjusting nut at the brake shoe plate in direction (a). To decrease the brake lever free play, turn the adjusting nut in direction (b).

### Front

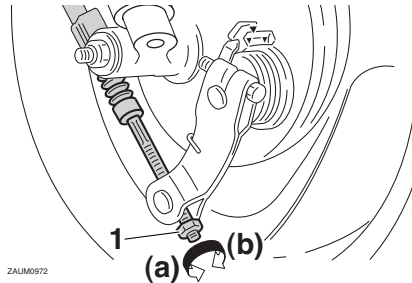

ZAJUM0972

1. Brake lever free play adjusting nut

### Rear

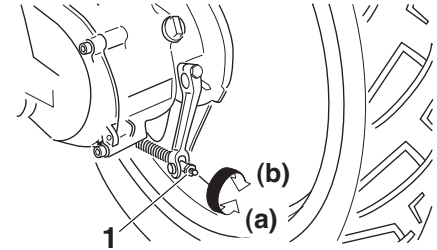

ZAJUM0998

1. Brake lever free play adjusting nut

EWA10650

## **! WARNING**

If proper adjustment cannot be obtained as described, have a Yamaha dealer make this adjustment.

# PERIODIC MAINTENANCE AND ADJUSTMENT

## Checking the front and rear brake shoes

EAU22361

### Front

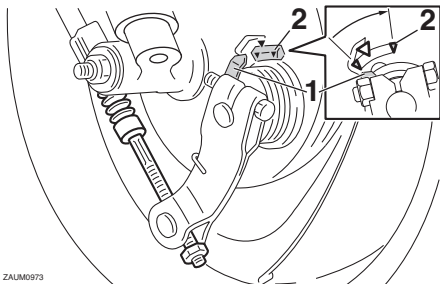

1. Wear indicator
2. Wear limit line

### Rear

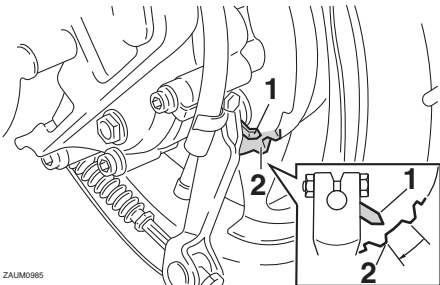

1. Wear indicator
2. Wear limit line

The front and rear brake shoes must be checked for wear at the intervals specified in the periodic maintenance and lubrication chart. Each brake is provided with a wear indicator, which allows you to check the brake shoe wear without having to disassemble the brake. To check the brake shoe wear, check the position of the wear indicator while applying the brake. If a brake shoe has worn to the point that the wear indicator reaches the wear limit line, have a Yamaha dealer replace the brake shoes as a set.

## Checking and lubricating the cables

EAU50800

The operation of all control cables and the condition of the cables should be checked before each ride, and the cables and cable ends should be lubricated if necessary. If a cable is damaged or does not move smoothly, have a Yamaha dealer check or replace it. **WARNING! Damage to the outer housing of cables may result in internal rusting and cause interference with cable movement. Replace damaged cables as soon as possible to prevent unsafe conditions.**

[EWA10711]

### Recommended lubricant:

Yamaha Chain and Cable Lube or 4-stroke engine oil

# PERIODIC MAINTENANCE AND ADJUSTMENT

## Checking and lubricating the throttle grip and cable

EAU49920

The operation of the throttle grip should be checked before each ride. In addition, the cable should be lubricated by a Yamaha dealer at the intervals specified in the periodic maintenance chart.

## Lubricating the front and rear brake levers

EAU43631

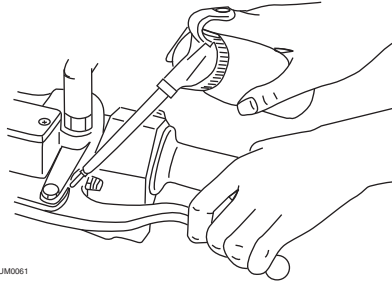

ZALM0061

The pivoting points of the front and rear brake levers must be lubricated at the intervals specified in the periodic maintenance and lubrication chart.

**Recommended lubricant:**  
Lithium-soap-based grease

## Checking and lubricating the centerstand

EAU23192

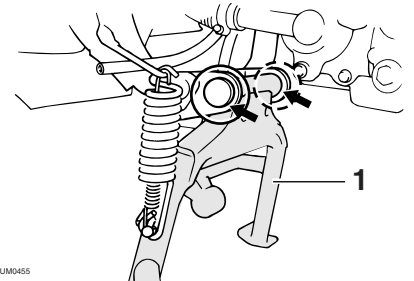

ZALM0455

1. Centerstand

The operation of the centerstand should be checked before each ride, and the pivots and metal-to-metal contact surfaces should be lubricated if necessary.

### **⚠ WARNING**

**If the centerstand does not move up and down smoothly, have a Yamaha dealer check or repair it. Otherwise, the centerstand could contact the ground and distract the operator, resulting in a possible loss of control.**

EAU11301

# PERIODIC MAINTENANCE AND ADJUSTMENT

**Recommended lubricant:**  
Lithium-soap-based grease

EAU23272

## Checking the front fork

The condition and operation of the front fork must be checked as follows at the intervals specified in the periodic maintenance and lubrication chart.

### To check the condition

Check the inner tubes for scratches, damage and excessive oil leakage.

### To check the operation

1. Place the vehicle on a level surface and hold it in an upright position. **WARNING! To avoid injury, securely support the vehicle so there is no danger of it falling over.** [EWA10751]
2. While applying the front brake, push down hard on the handlebars several times to check if the front fork compresses and rebounds smoothly.

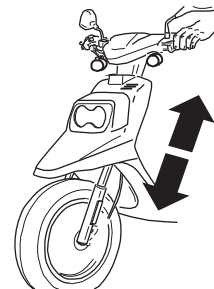

ZAJM0986

ECA10590

## **NOTICE**

**If any damage is found or the front fork does not operate smoothly, have a Yamaha dealer check or repair it.**

# PERIODIC MAINTENANCE AND ADJUSTMENT

## Checking the steering

EAU45511

Worn or loose steering bearings may cause danger. Therefore, the operation of the steering must be checked as follows at the intervals specified in the periodic maintenance and lubrication chart.

1. Place the vehicle on the centerstand. **WARNING! To avoid injury, securely support the vehicle so there is no danger of it falling over.** [EWA10751]
2. Hold the lower ends of the front fork legs and try to move them forward and backward. If any free play can be felt, have a Yamaha dealer check or repair the steering.

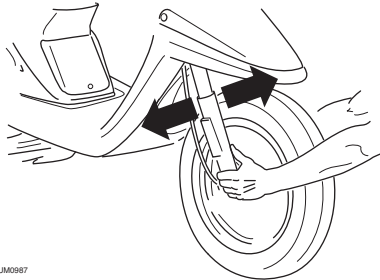

ZALU0987

## Checking the wheel bearings

EAU23291

The front and rear wheel bearings must be checked at the intervals specified in the periodic maintenance and lubrication chart. If there is play in the wheel hub or if the wheel does not turn smoothly, have a Yamaha dealer check the wheel bearings.

## Battery

EAUM1404

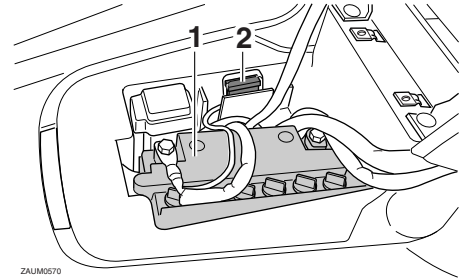

ZALU0570

1. Battery
2. Fuse

A poorly maintained battery will corrode and discharge quickly. The electrolyte level, battery lead connections and breather hose routing should be checked before each ride and at the intervals specified in the periodic maintenance and lubrication chart.

### To check the electrolyte level

1. Place the scooter on a level surface and hold it in an upright position.

# PERIODIC MAINTENANCE AND ADJUSTMENT

## TIP

Make sure that the scooter is positioned straight up when checking the electrolyte level.

2. Remove panel B. (See page 6-6.)
3. Check the electrolyte level in the battery.

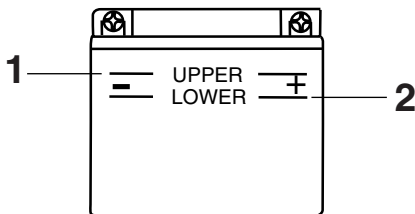

ZALUM0106

1. Maximum level mark
2. Minimum level mark

## TIP

The electrolyte should be between the minimum and maximum level marks.

4. If the electrolyte is at or below the minimum level mark, add distilled water to raise it to the maximum level mark. **NOTICE: Use only**

distilled water, as tap water contains minerals that are harmful to the battery. [ECA10611]

EWA10760

## WARNING

- **Electrolyte is poisonous and dangerous since it contains sulfuric acid, which causes severe burns. Avoid any contact with skin, eyes or clothing and always shield your eyes when working near batteries. In case of contact, administer the following FIRST AID.**

- **EXTERNAL:** Flush with plenty of water.
- **INTERNAL:** Drink large quantities of water or milk and immediately call a physician.
- **EYES:** Flush with water for 15 minutes and seek prompt medical attention.
- **Batteries produce explosive hydrogen gas. Therefore, keep sparks, flames, cigarettes, etc., away from the battery and provide sufficient ventilation when charging it in an enclosed space.**

- **KEEP THIS AND ALL BATTERIES OUT OF THE REACH OF CHILDREN.**

5. Check and, if necessary, tighten the battery lead connections and correct the breather hose routing.

## To store the battery

1. If the scooter will not be used for more than one month, remove the battery, fully charge it, and then place it in a cool, dry place. **NOTICE: When removing the battery, be sure the key is turned to “⊗”, then disconnect the negative lead before disconnecting the positive lead.** [ECA16302]
2. If the battery will be stored for more than two months, check the specific gravity of the electrolyte at least once a month and fully charge the battery whenever necessary.
3. Fully charge the battery before installation. **NOTICE: When installing the battery, be sure the key is turned to “⊗”, then connect the positive lead before connecting the negative lead.** [ECA16840]



# PERIODIC MAINTENANCE AND ADJUSTMENT

4. After installation, make sure that the battery leads are properly connected to the battery terminals and that the breather hose is properly routed, in good condition, and not obstructed. **NOTICE:** If the breather hose is positioned in such a way that the frame is exposed to electrolyte or gas expelled from the battery, the frame could suffer structural and external damages. [ECA10601]

## Replacing the fuse

EAU23503

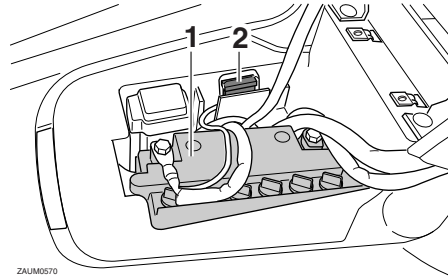

ZAUM0570

1. Battery
2. Fuse

The fuse holder is located behind panel B. (See page 6-6.)

If the fuse is blown, replace it as follows.

1. Turn the key to “ $\otimes$ ” and turn off all electrical circuits.
2. Remove the blown fuse, and then install a new fuse of the specified amperage. **WARNING!** Do not use a fuse of a higher amperage rating than recommended to avoid causing extensive damage to the electrical system and possibly a fire. [EWA15131]

**Specified fuse:**  
7.5 A

3. Turn the key to “ $\circ$ ” and turn on the electrical circuits to check if the devices operate.
4. If the fuse immediately blows again, have a Yamaha dealer check the electrical system.

# PERIODIC MAINTENANCE AND ADJUSTMENT

## Replacing a headlight bulb

EAM2930

If a headlight bulb burns out, replace it as follows.

1. Place the scooter on the center-stand.
2. Remove cowling A. (See page 6-6.)
3. Unhook the headlight bulb holder, and then remove the burnt out bulb.

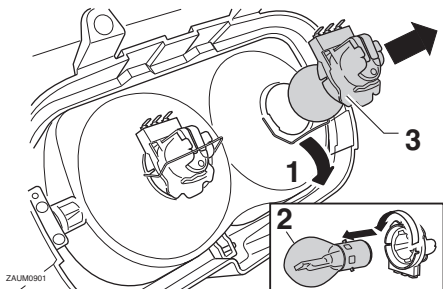

1. Unhook.
2. Headlight bulb
3. Headlight bulb holder

4. Place a new bulb into position, and then secure it with the bulb holder.
5. Install the cowling.
6. Have a Yamaha dealer adjust the headlight beam if necessary.

## Replacing the tail/brake light bulb

EAU24133

1. Remove the tail/brake light lens by removing the screws.

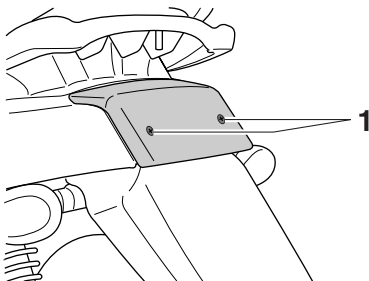

1. Screw

2. Remove the burnt-out bulb by pushing it in and turning it counter-clockwise.

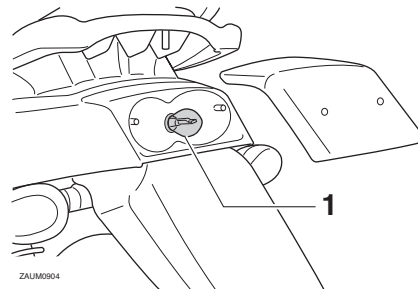

1. Tail/brake light bulb

3. Insert a new bulb into the socket, push it in, and then turn it clockwise until it stops.
4. Install the lens by installing the screws. **NOTICE: Do not over-tighten the screws, otherwise the lens may break.** [ECA10681]

## Replacing a turn signal light bulb

EAU24204

1. Remove the turn signal light lens by removing the screw.

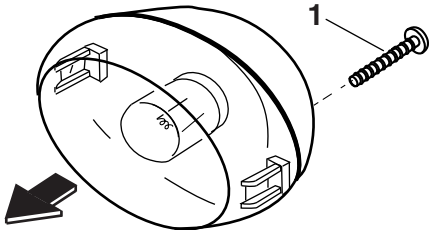

ZALUM0689

1. Screw
2. Remove the burnt-out bulb by pushing it in and turning it counter-clockwise.
3. Insert a new bulb into the socket, push it in, and then turn it clockwise until it stops.
4. Install the lens by installing the screw. **NOTICE: Do not over-tighten the screw, otherwise the lens may break.** [ECA11191]

## Troubleshooting

EAU25861

Although Yamaha scooters receive a thorough inspection before shipment from the factory, trouble may occur during operation. Any problem in the fuel, compression, or ignition systems, for example, can cause poor starting and loss of power.

The following troubleshooting chart represents a quick and easy procedure for checking these vital systems yourself. However, should your scooter require any repair, take it to a Yamaha dealer, whose skilled technicians have the necessary tools, experience, and know-how to service the scooter properly.

Use only genuine Yamaha replacement parts. Imitation parts may look like Yamaha parts, but they are often inferior, have a shorter service life and can lead to expensive repair bills.

EWA15141

### **WARNING**

**When checking the fuel system, do not smoke, and make sure there are no open flames or sparks in the area, including pilot lights from water**

**heaters or furnaces. Gasoline or gasoline vapors can ignite or explode, causing severe injury or property damage.**

# PERIODIC MAINTENANCE AND ADJUSTMENT

EAU25974

## Troubleshooting chart

### 1. Fuel

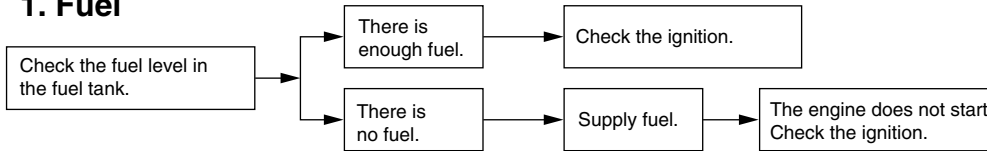

### 2. Ignition

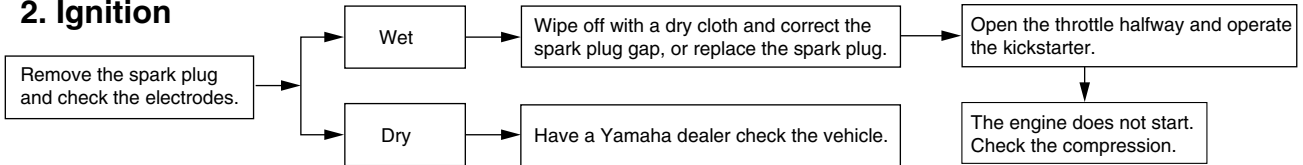

### 3. Compression

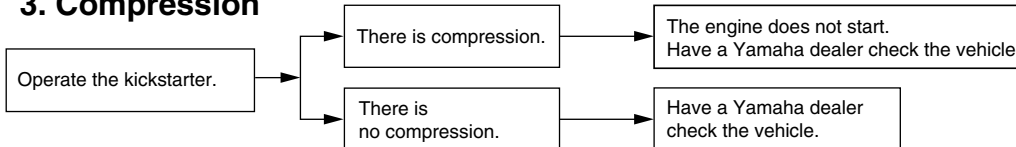

## Matte color caution

EAU37833

ECA15192

### NOTICE

**Some models are equipped with matte colored finished parts. Be sure to consult a Yamaha dealer for advice on what products to use before cleaning the vehicle. Using a brush, harsh chemical products or cleaning compounds when cleaning these parts will scratch or damage their surface. Wax also should not be applied to any matte colored finished parts.**

## Care

EAU26095

While the open design of a scooter reveals the attractiveness of the technology, it also makes it more vulnerable. Rust and corrosion can develop even if high-quality components are used. A rusty exhaust pipe may go unnoticed on a car, however, it detracts from the overall appearance of a scooter. Frequent and proper care does not only comply with the terms of the warranty, but it will also keep your scooter looking good, extend its life and optimize its performance.

### Before cleaning

1. Cover the muffler outlet with a plastic bag after the engine has cooled down.
2. Make sure that all caps and covers as well as all electrical couplers and connectors, including the spark plug cap, are tightly installed.
3. Remove extremely stubborn dirt, like oil burnt onto the crankcase, with a degreasing agent and a brush, but never apply such prod-

ucts onto seals, gaskets and wheel axles. Always rinse the dirt and degreaser off with water.

## Cleaning

ECA10783

### NOTICE

- **Avoid using strong acidic wheel cleaners, especially on spoked wheels. If such products are used on hard-to-remove dirt, do not leave the cleaner on the affected area any longer than instructed. Also, thoroughly rinse the area off with water, immediately dry it, and then apply a corrosion protection spray.**
- **Improper cleaning can damage plastic parts (such as cowlings, panels, windshields, headlight lenses, meter lenses, etc.) and the mufflers. Use only a soft, clean cloth or sponge with water to clean plastic. However, if the plastic parts cannot be thoroughly cleaned with water, diluted mild detergent with water may be used. Be sure to rinse**

# SCOOTER CARE AND STORAGE

---

off any detergent residue using plenty of water, as it is harmful to plastic parts.

- Do not use any harsh chemical products on plastic parts. Be sure to avoid using cloths or sponges which have been in contact with strong or abrasive cleaning products, solvent or thinner, fuel (gasoline), rust removers or inhibitors, brake fluid, antifreeze or electrolyte.
- Do not use high-pressure washers or steam-jet cleaners since they cause water seepage and deterioration in the following areas: seals (of wheel and swing-arm bearings, fork and brakes), electric components (couplers, connectors, instruments, switches and lights), breather hoses and vents.
- For scooters equipped with a windshield: Do not use strong cleaners or hard sponges as they will cause dulling or scratching. Some cleaning compounds for plastic may leave scratches on the windshield.

Test the product on a small hidden part of the windshield to make sure that it does not leave any marks. If the windshield is scratched, use a quality plastic polishing compound after washing.

---

## After normal use

Remove dirt with warm water, a mild detergent, and a soft, clean sponge, and then rinse thoroughly with clean water. Use a toothbrush or bottlebrush for hard-to-reach areas. Stubborn dirt and insects will come off more easily if the area is covered with a wet cloth for a few minutes before cleaning.

## After riding in the rain, near the sea or on salt-sprayed roads

Since sea salt or salt sprayed on the roads during winter are extremely corrosive in combination with water, carry out the following steps after each ride in the rain, near the sea or on salt-sprayed roads.

## TIP

Salt sprayed on roads in the winter may remain well into spring.

---

1. Clean the scooter with cold water and a mild detergent after the engine has cooled down. **NOTICE: Do not use warm water since it increases the corrosive action of the salt.** [ECA10791]
2. Apply a corrosion protection spray on all metal, including chrome- and nickel-plated, surfaces to prevent corrosion.

## Cleaning the windshield

Avoid using any alkaline or strong acid cleaner, gasoline, brake fluid, or any other solvent. Clean the windshield with a cloth or sponge dampened with a mild detergent, and then wash it off thoroughly with water. For additional cleaning, use Yamaha Windshield Cleaner or another high-quality windshield cleaner. Some cleaning compounds for plastics may leave scratches on the windshield. Before using such clean-

---

---

# SCOOTER CARE AND STORAGE

---

---

ers, test an area of the windshield which does not affect your visibility and which cannot be easily recognized.

## After cleaning

1. Dry the scooter with a chamois or an absorbing cloth.
2. Use a chrome polish to shine chrome, aluminum and stainless-steel parts, including the exhaust system. (Even the thermally induced discoloring of stainless-steel exhaust systems can be removed through polishing.)
3. To prevent corrosion, it is recommended to apply a corrosion protection spray on all metal, including chrome- and nickel-plated, surfaces.
4. Use spray oil as a universal cleaner to remove any remaining dirt.
5. Touch up minor paint damage caused by stones, etc.
6. Wax all painted surfaces.
7. Let the scooter dry completely before storing or covering it.

---

## WARNING

EWA10942

**Contaminants on the brakes or tires can cause loss of control.**

- **Make sure that there is no oil or wax on the brakes or tires. If necessary, clean the brake discs and brake linings with a regular brake disc cleaner or acetone, and wash the tires with warm water and a mild detergent.**
- **Before operating the scooter test its braking performance and cornering behavior.**

---

## NOTICE

ECA10800

- **Apply spray oil and wax sparingly and make sure to wipe off any excess.**
  - **Never apply oil or wax to any rubber and plastic parts, but treat them with a suitable care product.**
  - **Avoid using abrasive polishing compounds as they will wear away the paint.**
- 

---

## TIP

- Consult a Yamaha dealer for advice on what products to use.
  - Washing, rainy weather or humid climates can cause the headlight lens to fog. Turning the headlight on for a short period of time will help remove the moisture from the lens.
-

# SCOOTER CARE AND STORAGE

---

## Storage

EAU26303

### Short-term

Always store your scooter in a cool, dry place and, if necessary, protect it against dust with a porous cover. Be sure the engine and the exhaust system are cool before covering the scooter.

ECA10820

### NOTICE

- **Storing the scooter in a poorly ventilated room or covering it with a tarp, while it is still wet, will allow water and humidity to seep in and cause rust.**
- **To prevent corrosion, avoid damp cellars, stables (because of the presence of ammonia) and areas where strong chemicals are stored.**

### Long-term

Before storing your scooter for several months:

1. Follow all the instructions in the “Care” section of this chapter.

2. Drain the carburetor float chamber by loosening the drain bolt; this will prevent fuel deposits from building up. Pour the drained fuel into the fuel tank.
3. Fill up the fuel tank and add fuel stabilizer (if available) to prevent the fuel tank from rusting and the fuel from deteriorating.
4. Perform the following steps to protect the cylinder, piston rings, etc. from corrosion.
  - a. Remove the spark plug cap and spark plug.
  - b. Pour a teaspoonful of engine oil into the spark plug bore.
  - c. Install the spark plug cap onto the spark plug, and then place the spark plug on the cylinder head so that the electrodes are grounded. (This will limit sparking during the next step.)
  - d. Turn the engine over several times with the starter. (This will coat the cylinder wall with oil.)**WARNING! To prevent damage or injury from sparking, make sure to ground the**

**spark plug electrodes while turning the engine over.**

[EWA10951]

- e. Remove the spark plug cap from the spark plug, and then install the spark plug and the spark plug cap.
5. Lubricate all control cables and the pivoting points of all levers and pedals as well as of the side-stand/centerstand.
  6. Check and, if necessary, correct the tire air pressure, and then lift the scooter so that both of its wheels are off the ground. Alternatively, turn the wheels a little every month in order to prevent the tires from becoming degraded in one spot.
  7. Cover the muffler outlet with a plastic bag to prevent moisture from entering it.
  8. Remove the battery and fully charge it. Store it in a cool, dry place and charge it once a month. Do not store the battery in an excessively cold or warm place [less than 0 °C (30 °F) or more than 30



# SCOOTER CARE AND STORAGE

---

---

°C (90 °F)]. For more information on storing the battery, see page 6-17.

**TIP** \_\_\_\_\_  
Make any necessary repairs before storing the scooter.  
\_\_\_\_\_

# SPECIFICATIONS

## Dimensions:

- Overall length:  
1685 mm (66.3 in)
- Overall width:  
675 mm (26.6 in)
- Overall height:  
1058 mm (41.7 in)
- Seat height:  
768 mm (30.2 in)
- Wheelbase:  
1172 mm (46.1 in)
- Ground clearance:  
124 mm (4.88 in)
- Minimum turning radius:  
1465 mm (57.7 in)

## Weight:

- Curb weight:  
82 kg (181 lb)

## Engine:

- Engine type:  
Air cooled 2-stroke
- Cylinder arrangement:  
Single cylinder
- Displacement:  
49 cm<sup>3</sup>
- Bore × stroke:  
40.0 × 39.2 mm (1.57 × 1.54 in)
- Compression ratio:  
11.10 : 1
- Starting system:  
Kickstarter
- Lubrication system:  
Separate lubrication (Yamaha autolube)

## Engine oil:

- Type:  
YAMALUBE 2S or 2-stroke engine oil  
(JASO FC grade) or (ISO EG-C or EG-D grade)
- Engine oil quantity:  
Quantity:  
1.10 L (1.16 US qt, 0.97 Imp.qt)

## Final transmission oil:

- Type:  
SAE 10W-30 type SE motor oil
- Quantity:  
0.11 L (0.12 US qt, 0.10 Imp.qt)

## Air filter:

- Air filter element:  
Wet element

## Fuel:

- Recommended fuel:  
Premium unleaded gasoline only
- Fuel tank capacity:  
5.3 L (1.40 US gal, 1.17 Imp.gal)
- Fuel reserve amount:  
0.7 L (0.18 US gal, 0.15 Imp.gal)

## Carburetor:

- Type × quantity:  
PY-12 x 1

## Spark plug(s):

- Manufacturer/model:  
NGK/BR8HS
- Spark plug gap:  
0.6–0.7 mm (0.024–0.028 in)

## Clutch:

- Clutch type:  
Dry, centrifugal automatic

## Transmission:

- Primary reduction ratio:  
1
- Final drive:  
Gear
- Secondary reduction ratio:  
12.923 (52/13x42/13)
- Transmission type:  
V-belt automatic
- Operation:  
Centrifugal automatic type

## Chassis:

- Frame type:  
Underbone
- Caster angle:  
27.00 °
- Trail:  
90 mm (3.5 in)

## Front tire:

- Type:  
Tubeless
- Size:  
120/90-10 56J
- Manufacturer/model:  
SAVA / MC17

## Rear tire:

- Type:  
Tubeless
- Size:  
130/90-10 61J
- Manufacturer/model:  
SAVA / MC17

## Loading:

Maximum load:

185 kg (408 lb)

(Total weight of rider, passenger, cargo and accessories)

## Tire air pressure (measured on cold tires):

Loading condition:

0–90 kg (0–198 lb)

Front:

150 kPa (1.50 kgf/cm<sup>2</sup>, 22 psi)

Rear:

150 kPa (1.50 kgf/cm<sup>2</sup>, 22 psi)

Loading condition:

90–185 kg (198–408 lb)

Front:

150 kPa (1.50 kgf/cm<sup>2</sup>, 22 psi)

Rear:

150 kPa (1.50 kgf/cm<sup>2</sup>, 22 psi)

## Front wheel:

Wheel type:

Panel wheel

Rim size:

10xMT3.00

## Rear wheel:

Wheel type:

Panel wheel

Rim size:

10xMT3.50

## Front brake:

Type:

Drum brake

Operation:

Right hand operation

## Rear brake:

Type:

Drum brake

Operation:

Left hand operation

## Front suspension:

Type:

Telescopic fork

Spring/shock absorber type:

Coil spring/oil damper

Wheel travel:

70.0 mm (2.76 in)

## Rear suspension:

Type:

Unit swing

Spring/shock absorber type:

Coil spring/oil damper

Wheel travel:

60.0 mm (2.36 in)

## Electrical system:

Ignition system:

DC CDI

Charging system:

AC magneto

## Battery:

Model:

CB4-LB(GS), YB4L-B(YUASA)

Voltage, capacity:

12 V, 4.0 Ah

## Headlight:

Bulb type:

Incandescence

## Bulb voltage, wattage × quantity:

Headlight:

12 V, 25.0 W/25.0 W × 2

Tail/brake light:

12 V, 5.0 W/21.0 W × 1

Front turn signal light:

12 V, 10.0 W × 2

Rear turn signal light:

12 V, 10.0 W × 2

Meter lighting:

12 V, 1.2 W × 3

High beam indicator light:

12 V, 2.0 W × 1

Oil level warning light:

12 V, 2.0 W × 1

Turn signal indicator light:

12 V, 2.0 W × 2

## Fuses:

Main fuse:

7.5 A

# CONSUMER INFORMATION

EAU48612

## Identification numbers

Record the vehicle identification number and model label information in the spaces provided below for assistance when ordering spare parts from a Yamaha dealer or for reference in case the vehicle is stolen.

VEHICLE IDENTIFICATION  
NUMBER:

MODEL LABEL INFORMATION:

## Vehicle identification number

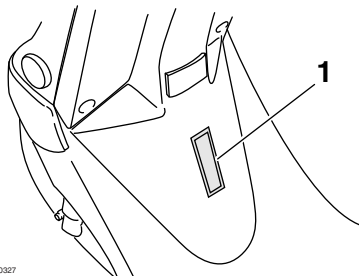

ZAUM0327

1. Vehicle identification number

The vehicle identification number is stamped into the frame.

**TIP** \_\_\_\_\_  
The vehicle identification number is used to identify your vehicle and may be used to register it with the licensing authority in your area.  
\_\_\_\_\_

EAU26410

## Model label

EAU26490

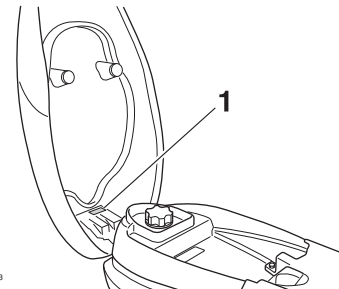

ZAUM0903

1. Model label

The model label is affixed to the bottom of the seat. (See page 3-8.) Record the information on this label in the space provided. This information will be needed when ordering spare parts from a Yamaha dealer.

- A**
- Acceleration and deceleration ..... 5-2
  - Air filter element, cleaning ..... 6-9
  - Anti-theft device housing ..... 3-9
- B**
- Battery ..... 6-17
  - Brake lever, front ..... 3-4
  - Brake lever, rear ..... 3-4
  - Brake levers, lubricating ..... 6-15
  - Brake shoes, checking ..... 6-14
  - Braking ..... 5-2
- C**
- Cables, checking and lubricating ..... 6-14
  - Carburetor, adjusting ..... 6-10
  - Care ..... 7-1
  - Catalytic converter ..... 3-6
  - Centerstand, checking and lubricating ..... 6-15
  - Cowling and panels, removing and installing ..... 6-6
- D**
- Dimmer switch ..... 3-3
- E**
- Engine break-in ..... 5-3
  - Engine oil ..... 3-7
- F**
- Final transmission oil ..... 6-8
  - Front and rear brake lever free play, adjusting ..... 6-13
  - Front fork, checking ..... 6-16
  - Fuel ..... 3-5
  - Fuel and 2-stroke engine oil tank caps... 3-5
  - Fuel consumption, tips for reducing ..... 5-3
  - Fuel gauge ..... 3-3
- Fuse, replacing ..... 6-19
- H**
- Handlebar switches ..... 3-3
  - Headlight bulb, replacing ..... 6-20
  - High beam indicator light ..... 3-2
  - Horn switch ..... 3-4
- I**
- Identification numbers ..... 9-1
  - Indicator lights and warning lights ..... 3-2
- K**
- Kickstarter ..... 3-7
- L**
- Luggage hook ..... 3-9
- M**
- Main switch/steering lock ..... 3-1
  - Maintenance and lubrication, periodic ..... 6-3
  - Maintenance, emission control system ... 6-2
  - Matte color, caution ..... 7-1
  - Model label ..... 9-1
- O**
- Oil level warning light ..... 3-2
- P**
- Parking ..... 5-4
  - Part locations ..... 2-1
- S**
- Safe-riding points ..... 1-5
  - Safety information ..... 1-1
  - Seat ..... 3-8
  - Securing bracket ..... 3-8
  - Spark plug, checking ..... 6-7
  - Specifications ..... 8-1
  - Speedometer unit ..... 3-2
  - Starting a cold engine ..... 5-1
  - Starting off ..... 5-2
- Steering, checking ..... 6-17
- Storage ..... 7-4
- T**
- Tail/brake light bulb, replacing ..... 6-20
  - Throttle grip and cable, checking and lubricating ..... 6-15
  - Throttle grip free play, checking ..... 6-10
  - Tires ..... 6-10
  - Troubleshooting ..... 6-21
  - Troubleshooting chart ..... 6-22
  - Turn signal indicator lights ..... 3-2
  - Turn signal light bulb, replacing ..... 6-21
  - Turn signal switch ..... 3-3
- V**
- Vehicle identification number ..... 9-1
- W**
- Wheel bearings, checking ..... 6-17
  - Wheels ..... 6-12







**MBK Industrie**

**Z.I. de Rouvroy 02100 Saint Quentin**

Société Anonyme au capital de 45 000 000 €

R.C St-Quentin B 329 035 422

PRINTED IN FRANCE  
2013.01 (E)