



⚠ Read this manual carefully before operating this vehicle.

OWNER'S MANUAL

Delight

XC115S

2EP-F8199-E0

 **Read this manual carefully before operating this vehicle. This manual should stay with this vehicle if it is sold.**

Welcome to the Yamaha world of motorcycling!

As the owner of the XC115S, you are benefiting from Yamaha's vast experience and newest technology regarding the design and manufacture of high-quality products, which have earned Yamaha a reputation for dependability.

Please take the time to read this manual thoroughly, so as to enjoy all advantages of your XC115S. The Owner's Manual does not only instruct you in how to operate, inspect and maintain your scooter, but also in how to safeguard yourself and others from trouble and injury.

In addition, the many tips given in this manual will help keep your scooter in the best possible condition. If you have any further questions, do not hesitate to contact your Yamaha dealer.

The Yamaha team wishes you many safe and pleasant rides. So, remember to put safety first!

Yamaha continually seeks advancements in product design and quality. Therefore, while this manual contains the most current product information available at the time of printing, there may be minor discrepancies between your scooter and this manual. If there is any question concerning this manual, please consult a Yamaha dealer.





Please read this manual carefully and completely before operating this scooter.

IMPORTANT MANUAL INFORMATION

EAU10133

Particularly important information is distinguished in this manual by the following notations:

	This is the safety alert symbol. It is used to alert you to potential personal injury hazards. Obey all safety messages that follow this symbol to avoid possible injury or death.
 WARNING	A WARNING indicates a hazardous situation which, if not avoided, could result in death or serious injury.
NOTICE	A NOTICE indicates special precautions that must be taken to avoid damage to the vehicle or other property.
TIP	A TIP provides key information to make procedures easier or clearer.

*Product and specifications are subject to change without notice.

IMPORTANT MANUAL INFORMATION

EAU37431

**XC115S
OWNER'S MANUAL
©2013 by Thai Yamaha Motor Co., Ltd.
1st edition, March 2013
All rights reserved.
Any reprinting or unauthorized use
without the written permission of
Thai Yamaha Motor Co., Ltd.
is expressly prohibited.
Printed in Thailand.**

TABLE OF CONTENTS

SAFETY INFORMATION	1-1	FOR YOUR SAFETY –		Tires	6-15
Further safe-riding points	1-5	PRE-OPERATION CHECKS	4-1	Cast wheels	6-17
DESCRIPTION	2-1	OPERATION AND IMPORTANT		Checking the front brake lever	
Left view	2-1	RIDING POINTS	5-1	free play	6-17
Right view	2-2	Starting the engine	5-1	Adjusting the rear brake lever	
Controls and instruments.....	2-3	Starting off	5-2	free play	6-18
INSTRUMENT AND CONTROL		Acceleration and deceleration	5-2	Checking the front brake pads	
FUNCTIONS	3-1	Braking	5-3	and rear brake shoes	6-18
Main switch/steering lock	3-1	Tips for reducing fuel		Checking the brake fluid level	6-19
Keyhole cover	3-2	consumption	5-3	Changing the brake fluid	6-20
Indicator lights and warning light	3-2	Engine break-in	5-3	Checking and lubricating the	
Speedometer unit	3-3	Parking	5-4	cables	6-20
Handlebar switches	3-3	PERIODIC MAINTENANCE AND		Checking and lubricating the	
Front brake lever	3-4	ADJUSTMENT	6-1	throttle grip and cable	6-20
Rear brake lever	3-4	Owner's tool kit	6-2	Lubricating the front and rear	
Fuel tank cap	3-5	Periodic maintenance chart for the		brake levers	6-21
Fuel	3-5	emission control system	6-3	Checking and lubricating the	
Catalytic converter	3-6	General maintenance and		centerstand and sidestand	6-21
Seat	3-7	lubrication chart	6-4	Checking the front fork	6-22
Helmet holders	3-8	Removing and installing the		Checking the steering	6-23
Storage compartments	3-9	cowling and panels	6-7	Checking the wheel bearings	6-23
Luggage hook	3-10	Checking the spark plug	6-8	Battery	6-23
Sidestand	3-10	Engine oil and oil strainer	6-10	Replacing the fuse	6-25
Ignition circuit cut-off system	3-11	Final transmission oil	6-12	Replacing the headlight bulb	6-26
		Air filter and V-belt case air filter		Replacing a tail/brake light bulb or	
		elements	6-13	a rear turn signal light bulb	6-27
		Adjusting the throttle grip free		Replacing a front turn signal light	
		play	6-15	bulb	6-28
		Valve clearance	6-15	Troubleshooting	6-28
				Troubleshooting chart	6-30

TABLE OF CONTENTS

SCOOTER CARE AND STORAGE ...	7-1
Matte color caution	7-1
Care	7-1
Storage	7-4
SPECIFICATIONS	8-1
CONSUMER INFORMATION	9-1
Identification numbers	9-1

EAU1026A

1

Be a Responsible Owner

As the vehicle's owner, you are responsible for the safe and proper operation of your scooter.

Scooters are single-track vehicles.

Their safe use and operation are dependent upon the use of proper riding techniques as well as the expertise of the operator. Every operator should know the following requirements before riding this scooter.

He or she should:

- Obtain thorough instructions from a competent source on all aspects of scooter operation.
- Observe the warnings and maintenance requirements in this Owner's Manual.
- Obtain qualified training in safe and proper riding techniques.
- Obtain professional technical service as indicated in this Owner's Manual and/or when made necessary by mechanical conditions.

- Never operate a scooter without proper training or instruction. Take a training course. Beginners should receive training from a certified instructor. Contact an authorized scooter dealer to find out about the training courses nearest you.

Safe Riding

Perform the pre-operation checks each time you use the vehicle to make sure it is in safe operating condition. Failure to inspect or maintain the vehicle properly increases the possibility of an accident or equipment damage. See page 4-1 for a list of pre-operation checks.

- This scooter is designed to carry the operator and a passenger.
- The failure of motorists to detect and recognize scooters in traffic is the predominating cause of automobile/scooter accidents. Many accidents have been caused by an automobile driver who did not see the scooter. Making yourself conspicu-

ous appears to be very effective in reducing the chance of this type of accident.

Therefore:

- Wear a brightly colored jacket.
- Use extra caution when you are approaching and passing through intersections, since intersections are the most likely places for scooter accidents to occur.
- Ride where other motorists can see you. Avoid riding in another motorist's blind spot.
- Never maintain a scooter without proper knowledge. Contact an authorized scooter dealer to inform you on basic scooter maintenance. Certain maintenance can only be carried out by certified staff.

- Many accidents involve inexperienced operators. In fact, many operators who have been involved in accidents do not even have a current driver's license.
 - Make sure that you are qualified and that you only lend your scooter to other qualified operators.
 - Know your skills and limits. Staying within your limits may help you to avoid an accident.
 - We recommend that you practice riding your scooter where there is no traffic until you have become thoroughly familiar with the scooter and all of its controls.
- Many accidents have been caused by error of the scooter operator. A typical error made by the operator is veering wide on a turn due to excessive speed or undercornering (insufficient lean angle for the speed).
 - Always obey the speed limit and never travel faster than warranted by road and traffic conditions.
 - Always signal before turning or changing lanes. Make sure that other motorists can see you.
- The posture of the operator and passenger is important for proper control.
 - The operator should keep both hands on the handlebar and both feet on the operator footrests during operation to maintain control of the scooter.
 - The passenger should always hold onto the operator, the seat strap or grab bar, if equipped, with both hands and keep both feet on the passenger footrests. Never carry a passenger unless he or she can firmly place both feet on the passenger footrests.
- Never ride under the influence of alcohol or other drugs.
- This scooter is designed for on-road use only. It is not suitable for off-road use.

Protective Apparel

The majority of fatalities from scooter accidents are the result of head injuries. The use of a safety helmet is the single most critical factor in the prevention or reduction of head injuries.

- Always wear an approved helmet.
- Wear a face shield or goggles. Wind in your unprotected eyes could contribute to an impairment of vision that could delay seeing a hazard.
- The use of a jacket, substantial shoes, trousers, gloves, etc., is effective in preventing or reducing abrasions or lacerations.
- Never wear loose-fitting clothes, otherwise they could catch on the control levers or wheels and cause injury or an accident.
- Always wear protective clothing that covers your legs, ankles, and feet. The engine or exhaust system become very hot during or after operation and can cause burns.
- A passenger should also observe the above precautions.

SAFETY INFORMATION

1

Avoid Carbon Monoxide Poisoning

All engine exhaust contains carbon monoxide, a deadly gas. Breathing carbon monoxide can cause headaches, dizziness, drowsiness, nausea, confusion, and eventually death.

Carbon Monoxide is a colorless, odorless, tasteless gas which may be present even if you do not see or smell any engine exhaust. Deadly levels of carbon monoxide can collect rapidly and you can quickly be overcome and unable to save yourself. Also, deadly levels of carbon monoxide can linger for hours or days in enclosed or poorly ventilated areas. If you experience any symptoms of carbon monoxide poisoning, leave the area immediately, get fresh air, and **SEEK MEDICAL TREATMENT**.

- Do not run engine indoors. Even if you try to ventilate engine exhaust with fans or open windows and doors, carbon monoxide can rapidly reach dangerous levels.
- Do not run engine in poorly ventilated or partially enclosed areas such as barns, garages, or carports.

- Do not run engine outdoors where engine exhaust can be drawn into a building through openings such as windows and doors.

Loading

Adding accessories or cargo to your scooter can adversely affect stability and handling if the weight distribution of the scooter is changed. To avoid the possibility of an accident, use extreme caution when adding cargo or accessories to your scooter. Use extra care when riding a scooter that has added cargo or accessories. Here, along with the information about accessories below, are some general guidelines to follow if loading cargo to your scooter:

The total weight of the operator, passenger, accessories and cargo must not exceed the maximum load limit.

Operation of an overloaded vehicle could cause an accident.

<p>Maximum load: 156 kg (345 lb)</p>

When loading within this weight limit, keep the following in mind:

- Cargo and accessory weight should be kept as low and close to the scooter as possible. Securely pack your heaviest items as close to the center of the vehicle as possible and make sure to distribute the weight as evenly as possible on both sides of the scooter to minimize imbalance or instability.
- Shifting weights can create a sudden imbalance. Make sure that accessories and cargo are securely attached to the scooter before riding. Check accessory mounts and cargo restraints frequently.
 - Properly adjust the suspension for your load (suspension-adjustable models only), and check the condition and pressure of your tires.
 - Never attach any large or heavy items to the handlebar, front fork, or front fender. Such items can create unstable handling or a slow steering response.
- **This vehicle is not designed to pull a trailer or to be attached to a sidecar.**

Genuine Yamaha Accessories

Choosing accessories for your vehicle is an important decision. Genuine Yamaha accessories, which are available only from a Yamaha dealer, have been designed, tested, and approved by Yamaha for use on your vehicle.

Many companies with no connection to Yamaha manufacture parts and accessories or offer other modifications for Yamaha vehicles. Yamaha is not in a position to test the products that these aftermarket companies produce. Therefore, Yamaha can neither endorse nor recommend the use of accessories not sold by Yamaha or modifications not specifically recommended by Yamaha, even if sold and installed by a Yamaha dealer.

Aftermarket Parts, Accessories, and Modifications

While you may find aftermarket products similar in design and quality to genuine Yamaha accessories, recognize that some aftermarket accessories or modifications are not suitable because of potential safety hazards to you or others. Installing aftermarket prod-

ucts or having other modifications performed to your vehicle that change any of the vehicle's design or operation characteristics can put you and others at greater risk of serious injury or death. You are responsible for injuries related to changes in the vehicle.

Keep the following guidelines in mind, as well as those provided under "Loading" when mounting accessories.

- Never install accessories or carry cargo that would impair the performance of your scooter. Carefully inspect the accessory before using it to make sure that it does not in any way reduce ground clearance or cornering clearance, limit suspension travel, steering travel or control operation, or obscure lights or reflectors.
- Accessories fitted to the handlebar or the front fork area can create instability due to improper weight distribution or aerodynamic changes. If accessories are added to the handlebar or front fork area, they must be as lightweight as possible and should be kept to a minimum.

- Bulky or large accessories may seriously affect the stability of the scooter due to aerodynamic effects. Wind may attempt to lift the scooter, or the scooter may become unstable in cross winds. These accessories may also cause instability when passing or being passed by large vehicles.
- Certain accessories can displace the operator from his or her normal riding position. This improper position limits the freedom of movement of the operator and may limit control ability, therefore, such accessories are not recommended.
- Use caution when adding electrical accessories. If electrical accessories exceed the capacity of the scooter's electrical system, an electric failure could result, which could cause a dangerous loss of lights or engine power.

SAFETY INFORMATION

1

Aftermarket Tires and Rims

The tires and rims that came with your scooter were designed to match the performance capabilities and to provide the best combination of handling, braking, and comfort. Other tires, rims, sizes, and combinations may not be appropriate. Refer to page 6-15 for tire specifications and more information on replacing your tires.

Transporting the Scooter

Be sure to observe following instructions before transporting the scooter in another vehicle.

- Remove all loose items from the scooter.
- Point the front wheel straight ahead on the trailer or in the truck bed, and choke it in a rail to prevent movement.
- Secure the scooter with tie-downs or suitable straps that are attached to solid parts of the scooter, such as the frame or upper front fork triple clamp (and not, for example, to rubber-mounted handlebars or turn signals, or parts that could break). Choose the location for the

straps carefully so the straps will not rub against painted surfaces during transport.

- The suspension should be compressed somewhat by the tie-downs, if possible, so that the scooter will not bounce excessively during transport.

EAU10373

Further safe-riding points

- Be sure to signal clearly when making turns.
- Braking can be extremely difficult on a wet road. Avoid hard braking, because the scooter could slide. Apply the brakes slowly when stopping on a wet surface.
- Slow down as you approach a corner or turn. Once you have completed a turn, accelerate slowly.
- Be careful when passing parked cars. A driver might not see you and open a door in your path.
- Railroad crossings, streetcar rails, iron plates on road construction sites, and manhole covers become extremely slippery when wet. Slow down and cross them with caution. Keep the scooter upright, otherwise it could slide out from under you.
- The brake pads could get wet when you wash the scooter. After washing the scooter, check the brakes before riding.

- Always wear a helmet, gloves, trousers (tapered around the cuff and ankle so they do not flap), and a bright colored jacket.
- Do not carry too much luggage on the scooter. An overloaded scooter is unstable. Use a strong cord to secure any luggage to the carrier (if equipped). A loose load will affect the stability of the scooter and could divert your attention from the road. (See page 1-3.)

DESCRIPTION

EAU10410

Left view

2

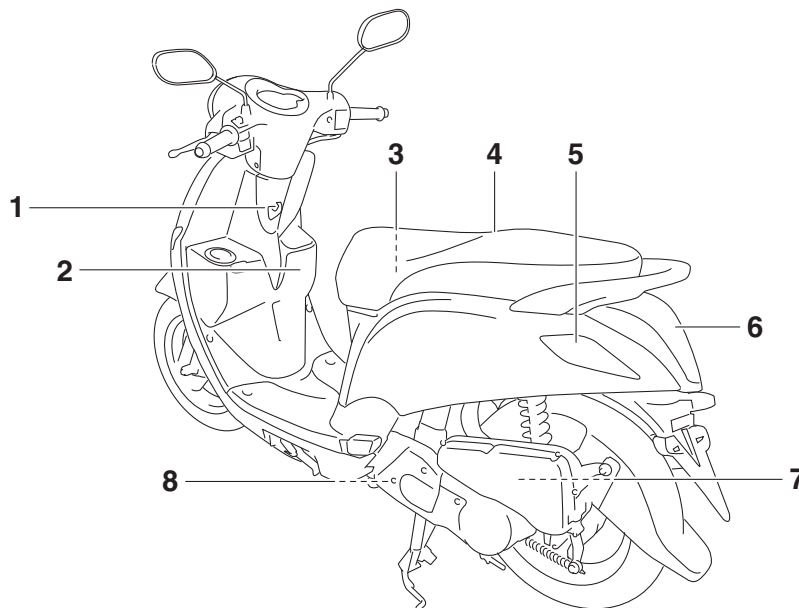

1. Luggage hook (page 3-10)
2. Front storage compartment (page 3-9)
3. Rear storage compartment (page 3-9)
4. Seat (page 3-7)
5. Rear turn signal light (page 6-27)
6. Tail/brake light (page 6-27)
7. Air filter element (page 6-13)
8. V-belt case air filter element (page 6-13)

Right view

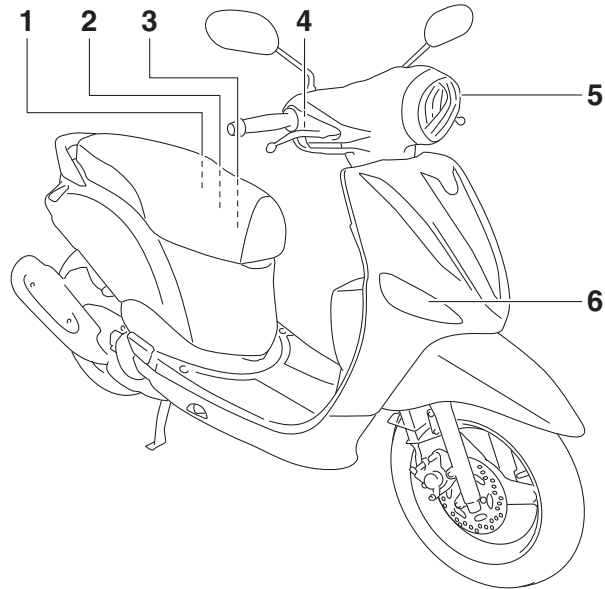

1. Owner's tool kit (page 6-2)
2. Battery (page 6-23)
3. Main fuse (page 6-25)
4. Front brake fluid reservoir (page 6-19)
5. Headlight (page 6-26)
6. Front turn signal light (page 6-28)

DESCRIPTION

EAU10430

Controls and instruments

2

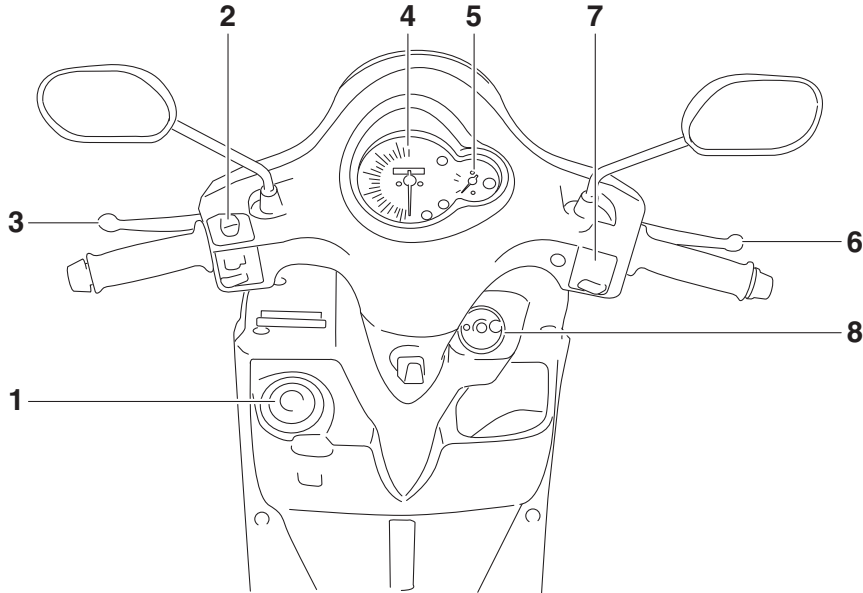

1. Fuel tank cap (page 3-5)
2. Left handlebar switches (page 3-3)
3. Rear brake lever (page 3-4)
4. Speedometer (page 3-3)
5. Fuel meter (page 3-3)
6. Front brake lever (page 3-4)
7. Right handlebar switch (page 3-3)
8. Main switch/steering lock (page 3-1)

INSTRUMENT AND CONTROL FUNCTIONS

Main switch/steering lock

EAU1030

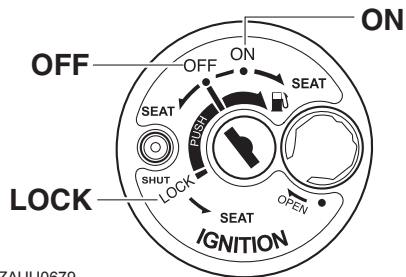

ZAUU0679

The main switch/steering lock controls the ignition and lighting systems, and is used to lock the steering, to open the seat, and to open the fuel tank cap. The various main switch positions are described below.

TIP

The main switch is equipped with a keyhole cover. (See page 3-2 for keyhole cover opening and closing procedures.)

ON

All electrical systems are supplied with power, the headlight, meter lighting, taillight and auxiliary light come on, and the engine can be started. The key cannot be removed.

EAU10650

OFF

All electrical systems are off. The key can be removed.

EAU10661

! WARNING

Never turn the key to “OFF” or “LOCK” while the vehicle is moving. Otherwise the electrical systems will be switched off, which may result in loss of control or an accident.

EWA10061

LOCK

The steering is locked, and all electrical systems are off. The key can be removed.

EAU1041

To lock the steering

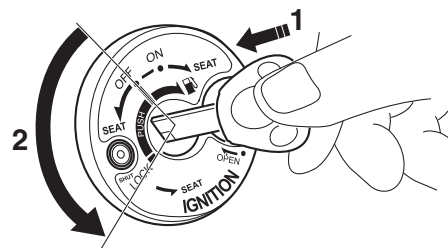

1. Push.
2. Turn.

1. Turn the handlebars all the way to the left.
2. Push the key in from the “OFF” position, and then turn it to “LOCK” while still pushing it.
3. Remove the key.

To unlock the steering

Push the key in, and then turn it to “OFF” while still pushing it.

EAU0041

! WARNING

- **Never turn the key to “OFF” or “LOCK” while the vehicle is moving; otherwise, the electri-**

INSTRUMENT AND CONTROL FUNCTIONS

cal systems will be switched off, which may result in loss of control or an accident.

- If the vehicle turns over, and after placing it upright, ensure that there is no fuel leakage. If fuel is leaking, have a Yamaha dealer check the vehicle.

3

Keyhole cover

EAU55950

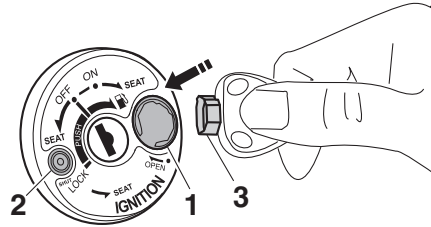

1. Keyhole cover receptacle
2. "SHUT" button
3. Key bow

To open the keyhole cover

Insert the key bow into the keyhole cover receptacle as shown, and then turn the key to "OPEN" to open the cover.

To close the keyhole cover

Press the "SHUT" button to close the keyhole cover.

Indicator lights and warning light

EAU11006

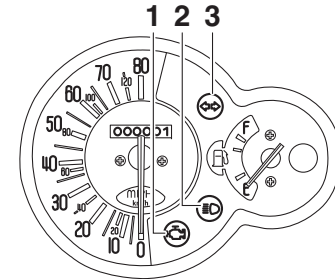

1. Engine trouble warning light "⛔"
2. High beam indicator light "≡"
3. Turn signal indicator light "← →"

Turn signal indicator light "← →"

EAU11020

This indicator light flashes when the turn signal switch is pushed to the left or right.

High beam indicator light "≡"

EAU11080

This indicator light comes on when the high beam of the headlight is switched on.

INSTRUMENT AND CONTROL FUNCTIONS

Engine trouble warning light “” EAU11484

This warning light comes on if a problem is detected in the electrical circuit monitoring the engine. If this occurs, have a Yamaha dealer check the self-diagnosis system.

The electrical circuit of the warning light can be checked by turning the key to “ON”. The warning light should come on for a few seconds, and then go off. If the warning light does not come on initially when the key is turned to “ON”, or if the warning light remains on, have a Yamaha dealer check the electrical circuit.

Speedometer unit

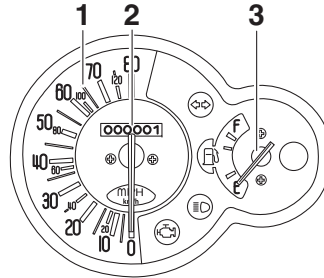

1. Speedometer
2. Odometer
3. Fuel meter

The speedometer unit is equipped with a speedometer, an odometer and a fuel meter. The speedometer shows riding speed. The odometer shows the total distance traveled. The fuel meter indicates the amount of fuel in the fuel tank.

EAUU0080



Handlebar switches

EAU1234C

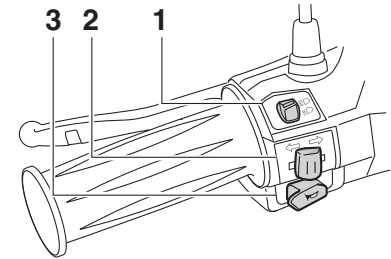
Left



ZAAU0684

1. Dimmer switch “/”
2. Turn signal switch “/”
3. Horn switch “”

Right

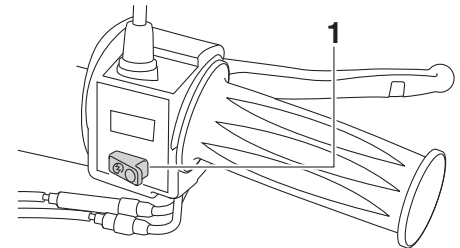



1. Start switch “”

INSTRUMENT AND CONTROL FUNCTIONS



Dimmer switch “/”

EAU12400

Set this switch to “” for the high beam and to “” for the low beam.

Turn signal switch “/”

EAU12460

To signal a right-hand turn, push this switch to “”. To signal a left-hand turn, push this switch to “”. When released, the switch returns to the center position. To cancel the turn signal lights, push the switch in after it has returned to the center position.

Horn switch “”

EAU12500

Press this switch to sound the horn.

Start switch “”

EAUM1132

Push this switch while applying the front or rear brake to crank the engine with the starter. See page 5-1 for starting instructions prior to starting the engine.

Front brake lever

EAU12901

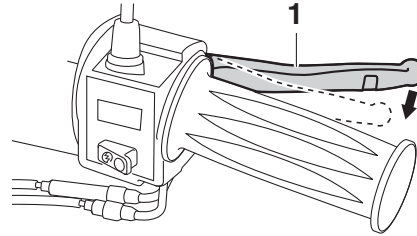

1. Front brake lever

The front brake lever is located on the right side of the handlebar. To apply the front brake, pull this lever toward the throttle grip.

Rear brake lever

EAU12951

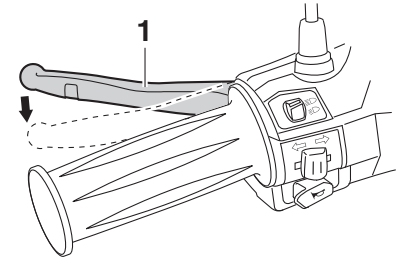

ZAUU0687

1. Rear brake lever

The rear brake lever is located on the left side of the handlebar. To apply the rear brake, pull this lever toward the handlebar grip.

INSTRUMENT AND CONTROL FUNCTIONS

Fuel tank cap

EAU1161

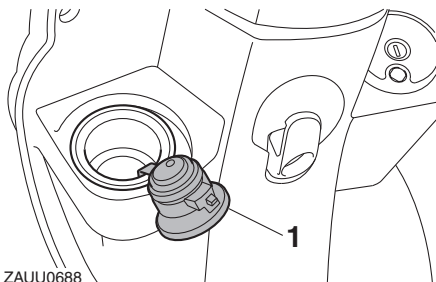

ZAUU0688

1. Fuel tank cap

To open the fuel tank cap

Insert the key into the main switch and, while pushing the key in, turn it to “”. The lock will be released and the fuel tank cap can be removed.

To install the fuel tank cap

Push the fuel tank cap down into its position. A clicking sound can be heard when the fuel tank cap is locked.

EWA10121

WARNING

Make sure that the fuel tank cap is properly closed and locked before riding. Leaking fuel is a fire hazard.

Fuel

Make sure there is sufficient gasoline in the tank.

EAU13212

EWA10881

WARNING

Gasoline and gasoline vapors are extremely flammable. To avoid fires and explosions and to reduce the risk of injury when refueling, follow these instructions.

1. Before refueling, turn off the engine and be sure that no one is sitting on the vehicle. Never refuel while smoking, or while in the vicinity of sparks, open flames, or other sources of ignition such as the pilot lights of water heaters and clothes dryers.
2. Do not overfill the fuel tank. Stop filling when the fuel reaches the bottom of the filler tube. Because fuel expands when it heats up, heat from the engine or the sun can cause fuel to spill out of the fuel tank.

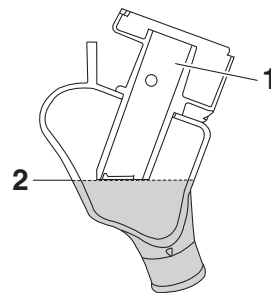

1. Fuel tank filler tube
2. Maximum fuel level
3. Wipe up any spilled fuel immediately. **NOTICE: Immediately wipe off spilled fuel with a clean, dry, soft cloth, since fuel may deteriorate painted surfaces or plastic parts.** [ECA10071]
4. Be sure to securely close the fuel tank cap.

EWA15151

WARNING

Gasoline is poisonous and can cause injury or death. Handle gasoline with care. Never siphon gasoline by mouth. If you should swallow some gasoline or inhale a lot of gasoline vapor, or get some gasoline in your eyes, see your doctor immediately. If

INSTRUMENT AND CONTROL FUNCTIONS

gasoline spills on your skin, wash with soap and water. If gasoline spills on your clothing, change your clothes.

EAU53011

Recommended fuel:

Regular unleaded gasoline (Gasohol (E10) acceptable)

Fuel tank capacity:

4.4 L (1.16 US gal, 0.97 Imp.gal)

ECA11400

NOTICE

Use only unleaded gasoline. The use of leaded gasoline will cause severe damage to internal engine parts, such as the valves and piston rings, as well as to the exhaust system.

Your Yamaha engine has been designed to use regular unleaded gasoline with a research octane number of 95 or higher. If knocking (or pinging) occurs, use a gasoline of a different brand or premium unleaded fuel. Use of unleaded fuel will extend spark plug life and reduce maintenance costs.

Gasohol

There are two types of gasohol: gasohol containing ethanol and that containing methanol. Gasohol containing ethanol can be used if the ethanol content does not exceed 10% (E10). Gasohol containing methanol is not recommended by Yamaha because it can cause damage to the fuel system or vehicle performance problems.

Catalytic converter

EAU13433

This model is equipped with a catalytic converter in the exhaust system.

EWA10862

⚠ WARNING

The exhaust system is hot after operation. To prevent a fire hazard or burns:

- **Do not park the vehicle near possible fire hazards such as grass or other materials that easily burn.**
- **Park the vehicle in a place where pedestrians or children are not likely to touch the hot exhaust system.**
- **Make sure that the exhaust system has cooled down before doing any maintenance work.**
- **Do not allow the engine to idle more than a few minutes. Long idling can cause a build-up of heat.**

INSTRUMENT AND CONTROL FUNCTIONS

NOTICE

Use only unleaded gasoline. The use of leaded gasoline will cause unreparable damage to the catalytic converter.

ECA10701

Seat

To open the seat

1. Place the motorcycle on the centerstand.
2. Turn the key to "SEAT".

TIP

Do not push inward when turning the key.

To open the seat from the "OFF" position

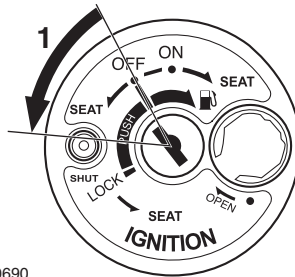

ZAUU0690

1. Seat open (in "OFF" position)

From the "OFF" position, turn the key counterclockwise to "SEAT".

EAUU1173

To open the seat from the "LOCK" position

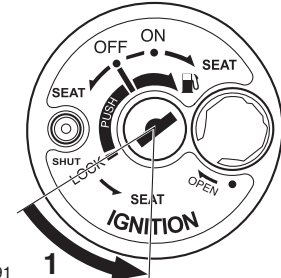

ZAUU0691

1. Seat open (in "LOCK" position)

From the "LOCK" position, turn the key counterclockwise to "SEAT".

To open the seat from the "ON" position

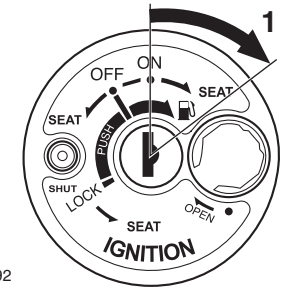

ZAUU0692

1. Seat open (in "ON" position)

INSTRUMENT AND CONTROL FUNCTIONS

From the “ON” position, turn the key clockwise to “SEAT”.

3. Fold the seat up.

To close the seat

1. Fold the seat down, and then push it down to lock it in place.
2. Remove the key from the main switch if the motorcycle will be left unattended.

TIP

Make sure that the seat is properly secured before riding.

Helmet holders

EAU37481

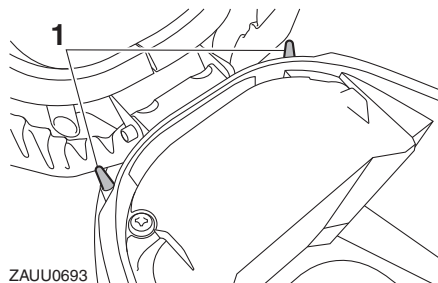

ZAUU0693

1. Helmet holder

The helmet holders are located under the seat.

To release a helmet from a helmet holder

Open the seat, remove the helmet from the helmet holder, and then close the seat.

To secure a helmet to a helmet holder

1. Open the seat. (See page 3-7.)
2. Attach a helmet to a helmet holder, and then securely close the seat.

WARNING! Never ride with a helmet attached to the helmet holder, since the helmet may hit objects, causing loss of control and possibly an accident. [EWA10161]

INSTRUMENT AND CONTROL FUNCTIONS

Storage compartments

EAU56010

Front storage compartment

The front storage compartment is located at the front of the vehicle. Use this compartment for small items.

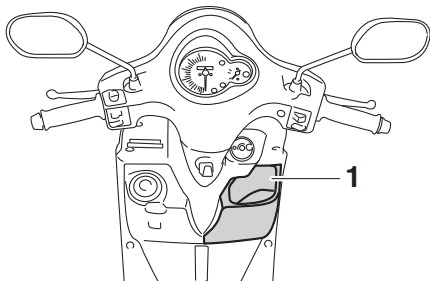

1. Front storage compartment

WARNING

EWA16440

- Do not exceed the load limit of 0.5 kg (1.1 lb) for the front storage compartment.
- Do not place anything in the front storage compartment that will interfere with your operating the vehicle.

Rear storage compartment

The rear storage compartment is located under the seat. Use this compartment for large items. (See page 3-7.)

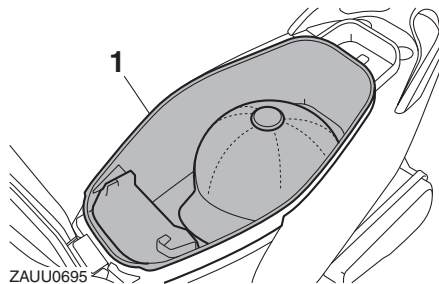

1. Rear storage compartment

EWAT1051

WARNING

- Do not exceed the load limit of 5 kg (11 lb) for the rear storage compartment.
- Do not exceed the maximum load of 156 kg (345 lb) for the vehicle.

ECA10081

NOTICE

Keep the following points in mind when using the storage compartment.

- Since the storage compartment accumulates heat when exposed to the sun and/or the engine heat, do not store anything susceptible to heat, consumables or flammable items inside it.
- To avoid humidity from spreading through the storage compartment, wrap wet articles in a plastic bag before storing them in the compartment.
- Since the storage compartment may get wet while the scooter is being washed, wrap any articles stored in the compartment in a plastic bag.
- Do not keep anything valuable or breakable in the storage compartment.

TIP

Do not leave your scooter unattended with the seat open.

INSTRUMENT AND CONTROL FUNCTIONS

Luggage hook

EAUT1072

EWAT1031

⚠ WARNING

- Do not exceed the load limit of 1.0 kg (2.2 lb) for the luggage hook.
- Do not exceed the maximum load of 156 kg (345 lb) for the vehicle.

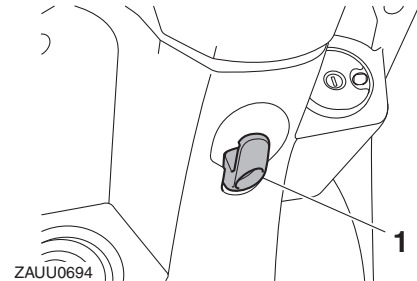

ZAUU0694
1. Luggage hook

Sidestand

EAU15305

The sidestand is located on the left side of the frame. Raise the sidestand or lower it with your foot while holding the vehicle upright.

TIP

The built-in sidestand switch is part of the ignition circuit cut-off system, which cuts the ignition in certain situations. (See the following section for an explanation of the ignition circuit cut-off system.)

EWA10241

⚠ WARNING

The vehicle must not be ridden with the sidestand down, or if the sidestand cannot be properly moved up (or does not stay up), otherwise the sidestand could contact the ground and distract the operator, resulting in a possible loss of control. Yamaha's ignition circuit cut-off system has been designed to assist the operator in fulfilling the responsibility of raising the sidestand before starting off. Therefore, check

this system regularly and have a Yamaha dealer repair it if it does not function properly.

EAUT1095

Ignition circuit cut-off system

Check the operation of the sidestand switch according to the following procedure.

INSTRUMENT AND CONTROL FUNCTIONS

3

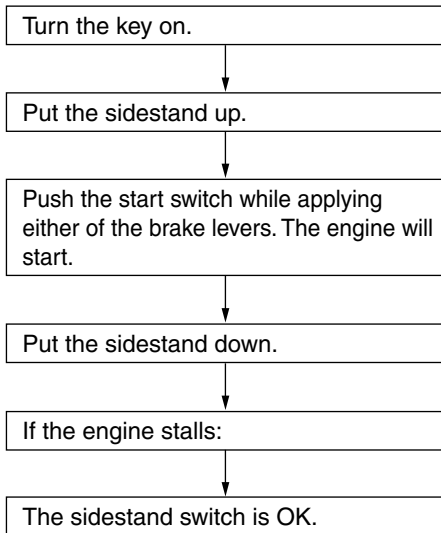

WARNING

- The vehicle must be placed on the center-stand during this inspection.
- If a malfunction is noted, have a Yamaha dealer check the system before riding.

FOR YOUR SAFETY – PRE-OPERATION CHECKS

EAU15597

Inspect your vehicle each time you use it to make sure the vehicle is in safe operating condition. Always follow the inspection and maintenance procedures and schedules described in the Owner's Manual.

EWA11151

WARNING

Failure to inspect or maintain the vehicle properly increases the possibility of an accident or equipment damage. Do not operate the vehicle if you find any problem. If a problem cannot be corrected by the procedures provided in this manual, have the vehicle inspected by a Yamaha dealer.

Before using this vehicle, check the following points:

ITEM	CHECKS	PAGE
Fuel	<ul style="list-style-type: none">• Check fuel level in fuel tank.• Refuel if necessary.• Check fuel line for leakage.	3-5
Engine oil	<ul style="list-style-type: none">• Check oil level in engine.• If necessary, add recommended oil to specified level.• Check vehicle for oil leakage.	6-10
Final transmission oil	<ul style="list-style-type: none">• Check vehicle for oil leakage.	6-12
Front brake	<ul style="list-style-type: none">• Check operation.• If soft or spongy, have Yamaha dealer bleed hydraulic system.• Check brake pads for wear.• Replace if necessary.• Check fluid level in reservoir.• If necessary, add specified brake fluid to specified level.• Check hydraulic system for leakage.	6-18, 6-19
Rear brake	<ul style="list-style-type: none">• Check operation.• Lubricate cable if necessary.• Check lever free play.• Adjust if necessary.	6-18, 6-19

FOR YOUR SAFETY – PRE-OPERATION CHECKS

ITEM	CHECKS	PAGE
Throttle grip	<ul style="list-style-type: none"> • Make sure that operation is smooth. • Check throttle grip free play. • If necessary, have Yamaha dealer adjust throttle grip free play and lubricate cable and grip housing. 	6-15, 6-20
Control cables	<ul style="list-style-type: none"> • Make sure that operation is smooth. • Lubricate if necessary. 	6-20
Wheels and tires	<ul style="list-style-type: none"> • Check for damage. • Check tire condition and tread depth. • Check air pressure. • Correct if necessary. 	6-15, 6-17
Brake levers	<ul style="list-style-type: none"> • Make sure that operation is smooth. • Lubricate lever pivoting points if necessary. 	6-21
Centerstand, sidestand	<ul style="list-style-type: none"> • Make sure that operation is smooth. • Lubricate pivots if necessary. 	6-21
Chassis fasteners	<ul style="list-style-type: none"> • Make sure that all nuts, bolts and screws are properly tightened. • Tighten if necessary. 	—
Instruments, lights, signals and switches	<ul style="list-style-type: none"> • Check operation. • Correct if necessary. 	—
Sidestand switch	<ul style="list-style-type: none"> • Check operation of ignition circuit cut-off system. • If system is not working correctly, have Yamaha dealer check vehicle. 	3-10

OPERATION AND IMPORTANT RIDING POINTS

EAU15951

Read the Owner's Manual carefully to become familiar with all controls. If there is a control or function you do not understand, ask your Yamaha dealer.

EWA10271



WARNING

Failure to familiarize yourself with the controls can lead to loss of control, which could cause an accident or injury.

EAU45310

TIP

This model is equipped with a lean angle sensor to stop the engine in case of a turnover. To start the engine after a turnover, be sure to turn the main switch to "OFF" and then to "ON". Failing to do so will prevent the engine from starting even though the engine will crank when pushing the start switch.

EAM2173

Starting the engine

ECA10250

NOTICE

See page 5-3 for engine break-in instructions prior to operating the vehicle for the first time.

In order for the ignition circuit cut-off system to enable starting, the side-stand must be up.

See page 3-11 for more information.

1. Turn the key to "ON".
2. Close the throttle completely.
3. Start the engine by pushing the start switch while applying the front or rear brake.

If the engine does not start, release the start switch, wait a few seconds, and then try again. Each starting attempt should be as short as possible to preserve the battery. Do not crank the engine more than 10 seconds on any one attempt. If the engine does not start, try with the throttle open 1/8 turn.

OPERATION AND IMPORTANT RIDING POINTS

NOTICE

ECA11042

For maximum engine life, never accelerate hard when the engine is cold!

Starting off

EAU45091

1. While pulling the rear brake lever with your left hand and holding the grab bar with your right hand, push the scooter off the centerstand.
2. Sit astride the seat, and then adjust the rear view mirrors.
3. Switch the turn signals on.
4. Check for oncoming traffic, and then slowly turn the throttle grip (on the right) in order to take off.
5. Switch the turn signals off.

Acceleration and deceleration

EAU16780

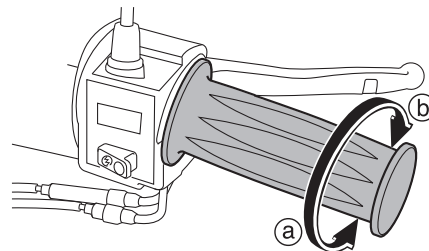

The speed can be adjusted by opening and closing the throttle. To increase the speed, turn the throttle grip in direction (a). To reduce the speed, turn the throttle grip in direction (b).

Braking

EAU16793

EWA10300

WARNING

- **Avoid braking hard or suddenly (especially when leaning over to one side), otherwise the scooter may skid or overturn.**
- **Railroad crossings, streetcar rails, iron plates on road construction sites, and manhole covers become extremely slippery when wet. Therefore, slow down when approaching such areas and cross them with caution.**
- **Keep in mind that braking on a wet road is much more difficult.**
- **Ride slowly down a hill, as braking downhill can be very difficult.**

1. Close the throttle completely.
2. Apply both front and rear brakes simultaneously while gradually increasing the pressure.

Tips for reducing fuel consumption

EAU16820

Fuel consumption depends largely on your riding style. Consider the following tips to reduce fuel consumption:

- Avoid high engine speeds during acceleration.
- Avoid high engine speeds with no load on the engine.
- Turn the engine off instead of letting it idle for an extended length of time (e.g., in traffic jams, at traffic lights or at railroad crossings).

Engine break-in

EAU16830

There is never a more important period in the life of your engine than the period between 0 and 1000 km (600 mi). For this reason, you should read the following material carefully.

Since the engine is brand new, do not put an excessive load on it for the first 1000 km (600 mi). The various parts in the engine wear and polish themselves to the correct operating clearances. During this period, prolonged full-throttle operation or any condition that might result in engine overheating must be avoided.

0–150 km (0–90 mi)

Avoid prolonged operation above 1/3 throttle.

After every hour of operation, stop the engine, and then let it cool for five to ten minutes.

Vary the engine speed from time to time. Do not operate the engine at one set throttle position.

EAU37792

OPERATION AND IMPORTANT RIDING POINTS

150–500 km (90–300 mi)

Avoid prolonged operation above 1/2 throttle.

Rev the engine freely through the gears, but do not use full throttle at any time.

500–1000 km (300–600 mi)

Avoid prolonged operation above 3/4 throttle.

1000 km (600 mi) and beyond

Avoid prolonged full-throttle operation. Vary the engine speed occasionally.

NOTICE: After 1000 km (600 mi) of operation, the engine oil must be changed, the oil filter cartridge or element replaced, and the oil strainer cleaned. If any engine trouble should occur during the engine break-in period, immediately have a Yamaha dealer check the vehicle.

[ECA10362]

EAU17213

Parking

When parking, stop the engine, and then remove the key from the main switch.

EWA10311

WARNING

- Since the engine and exhaust system can become very hot, park in a place where pedestrians or children are not likely to touch them and be burned.
- Do not park on a slope or on soft ground, otherwise the vehicle may overturn, increasing the risk of a fuel leak and fire.
- Do not park near grass or other flammable materials which might catch fire.

PERIODIC MAINTENANCE AND ADJUSTMENT

EAU17244

Periodic inspection, adjustment, and lubrication will keep your vehicle in the safest and most efficient condition possible. Safety is an obligation of the vehicle owner/operator. The most important points of vehicle inspection, adjustment, and lubrication are explained on the following pages.

The intervals given in the periodic maintenance charts should be simply considered as a general guide under normal riding conditions. However, depending on the weather, terrain, geographical location, and individual use, the maintenance intervals may need to be shortened.

EAU10321

WARNING

Failure to properly maintain the vehicle or performing maintenance activities incorrectly may increase your risk of injury or death during service or while using the vehicle. If you are not familiar with vehicle service, have a Yamaha dealer perform service.

EWA15122

WARNING

Turn off the engine when performing maintenance unless otherwise specified.

- **A running engine has moving parts that can catch on body parts or clothing and electrical parts that can cause shocks or fires.**
- **Running the engine while servicing can lead to eye injury, burns, fire, or carbon monoxide poisoning – possibly leading to death. See page 1-3 for more information about carbon monoxide.**

EWA15460

WARNING

Brake discs, calipers, drums, and linings can become very hot during use. To avoid possible burns, let brake components cool before touching them.

EAU17302

Emission controls not only function to ensure cleaner air, but are also vital to proper engine operation and maximum performance. In the following periodic maintenance charts, the services related to emissions control are grouped separately. These services require specialized data, knowledge, and equipment. Maintenance, replacement, or repair of the emission control devices and systems may be performed by any repair establishment or individual that is certified (if applicable). Yamaha dealers are trained and equipped to perform these particular services.

PERIODIC MAINTENANCE AND ADJUSTMENT

EAU17381

Owner's tool kit

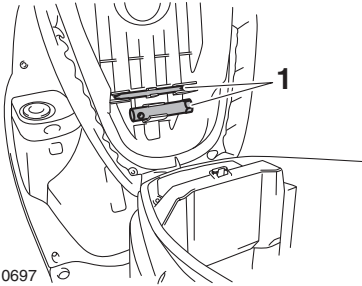

ZAUU0697

1. Owner's tool kit

The owner's tool kit is located under the seat. (See page 3-7.)

6

The service information included in this manual and the tools provided in the owner's tool kit are intended to assist you in the performance of preventive maintenance and minor repairs. However, additional tools such as a torque wrench may be necessary to perform certain maintenance work correctly.

TIP _____

If you do not have the tools or experience required for a particular job, have a Yamaha dealer perform it for you.

PERIODIC MAINTENANCE AND ADJUSTMENT

EAU46871

TIP

- The annual checks must be performed every year, except if a kilometer-based maintenance, or for the UK, a mileage-based maintenance, is performed instead.
- From 30000 km (17500 mi), repeat the maintenance intervals starting from 6000 km (3500 mi).
- Items marked with an asterisk should be performed by a Yamaha dealer as they require special tools, data and technical skills.

EAU46920

Periodic maintenance chart for the emission control system

NO.	ITEM	CHECK OR MAINTENANCE JOB	ODOMETER READING					ANNUAL CHECK
			1000 km (600 mi)	6000 km (3500 mi)	12000 km (7000 mi)	18000 km (10500 mi)	24000 km (14000 mi)	
1	* Fuel line	• Check fuel hoses for cracks or damage.		√	√	√	√	√
2	* Fuel filter	• Check condition.			√		√	
3	Spark plug	• Check condition. • Clean and regap.		√		√		
		• Replace.			√		√	
4	* Valves	• Check valve clearance. • Adjust if necessary.			√		√	
5	* Fuel injection	• Check engine idle speed.	√	√	√	√	√	√
6	* Exhaust system	• Check for leakage. • Tighten if necessary. • Replace gasket(s) if necessary.		√	√	√	√	√

PERIODIC MAINTENANCE AND ADJUSTMENT

EAU17719

General maintenance and lubrication chart

NO.	ITEM	CHECK OR MAINTENANCE JOB	ODOMETER READING					ANNUAL CHECK
			1000 km (600 mi)	6000 km (3500 mi)	12000 km (7000 mi)	18000 km (10500 mi)	24000 km (14000 mi)	
1	Air filter element	• Replace.			√		√	
2	Air filter check hose	• Clean.	√	√	√	√	√	
3 *	V-belt case air filter element	• Clean. • Replace if necessary.		√	√	√	√	
4 *	Battery	• Check battery voltage. • Change battery if necessary.	√	√	√	√	√	√
5 *	Front brake	• Check operation, fluid level and vehicle for fluid leakage.	√	√	√	√	√	√
		• Replace brake pads.	Whenever worn to the limit					
6 *	Rear brake	• Check operation and adjust brake lever free play.	√	√	√	√	√	√
		• Replace brake shoes.	Whenever worn to the limit					
7 *	Brake hose	• Check for cracks or damage. • Check for correct routing and clamping.		√	√	√	√	√
		• Replace.	Every 4 years					
8 *	Brake fluid	• Replace.	Every 2 years					
9 *	Wheels	• Check runout and for damage.		√	√	√	√	
10 *	Tires	• Check tread depth and for damage. • Replace if necessary. • Check air pressure. • Correct if necessary.		√	√	√	√	√

6

PERIODIC MAINTENANCE AND ADJUSTMENT

NO.	ITEM	CHECK OR MAINTENANCE JOB	ODOMETER READING					ANNUAL CHECK
			1000 km (600 mi)	6000 km (3500 mi)	12000 km (7000 mi)	18000 km (10500 mi)	24000 km (14000 mi)	
11	* Wheel bearings	• Check bearing for looseness or damage.		√	√	√	√	
12	* Steering bearings	• Check bearing play and steering for roughness.	√	√	√	√	√	
		• Lubricate with lithium-soap-based grease.	Every 12000 km (7500 mi)					
13	* Chassis fasteners	• Make sure that all nuts, bolts and screws are properly tightened.		√	√	√	√	√
14	Sidestand, center-stand	• Check operation. • Lubricate with lithium-soap-based grease.		√	√	√	√	√
15	* Sidestand switch	• Check operation.	√	√	√	√	√	√
16	* Front fork	• Check operation and for oil leakage.		√	√	√	√	
17	* Shock absorber assembly	• Check operation and shock absorber for oil leakage.		√	√	√	√	
18	Engine oil	• Change. (See page 6-10.) • Check oil level and vehicle for oil leakage.	√	Every 3000 km (1800 mi)				
19	* Engine oil strainer	• Clean.	√					√
20	Final transmission oil	• Check vehicle for oil leakage.	√	√		√		
		• Replace.	√		√		√	
21	* V-belt	• Replace.	Every 18000 km (10500 mi)					
22	* V-belt secondary sheave	• Lubricate.	Every 12000 km (7500 mi)					

PERIODIC MAINTENANCE AND ADJUSTMENT

NO.	ITEM	CHECK OR MAINTENANCE JOB	ODOMETER READING					ANNUAL CHECK
			1000 km (600 mi)	6000 km (3500 mi)	12000 km (7000 mi)	18000 km (10500 mi)	24000 km (14000 mi)	
23	* Front and rear brake switches	• Check operation.	√	√	√	√	√	√
24	Moving parts and cables	• Lubricate.		√	√	√	√	√
25	* Throttle grip	• Check operation. • Check throttle grip free play, and adjust if necessary. • Lubricate cable and grip housing.		√	√	√	√	√
26	* Lights, signals and switches	• Check operation. • Adjust headlight beam.	√	√	√	√	√	√

EAUT2710

6

TIP

- Air filter and V-belt filter
 - This model's air filter is equipped with a disposable oil-coated paper element, which must not be cleaned with compressed air to avoid damaging it.
 - The air filter element needs to be replaced and V-belt filter needs to be serviced more frequently when riding in unusually wet or dusty areas.
- Hydraulic brake service
 - After disassembling the brake master cylinder and caliper, always change the fluid. Regularly check the brake fluid level and fill the reservoir as required.
 - Every two years replace the internal components of the brake master cylinder and caliper, and change the brake fluid.
 - Replace the brake hose every four years and if cracked or damaged.

PERIODIC MAINTENANCE AND ADJUSTMENT

Removing and installing the cowling and panels

EAU18722

The cowling and panels shown need to be removed to perform some of the maintenance jobs described in this chapter. Refer to this section each time the cowling or a panel needs to be removed and installed.

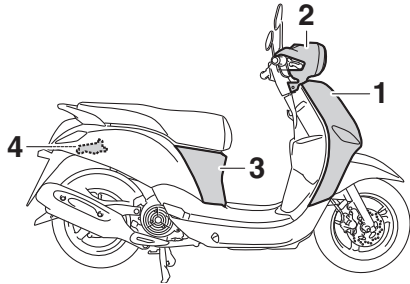

1. Cowling A
2. Panel A
3. Panel B
4. Panel C

Cowling A

EAU1090

To remove the cowling

1. Remove the screws from cowling A.

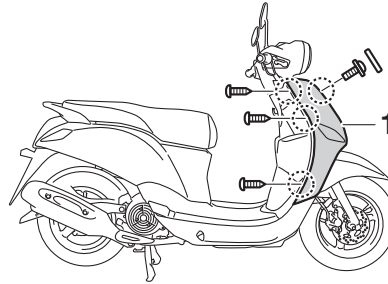

1. Cowling A

2. Pull cowling A off as shown.

TIP

When removing cowling A, pull out on the areas shown from top to bottom.

To install the cowling

1. Align the projections on cowling A with the slots of the inner cowling, and then push cowling A into the original position.
2. Install cowling A by installing the screws.

TIP

When installing cowling A, push in on the areas shown from bottom to top.

Panel A

EAU19180

To remove the panel

1. Remove cowling A. (See page 6-7.)
2. Remove the screws, and then take the panel off.

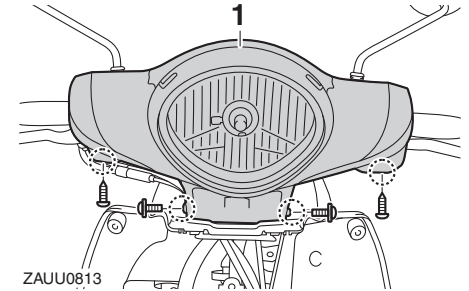

ZAUU0813

1. Panel A

To install the panel

1. Place the panel in the original position, and then install the screws.
2. Install the cowling.

Panel B

EAU19483

To remove the panel

1. Open the seat. (See page 3-7.)

PERIODIC MAINTENANCE AND ADJUSTMENT

2. Remove the screws, and then pull the panel off as shown.

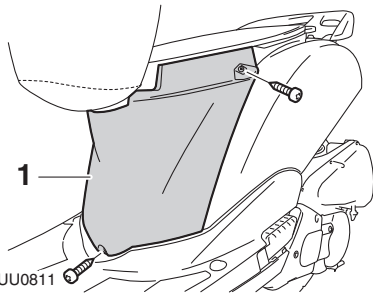

ZAUU0811

1. Panel B

To install the panel

1. Place the panel in the original position, and then install the screws.
2. Close the seat.

Panel C

EAU55910

To remove the panel

Remove the bolts and the screws, and then pull the panel off as shown.

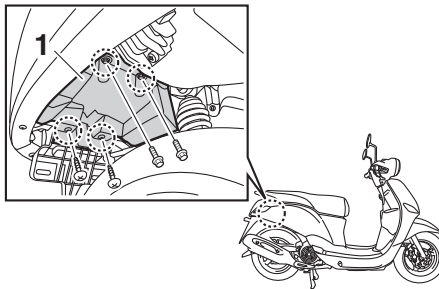

1. Panel C

To install the panel

Place the panel in the original position, and then install the screws and the bolts.

Checking the spark plug

EAUT1835

The spark plug is an important engine component, which is easy to check. Since heat and deposits will cause any spark plug to slowly erode, the spark plug should be removed and checked in accordance with the periodic maintenance and lubrication chart. In addition, the condition of the spark plug can reveal the condition of the engine.

To remove the spark plug

1. Place the vehicle on the center-stand.
2. Remove panel B. (See page 6-7.)
3. Remove the spark plug cap.
4. Remove the spark plug as shown, with the spark plug wrench included in the owner's tool kit.

PERIODIC MAINTENANCE AND ADJUSTMENT

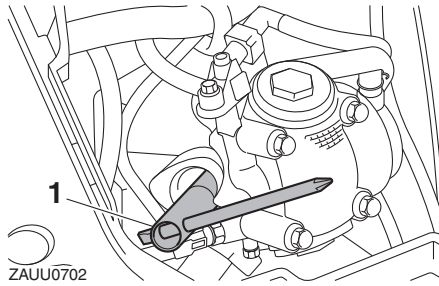

1. Spark plug wrench

To check the spark plug

1. Check that the porcelain insulator around the center electrode of the spark plug is a medium-to-light tan (the ideal color when the vehicle is ridden normally).

TIP

If the spark plug shows a distinctly different color, the engine could be operating improperly. Do not attempt to diagnose such problems yourself. Instead, have a Yamaha dealer check the vehicle.

2. Check the spark plug for electrode erosion and excessive carbon or other deposits, and replace it if necessary.

Specified spark plug:
NGK/CR6HSA

To install the spark plug

1. Measure the spark plug gap with a wire thickness gauge and, if necessary, adjust the gap to specification.

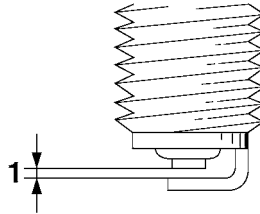

1. Spark plug gap

Spark plug gap:
0.6–0.7 mm (0.024–0.028 in)

2. Clean the surface of the spark plug gasket and its mating surface, and then wipe off any grime from the spark plug threads.
3. Install the spark plug with the spark plug wrench, and then tighten it to the specified torque.

Tightening torque:

Spark plug:
12.5 Nm (1.25 m-kgf, 9.04 ft-lbf)

TIP

If a torque wrench is not available when installing a spark plug, a good estimate of the correct torque is 1/4–1/2 turn past finger tight. However, the spark plug should be tightened to the specified torque as soon as possible.

4. Install the spark plug cap.
5. Install the panel.

PERIODIC MAINTENANCE AND ADJUSTMENT

Engine oil and oil strainer

EAU0345

The engine oil level should be checked before each ride. In addition, the oil must be changed and the oil strainer cleaned at the intervals specified in the periodic maintenance and lubrication chart.

To check the engine oil level

1. Place the vehicle on the center-stand. A slight tilt to the side can result in a false reading.
2. Start the engine, warm it up for several minutes, and then turn it off.
3. Wait a few minutes until the oil settles, remove the oil filler cap, wipe the dipstick clean, insert it back into the oil filler hole (without screwing it in), and then remove it again to check the oil level.

EWAU0030

WARNING

The muffler and muffler protector become very hot during use. To avoid possible burns, let the muffler and protector cool before removing the oil filler cap.

TIP

The engine oil should be between the minimum and maximum level marks.

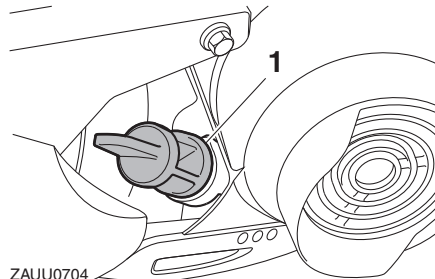

1. Engine oil filler cap

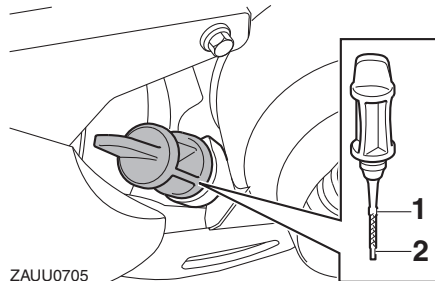

1. Maximum level mark
2. Minimum level mark

4. If the engine oil is at or below the minimum level mark, add sufficient oil of the recommended type to raise it to the correct level.
5. Insert the dipstick into the oil filler hole, and then tighten the oil filler cap.

To change the engine oil and clean the oil strainer

1. Start the engine, warm it up for several minutes, and then turn it off.
2. Place an oil pan under the engine to collect the used oil.
3. Remove the engine oil filler cap and drain bolt B to drain the oil from the crankcase. **NOTICE:** When removing the engine oil drain bolt, the O-ring, compression spring, and oil strainer will fall out. Take care not to lose these parts. [ECA11001]

PERIODIC MAINTENANCE AND ADJUSTMENT

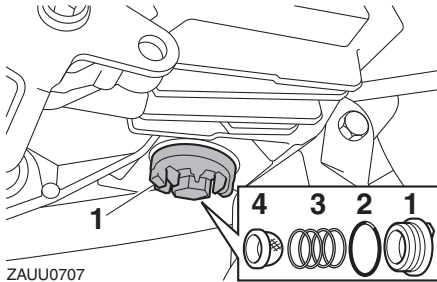

- ZAUU0707
1. Engine oil drain bolt B
 2. O-ring
 3. Compression spring
 4. Oil strainer

TIP

When only changing the engine oil, remove drain bolt A. When changing the engine oil and cleaning the engine oil strainer, remove drain bolt B also.

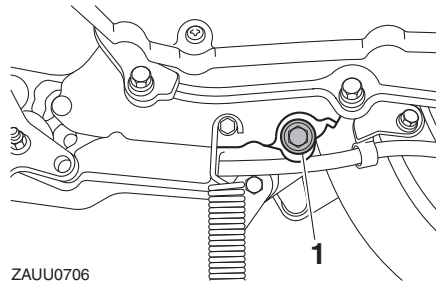

- ZAUU0706
1. Engine oil drain bolt A

4. Clean the engine oil strainer with solvent, and then check it for damage and replace it if necessary.
5. Check the O-ring for damage and replace it if necessary.
6. Install the engine oil strainer, compression spring, O-ring and engine oil drain bolt, and then tighten the drain bolt to the specified torque.

TIP

Make sure that the O-ring is properly seated.

Tightening torque:

- Engine oil drain bolt A:
20 Nm (2.0 m·kgf, 14 ft·lbf)
- Engine oil drain bolt B:
20 Nm (2.0 m·kgf, 14 ft·lbf)

7. Refill with the specified amount of the recommended engine oil, and then install and tighten the oil filler cap.

Recommended engine oil:

See page 8-1.

Oil quantity:

0.90 L (0.95 US qt, 0.79 Imp.qt)

TIP

Be sure to wipe off spilled oil on any parts after the engine and exhaust system have cooled down.

ECA11620

NOTICE

- In order to prevent clutch slippage (since the engine oil also lubricates the clutch), do not mix any chemical additives. Do not use oils with a diesel specification of “CD” or oils of a higher quality than specified. In addition, do not use oils labeled “ENERGY CONSERVING II” or higher.
- Make sure that no foreign material enters the crankcase.

PERIODIC MAINTENANCE AND ADJUSTMENT

8. Start the engine, and then let it idle for several minutes while checking it for oil leakage. If oil is leaking, immediately turn the engine off and check for the cause.
9. Turn the engine off, and then check the oil level and correct it if necessary.

Final transmission oil

EAU55920

The final transmission case must be checked for oil leakage before each ride. If any leakage is found, have a Yamaha dealer check and repair the scooter. In addition, the final transmission oil must be changed as follows at the intervals specified in the periodic maintenance and lubrication chart.

1. Start the engine, warm up the final transmission oil by riding the scooter for several minutes, and then stop the engine.
2. Place the scooter on the center-stand.
3. Place an oil pan under the final transmission case to collect the used oil.
4. Remove the final transmission oil filler cap and its O-ring from the final transmission case.

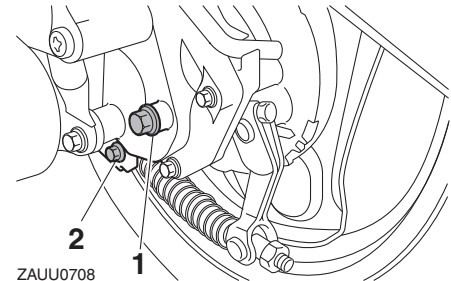

ZAUU0708

1. Final transmission oil filler cap
2. Final transmission oil drain bolt
5. Remove the final transmission oil drain bolt and its gasket to drain the oil from the final transmission case.
6. Install the final transmission oil drain bolt and its new gasket, and then tighten the bolt to the specified torque.

Tightening torque:

Final transmission oil drain bolt:
13 Nm (1.3 m·kgf, 9.4 ft·lbf)

7. Refill with the specified amount of the recommended final transmission oil. **WARNING! Make sure that no foreign material enters**

PERIODIC MAINTENANCE AND ADJUSTMENT

the final transmission case. Make sure that no oil gets on the tire or wheel. [EWA11311]

Recommended final transmission oil:

See page 8-1.

Oil quantity (oil removal) :

0.10 L (0.11 US qt, 0.09 Imp.qt)

8. Install the final transmission oil filler bolt and its new O-ring, and then tighten the oil filler bolt to the specified torque.

Tightening torque:

Final transmission oil filler bolt:
20 Nm (2.0 m·kgf, 14 ft·lbf)

9. Check the final transmission case for oil leakage. If oil is leaking, check for the cause.

Air filter and V-belt case air filter elements ^{EAU1144}

The air filter element should be replaced and the V-belt case air filter element should be cleaned at the intervals specified in the periodic maintenance and lubrication chart. Service the air filter elements more frequently if you are riding in unusually wet or dusty areas. The air filter caps and check hose must be frequently checked and cleaned if necessary.

Replacing the air filter element

1. Place the vehicle on the center-stand.
2. Remove the air filter case cover by removing the screws.

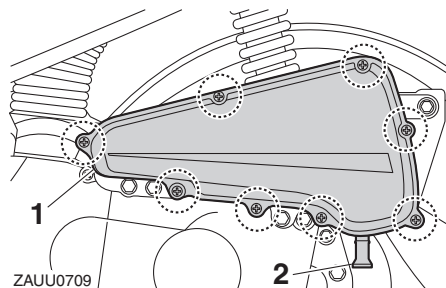

ZAUU0709

1. Air filter case cover
2. Air filter case drain hose

3. Remove the air filter element by pulling it out.

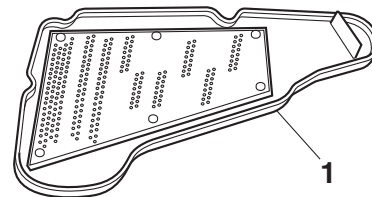

ZAUU0710

1. Air filter element
4. Insert a new air filter element into the air filter case.
5. Install the air filter case cover by installing the screws.

Cleaning the V-belt case air filter element

1. Place the vehicle on the center-stand.
2. Remove the V-belt air filter case cover by removing the bolts.

PERIODIC MAINTENANCE AND ADJUSTMENT

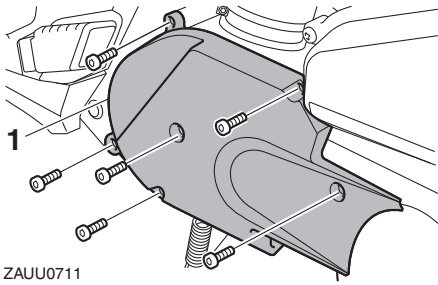

ZAUU0711

1. V-belt case air filter cover

3. Remove the element by pulling it out.

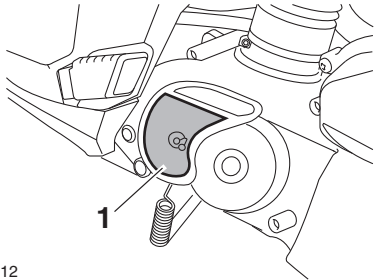

ZAUU0712

1. V-belt case air filter element

4. Clean the element with solvent, and then squeeze the remaining solvent out.
5. Check the element for damage and replace it if necessary.

6. Apply oil of the recommended type to the entire surface of the element, and then squeeze the excess oil out. **WARNING!** Use only a dedicated parts cleaning solvent. To avoid the risk of fire or explosion, do not use gasoline or solvents with a low flash point. [EWA10432] **NOTICE:** To avoid damaging the air filter element, handle it gently and carefully, and do not twist it. [ECA10522]

TIP

The element should be wet but not dripping.

Recommended oil:

Yamaha foam air filter oil or other quality foam air filter oil

7. Install the element into the filter case.
8. Place the air filter case cover in its original position, and then install the bolts. **NOTICE:** Make sure that each filter element is properly seated in its case. The engine should never be operated without the filter elements in-

stalled, otherwise the piston(s) and/or cylinder(s) may become excessively worn. [ECA10532]

Cleaning the air filter caps and check hose

1. Check each cap at the bottom of the air filter case and the hose at the bottom of the V-belt case for accumulated dirt or water.
2. If dirt or water is visible, remove the hose or caps from their clamp.
3. Drain dirt or water into a proper container.
4. Install the air filter check hose or caps to the original position.

TIP

The air filter check hose or caps need more frequent cleaning after riding in the rain, washing the vehicle, or in case of overturn. If the check hose or caps are clogged, have a Yamaha dealer service the vehicle.

Adjusting the throttle grip free play

EAU1210

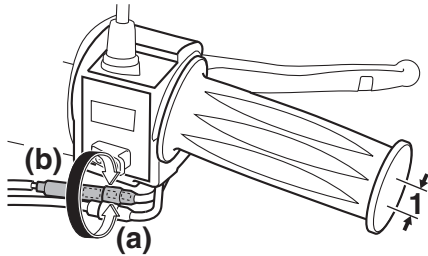

1. Throttle grip free play

The throttle grip free play should measure 1.5–3.5 mm (0.06–0.14 in) as shown. Periodically check the throttle grip free play and, if necessary, adjust it as follows.

1. Loosen the locknut.
2. To increase the throttle grip free play, turn the adjusting nut in direction (a). To decrease the throttle grip free play, turn the adjusting nut in direction (b).
3. Tighten the locknut.

Valve clearance

EAU21401

The valve clearance changes with use, resulting in improper air-fuel mixture and/or engine noise. To prevent this from occurring, the valve clearance must be adjusted by a Yamaha dealer at the intervals specified in the periodic maintenance and lubrication chart.

Tires

EAU55930

Tires are the only contact between the vehicle and the road. Safety in all conditions of riding depends on a relatively small area of road contact. Therefore, it is essential to maintain the tires in good condition at all times and replace them at the appropriate time with the specified tires.

Tire air pressure

The tire air pressure should be checked and, if necessary, adjusted before each ride.

EWA10503

WARNING

Operation of this vehicle with improper tire pressure may cause severe injury or death from loss of control.

- **The tire air pressure must be checked and adjusted on cold tires (i.e., when the temperature of the tires equals the ambient temperature).**
- **The tire air pressure must be adjusted in accordance with the riding speed and with the total**

PERIODIC MAINTENANCE AND ADJUSTMENT

weight of rider, passenger, cargo, and accessories approved for this model.

Tire air pressure (measured on cold tires):

0–90 kg (0–198 lb):

Front:

175 kPa (1.75 kgf/cm², 25 psi)

Rear:

200 kPa (2.00 kgf/cm², 29 psi)

90–156 kg (198–344 lb):

Front:

175 kPa (1.75 kgf/cm², 25 psi)

Rear:

200 kPa (2.00 kgf/cm², 29 psi)

Maximum load*:

156 kg (345 lb)

* Total weight of rider, passenger, cargo and accessories

EWA10511

WARNING

Never overload your vehicle. Operation of an overloaded vehicle could cause an accident.

Tire inspection

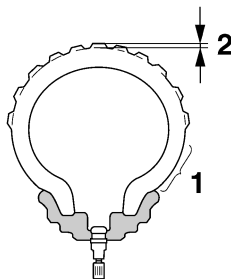

1. Tire sidewall
2. Tire tread depth

The tires must be checked before each ride. If the center tread depth reaches the specified limit, if the tire has a nail or glass fragments in it, or if the sidewall is cracked, have a Yamaha dealer replace the tire immediately.

Minimum tire tread depth (front and rear):

1.6 mm (0.06 in)

TIP

The tire tread depth limits may differ from country to country. Always comply with the local regulations.

Tire information

This vehicle is equipped with cast wheels and tubeless tires.

Tires age, even if they have not been used or have only been used occasionally. Cracking of the tread and sidewall rubber, sometimes accompanied by carcass deformation, is an evidence of ageing. Old and aged tires shall be checked by tire specialists to ascertain their suitability for further use.

After extensive tests, only the tires listed below have been approved for this model by Yamaha Motor Co., Ltd.

Front tire:

Size:

90/90-12 44J

Manufacturer/model:

MAXXIS/M6219

Rear tire:

Size:

90/90-12 54J

Manufacturer/model:

MAXXIS/M6220

EWA10471

WARNING

- Have a Yamaha dealer replace excessively worn tires. Besides being illegal, operating the vehi-

PERIODIC MAINTENANCE AND ADJUSTMENT

cle with excessively worn tires decreases riding stability and can lead to loss of control.

- The replacement of all wheel and brake-related parts, including the tires, should be left to a Yamaha dealer, who has the necessary professional knowledge and experience to do so.
- Ride at moderate speeds after changing a tire since the tire surface must first be “broken in” for it to develop its optimal characteristics.

Cast wheels

EAU21962

To maximize the performance, durability, and safe operation of your vehicle, note the following points regarding the specified wheels.

- The wheel rims should be checked for cracks, bends, warpage or other damage before each ride. If any damage is found, have a Yamaha dealer replace the wheel. Do not attempt even the smallest repair to the wheel. A deformed or cracked wheel must be replaced.
- The wheel should be balanced whenever either the tire or wheel has been changed or replaced. An unbalanced wheel can result in poor performance, adverse handling characteristics, and a shortened tire life.

Checking the front brake lever free play

EAU49350

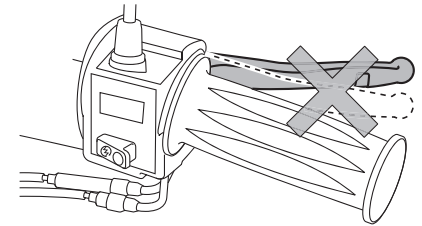

There should be no free play at the brake lever end. If there is free play, have a Yamaha dealer inspect the brake system.

EWA14211

WARNING

A soft or spongy feeling in the brake lever can indicate the presence of air in the hydraulic system. If there is air in the hydraulic system, have a Yamaha dealer bleed the system before operating the vehicle. Air in the hydraulic system will diminish the braking performance, which may result in loss of control and an accident.

PERIODIC MAINTENANCE AND ADJUSTMENT

Adjusting the rear brake lever free play

EAU22170

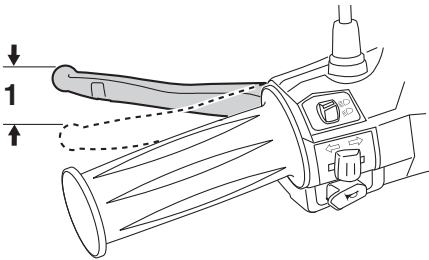

1. Rear brake lever free play

The brake lever free play should measure 10.0–20.0 mm (0.39–0.79 in) as shown. Periodically check the brake lever free play and, if necessary, adjust it as follows.

To increase the brake lever free play, turn the adjusting nut at the brake shoe plate in direction (a). To decrease the brake lever free play, turn the adjusting nut in direction (b).

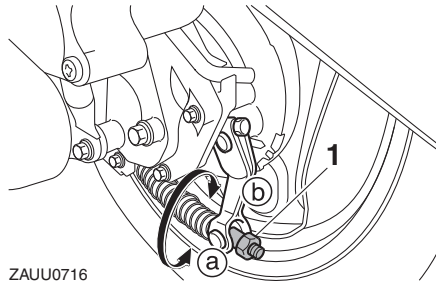

ZAUU0716

1. Rear brake lever free play adjusting nut



WARNING
If proper adjustment cannot be obtained as described, have a Yamaha dealer make this adjustment.

EWA10650

Checking the front brake pads and rear brake shoes

EAU22380

The front brake pads and the rear brake shoes must be checked for wear at the intervals specified in the periodic maintenance and lubrication chart.

Front brake pads

EAU22430

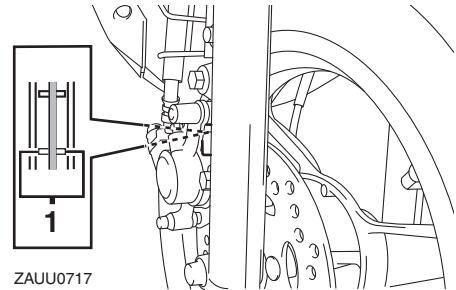

ZAUU0717

1. Brake pad wear indicator groove

Each front brake pad is provided with wear indicator grooves, which allow you to check the brake pad wear without having to disassemble the brake. To check the brake pad wear, check the wear indicator grooves. If a brake pad has worn to the point that the wear

PERIODIC MAINTENANCE AND ADJUSTMENT

indicator grooves have almost disappeared, have a Yamaha dealer replace the brake pads as a set.

Rear brake shoes

EAU22540

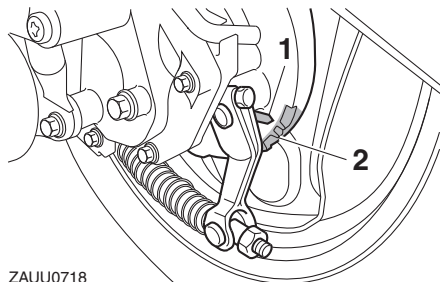

ZAUU0718

1. Brake shoe wear indicator
2. Brake shoe wear limit line

The rear brake is provided with a wear indicator, which allows you to check the brake shoe wear without having to disassemble the brake. To check the brake shoe wear, check the position of the wear indicator while applying the brake. If a brake shoe has worn to the point that the wear indicator reaches the wear limit line, have a Yamaha dealer replace the brake shoes as a set.

Checking the brake fluid level

EAUU0830

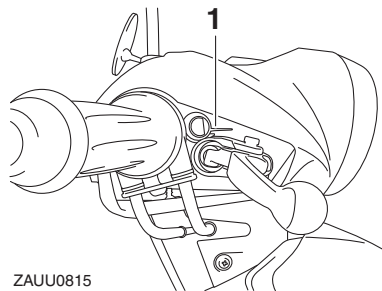

ZAUU0815

1. Minimum level mark

Insufficient brake fluid may allow air to enter the brake system, possibly causing it to become ineffective.

Before riding, check that the brake fluid is above the minimum level mark and replenish if necessary. A low brake fluid level may indicate worn brake pads and/or brake system leakage. If the brake fluid level is low, be sure to check the brake pads for wear and the brake system for leakage.

Observe these precautions:

- When checking the fluid level, make sure that the top of the master cylinder is level by turning the handlebars.

- Use only the recommended quality brake fluid, otherwise the rubber seals may deteriorate, causing leakage and poor braking performance.

Recommended brake fluid:

YAMAHA GENUINE BRAKE FLUID
or equivalent DOT3 or DOT4

- Refill with the same type of brake fluid. Mixing fluids may result in a harmful chemical reaction and lead to poor braking performance.
- Be careful that water does not enter the master cylinder when refilling. Water will significantly lower the boiling point of the fluid and may result in vapor lock.
- Brake fluid may deteriorate painted surfaces or plastic parts. Always clean up spilled fluid immediately.
- As the brake pads wear, it is normal for the brake fluid level to gradually go down. However, if the brake fluid level goes down suddenly, have a Yamaha dealer check the cause.

PERIODIC MAINTENANCE AND ADJUSTMENT

Changing the brake fluid

EAU22722

Have a Yamaha dealer change the brake fluid at the intervals specified in the periodic maintenance and lubrication chart. In addition, have the oil seals of the brake master cylinder and caliper as well as the brake hose replaced at the intervals listed below or whenever they are damaged or leaking.

- Oil seals: Replace every two years.
- Brake hose: Replace every four years.

Checking and lubricating the cables

EAU23096

The operation of all control cables and the condition of the cables should be checked before each ride, and the cables and cable ends should be lubricated if necessary. If a cable is damaged or does not move smoothly, have a Yamaha dealer check or replace it. **WARNING! Damage to the outer housing of cables may result in internal rusting and cause interference with cable movement. Replace damaged cables as soon as possible to prevent unsafe conditions.**

[EWA10711]

Recommended lubricant:

Yamaha cable lubricant or other suitable cable lubricant

Checking and lubricating the throttle grip and cable

EAU23114

The operation of the throttle grip should be checked before each ride. In addition, the cable should be lubricated by a Yamaha dealer at the intervals specified in the periodic maintenance chart. The throttle cable is equipped with a rubber cover. Make sure that the cover is securely installed. Even though the cover is installed correctly, it does not completely protect the cable from water entry. Therefore, use care not to pour water directly onto the cover or cable when washing the vehicle. If the cable or cover becomes dirty, wipe clean with a moist cloth.

PERIODIC MAINTENANCE AND ADJUSTMENT

Lubricating the front and rear brake levers EAU43642

The pivoting points of the front and rear brake levers must be lubricated at the intervals specified in the periodic maintenance and lubrication chart.

Front brake lever

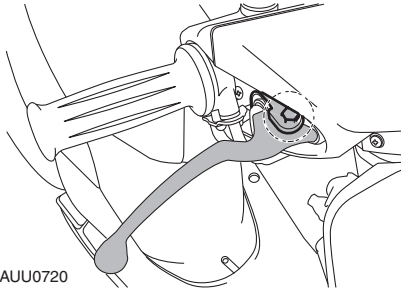

ZAUU0720

Rear brake lever

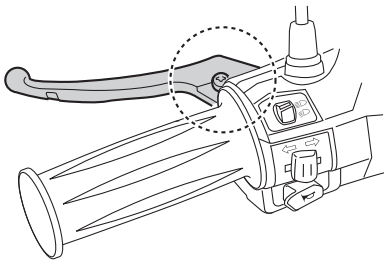

ZAUU0721

Recommended lubricants:

- Front brake lever:
 - Silicone grease
- Rear brake lever:
 - Lithium-soap-based grease

Checking and lubricating the centerstand and sidestand EAU23213

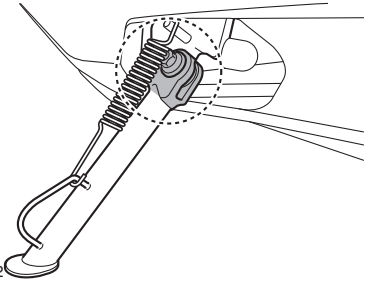

ZAUU0722

The operation of the centerstand and sidestand should be checked before each ride, and the pivots and metal-to-metal contact surfaces should be lubricated if necessary.

WARNING

If the centerstand or sidestand does not move up and down smoothly, have a Yamaha dealer check or repair it. Otherwise, the centerstand or sidestand could contact the ground and distract the operator, resulting in a possible loss of control.

EWA10741

PERIODIC MAINTENANCE AND ADJUSTMENT

Recommended lubricant:
Lithium-soap-based grease

EAU23272

Checking the front fork

The condition and operation of the front fork must be checked as follows at the intervals specified in the periodic maintenance and lubrication chart.

To check the condition

Check the inner tubes for scratches, damage and excessive oil leakage.

To check the operation

1. Place the vehicle on a level surface and hold it in an upright position. **WARNING! To avoid injury, securely support the vehicle so there is no danger of it falling over.** [EWA10751]
2. While applying the front brake, push down hard on the handlebars several times to check if the front fork compresses and rebounds smoothly.

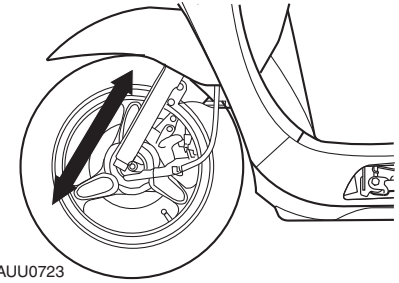

ZAUU0723

ECA10590

NOTICE

If any damage is found or the front fork does not operate smoothly, have a Yamaha dealer check or repair it.

PERIODIC MAINTENANCE AND ADJUSTMENT

Checking the steering

EAU45511

Worn or loose steering bearings may cause danger. Therefore, the operation of the steering must be checked as follows at the intervals specified in the periodic maintenance and lubrication chart.

1. Place the vehicle on the center-stand. **WARNING! To avoid injury, securely support the vehicle so there is no danger of it falling over.** [EWA10751]
2. Hold the lower ends of the front fork legs and try to move them forward and backward. If any free play can be felt, have a Yamaha dealer check or repair the steering.

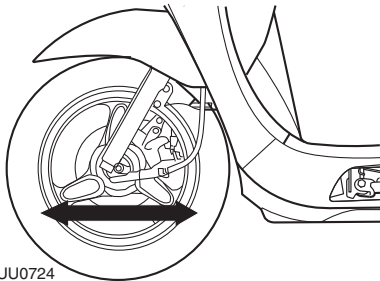

ZAUU0724

Checking the wheel bearings

EAU23291

The front and rear wheel bearings must be checked at the intervals specified in the periodic maintenance and lubrication chart. If there is play in the wheel hub or if the wheel does not turn smoothly, have a Yamaha dealer check the wheel bearings.

Battery

EAUU0922

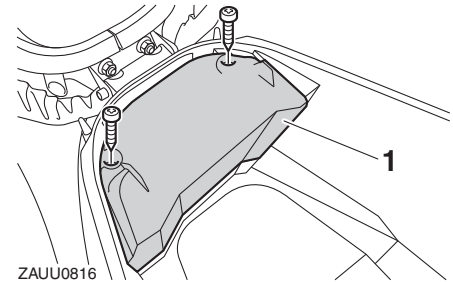

ZAUU0816

1. Battery cover

This model is equipped with a VRLA (Valve Regulated Lead Acid) battery. There is no need to check the electrolyte or to add distilled water. However, the battery lead connections need to be checked and, if necessary, tightened.

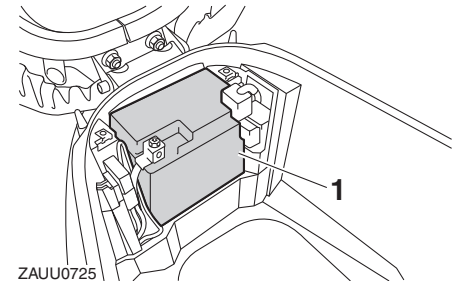

ZAUU0725

1. Battery

PERIODIC MAINTENANCE AND ADJUSTMENT

EWA10760

WARNING

- Electrolyte is poisonous and dangerous since it contains sulfuric acid, which causes severe burns. Avoid any contact with skin, eyes or clothing and always shield your eyes when working near batteries. In case of contact, administer the following **FIRST AID**.
 - **EXTERNAL:** Flush with plenty of water.
 - **INTERNAL:** Drink large quantities of water or milk and immediately call a physician.
 - **EYES:** Flush with water for 15 minutes and seek prompt medical attention.
- Batteries produce explosive hydrogen gas. Therefore, keep sparks, flames, cigarettes, etc., away from the battery and provide sufficient ventilation when charging it in an enclosed space.

- **KEEP THIS AND ALL BATTERIES OUT OF THE REACH OF CHILDREN.**

ECA10620

NOTICE

Never attempt to remove the battery cell seals, as this would permanently damage the battery.

To charge the battery

Have a Yamaha dealer charge the battery as soon as possible if it seems to have discharged. Keep in mind that the battery tends to discharge more quickly if the vehicle is equipped with optional electrical accessories.

ECA16521

NOTICE

To charge a **VRLA (Valve Regulated Lead Acid) battery**, a special (constant-voltage) battery charger is required. Using a conventional battery charger will damage the battery.

To store the battery

1. If the vehicle will not be used for more than one month, remove the battery, fully charge it, and then

place it in a cool, dry place. **NOTICE:** When removing the battery, be sure the key is turned to “OFF”, then disconnect the negative lead before disconnecting the positive lead.

[ECA16302]

2. If the battery will be stored for more than two months, check it at least once a month and fully charge it if necessary.
3. Fully charge the battery before installation. **NOTICE:** When installing the battery, be sure the key is turned to “OFF”, then connect the positive lead before connecting the negative lead.
4. After installation, make sure that the battery leads are properly connected to the battery terminals.

[ECA16840]

ECA16530

NOTICE

Always keep the battery charged. Storing a discharged battery can cause permanent battery damage.

PERIODIC MAINTENANCE AND ADJUSTMENT

NOTICE

ECAU0050

Do not ride the vehicle with the battery disconnected or with a low-charged battery. This will cause hard engine starting, decreased headlight life, and the flasher lights may not operate properly.

Replacing the fuse

EAU23482

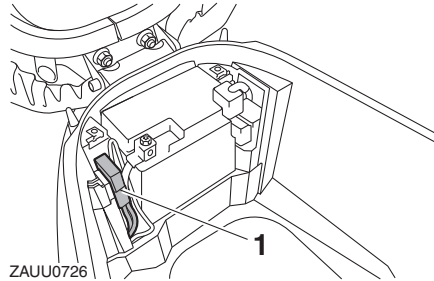

ZAUU0726

1. Fuse

The fuse holder is located under the seat. (See page 3-7.)

If the fuse is blown, replace it as follows.

1. Turn the key to “OFF” and turn off all electrical circuits.
2. Remove the blown fuse, and then install a new fuse of the specified amperage. **WARNING! Do not use a fuse of a higher amperage rating than recommended to avoid causing extensive damage to the electrical system and possibly a fire.** [EWA15131]
3. Turn the key to “ON” and turn on the electrical circuits to check if the devices operate.
4. If the fuse immediately blows again, have a Yamaha dealer check the electrical system.

Specified fuse:

15.0 A

PERIODIC MAINTENANCE AND ADJUSTMENT

Replacing the headlight bulb

EAUT2134

This model is equipped with a halogen bulb headlight. If the headlight bulb burns out, replace it as follows.

ECA10650

NOTICE

Take care not to damage the following parts:

- **Headlight bulb**

Do not touch the glass part of the headlight bulb to keep it free from oil, otherwise the transparency of the glass, the luminosity of the bulb, and the bulb life will be adversely affected. Thoroughly clean off any dirt and fingerprints on the headlight bulb using a cloth moistened with alcohol or thinner.

- **Headlight lens**

Do not affix any type of tinted film or stickers to the headlight lens.

Do not use a headlight bulb of a wattage higher than specified.

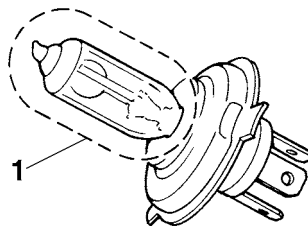

1. Do not touch the glass part of the bulb.

1. Place the vehicle on the center-stand.
2. Remove panel A. (See page 6-7.)
3. Disconnect the headlight coupler, and then remove the bulb cover.

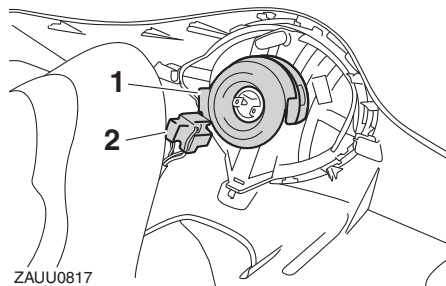

ZAUU0817

1. Headlight cover
2. Headlight bulb socket

4. Unhook the headlight bulb holder, and then remove the burnt-out bulb.

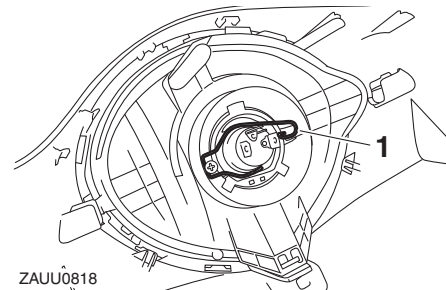

ZAUU0818

1. Headlight bulb holder
5. Place a new headlight bulb into position, and then secure it with the bulb holder.
6. Install the headlight bulb cover, and then connect the coupler.
7. Install the panel.
8. Have a Yamaha dealer adjust the headlight beam if necessary.

PERIODIC MAINTENANCE AND ADJUSTMENT

Replacing a tail/brake light bulb or a rear turn signal light bulb EAU1500

If a tail/brake light bulb or a rear turn signal light bulb burns out, replace it as follows.

Tail/brake light bulb

1. Remove panel C. (See page 6-7.)
2. Remove the socket (together with the bulb) by turning it counter-clockwise.

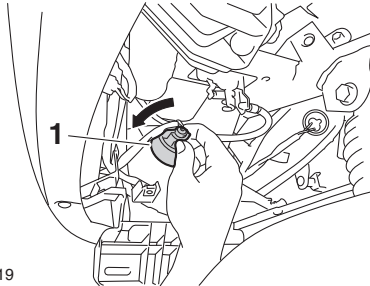

ZAUU0819

1. Tail/brake light bulb socket

3. Remove the burnt-out bulb by pushing it in and turning it counter-clockwise.

4. Insert a new bulb into the socket, push it in, and then turn it clockwise until it stops.

ECAU0090

NOTICE

If a taillight bulb of different wattage than recommended is used, it may cause the battery to discharge or affect the taillight lighting.

5. Install the socket (together with the bulb) by turning it clockwise.
6. Install the panel.

Rear turn signal light bulb

1. Remove panel C. (See page 6-7.)
2. Remove the socket (together with the bulb) by turning it counter-clockwise.

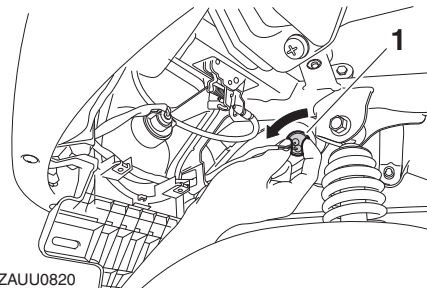

ZAUU0820

1. Turn signal light bulb socket

3. Remove the burnt-out bulb by pulling it out.
4. Insert a new bulb into the socket.

ECAU0080

NOTICE

If a turn signal light bulb of different wattage than recommended is used, the turn signal light flashing may be affected.

5. Install the socket (together with the bulb) by turning it clockwise.
6. Install the panel.

PERIODIC MAINTENANCE AND ADJUSTMENT

Replacing a front turn signal light bulb

EAU55940

ECA10670

NOTICE

It is advisable to have a Yamaha dealer perform this job.

1. Place the scooter on the center-stand.
2. Remove cowling A. (See page 6-7.)
3. Remove the turn signal light bulb socket (together with the bulb) by turning it counterclockwise.

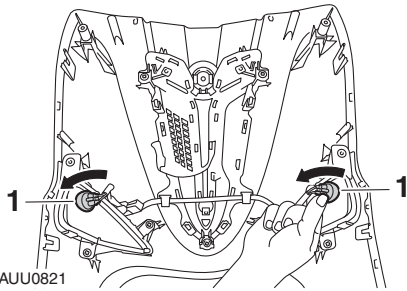

ZAUU0821

1. Turn signal light bulb socket
4. Remove the burnt-out bulb by pulling it out.
5. Insert a new bulb into the socket.

6. Install the socket (together with the bulb) by turning it clockwise.
7. Install the cowling.

EAU25861

Troubleshooting

Although Yamaha scooters receive a thorough inspection before shipment from the factory, trouble may occur during operation. Any problem in the fuel, compression, or ignition systems, for example, can cause poor starting and loss of power.

The following troubleshooting chart represents a quick and easy procedure for checking these vital systems yourself. However, should your scooter require any repair, take it to a Yamaha dealer, whose skilled technicians have the necessary tools, experience, and know-how to service the scooter properly.

Use only genuine Yamaha replacement parts. Imitation parts may look like Yamaha parts, but they are often inferior, have a shorter service life and can lead to expensive repair bills.

EWA15141

WARNING

When checking the fuel system, do not smoke, and make sure there are no open flames or sparks in the area, including pilot lights from water

PERIODIC MAINTENANCE AND ADJUSTMENT

heaters or furnaces. Gasoline or gasoline vapors can ignite or explode, causing severe injury or property damage.

PERIODIC MAINTENANCE AND ADJUSTMENT

EAU25904

Troubleshooting chart

1. Fuel

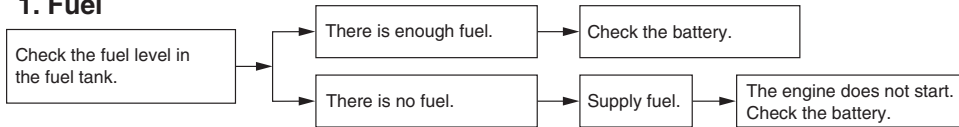

2. Battery

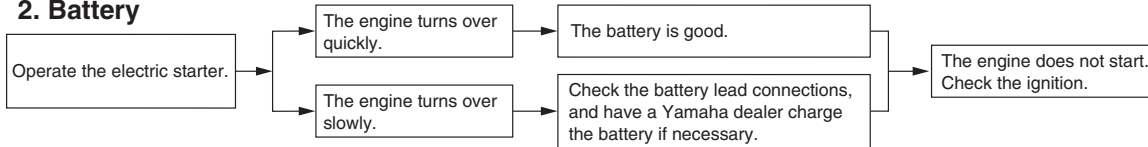

3. Ignition

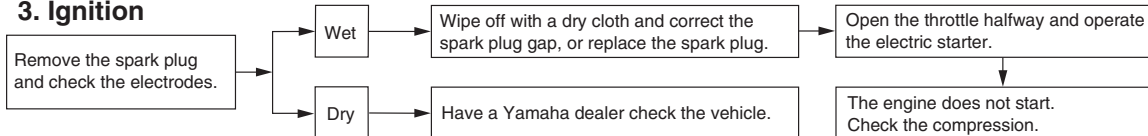

4. Compression

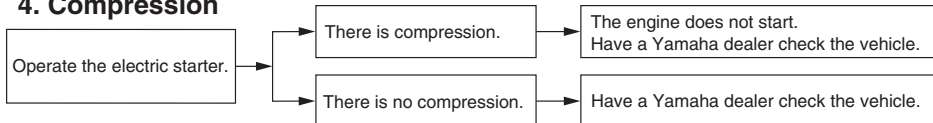

Matte color caution

EAU37833

NOTICE

Some models are equipped with matte colored finished parts. Be sure to consult a Yamaha dealer for advice on what products to use before cleaning the vehicle. Using a brush, harsh chemical products or cleaning compounds when cleaning these parts will scratch or damage their surface. Wax also should not be applied to any matte colored finished parts.

ECA15192

Care

EAU26095

While the open design of a scooter reveals the attractiveness of the technology, it also makes it more vulnerable. Rust and corrosion can develop even if high-quality components are used. A rusty exhaust pipe may go unnoticed on a car, however, it detracts from the overall appearance of a scooter. Frequent and proper care does not only comply with the terms of the warranty, but it will also keep your scooter looking good, extend its life and optimize its performance.

Before cleaning

1. Cover the muffler outlet with a plastic bag after the engine has cooled down.
2. Make sure that all caps and covers as well as all electrical couplers and connectors, including the spark plug cap, are tightly installed.
3. Remove extremely stubborn dirt, like oil burnt onto the crankcase, with a degreasing agent and a brush, but never apply such prod-

ucts onto seals, gaskets and wheel axles. Always rinse the dirt and degreaser off with water.

Cleaning

ECA10783

NOTICE

- Avoid using strong acidic wheel cleaners, especially on spoked wheels. If such products are used on hard-to-remove dirt, do not leave the cleaner on the affected area any longer than instructed. Also, thoroughly rinse the area off with water, immediately dry it, and then apply a corrosion protection spray.
- Improper cleaning can damage plastic parts (such as cowlings, panels, windshields, headlight lenses, meter lenses, etc.) and the mufflers. Use only a soft, clean cloth or sponge with water to clean plastic. However, if the plastic parts cannot be thoroughly cleaned with water, diluted mild detergent with water may be used. Be sure to rinse

SCOOTER CARE AND STORAGE

off any detergent residue using plenty of water, as it is harmful to plastic parts.

- Do not use any harsh chemical products on plastic parts. Be sure to avoid using cloths or sponges which have been in contact with strong or abrasive cleaning products, solvent or thinner, fuel (gasoline), rust removers or inhibitors, brake fluid, antifreeze or electrolyte.
- Do not use high-pressure washers or steam-jet cleaners since they cause water seepage and deterioration in the following areas: seals (of wheel and swing-arm bearings, fork and brakes), electric components (couplers, connectors, instruments, switches and lights), breather hoses and vents.
- For scooters equipped with a windshield: Do not use strong cleaners or hard sponges as they will cause dulling or scratching. Some cleaning compounds for plastic may leave scratches on the windshield.

Test the product on a small hidden part of the windshield to make sure that it does not leave any marks. If the windshield is scratched, use a quality plastic polishing compound after washing.

After normal use

Remove dirt with warm water, a mild detergent, and a soft, clean sponge, and then rinse thoroughly with clean water. Use a toothbrush or bottlebrush for hard-to-reach areas. Stubborn dirt and insects will come off more easily if the area is covered with a wet cloth for a few minutes before cleaning.

After riding in the rain, near the sea or on salt-sprayed roads

Since sea salt or salt sprayed on the roads during winter are extremely corrosive in combination with water, carry out the following steps after each ride in the rain, near the sea or on salt-sprayed roads.

TIP

Salt sprayed on roads in the winter may remain well into spring.

1. Clean the scooter with cold water and a mild detergent after the engine has cooled down. **NOTICE: Do not use warm water since it increases the corrosive action of the salt.** [ECA10791]
2. Apply a corrosion protection spray on all metal, including chrome- and nickel-plated, surfaces to prevent corrosion.

Cleaning the windshield

Avoid using any alkaline or strong acid cleaner, gasoline, brake fluid, or any other solvent. Clean the windshield with a cloth or sponge dampened with a mild detergent, and then wash it off thoroughly with water. For additional cleaning, use Yamaha Windshield Cleaner or another high-quality windshield cleaner. Some cleaning compounds for plastics may leave scratches on the windshield. Before using such clean-

SCOOTER CARE AND STORAGE

ers, test an area of the windshield which does not affect your visibility and which cannot be easily recognized.

After cleaning

1. Dry the scooter with a chamois or an absorbing cloth.
2. Use a chrome polish to shine chrome, aluminum and stainless-steel parts, including the exhaust system. (Even the thermally induced discoloring of stainless-steel exhaust systems can be removed through polishing.)
3. To prevent corrosion, it is recommended to apply a corrosion protection spray on all metal, including chrome- and nickel-plated, surfaces.
4. Use spray oil as a universal cleaner to remove any remaining dirt.
5. Touch up minor paint damage caused by stones, etc.
6. Wax all painted surfaces.
7. Let the scooter dry completely before storing or covering it.

WARNING

EWA10942

Contaminants on the brakes or tires can cause loss of control.

- **Make sure that there is no oil or wax on the brakes or tires. If necessary, clean the brake discs and brake linings with a regular brake disc cleaner or acetone, and wash the tires with warm water and a mild detergent.**
- **Before operating the scooter test its braking performance and cornering behavior.**

ECA10800

NOTICE

- **Apply spray oil and wax sparingly and make sure to wipe off any excess.**
- **Never apply oil or wax to any rubber and plastic parts, but treat them with a suitable care product.**
- **Avoid using abrasive polishing compounds as they will wear away the paint.**

TIP

- Consult a Yamaha dealer for advice on what products to use.
- Washing, rainy weather or humid climates can cause the headlight lens to fog. Turning the headlight on for a short period of time will help remove the moisture from the lens.

SCOOTER CARE AND STORAGE

Storage

EAU36563

Short-term

Always store your scooter in a cool, dry place and, if necessary, protect it against dust with a porous cover. Be sure the engine and the exhaust system are cool before covering the scooter.

ECA10820

NOTICE

- **Storing the scooter in a poorly ventilated room or covering it with a tarp, while it is still wet, will allow water and humidity to seep in and cause rust.**
 - **To prevent corrosion, avoid damp cellars, stables (because of the presence of ammonia) and areas where strong chemicals are stored.**
-

Long-term

Before storing your scooter for several months:

1. Follow all the instructions in the “Care” section of this chapter.

2. Fill up the fuel tank and add fuel stabilizer (if available) to prevent the fuel tank from rusting and the fuel from deteriorating.
3. Perform the following steps to protect the cylinder, piston rings, etc. from corrosion.
 - a. Remove the spark plug cap and spark plug.
 - b. Pour a teaspoonful of engine oil into the spark plug bore.
 - c. Install the spark plug cap onto the spark plug, and then place the spark plug on the cylinder head so that the electrodes are grounded. (This will limit sparking during the next step.)
 - d. Turn the engine over several times with the starter. (This will coat the cylinder wall with oil.)
 - e. Remove the spark plug cap from the spark plug, and then install the spark plug and the spark plug cap. **WARNING! To prevent damage or injury from sparking, make sure to ground the spark plug electrodes while turning the engine over.** [EWA10951]
4. Lubricate all control cables and the pivoting points of all levers and pedals as well as of the side-stand/centerstand.
5. Check and, if necessary, correct the tire air pressure, and then lift the scooter so that both of its wheels are off the ground. Alternatively, turn the wheels a little every month in order to prevent the tires from becoming degraded in one spot.
6. Cover the muffler outlet with a plastic bag to prevent moisture from entering it.
7. Remove the battery and fully charge it. Store it in a cool, dry place and charge it once a month. Do not store the battery in an excessively cold or warm place [less than 0 °C (30 °F) or more than 30 °C (90 °F)]. For more information on storing the battery, see page 6-23.

TIP

Make any necessary repairs before storing the scooter.

Dimensions:

- Overall length:
1835 mm (72.2 in)
- Overall width:
685 mm (27.0 in)
- Overall height:
1080 mm (42.5 in)
- Seat height:
755 mm (29.7 in)
- Wheelbase:
1250 mm (49.2 in)
- Ground clearance:
115 mm (4.53 in)
- Minimum turning radius:
1800 mm (70.9 in)

Weight:

- Curb weight:
98 kg (216 lb)

Engine:

- Engine type:
Air cooled 4-stroke, SOHC
- Cylinder arrangement:
Single cylinder
- Displacement:
114 cm³
- Bore × stroke:
50.0 × 57.9 mm (1.97 × 2.28 in)
- Compression ratio:
9.30 : 1
- Starting system:
Electric starter
- Lubrication system:
Wet sump

Engine oil:

- Type:
SAE 10W-40
- Recommended engine oil grade:
API service SG type or higher, JASO standard MB
- Engine oil quantity:
Periodic oil change:
0.90 L (0.95 US qt, 0.79 Imp.qt)

Final transmission oil:

- Type:
SAE 10W-30 type SE motor oil
- Quantity:
0.10 L (0.11 US qt, 0.09 Imp.qt)

Air filter:

- Air filter element:
Oil-coated paper element

Fuel:

- Recommended fuel:
Regular unleaded gasoline (Gasohol (E10) acceptable)
- Fuel tank capacity:
4.4 L (1.16 US gal, 0.97 Imp.gal)

Fuel injection:

- Throttle body:
ID mark:
52B1 01

Spark plug(s):

- Manufacturer/model:
NGK/CR6HSA
- Spark plug gap:
0.6–0.7 mm (0.024–0.028 in)

Clutch:

- Clutch type:
Dry, centrifugal automatic

Transmission:

- Primary reduction ratio:
1.000
- Final drive:
Gear
- Secondary reduction ratio:
9.400 (47/15 x 39/13)
- Transmission type:
V-belt automatic

Chassis:

- Frame type:
Backbone
- Caster angle:
26.50 °
- Trail:
91 mm (3.6 in)

Front tire:

- Type:
Tubeless
- Size:
90/90-12 44J
- Manufacturer/model:
MAXXIS/M6219

Rear tire:

- Type:
Tubeless
- Size:
90/90-12 54J
- Manufacturer/model:
MAXXIS/M6220

SPECIFICATIONS

Loading:

Maximum load:

156 kg (345 lb)

(Total weight of rider, passenger, cargo and accessories)

Tire air pressure (measured on cold tires):

Loading condition:

0–90 kg (0–198 lb)

Front:

175 kPa (1.75 kgf/cm², 25 psi)

Rear:

200 kPa (2.00 kgf/cm², 29 psi)

Loading condition:

90–156 kg (198–344 lb)

Front:

175 kPa (1.75 kgf/cm², 25 psi)

Rear:

200 kPa (2.00 kgf/cm², 29 psi)

Front wheel:

Wheel type:

Cast wheel

Rim size:

12x2.15

Rear wheel:

Wheel type:

Cast wheel

Rim size:

12x2.15

Front brake:

Type:

Single disc brake

Operation:

Right hand operation

Specified brake fluid:

DOT 3 or 4

Rear brake:

Type:

Drum brake

Operation:

Left hand operation

Front suspension:

Type:

Telescopic fork

Spring/shock absorber type:

Coil spring/oil damper

Wheel travel:

85.0 mm (3.35 in)

Rear suspension:

Type:

Unit swing

Spring/shock absorber type:

Coil spring/oil damper

Wheel travel:

70.0 mm (2.76 in)

Electrical system:

Ignition system:

TCI

Charging system:

AC magneto

Battery:

Model:

YTZ6V

Voltage, capacity:

12 V, 5.0 Ah

Headlight:

Bulb type:

Halogen bulb

Bulb voltage, wattage × quantity:

Headlight:

12 V, 35.0 W/35.0 W × 1

Tail/brake light:

12 V, 5.0 W/21.0 W × 1

Front turn signal light:

12 V, 10.0 W × 2

Rear turn signal light:

12 V, 10.0 W × 2

Auxiliary light:

12 V, 5.0 W × 1

License plate light:

12 V, 5.0 W × 1

Meter lighting:

12 V, 1.7 W × 3

High beam indicator light:

12 V, 1.7 W × 1

Turn signal indicator light:

14 V, 3.0 W × 1

Engine trouble warning light:

14 V, 3.0 W × 1

Fuse:

Fuse:

15.0 A

Identification numbers

EAU48612

Record the vehicle identification number and model label information in the spaces provided below for assistance when ordering spare parts from a Yamaha dealer or for reference in case the vehicle is stolen.

VEHICLE IDENTIFICATION
NUMBER:

MODEL LABEL INFORMATION:

Vehicle identification number

EAU26410

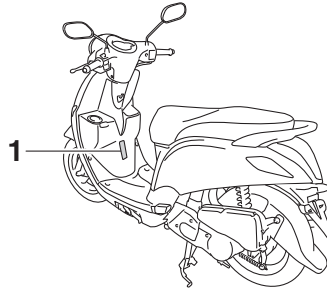

1. Vehicle identification number

The vehicle identification number is stamped into the frame.

TIP _____
The vehicle identification number is used to identify your vehicle and may be used to register it with the licensing authority in your area.

Model label

EAU26500

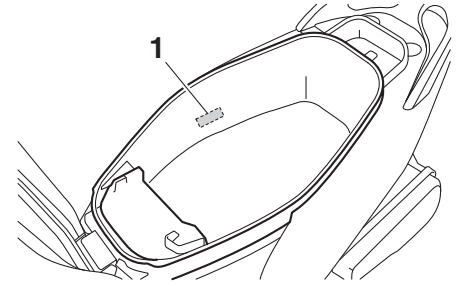

1. Model label

The model label is affixed to the inside of the rear storage compartment. (See page 3-9.) Record the information on this label in the space provided. This information will be needed when ordering spare parts from a Yamaha dealer.

INDEX

- A**
Acceleration and deceleration..... 5-2
Air filter and V-belt case air filter
elements..... 6-13
- B**
Battery..... 6-23
Brake fluid, changing 6-20
Brake fluid level, checking 6-19
Brake lever, front..... 3-4
Brake lever, rear 3-4
Brake levers, lubricating..... 6-21
Brake pads and shoes, checking..... 6-18
Braking..... 5-3
- C**
Cables, checking and lubricating 6-20
Care 7-1
Catalytic converter..... 3-6
Centerstand and sidestand, checking
and lubricating 6-21
Cowling and panels, removing and
installing..... 6-7
- D**
Dimmer switch 3-4
- E**
Engine break-in..... 5-3
Engine oil and oil strainer..... 6-10
Engine trouble warning light..... 3-3
- F**
Final transmission oil 6-12
Front brake lever free play, checking... 6-17
Front fork, checking 6-22
Fuel..... 3-5
Fuel consumption, tips for reducing 5-3
Fuel tank cap 3-5
- Fuse, replacing..... 6-25
- H**
Handlebar switches 3-3
Headlight bulb, replacing..... 6-26
Helmet holders 3-8
High beam indicator light..... 3-2
Horn switch..... 3-4
- I**
Identification numbers 9-1
Ignition circuit cut-off system 3-11
Indicator lights and warning light 3-2
- K**
Keyhole cover..... 3-2
- L**
Luggage hook..... 3-10
- M**
Main switch/steering lock..... 3-1
Maintenance and lubrication, periodic... 6-4
Maintenance, emission control system... 6-3
Matte color, caution 7-1
Model label 9-1
- P**
Parking 5-4
Part locations..... 2-1
- R**
Rear brake lever free play, adjusting.... 6-18
- S**
Safe-riding points..... 1-5
Safety information..... 1-1
Seat 3-7
Sidestand..... 3-10
Spark plug, checking 6-8
Specifications 8-1
Speedometer unit 3-3
- Starting off..... 5-2
Starting the engine 5-1
Start switch..... 3-4
Steering, checking..... 6-23
Storage..... 7-4
Storage compartments..... 3-9
- T**
Tail/brake light bulb or rear turn signal
light bulb, replacing..... 6-27
Throttle grip and cable, checking and
lubricating 6-20
Throttle grip free play, adjusting..... 6-15
Tires 6-15
Tool kit..... 6-2
Troubleshooting 6-28
Troubleshooting chart 6-30
Turn signal indicator light 3-2
Turn signal light bulb (front),
replacing 6-28
Turn signal switch 3-4
- V**
Valve clearance..... 6-15
Vehicle identification number 9-1
- W**
Wheel bearings, checking 6-23
Wheels 6-17

