



 Read this manual carefully before operating this vehicle.

**OWNER'S MANUAL**

**WR250X**

**WR250X**

**32D-28199-E9**

 **Read this manual carefully before operating this vehicle. This manual should stay with this vehicle if it is sold.**

Welcome to the Yamaha world of motorcycling!

As the owner of the WR250X, you are benefiting from Yamaha's vast experience and newest technology regarding the design and manufacture of high-quality products, which have earned Yamaha a reputation for dependability.

Please take the time to read this manual thoroughly, so as to enjoy all advantages of your WR250X. The Owner's Manual does not only instruct you in how to operate, inspect and maintain your motorcycle, but also in how to safeguard yourself and others from trouble and injury.

In addition, the many tips given in this manual will help keep your motorcycle in the best possible condition. If you have any further questions, do not hesitate to contact your Yamaha dealer.

The Yamaha team wishes you many safe and pleasant rides. So, remember to put safety first!

Yamaha continually seeks advancements in product design and quality. Therefore, while this manual contains the most current product information available at the time of printing, there may be minor discrepancies between your motorcycle and this manual. If there is any question concerning this manual, please consult a Yamaha dealer.



---

**Please read this manual carefully and completely before operating this motorcycle.**



---

# IMPORTANT MANUAL INFORMATION

---

EAU10132

Particularly important information is distinguished in this manual by the following notations:

	<b>This is the safety alert symbol. It is used to alert you to potential personal injury hazards. Obey all safety messages that follow this symbol to avoid possible injury or death.</b>
	<b>A WARNING indicates a hazardous situation which, if not avoided, could result in death or serious injury.</b>
<b>NOTICE</b>	<b>A NOTICE indicates special precautions that must be taken to avoid damage to the vehicle or other property.</b>
<b>TIP</b>	A TIP provides key information to make procedures easier or clearer.

# **IMPORTANT MANUAL INFORMATION**

---

EAU10200

**WR250X  
OWNER'S MANUAL  
©2011 by Yamaha Motor Co., Ltd.  
1st edition, June 2011  
All rights reserved.  
Any reprinting or unauthorized use  
without the written permission of  
Yamaha Motor Co., Ltd.  
is expressly prohibited.  
Printed in Japan.**

# TABLE OF CONTENTS

---

<b>SAFETY INFORMATION</b> .....	1-1	<b>FOR YOUR SAFETY – PRE-OPERATION CHECKS</b> .....	4-1	Spoke wheels .....	6-22
<b>DESCRIPTION</b> .....	2-1	<b>OPERATION AND IMPORTANT RIDING POINTS</b> .....	5-1	Adjusting the clutch lever free play .....	6-22
Left view .....	2-1	Starting the engine .....	5-1	Adjusting the brake lever free play .....	6-23
Right view .....	2-2	Shifting .....	5-2	Checking the shift pedal .....	6-24
Controls and instruments.....	2-3	Tips for reducing fuel consumption .....	5-3	Brake light switches .....	6-24
<b>INSTRUMENT AND CONTROL FUNCTIONS</b> .....	3-1	Engine break-in .....	5-3	Checking the front and rear brake pads .....	6-25
Main switch/steering lock .....	3-1	Parking .....	5-4	Checking the brake fluid level .....	6-25
Indicator lights and warning lights .....	3-2	<b>PERIODIC MAINTENANCE AND ADJUSTMENT</b> .....	6-1	Changing the brake fluid .....	6-26
Multi-function display .....	3-3	Owner's tool kit .....	6-2	Drive chain slack .....	6-27
Handlebar switches .....	3-8	Periodic maintenance chart for the emission control system .....	6-3	Cleaning and lubricating the drive chain .....	6-28
Clutch lever .....	3-9	General maintenance and lubrication chart .....	6-4	Checking and lubricating the cables .....	6-29
Shift pedal .....	3-10	Removing and installing panels .....	6-8	Checking and lubricating the throttle grip and cable .....	6-29
Brake lever .....	3-10	Checking the spark plug .....	6-11	Checking and lubricating the brake and clutch levers .....	6-29
Brake pedal .....	3-10	Engine oil and oil filter element .....	6-12	Checking and lubricating the brake pedal .....	6-30
Fuel tank cap .....	3-11	Coolant .....	6-14	Checking and lubricating the sidestand .....	6-30
Fuel .....	3-11	Cleaning the air filter element and check hose .....	6-17	Lubricating the swingarm pivots .....	6-31
Catalytic converter .....	3-13	Adjusting the engine idling speed .....	6-19	Checking the front fork .....	6-31
Seat .....	3-13	Checking the throttle grip free play .....	6-19	Checking the steering .....	6-32
Helmet holder .....	3-14	Valve clearance .....	6-20	Checking the wheel bearings .....	6-32
Adjusting the front fork .....	3-14	Tires .....	6-20	Battery .....	6-32
Front fork bleeding .....	3-16			Replacing the fuses .....	6-34
Adjusting the shock absorber assembly .....	3-17				
EXUP system .....	3-18				
Sidestand .....	3-19				
Ignition circuit cut-off system .....	3-19				

# TABLE OF CONTENTS

---

Replacing the headlight bulb .....	6-35
Tail/brake light .....	6-36
Replacing a turn signal light bulb .....	6-36
Replacing the license plate light bulb .....	6-37
Replacing an auxiliary light bulb .....	6-38
Supporting the motorcycle .....	6-38
Front wheel .....	6-39
Rear wheel .....	6-40
Troubleshooting .....	6-41
Troubleshooting charts .....	6-43

## **MOTORCYCLE CARE AND**

<b>STORAGE</b> .....	7-1
Matte color caution .....	7-1
Care .....	7-1
Storage .....	7-3

## **SPECIFICATIONS** .....

8-1

## **CONSUMER INFORMATION**.....

9-1

Identification numbers .....	9-1
------------------------------	-----

EAU1031A

1

## Be a Responsible Owner

As the vehicle's owner, you are responsible for the safe and proper operation of your motorcycle.

Motorcycles are single-track vehicles. Their safe use and operation are dependent upon the use of proper riding techniques as well as the expertise of the operator. Every operator should know the following requirements before riding this motorcycle.

He or she should:

- Obtain thorough instructions from a competent source on all aspects of motorcycle operation.
- Observe the warnings and maintenance requirements in this Owner's Manual.
- Obtain qualified training in safe and proper riding techniques.
- Obtain professional technical service as indicated in this Owner's Manual and/or when made necessary by mechanical conditions.

## Safe Riding

Perform the pre-operation checks each time you use the vehicle to make sure it is in safe operating condition. Failure to inspect or maintain the vehicle properly increases the possibility of an accident or equipment damage. See page 4-1 for a list of pre-operation checks.

- This motorcycle is designed to carry the operator and a passenger.
- The failure of motorists to detect and recognize motorcycles in traffic is the predominating cause of automobile/motorcycle accidents. Many accidents have been caused by an automobile driver who did not see the motorcycle. Making yourself conspicuous appears to be very effective in reducing the chance of this type of accident.

### Therefore:

- Wear a brightly colored jacket.
- Use extra caution when you are approaching and passing through intersections, since intersections are the most likely places for motorcycle accidents to occur.
- Ride where other motorists can

see you. Avoid riding in another motorist's blind spot.

- Many accidents involve inexperienced operators. In fact, many operators who have been involved in accidents do not even have a current motorcycle license.
- Make sure that you are qualified and that you only lend your motorcycle to other qualified operators.
- Know your skills and limits. Staying within your limits may help you to avoid an accident.
- We recommend that you practice riding your motorcycle where there is no traffic until you have become thoroughly familiar with the motorcycle and all of its controls.
- Many accidents have been caused by error of the motorcycle operator. A typical error made by the operator is veering wide on a turn due to excessive speed or undercornering (insufficient lean angle for the speed).
- Always obey the speed limit and never travel faster than warrant-





- ed by road and traffic conditions.
- Always signal before turning or changing lanes. Make sure that other motorists can see you.
- The posture of the operator and passenger is important for proper control.
- The operator should keep both hands on the handlebar and both feet on the operator footrests during operation to maintain control of the motorcycle.
- The passenger should always hold onto the operator, the seat strap or grab bar, if equipped, with both hands and keep both feet on the passenger footrests. Never carry a passenger unless he or she can firmly place both feet on the passenger footrests.
- Never ride under the influence of alcohol or other drugs.

## Protective Apparel

The majority of fatalities from motorcycle accidents are the result of head injuries. The use of a safety helmet is the single most critical factor in the prevention or reduction of head injuries.

- Always wear an approved helmet.
- Wear a face shield or goggles. Wind in your unprotected eyes could contribute to an impairment of vision that could delay seeing a hazard.
- The use of a jacket, heavy boots, trousers, gloves, etc., is effective in preventing or reducing abrasions or lacerations.
- Never wear loose-fitting clothes, otherwise they could catch on the control levers, footrests, or wheels and cause injury or an accident.
- Always wear protective clothing that covers your legs, ankles, and feet. The engine or exhaust system become very hot during or after operation and can cause burns.
- A passenger should also observe the above precautions.

## Avoid Carbon Monoxide Poisoning

All engine exhaust contains carbon monoxide, a deadly gas. Breathing carbon monoxide can cause headaches, dizziness, drowsiness, nausea, confusion, and eventually death.

Carbon Monoxide is a colorless, odor-

less, tasteless gas which may be present even if you do not see or smell any engine exhaust. Deadly levels of carbon monoxide can collect rapidly and you can quickly be overcome and unable to save yourself. Also, deadly levels of carbon monoxide can linger for hours or days in enclosed or poorly ventilated areas. If you experience any symptoms of carbon monoxide poisoning, leave the area immediately, get fresh air, and SEEK MEDICAL TREATMENT.

- Do not run engine indoors. Even if you try to ventilate engine exhaust with fans or open windows and doors, carbon monoxide can rapidly reach dangerous levels.
- Do not run engine in poorly ventilated or partially enclosed areas such as barns, garages, or carports.
- Do not run engine outdoors where engine exhaust can be drawn into a building through openings such as windows and doors.

## Loading

Adding accessories or cargo to your

# SAFETY INFORMATION

1

motorcycle can adversely affect stability and handling if the weight distribution of the motorcycle is changed. To avoid the possibility of an accident, use extreme caution when adding cargo or accessories to your motorcycle. Use extra care when riding a motorcycle that has added cargo or accessories. Here, along with the information about accessories below, are some general guidelines to follow if loading cargo to your motorcycle:

The total weight of the operator, passenger, accessories and cargo must not exceed the maximum load limit.

**Operation of an overloaded vehicle could cause an accident.**

**Maximum load:**  
185 kg (408 lb)

When loading within this weight limit, keep the following in mind:

- Cargo and accessory weight should be kept as low and close to the motorcycle as possible. Securely pack your heaviest items as close to the center of the vehicle as possible and make sure to distrib-

ute the weight as evenly as possible on both sides of the motorcycle to minimize imbalance or instability.

- Shifting weights can create a sudden imbalance. Make sure that accessories and cargo are securely attached to the motorcycle before riding. Check accessory mounts and cargo restraints frequently.
- Properly adjust the suspension for your load (suspension-adjustable models only), and check the condition and pressure of your tires.
- Never attach any large or heavy items to the handlebar, front fork, or front fender. These items, including such cargo as sleeping bags, duffel bags, or tents, can create unstable handling or a slow steering response.
- **This vehicle is not designed to pull a trailer or to be attached to a sidecar.**

## **Genuine Yamaha Accessories**

Choosing accessories for your vehicle

is an important decision. Genuine Yamaha accessories, which are available only from a Yamaha dealer, have been designed, tested, and approved by Yamaha for use on your vehicle.

Many companies with no connection to Yamaha manufacture parts and accessories or offer other modifications for Yamaha vehicles. Yamaha is not in a position to test the products that these aftermarket companies produce. Therefore, Yamaha can neither endorse nor recommend the use of accessories not sold by Yamaha or modifications not specifically recommended by Yamaha, even if sold and installed by a Yamaha dealer.

## **Aftermarket Parts, Accessories, and Modifications**

While you may find aftermarket products similar in design and quality to genuine Yamaha accessories, recognize that some aftermarket accessories or modifications are not suitable because of potential safety hazards to you or others. Installing aftermarket products or having other modifications performed to your vehicle that change any



of the vehicle's design or operation characteristics can put you and others at greater risk of serious injury or death. You are responsible for injuries related to changes in the vehicle.

Keep the following guidelines in mind, as well as those provided under "Loading" when mounting accessories.

- Never install accessories or carry cargo that would impair the performance of your motorcycle. Carefully inspect the accessory before using it to make sure that it does not in any way reduce ground clearance or cornering clearance, limit suspension travel, steering travel or control operation, or obscure lights or reflectors.
- Accessories fitted to the handlebar or the front fork area can create instability due to improper weight distribution or aerodynamic changes. If accessories are added to the handlebar or front fork area, they must be as lightweight as possible and should be kept to a minimum.
- Bulky or large accessories may seriously affect the stability of

the motorcycle due to aerodynamic effects. Wind may attempt to lift the motorcycle, or the motorcycle may become unstable in cross winds. These accessories may also cause instability when passing or being passed by large vehicles.

- Certain accessories can displace the operator from his or her normal riding position. This improper position limits the freedom of movement of the operator and may limit control ability, therefore, such accessories are not recommended.
- Use caution when adding electrical accessories. If electrical accessories exceed the capacity of the motorcycle's electrical system, an electric failure could result, which could cause a dangerous loss of lights or engine power.

### Aftermarket Tires and Rims

The tires and rims that came with your motorcycle were designed to match the performance capabilities and to provide the best combination of handling, brak-

ing, and comfort. Other tires, rims, sizes, and combinations may not be appropriate. Refer to page 6-20 for tire specifications and more information on replacing your tires.

### Transporting the Motorcycle

Be sure to observe following instructions before transporting the motorcycle in another vehicle.

- Remove all loose items from the motorcycle.
- Check that the fuel cock (if equipped) is in the "OFF" position and that there are no fuel leaks.
- Point the front wheel straight ahead on the trailer or in the truck bed, and choke it in a rail to prevent movement.
- Shift the transmission in gear (for models with a manual transmission).
- Secure the motorcycle with tie-downs or suitable straps that are attached to solid parts of the motorcycle, such as the frame or upper front fork triple clamp (and not, for example, to rubber-mounted handlebars or turn signals, or



## SAFETY INFORMATION

---

1

parts that could break). Choose the location for the straps carefully so the straps will not rub against painted surfaces during transport.

- The suspension should be compressed somewhat by the tie-downs, if possible, so that the motorcycle will not bounce excessively during transport.

## Left view

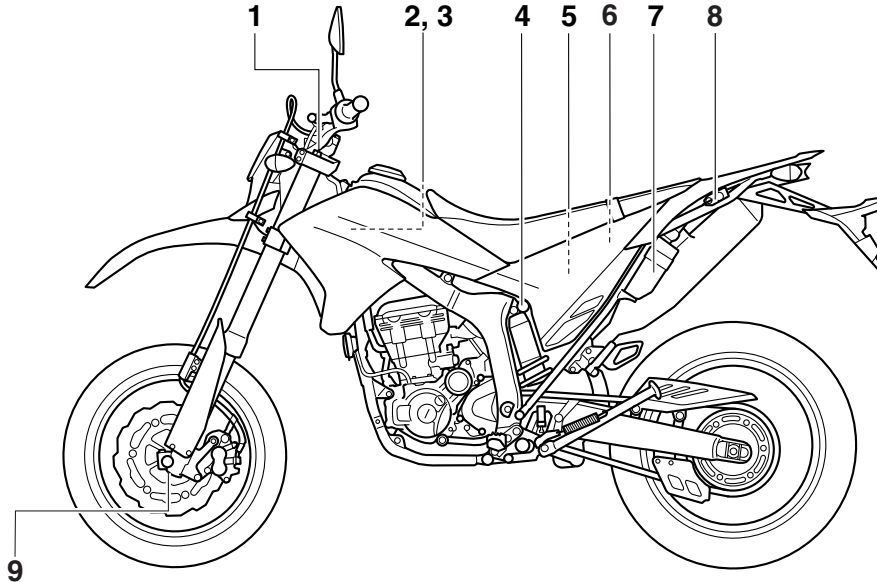

1. Front fork rebound damping force adjusting screw (page 3-14)
2. Fuse box (page 6-34)
3. Coolant reservoir (page 6-14)
4. Shock absorber assembly compression damping force adjusting screw (page 3-17)
5. Battery (page 6-32)
6. Main fuse (page 6-34)
7. Owner's tool kit (page 6-2)
8. Helmet holder (page 3-14)
9. Front fork compression damping force adjusting screw (page 3-14)

# DESCRIPTION

EAU10420

## Right view

2

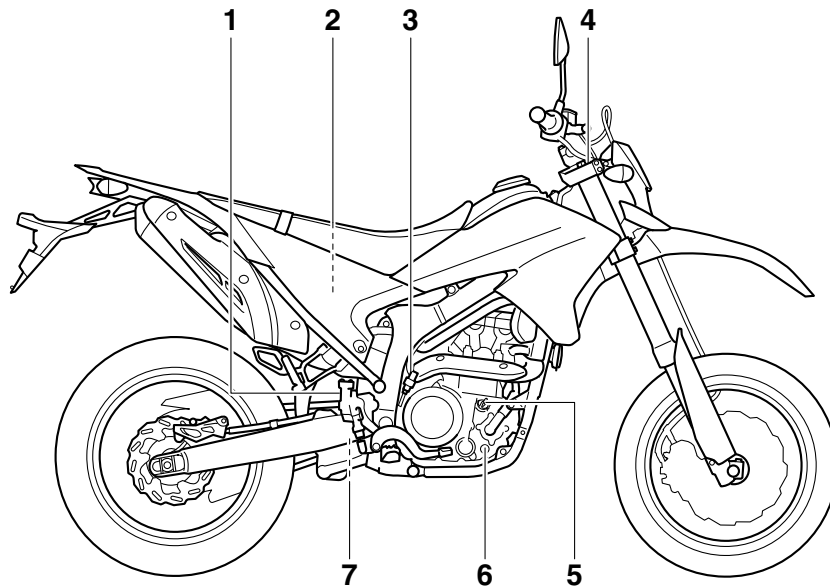

1. Rear brake fluid reservoir (page 6-25)
2. Air filter element (page 6-17)
3. Rear brake light switch (page 6-24)
4. Bleed screw (page 3-16)
5. Engine oil filler cap (page 6-12)
6. Engine oil level check window (page 6-12)
7. Shock absorber assembly rebound damping force adjusting knob (page 3-17)

## Controls and instruments

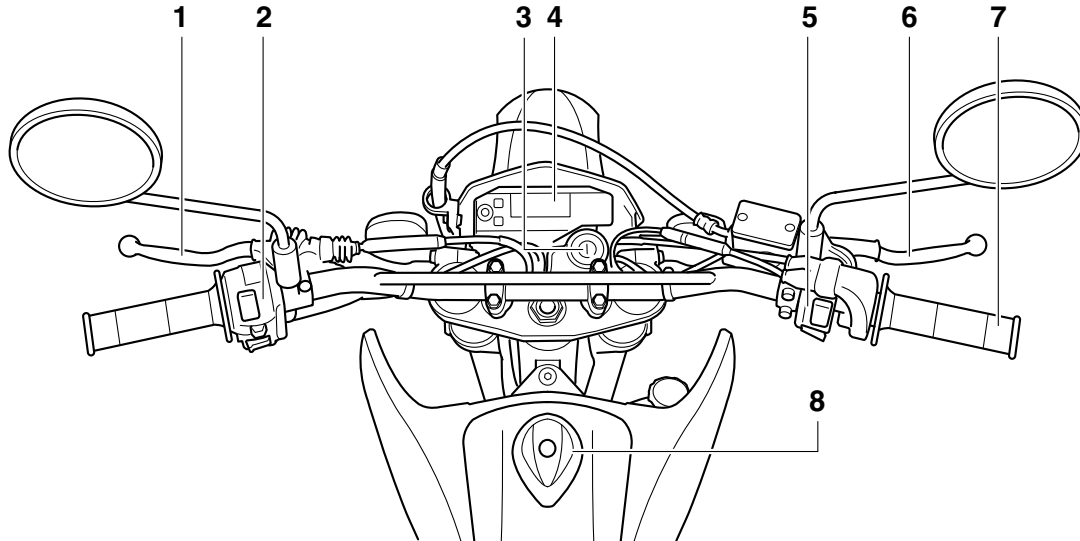

1. Clutch lever (page 3-9)
2. Left handlebar switches (page 3-8)
3. Main switch/steering lock (page 3-1)
4. Multi-function display (page 3-3)
5. Right handlebar switches (page 3-8)
6. Brake lever (page 3-10)
7. Throttle grip (page 6-19)
8. Fuel tank cap (page 3-11)

# INSTRUMENT AND CONTROL FUNCTIONS

## Main switch/steering lock

EAU10460

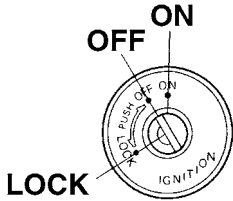

3

The main switch/steering lock controls the ignition and lighting systems, and is used to lock the steering. The various positions are described below.

### ON

EAU38530

All electrical circuits are supplied with power; the meter lighting, taillight, license plate light and auxiliary light come on, and the engine can be started. The key cannot be removed.

### TIP

The headlight comes on automatically when the engine is started and stays on until the key is turned to "OFF", even if the engine stalls.

### OFF

EAU10661

All electrical systems are off. The key can be removed.

EWA10061

### **WARNING**

Never turn the key to "OFF" or "LOCK" while the vehicle is moving. Otherwise the electrical systems will be switched off, which may result in loss of control or an accident.

EAU10683

### LOCK

The steering is locked, and all electrical systems are off. The key can be removed.

## To lock the steering

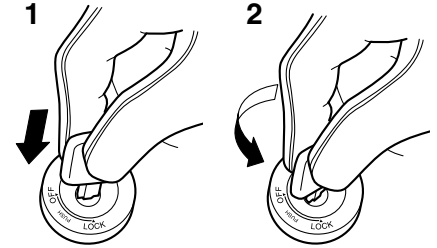

1. Push.
2. Turn.

1. Turn the handlebars all the way to the left.
2. Push the key in from the "OFF" position, and then turn it to "LOCK" while still pushing it.
3. Remove the key.



# INSTRUMENT AND CONTROL FUNCTIONS

## To unlock the steering

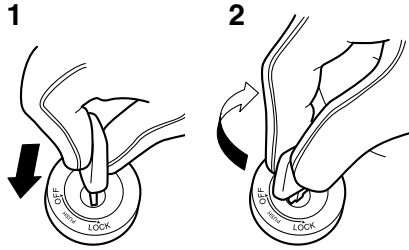





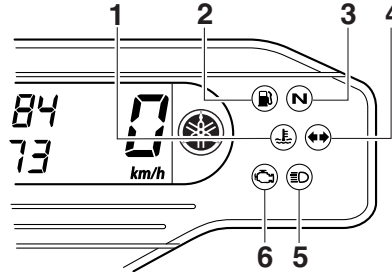

1. Push.
2. Turn.

Push the key in, and then turn it to "OFF" while still pushing it.

## Indicator lights and warning lights

EAU49391



1. Coolant temperature warning light “”
2. Fuel level warning light “”
3. Neutral indicator light “**N**”
4. Turn signal indicator light “”
5. High beam indicator light “”
6. Engine trouble warning light “”

EAU11020

## Turn signal indicator light “”

This indicator light flashes when the turn signal switch is pushed to the left or right.

EAU11060

## Neutral indicator light “**N**”

This indicator light comes on when the transmission is in the neutral position.

EAU11080

## High beam indicator light “”

This indicator light comes on when the high beam of the headlight is switched on.

EAU11352

## Fuel level warning light “”

This warning light comes on when the fuel level drops below approximately 2.1 L (0.55 US gal, 0.46 Imp.gal). When this occurs, refuel as soon as possible. The electrical circuit of the warning light can be checked by turning the key to “ON”. The warning light should come on for a few seconds, and then go off. If the warning light does not come on initially when the key is turned to “ON”, or if the warning light remains on, have a Yamaha dealer check the electrical circuit.

EAU11446

## Coolant temperature warning light “”

This warning light comes on if the engine overheats. If this occurs, stop the engine immediately and allow the engine to cool. The electrical circuit of the warning light

# INSTRUMENT AND CONTROL FUNCTIONS

can be checked by turning the key to “ON”. The warning light should come on for a few seconds, and then go off. If the warning light does not come on initially when the key is turned to “ON”, or if the warning light remains on, have a Yamaha dealer check the electrical circuit.

ECA10021

## NOTICE

**Do not continue to operate the engine if it is overheating.**

## TIP

- For radiator-fan-equipped vehicles, the radiator fan(s) automatically switch on or off according to the coolant temperature in the radiator.
- If the engine overheats, see page 6-44 for further instructions.

EAU11534

## Engine trouble warning light “”

This warning light comes on or flashes if a problem is detected in the electrical circuit monitoring the engine. If this occurs, have a Yamaha dealer check the self-diagnosis system. (See page 3-8

for an explanation of the self-diagnosis device.)

The electrical circuit of the warning light can be checked by turning the key to “ON”. The warning light should come on for a few seconds, and then go off. If the warning light does not come on initially when the key is turned to “ON”, or if the warning light remains on, have a Yamaha dealer check the electrical circuit.

EAU45276

## Multi-function display

EWA12312

### WARNING

**Be sure to stop the vehicle before making any setting changes to the multi-function display. Changing settings while riding can distract the operator and increase the risk of an accident.**

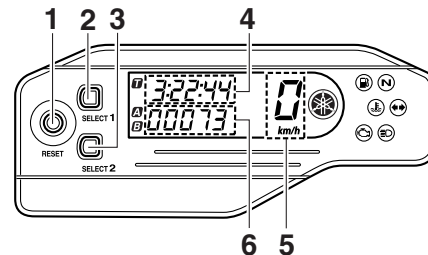

1. “RESET” button
2. “SELECT 1” button
3. “SELECT 2” button
4. Clock/stopwatch
5. Speedometer
6. Odometer/tripmeter/fuel reserve tripmeter

# INSTRUMENT AND CONTROL FUNCTIONS

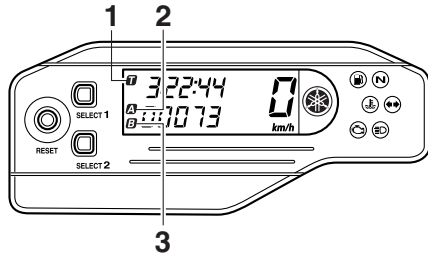

1. Stopwatch indicator “**T**”
2. Tripmeter A indicator “**A**”/Distance-compensation tripmeter “**A**”
3. Tripmeter B indicator “**B**”

## TIP

- The multi-function display can be set to the basic mode or the measurement mode.
- Tripmeter A will automatically reset to zero when changing from the basic mode to the measurement mode or vice versa.

## Basic mode:

- a speedometer
- an odometer
- two tripmeters (which show the distance traveled since they were

last set to zero)

- a fuel reserve tripmeter (which shows the distance traveled since the fuel level warning light came on)
- a clock
- a self-diagnosis device

## Measurement mode:

- a speedometer
- a distance-compensation tripmeter (which shows the accumulated distance traveled since set to zero and which can be calibrated to provide a more accurate tripmeter reading)
- a stopwatch (which shows the time that has been accumulated since the start of stopwatch measurement)
- a self-diagnosis device

## TIP

- Be sure to turn the key to “ON” before using the “SELECT 1”, “SELECT 2” and “RESET” buttons.
- When the key is turned to “ON”, all of the display segments of the multi-function display will appear

and then disappear, in order to test the electrical circuit.

- For the U.K. only: To switch the speedometer and odometer/tripmeter displays between kilometers and miles, press the “SELECT 2” button until the display changes after the key is turned to “ON”.

## Basic mode

### Odometer and tripmeter modes

Push the “SELECT 2” button to switch the display between the odometer mode and the tripmeter modes A and B in the following order:  
odometer → tripmeter A → tripmeter B  
→ odometer

# INSTRUMENT AND CONTROL FUNCTIONS

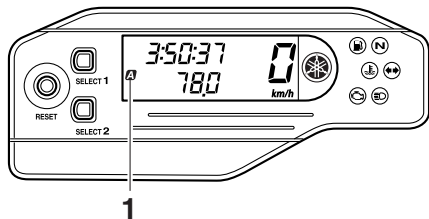

1. Tripmeter A indicator “A”

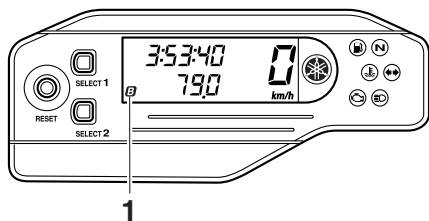

1. Tripmeter B indicator “B”

**TIP** Indicator “A” comes on when tripmeter A is selected, and indicator “B” comes on when tripmeter B is selected.

If the fuel level warning light comes on

(see page 3-2), the display will automatically change to the fuel reserve tripmeter mode “F” and start counting the distance traveled from that point. In this case, push the “SELECT 2” button to switch the display between the various tripmeter and odometer modes in the following order:

fuel reserve tripmeter “F” → odometer → tripmeter A → tripmeter B → fuel reserve tripmeter “F”

## TIP

The fuel level warning light may not function accurately while riding off road as the fuel level reading changes due to the movement and inclination of the vehicle.

If the fuel level warning light comes on while riding in the measurement mode, change to the basic mode and push the “SELECT 2” button to display the fuel reserve tripmeter.

## TIP

To change from the measurement mode to the basic mode, the stopwatch and the distance-compensation tripmeter must be stopped.

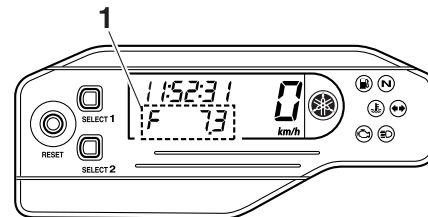

1. Fuel reserve tripmeter “F”

To reset a tripmeter, select it by pushing the “SELECT 2” button, and then push the “RESET” button for at least one second. If you do not reset the fuel reserve tripmeter manually, it will reset itself automatically and the display will return to the prior mode after refueling and traveling 5 km (3 mi).

## Clock

The clock displays when the key is turned to “ON”.

## To set the clock

1. Push the “SELECT 1” button for at least two seconds.
2. When the hour digits start flashing,

push either select button to set the hours.

3. Push the “RESET” button, and the minute digits will start flashing.
4. Push either select button to set the minutes.
5. Push the “RESET” button, and the second digits will start flashing.
6. Push either select button to set the second digits to zero.
7. Push the “RESET” button for at least two seconds, and then release it to start the clock.

## TIP

- When setting the clock, push the “SELECT 1” button to increase the digits or “SELECT 2” button to decrease the digits. Pushing and holding either button will increase or decrease the digits continuously until the button is released.
- If the “RESET” button is not pushed within 30 seconds, the clock will not be set and will return to the prior time.

## Changing from the basic mode to the measurement mode

With the odometer selected, push the “SELECT 1” button and “SELECT 2” button together for at least two seconds to change to the measurement mode.

## Changing from the measurement mode to the basic mode

### TIP



The stopwatch must be stopped before changing to the basic mode.

1. Check that the stopwatch is not in operation. If the stopwatch is in operation, stop it by pushing the “SELECT 1” button and “SELECT 2” button together.
2. Push the “SELECT 1” button and “SELECT 2” button together for at least two seconds to change to the basic mode.

## Measurement mode (for the stopwatch)

When the measurement mode is selected, the stopwatch is displayed and it can be started manually or automatically.

## Manual start

The manual start is the default setting for the stopwatch. The stopwatch indicator “” and the distance-compensation tripmeter indicator “” will start flashing.

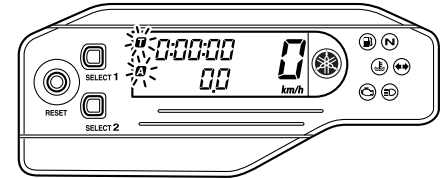

1. Push the “RESET” button to start the stopwatch.
2. Push the “SELECT 1” button and “SELECT 2” button together to stop the stopwatch.
3. To resume stopwatch counting, push the “SELECT 1” button and “SELECT 2” button together. To reset the stopwatch to zero, push the “RESET” button for at least two seconds.

### TIP

The stopwatch will continue counting

# INSTRUMENT AND CONTROL FUNCTIONS

when the vehicle is stopped. To stop and/or resume counting, repeat steps 2 and 3.

## Auto start

1. Push the “SELECT 1” button for at least two seconds to set the auto start.

## TIP

When the stopwatch is set to auto start, the stopwatch indicator “**I**” and the distance-compensation tripmeter indicator “**A**” will start flashing, and the digits in the display will start scrolling from left to right.

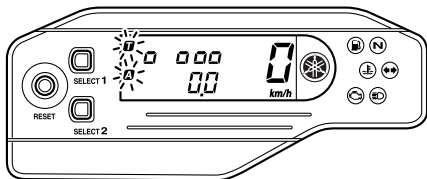

2. When the vehicle starts moving, the stopwatch will start counting.
3. Push the “SELECT 1” button and

“SELECT 2” button together to stop the stopwatch.

4. To resume counting, push the “SELECT 1” button and “SELECT 2” button together again.

## TIP

The stopwatch will continue counting when the vehicle is stopped. To stop and/or resume counting, repeat steps 3 and 4.

## Measurement mode (for calibrating the distance-compensation tripmeter’s reading)

The distance-compensation tripmeter is a feature intended to provide a more accurate tripmeter reading for enduro riding. Calibrating this meter in accordance with the distances specified on the enduro course map will help familiarize the rider with the course. In addition, calibrating the meter may also be necessary when using tire, wheel, chain sprocket sizes, etc. other than specified. For further information concerning the use of this meter, please consult your nearby Yamaha dealer. Calibrate the distance-compensation

tripmeter as follows.

To increase the reading, push the “SELECT 1” button. To decrease the reading, push the “SELECT 2” button. Pushing and holding either button will increase or decrease the reading continuously until the button is released.

## TIP

Calibrating the reading of the distance-compensation tripmeter is possible regardless of the stopwatch operation.

## Resetting the distance-compensation tripmeter or the distance-compensation tripmeter in combination with the stopwatch

## TIP

Resetting can be made only to the distance-compensation tripmeter or to the distance-compensation tripmeter in combination with the stopwatch.

## Resetting the distance-compensation tripmeter

1. Check that the stopwatch measurement is in operation.

# INSTRUMENT AND CONTROL FUNCTIONS

EAU12348

2. Reset the distance-compensation tripmeter to zero by pushing the “RESET” button for at least two seconds.

## Resetting the distance-compensation tripmeter in combination with the stopwatch

1. Stop the stopwatch.
2. Reset the distance-compensation tripmeter and the stopwatch to zero by pushing the “RESET” button for at least two seconds.

## Self-diagnosis device

This model is equipped with a self-diagnosis device for various electrical circuits.

If a problem is detected in any of those circuits, the engine trouble warning light will come on and the display will indicate an error code.

If the display indicates any error codes, note the code number, and then have a Yamaha dealer check the vehicle.

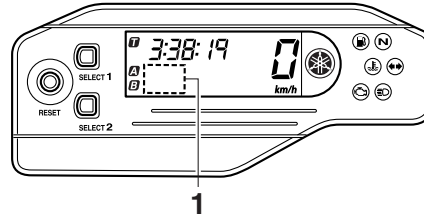

1. Error code display

ECA11590

## **NOTICE**

**If the display indicates an error code, the vehicle should be checked as soon as possible in order to avoid engine damage.**

## Handlebar switches

### Left

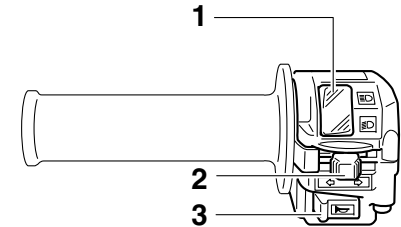

1. Dimmer switch “/”
2. Turn signal switch “/”
3. Horn switch “”

### Right

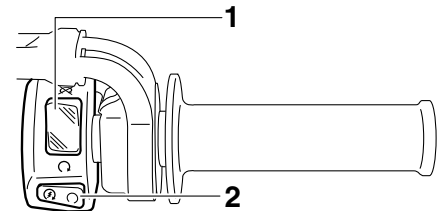



1. Engine stop switch “/”
2. Start switch “”

3

# INSTRUMENT AND CONTROL FUNCTIONS



## Dimmer switch “/”

Set this switch to “” for the high beam and to “” for the low beam.

EAU12400

with the starter. See page 5-1 for starting instructions prior to starting the engine.

## Turn signal switch “/”

To signal a right-hand turn, push this switch to “”. To signal a left-hand turn, push this switch to “”. When released, the switch returns to the center position. To cancel the turn signal lights, push the switch in after it has returned to the center position.

EAU12460



The engine trouble warning light will come on when the key is turned to “ON” and the start switch is pushed, but this does not indicate a malfunction.

## Horn switch “”

Press this switch to sound the horn.

EAU12500

## Engine stop switch “/”

Set this switch to “” before starting the engine. Set this switch to “” to stop the engine in case of an emergency, such as when the vehicle overturns or when the throttle cable is stuck.

EAU12660

## Start switch “”

Push this switch to crank the engine

EAU12711

## Clutch lever

EAU12820

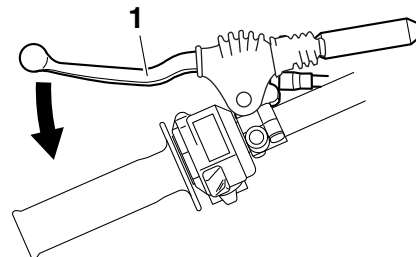

1. Clutch lever

The clutch lever is located at the left handlebar grip. To disengage the clutch, pull the lever toward the handlebar grip. To engage the clutch, release the lever. The lever should be pulled rapidly and released slowly for smooth clutch operation.

The clutch lever is equipped with a clutch switch, which is part of the ignition circuit cut-off system. (See page 3-19.)



# INSTRUMENT AND CONTROL FUNCTIONS

## Shift pedal

EAU12871

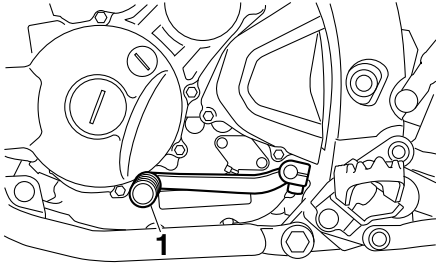

### 1. Shift pedal

The shift pedal is located on the left side of the motorcycle and is used in combination with the clutch lever when shifting the gears of the 6-speed constant-mesh transmission equipped on this motorcycle.

## Brake lever

EAU12890

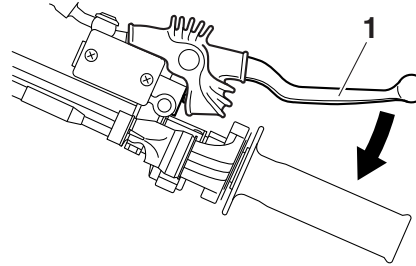

### 1. Brake lever

The brake lever is located at the right handlebar grip. To apply the front brake, pull the lever toward the handlebar grip.

## Brake pedal

EAU12941

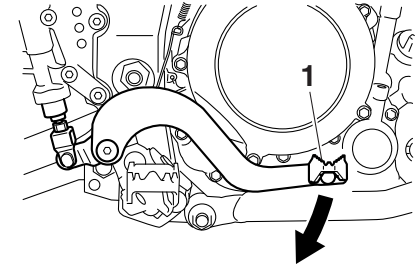

### 1. Brake pedal

The brake pedal is on the right side of the motorcycle. To apply the rear brake, press down on the brake pedal.

# INSTRUMENT AND CONTROL FUNCTIONS

EAU44363

## Fuel tank cap

### To remove the fuel tank cap

1. Insert the key into the lock and turn it counterclockwise as shown.

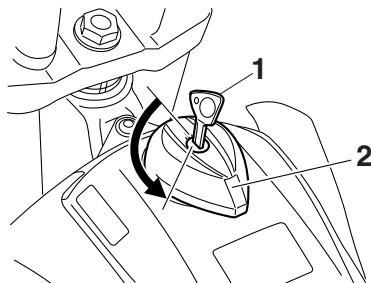

1. Key
2. Fuel tank cap

2. Turn the fuel tank cap counterclockwise and pull it off.

### To install the fuel tank cap

1. Insert the fuel tank cap into the tank opening with the key inserted in the lock, and then turn the cap clockwise.
2. Turn the key clockwise, and then remove it.

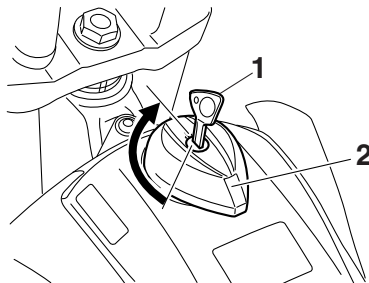

1. Key
2. Fuel tank cap

### TIP

The fuel tank cap cannot be installed unless the key is in the lock. In addition, the key cannot be removed if the cap is not properly installed and locked.

EWA10121

### **WARNING**

**Make sure that the fuel tank cap is properly closed and locked before riding. Leaking fuel is a fire hazard.**

EAU13221

## Fuel

Make sure there is sufficient gasoline in the tank.

EWA10881

### **WARNING**

**Gasoline and gasoline vapors are extremely flammable. To avoid fires and explosions and to reduce the risk of injury when refueling, follow these instructions.**

1. Before refueling, turn off the engine and be sure that no one is sitting on the vehicle. Never refuel while smoking, or while in the vicinity of sparks, open flames, or other sources of ignition such as the pilot lights of water heaters and clothes dryers.
2. Do not overfill the fuel tank. When refueling, be sure to insert the pump nozzle into the fuel tank filler hole. Stop filling when the fuel reaches the bottom of the filler tube. Because fuel expands when it heats up, heat from the engine or the sun can cause fuel to spill out of the fuel tank.

# INSTRUMENT AND CONTROL FUNCTIONS

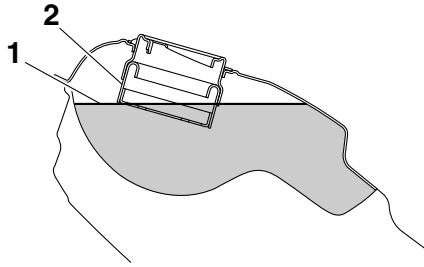

1. Maximum fuel level
2. Fuel tank filler tube
3. Wipe up any spilled fuel immediately. **NOTICE: Immediately wipe off spilled fuel with a clean, dry, soft cloth, since fuel may deteriorate painted surfaces or plastic parts.** [ECA10071]
4. Be sure to securely close the fuel tank cap.

EWA15151

## **WARNING**

Gasoline is poisonous and can cause injury or death. Handle gasoline with care. Never siphon gasoline by mouth. If you should swallow some gasoline or inhale a lot of gasoline vapor, or get some gasoline in

your eyes, see your doctor immediately. If gasoline spills on your skin, wash with soap and water. If gasoline spills on your clothing, change your clothes.

spark plug life and reduce maintenance costs.

EAU13391

### **Recommended fuel:**

Premium unleaded gasoline only

### **Fuel tank capacity:**

8.0 L (2.11 US gal, 1.76 Imp.gal)

### **Fuel reserve amount (when the fuel level warning light comes on):**

2.1 L (0.55 US gal, 0.46 Imp.gal)

ECA11400

## **NOTICE**

**Use only unleaded gasoline. The use of leaded gasoline will cause severe damage to internal engine parts, such as the valves and piston rings, as well as to the exhaust system.**

Your Yamaha engine has been designed to use premium unleaded gasoline with a research octane number of 95 or higher. If knocking (or pinging) occurs, use a gasoline of a different brand. Use of unleaded fuel will extend

# INSTRUMENT AND CONTROL FUNCTIONS

EAU13433

## Catalytic converter

This model is equipped with a catalytic converter in the exhaust system.

EWA10862

### **⚠ WARNING**

The exhaust system is hot after operation. To prevent a fire hazard or burns:

- Do not park the vehicle near possible fire hazards such as grass or other materials that easily burn.
- Park the vehicle in a place where pedestrians or children are not likely to touch the hot exhaust system.
- Make sure that the exhaust system has cooled down before doing any maintenance work.
- Do not allow the engine to idle more than a few minutes. Long idling can cause a build-up of heat.

ECA10701

### **NOTICE**

Use only unleaded gasoline. The use of leaded gasoline will cause unreparable damage to the catalytic

converter.

EAU46281

## Seat

### To remove the seat

Remove the bolts, and then slide the seat to the rear and pull upward.

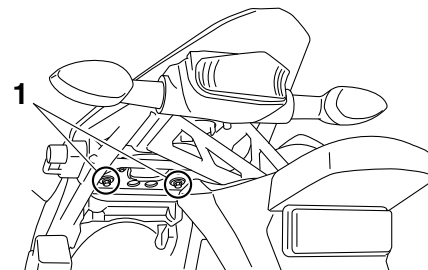

1. Bolt

### To install the seat

1. Fit the slot in the seat onto the projection on the fuel tank, and insert the projection on the seat into the seat holder as shown.

EAU14282

EAU45202

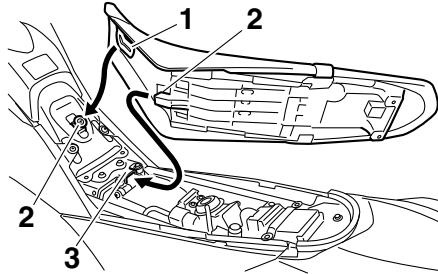

1. Slot
2. Projection
3. Seat holder

2. Place the seat in the original position, and then tighten the bolts.

## TIP

Make sure that the seat is properly secured before riding.

## Helmet holder

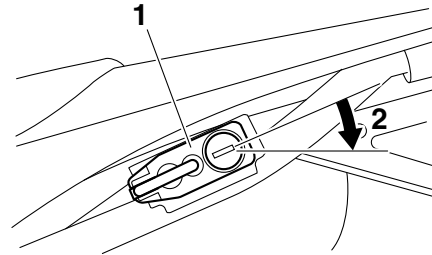

1. Helmet holder
2. Open.

To open the helmet holder, insert the key into the lock, and then turn the key as shown.

To lock the helmet holder, place it in the original position, and then remove the key. **WARNING! Never ride with a helmet attached to the helmet holder, since the helmet may hit objects, causing loss of control and possibly an accident.**<sup>[EWA10161]</sup>

## Adjusting the front fork

EWA10180

### **! WARNING**

**Always adjust both fork legs equally, otherwise poor handling and loss of stability may result.**

This front fork is equipped with rebound damping force adjusting screws and compression damping force adjusting screws.

ECA10101

### **NOTICE**

**To avoid damaging the mechanism, do not attempt to turn beyond the maximum or minimum settings.**

## Rebound damping force

To increase the rebound damping force and thereby harden the rebound damping, turn the adjusting screw on each fork leg in direction (a). To decrease the rebound damping force and thereby soften the rebound damping, turn the adjusting screw on each fork leg in direction (b).

# INSTRUMENT AND CONTROL FUNCTIONS

3

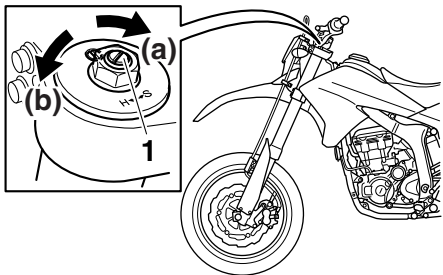

1. Rebound damping force adjusting screw

## Rebound damping setting:

Minimum (soft):

17 click(s) in direction (b)\*

Standard:

10 click(s) in direction (b)\*

Maximum (hard):

1 click(s) in direction (b)\*

\* With the adjusting screw fully turned in direction (a)

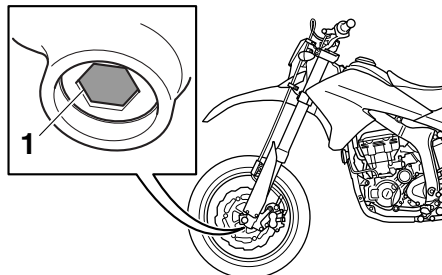

1. Rubber cap

2. To increase the compression damping force and thereby harden the compression damping, turn the adjusting screw on each fork leg in direction (a). To decrease the compression damping force and thereby soften the compression damping, turn the adjusting screw on each fork leg in direction (b).

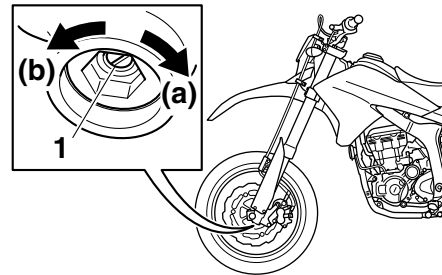

1. Compression damping force adjusting screw

## Compression damping setting:

Minimum (soft):

19 click(s) in direction (b)\*

Standard:

10 click(s) in direction (b)\*

Maximum (hard):

1 click(s) in direction (b)\*

\* With the adjusting screw fully turned in direction (a)

3. Install the rubber cap.

## TIP

Although the total number of clicks of a damping force adjusting mechanism may not exactly match the above specifications due to small differences in production, the actual number of clicks always represents the entire adjusting

range. To obtain a precise adjustment, it would be advisable to check the number of clicks of each damping force adjusting mechanism and to modify the specifications as necessary.

## Front fork bleeding

EAU14793

EWA10200

### **! WARNING**

**Always bleed both fork legs, otherwise poor handling and loss of stability may result.**

When riding in extremely rough conditions, the air temperature and pressure in the front fork will rise. This will increase the spring preload and harden the front suspension. If this occurs, bleed the front fork as follows.

1. Lift the front wheel off the ground according to the procedure on page 6-38.

### **TIP**

When bleeding the front fork, there should be no weight on the front end of the vehicle.

2. Remove the bleed screws and allow all of the air to escape from each fork leg.

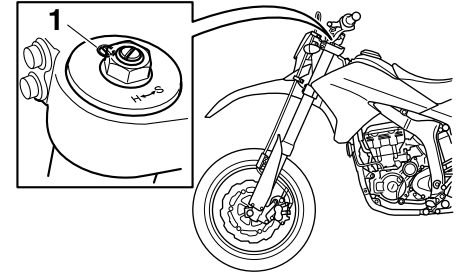

1. Bleed screw

3. Install the bleed screws.
4. Lower the front wheel so that it is on the ground, and then put the sidestand down.

# INSTRUMENT AND CONTROL FUNCTIONS

EAU45263

## Adjusting the shock absorber assembly

This shock absorber assembly is equipped with a spring preload adjusting ring, a rebound damping force adjusting knob and a compression damping force adjusting screw.

ECA10101

### NOTICE

**To avoid damaging the mechanism, do not attempt to turn beyond the maximum or minimum settings.**

### Spring preload

Spring preload adjustment should be made by a Yamaha dealer, since this service requires special tools and technical skills. The specified settings are listed below.

The spring preload setting is determined by measuring distance A, shown in the illustration. The shorter the distance A is, the higher the spring preload; the longer distance A is, the lower the spring preload.

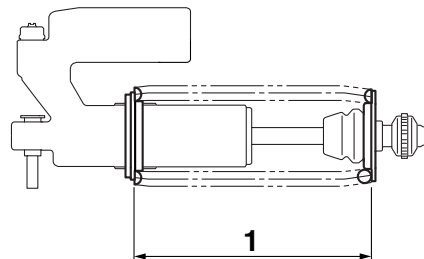

1. Distance A

#### Spring preload:

Minimum (soft):

Distance A = 216.0 mm (8.50 in)

Standard:

Distance A = 211.5 mm (8.33 in)

Maximum (hard):

Distance A = 206.0 mm (8.11 in)

### Rebound damping force

To increase the rebound damping force and thereby harden the rebound damping, turn the adjusting knob in direction (a). To decrease the rebound damping force and thereby soften the rebound damping, turn the adjusting knob in direction (b).

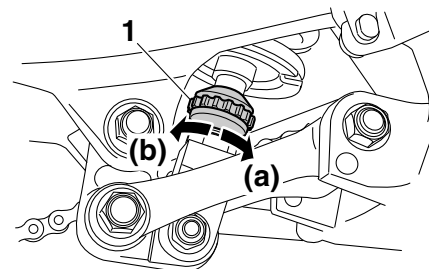

1. Rebound damping force adjusting knob

#### Rebound damping setting:

Minimum (soft):

25 click(s) in direction (b)\*

Standard:

13 click(s) in direction (b)\*

Maximum (hard):

3 click(s) in direction (b)\*

\* With the adjusting knob fully turned in direction (a)

### Compression damping force

To increase the compression damping force and thereby harden the compression damping, turn the adjusting screw in direction (a). To decrease the compression damping force and thereby soften the compression damping, turn the adjusting screw in direction (b).



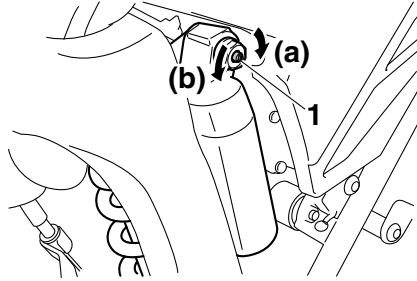

1. Compression damping force adjusting screw

## Compression damping setting:

Minimum (soft):

12 click(s) in direction (b)\*

Standard:

7 click(s) in direction (b)\*

Maximum (hard):

1 click(s) in direction (b)\*

\* With the adjusting screw fully turned in direction (a)

## TIP

To obtain a precise adjustment, it is advisable to check the actual total number of clicks or turns of each damping force adjusting mechanism. This adjustment range may not exactly match the specifications listed due to small differences

in production.

EWA10221

## ⚠ WARNING

This shock absorber assembly contains highly pressurized nitrogen gas. Read and understand the following information before handling the shock absorber assembly.

- Do not tamper with or attempt to open the cylinder assembly.
- Do not subject the shock absorber assembly to an open flame or other high heat source. This may cause the unit to explode due to excessive gas pressure.
- Do not deform or damage the cylinder in any way. Cylinder damage will result in poor damping performance.
- Do not dispose of a damaged or worn-out shock absorber assembly yourself. Take the shock absorber assembly to a Yamaha dealer for any service.

## EXUP system

This model is equipped with Yamaha's EXUP (EXhaust Ultimate Power valve) system. This system boosts engine power by means of a valve that regulates the inner diameter of the exhaust pipe. The EXUP system valve is constantly adjusted in accordance with the engine speed by a computer-controlled servomotor.

3

ECA15610

## NOTICE

The EXUP system has been set and extensively tested at the Yamaha factory. Changing these settings without sufficient technical knowledge may result in poor performance of or damage to the engine.

# INSTRUMENT AND CONTROL FUNCTIONS

## Sidestand

EAU15305

The sidestand is located on the left side of the frame. Raise the sidestand or lower it with your foot while holding the vehicle upright.

### TIP

3

The built-in sidestand switch is part of the ignition circuit cut-off system, which cuts the ignition in certain situations. (See the following section for an explanation of the ignition circuit cut-off system.)

EWA10241

### WARNING

**The vehicle must not be ridden with the sidestand down, or if the sidestand cannot be properly moved up (or does not stay up), otherwise the sidestand could contact the ground and distract the operator, resulting in a possible loss of control. Yamaha's ignition circuit cut-off system has been designed to assist the operator in fulfilling the responsibility of raising the sidestand before starting off. Therefore, check this system regularly and have a**

**Yamaha dealer repair it if it does not function properly.**

EAU44892

## Ignition circuit cut-off system

The ignition circuit cut-off system (comprising the sidestand switch, clutch switch and neutral switch) has the following functions.

- It prevents starting when the transmission is in gear and the sidestand is up, but the clutch lever is not pulled.
- It prevents starting when the transmission is in gear and the clutch lever is pulled, but the sidestand is still down.
- It cuts the running engine when the transmission is in gear and the sidestand is moved down.

Periodically check the operation of the ignition circuit cut-off system according to the following procedure.

# INSTRUMENT AND CONTROL FUNCTIONS

With the engine turned off:

1. Move the sidestand down.
2. Make sure that the engine stop switch is set to “○”.
3. Turn the key on.
4. Shift the transmission into the neutral position.
5. Push the start switch.

**Does the engine start?**

YES NO



**If a malfunction is noted, have a Yamaha dealer check the system before riding.**

The neutral switch may not be working correctly.  
**The motorcycle should not be ridden** until checked by a Yamaha dealer.

With the engine still running:

6. Move the sidestand up.
7. Keep the clutch lever pulled.
8. Shift the transmission into gear.
9. Move the sidestand down.

**Does the engine stall?**

YES NO

The sidestand switch may not be working correctly.  
**The motorcycle should not be ridden** until checked by a Yamaha dealer.

After the engine has stalled:

10. Move the sidestand up.
11. Keep the clutch lever pulled.
12. Push the start switch.

**Does the engine start?**

YES NO

The clutch switch may not be working correctly.  
**The motorcycle should not be ridden** until checked by a Yamaha dealer.

The system is OK. **The motorcycle can be ridden.**

# FOR YOUR SAFETY – PRE-OPERATION CHECKS

EAU15596

Inspect your vehicle each time you use it to make sure the vehicle is in safe operating condition. Always follow the inspection and maintenance procedures and schedules described in the Owner's Manual.

EWA11151

## **WARNING**

**Failure to inspect or maintain the vehicle properly increases the possibility of an accident or equipment damage. Do not operate the vehicle if you find any problem. If a problem cannot be corrected by the procedures provided in this manual, have the vehicle inspected by a Yamaha dealer.**

Before using this vehicle, check the following points:

ITEM	CHECKS	PAGE
<b>Fuel</b>	<ul style="list-style-type: none"><li>• Check fuel level in fuel tank.</li><li>• Refuel if necessary.</li><li>• Check fuel line for leakage.</li></ul>	3-11
<b>Engine oil</b>	<ul style="list-style-type: none"><li>• Check oil level in engine.</li><li>• If necessary, add recommended oil to specified level.</li><li>• Check vehicle for oil leakage.</li></ul>	6-12
<b>Coolant</b>	<ul style="list-style-type: none"><li>• Check coolant level in reservoir.</li><li>• If necessary, add recommended coolant to specified level.</li><li>• Check cooling system for leakage.</li></ul>	6-14
<b>Front brake</b>	<ul style="list-style-type: none"><li>• Check operation.</li><li>• If soft or spongy, have Yamaha dealer bleed hydraulic system.</li><li>• Check lever free play.</li><li>• Adjust if necessary.</li><li>• Check brake pads for wear.</li><li>• Replace if necessary.</li><li>• Check fluid level in reservoir.</li><li>• If necessary, add specified brake fluid to specified level.</li><li>• Check hydraulic system for leakage.</li></ul>	6-23, 6-25

4

# FOR YOUR SAFETY – PRE-OPERATION CHECKS

ITEM	CHECKS	PAGE
<b>Rear brake</b>	<ul style="list-style-type: none"> <li>• Check operation.</li> <li>• If soft or spongy, have Yamaha dealer bleed hydraulic system.</li> <li>• Check brake pads for wear.</li> <li>• Replace if necessary.</li> <li>• Check fluid level in reservoir.</li> <li>• If necessary, add specified brake fluid to specified level.</li> <li>• Check hydraulic system for leakage.</li> </ul>	6-25
<b>Clutch</b>	<ul style="list-style-type: none"> <li>• Check operation.</li> <li>• Lubricate cable if necessary.</li> <li>• Check lever free play.</li> <li>• Adjust if necessary.</li> </ul>	6-22
<b>Throttle grip</b>	<ul style="list-style-type: none"> <li>• Make sure that operation is smooth.</li> <li>• Check throttle grip free play.</li> <li>• If necessary, have Yamaha dealer adjust throttle grip free play and lubricate cable and grip housing.</li> </ul>	6-19, 6-29
<b>Control cables</b>	<ul style="list-style-type: none"> <li>• Make sure that operation is smooth.</li> <li>• Lubricate if necessary.</li> </ul>	6-29
<b>Drive chain</b>	<ul style="list-style-type: none"> <li>• Check chain slack.</li> <li>• Adjust if necessary.</li> <li>• Check chain condition.</li> <li>• Lubricate if necessary.</li> </ul>	6-27, 6-28
<b>Wheels and tires</b>	<ul style="list-style-type: none"> <li>• Check for damage.</li> <li>• Check tire condition and tread depth.</li> <li>• Check air pressure.</li> <li>• Correct if necessary.</li> </ul>	6-20, 6-22
<b>Shift pedal</b>	<ul style="list-style-type: none"> <li>• Make sure that operation is smooth.</li> <li>• Correct if necessary.</li> </ul>	6-24
<b>Brake pedal</b>	<ul style="list-style-type: none"> <li>• Make sure that operation is smooth.</li> <li>• Lubricate pedal pivoting point if necessary.</li> </ul>	6-30
<b>Brake and clutch levers</b>	<ul style="list-style-type: none"> <li>• Make sure that operation is smooth.</li> <li>• Lubricate lever pivoting points if necessary.</li> </ul>	6-29
<b>Sidestand</b>	<ul style="list-style-type: none"> <li>• Make sure that operation is smooth.</li> <li>• Lubricate pivot if necessary.</li> </ul>	6-30

# FOR YOUR SAFETY – PRE-OPERATION CHECKS

ITEM	CHECKS	PAGE
Chassis fasteners	<ul style="list-style-type: none"><li>• Make sure that all nuts, bolts and screws are properly tightened.</li><li>• Tighten if necessary.</li></ul>	—
Instruments, lights, signals and switches	<ul style="list-style-type: none"><li>• Check operation.</li><li>• Correct if necessary.</li></ul>	—
Sidestand switch	<ul style="list-style-type: none"><li>• Check operation of ignition circuit cut-off system.</li><li>• If system is not working correctly, have Yamaha dealer check vehicle.</li></ul>	3-19

# OPERATION AND IMPORTANT RIDING POINTS

EAU15951

EAU46632

EAU45127

Read the Owner's Manual carefully to become familiar with all controls. If there is a control or function you do not understand, ask your Yamaha dealer.

EWA10271



**Failure to familiarize yourself with the controls can lead to loss of control, which could cause an accident or injury.**

## TIP

This model is equipped with:

- a lean angle sensor to stop the engine in case of a turnover. In this case, the multi-function display indicates error code 30, but this is not a malfunction. Turn the key to "OFF" and then to "ON" to clear the error code. Failing to do so will prevent the engine from starting even though the engine will crank when pushing the start switch.
- an engine auto-stop system. The engine stops automatically if left idling for 20 minutes. In this case, the multi-function display indicates error code 70, but this is not a malfunction. Push the start switch to clear the error code and to restart the engine.

## Starting the engine

In order for the ignition circuit cut-off system to enable starting, one of the following conditions must be met:

- The transmission is in the neutral position.
- The transmission is in gear with the clutch lever pulled and the sidestand up.  
See page 3-19 for more information.

1. Turn the key to "ON" and make sure that the engine stop switch is set to "○".

The following warning lights should come on for a few seconds, then go off.

- Fuel level warning light
- Coolant temperature warning light
- Engine trouble warning light

ECA15484

## NOTICE

**If a warning light does not come on initially when the key is turned to "ON", or if a warning light remains on, see page 3-2 for the corresponding warning light circuit check.**

# OPERATION AND IMPORTANT RIDING POINTS

5

2. Shift the transmission into the neutral position. The neutral indicator light should come on. If not, ask a Yamaha dealer to check the electrical circuit.
3. Start the engine by pushing the start switch.  
If the engine fails to start, release the start switch, wait a few seconds, and then try again. Each starting attempt should be as short as possible to preserve the battery. Do not crank the engine more than 10 seconds on any one attempt.

ECA11042

## NOTICE

**For maximum engine life, never accelerate hard when the engine is cold!**

## Shifting

EAU16671

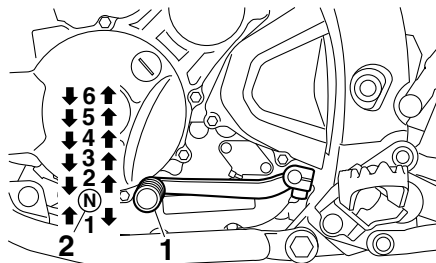

1. Shift pedal
2. Neutral position

Shifting gears lets you control the amount of engine power available for starting off, accelerating, climbing hills, etc.

The gear positions are shown in the illustration.

## TIP

To shift the transmission into the neutral position, press the shift pedal down repeatedly until it reaches the end of its travel, and then slightly raise it.

ECA10260

## NOTICE

- Even with the transmission in

the neutral position, do not coast for long periods of time with the engine off, and do not tow the motorcycle for long distances. The transmission is properly lubricated only when the engine is running. Inadequate lubrication may damage the transmission.

- Always use the clutch while changing gears to avoid damaging the engine, transmission, and drive train, which are not designed to withstand the shock of forced shifting.



# OPERATION AND IMPORTANT RIDING POINTS

## Tips for reducing fuel consumption

EAU16810

Fuel consumption depends largely on your riding style. Consider the following tips to reduce fuel consumption:

- Shift up swiftly, and avoid high engine speeds during acceleration.
- Do not rev the engine while shifting down, and avoid high engine speeds with no load on the engine.
- Turn the engine off instead of letting it idle for an extended length of time (e.g., in traffic jams, at traffic lights or at railroad crossings).

## Engine break-in

EAU16841

There is never a more important period in the life of your engine than the period between 0 and 1600 km (1000 mi). For this reason, you should read the following material carefully.

Since the engine is brand new, do not put an excessive load on it for the first 1600 km (1000 mi). The various parts in the engine wear and polish themselves to the correct operating clearances. During this period, prolonged full-throttle operation or any condition that might result in engine overheating must be avoided.

EAU17023

### 0–1000 km (0–600 mi)

Avoid prolonged operation above 1/3 throttle. **NOTICE: After 1000 km (600 mi) of operation, the engine oil must be changed, and the oil filter cartridge or element replaced.**<sup>[ECA11282]</sup>

### 1000–1600 km (600–1000 mi)

Avoid prolonged operation above 1/2

throttle.

### 1600 km (1000 mi) and beyond

The vehicle can now be operated normally.

ECA10270

#### **NOTICE**

**If any engine trouble should occur during the engine break-in period, immediately have a Yamaha dealer check the vehicle.**

# OPERATION AND IMPORTANT RIDING POINTS

---

EAU17213

## Parking

When parking, stop the engine, and then remove the key from the main switch.

EWA10311

### **WARNING**

- Since the engine and exhaust system can become very hot, park in a place where pedestrians or children are not likely to touch them and be burned.
  - Do not park on a slope or on soft ground, otherwise the vehicle may overturn, increasing the risk of a fuel leak and fire.
  - Do not park near grass or other flammable materials which might catch fire.
-

# PERIODIC MAINTENANCE AND ADJUSTMENT

EAU17244

Periodic inspection, adjustment, and lubrication will keep your vehicle in the safest and most efficient condition possible. Safety is an obligation of the vehicle owner/operator. The most important points of vehicle inspection, adjustment, and lubrication are explained on the following pages.

The intervals given in the periodic maintenance charts should be simply considered as a general guide under normal riding conditions. However, depending on the weather, terrain, geographical location, and individual use, the maintenance intervals may need to be shortened.

EWA10321

## **WARNING**

**Failure to properly maintain the vehicle or performing maintenance activities incorrectly may increase your risk of injury or death during service or while using the vehicle. If you are not familiar with vehicle service, have a Yamaha dealer perform service.**

EWA15122

## **WARNING**

**Turn off the engine when performing maintenance unless otherwise specified.**

- **A running engine has moving parts that can catch on body parts or clothing and electrical parts that can cause shocks or fires.**
- **Running the engine while servicing can lead to eye injury, burns, fire, or carbon monoxide poisoning – possibly leading to death. See page 1-2 for more information about carbon monoxide.**

EWA15460

## **WARNING**

**Brake discs, calipers, drums, and linings can become very hot during use. To avoid possible burns, let brake components cool before touching them.**

EAU17302

Emission controls not only function to ensure cleaner air, but are also vital to proper engine operation and maximum performance. In the following periodic maintenance charts, the services related to emissions control are grouped separately. These services require specialized data, knowledge, and equipment. Maintenance, replacement, or repair of the emission control devices and systems may be performed by any repair establishment or individual that is certified (if applicable). Yamaha dealers are trained and equipped to perform these particular services.

# PERIODIC MAINTENANCE AND ADJUSTMENT

---

EAU35011

## Owner's tool kit

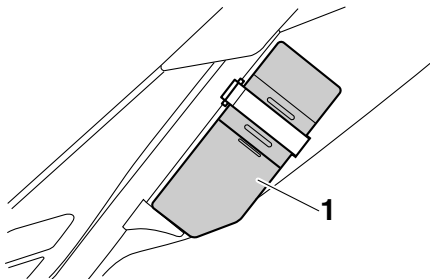

1. Tool box

The owner's tool kit is located inside the tool box.

6

The service information included in this manual and the tools provided in the owner's tool kit are intended to assist you in the performance of preventive maintenance and minor repairs. However, additional tools such as a torque wrench may be necessary to perform certain maintenance work correctly.

### **TIP** \_\_\_\_\_

If you do not have the tools or experience required for a particular job, have a Yamaha dealer perform it for you.

---

# PERIODIC MAINTENANCE AND ADJUSTMENT

EAU46861

## TIP

- The annual checks must be performed every year, except if a kilometer-based maintenance, or for the UK, a mileage-based maintenance, is performed instead.
- From 50000 km (30000 mi), repeat the maintenance intervals starting from 10000 km (6000 mi).
- Items marked with an asterisk should be performed by a Yamaha dealer as they require special tools, data and technical skills.

EAU46910

## Periodic maintenance chart for the emission control system

NO.	ITEM	CHECK OR MAINTENANCE JOB	ODOMETER READING					ANNUAL CHECK
			1000 km (600 mi)	10000 km (6000 mi)	20000 km (12000 mi)	30000 km (18000 mi)	40000 km (24000 mi)	
1	* Fuel line	<ul style="list-style-type: none"> <li>• Check fuel hoses for cracks or damage.</li> </ul>		√	√	√	√	√
2	* Spark plug	<ul style="list-style-type: none"> <li>• Check condition.</li> <li>• Clean and regap.</li> </ul>		√		√		
		<ul style="list-style-type: none"> <li>• Replace.</li> </ul>			√		√	
3	* Valves	<ul style="list-style-type: none"> <li>• Check valve clearance.</li> <li>• Adjust.</li> </ul>	Every 40000 km (24000 mi)					
4	* Fuel injection	<ul style="list-style-type: none"> <li>• Adjust engine idling speed.</li> </ul>	√	√	√	√	√	√
5	* Muffler and exhaust pipe	<ul style="list-style-type: none"> <li>• Check the screw clamp(s) for looseness.</li> </ul>	√	√	√	√	√	
6	* Air induction system	<ul style="list-style-type: none"> <li>• Check the air cut-off valve, reed valve, and hose for damage.</li> <li>• Replace any damaged parts if necessary.</li> </ul>		√	√	√	√	√

# PERIODIC MAINTENANCE AND ADJUSTMENT

EAU1770C

## General maintenance and lubrication chart

NO.	ITEM	CHECK OR MAINTENANCE JOB	ODOMETER READING					ANNUAL CHECK
			1000 km (600 mi)	10000 km (6000 mi)	20000 km (12000 mi)	30000 km (18000 mi)	40000 km (24000 mi)	
1	Air filter element	• Clean.		√		√		
		• Replace.			√		√	
2	Clutch	• Check operation. • Adjust.	√	√	√	√	√	
3 *	Front brake	• Check operation, fluid level and vehicle for fluid leakage. • Adjust brake lever free play.	√	√	√	√	√	√
		• Replace brake pads.	Whenever worn to the limit					
4 *	Rear brake	• Check operation, fluid level and vehicle for fluid leakage.	√	√	√	√	√	√
		• Replace brake pads.	Whenever worn to the limit					
5 *	Brake hoses	• Check for cracks or damage. • Check for correct routing and clamping.		√	√	√	√	√
		• Replace.	Every 4 years					
6 *	Wheels	• Check runout, spoke tightness and for damage. • Tighten spokes if necessary.	√	√	√	√	√	
7 *	Tires	• Check tread depth and for damage. • Replace if necessary. • Check air pressure. • Correct if necessary.		√	√	√	√	√
8 *	Wheel bearings	• Check bearing for looseness or damage.		√	√	√	√	

6

# PERIODIC MAINTENANCE AND ADJUSTMENT

NO.	ITEM	CHECK OR MAINTENANCE JOB	ODOMETER READING					ANNUAL CHECK
			1000 km (600 mi)	10000 km (6000 mi)	20000 km (12000 mi)	30000 km (18000 mi)	40000 km (24000 mi)	
9	*	<b>Swingarm</b>	<ul style="list-style-type: none"> <li>• Check operation and for excessive play.</li> </ul>	√	√	√	√	
			<ul style="list-style-type: none"> <li>• Lubricate with lithium-soap-based grease.</li> </ul>	Every 50000 km (30000 mi)				
10		<b>Drive chain</b>	<ul style="list-style-type: none"> <li>• Check chain slack, alignment and condition.</li> <li>• Adjust and lubricate chain with a special O-ring chain lubricant thoroughly.</li> </ul>	Every 500 km (300 mi) and after washing the motorcycle, riding in the rain or riding in wet areas				
11	*	<b>Steering bearings</b>	<ul style="list-style-type: none"> <li>• Check bearing play and steering for roughness.</li> </ul>	√	√	√	√	√
			<ul style="list-style-type: none"> <li>• Lubricate with lithium-soap-based grease.</li> </ul>	Every 50000 km (30000 mi)				
12	*	<b>Chassis fasteners</b>	<ul style="list-style-type: none"> <li>• Make sure that all nuts, bolts and screws are properly tightened.</li> </ul>	√	√	√	√	√
13		<b>Brake lever pivot shaft</b>	<ul style="list-style-type: none"> <li>• Lubricate with silicone grease.</li> </ul>	√	√	√	√	√
14		<b>Brake pedal pivot shaft</b>	<ul style="list-style-type: none"> <li>• Lubricate with lithium-soap-based grease.</li> </ul>	√	√	√	√	√
15		<b>Clutch lever pivot shaft</b>	<ul style="list-style-type: none"> <li>• Lubricate with lithium-soap-based grease.</li> </ul>	√	√	√	√	√
16		<b>Sidestand</b>	<ul style="list-style-type: none"> <li>• Check operation.</li> <li>• Lubricate with lithium-soap-based grease.</li> </ul>	√	√	√	√	√
17	*	<b>Sidestand switch</b>	<ul style="list-style-type: none"> <li>• Check operation.</li> </ul>	√	√	√	√	√
18	*	<b>Front fork</b>	<ul style="list-style-type: none"> <li>• Check operation and for oil leakage.</li> </ul>	√	√	√	√	
19	*	<b>Shock absorber assembly</b>	<ul style="list-style-type: none"> <li>• Check operation and shock absorber for oil leakage.</li> </ul>	√	√	√	√	

# PERIODIC MAINTENANCE AND ADJUSTMENT

NO.	ITEM	CHECK OR MAINTENANCE JOB	ODOMETER READING					ANNUAL CHECK
			1000 km (600 mi)	10000 km (6000 mi)	20000 km (12000 mi)	30000 km (18000 mi)	40000 km (24000 mi)	
20	* Rear suspension relay arm and connecting arm pivoting points	<ul style="list-style-type: none"> <li>Check operation.</li> </ul>		√	√	√	√	
21	Engine oil	<ul style="list-style-type: none"> <li>Change.</li> <li>Check oil level and vehicle for oil leakage.</li> </ul>	√	Every 5000 km (3000 mi)				√
22	Engine oil filter element	<ul style="list-style-type: none"> <li>Replace.</li> </ul>	√	√	√	√	√	
23	* Cooling system	<ul style="list-style-type: none"> <li>Check coolant level and vehicle for coolant leakage.</li> <li>Change with ethylene glycol anti-freeze coolant.</li> </ul>		√	√	√	√	√
24	* Front and rear brake switches	<ul style="list-style-type: none"> <li>Check operation.</li> </ul>	√	√	√	√	√	√
25	Moving parts and cables	<ul style="list-style-type: none"> <li>Lubricate.</li> </ul>		√	√	√	√	√
26	* Throttle grip	<ul style="list-style-type: none"> <li>Check operation.</li> <li>Check throttle grip free play, and adjust if necessary.</li> <li>Lubricate cable and grip housing.</li> </ul>		√	√	√	√	√
27	* Lights, signals and switches	<ul style="list-style-type: none"> <li>Check operation.</li> <li>Adjust headlight beam.</li> </ul>	√	√	√	√	√	√



# PERIODIC MAINTENANCE AND ADJUSTMENT

---

EAU18670

## TIP

---

- The air filter needs more frequent service if you are riding in unusually wet or dusty areas.
  - Hydraulic brake service
    - Regularly check and, if necessary, correct the brake fluid level.
    - Every two years replace the internal components of the brake master cylinders and calipers, and change the brake fluid.
    - Replace the brake hoses every four years and if cracked or damaged.
-

# PERIODIC MAINTENANCE AND ADJUSTMENT

EAU18771

EAU45131

## Removing and installing panels

The panels shown need to be removed to perform some of the maintenance jobs described in this chapter. Refer to this section each time a panel needs to be removed and installed.

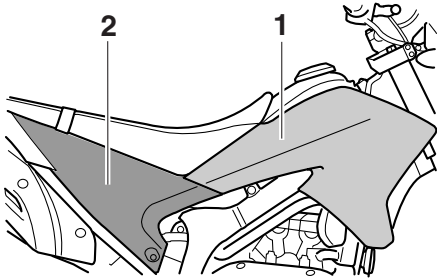

1. Panel A
2. Panel B

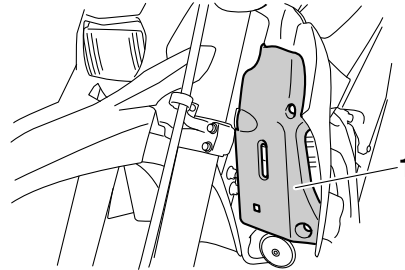

1. Panel C

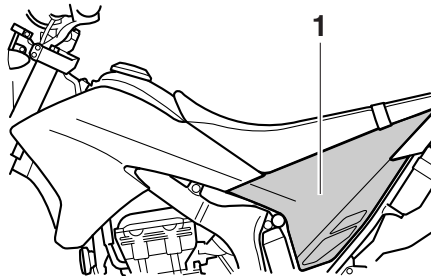

1. Panel D

## Panel A

### To remove the panel

1. Remove the seat. (See page 3-13.)
2. Remove the bolts and collars.

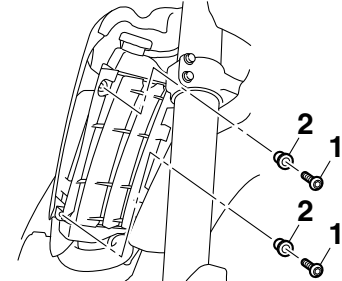

1. Bolt
2. Collar

# PERIODIC MAINTENANCE AND ADJUSTMENT

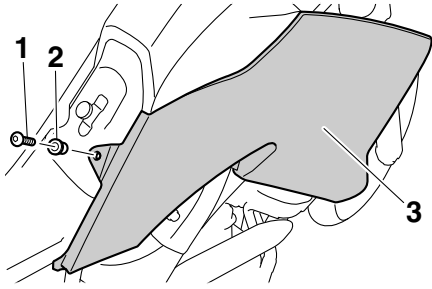

1. Bolt
2. Collar
3. Panel A

3. Pull the front part of the panel outward, and then remove the panel by pulling it off.

## To install the panel

1. Place the panel in the original position, and then install the collars and bolts.

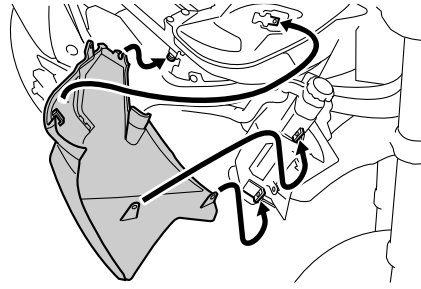

2. Install the seat.

## **Panel B**

### To remove the panel

1. Remove the seat. (See page 3-13.)
2. Remove the bolt, and then remove the panel as shown.

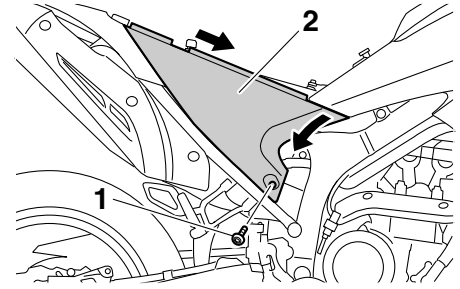

1. Bolt
2. Panel B

### To install the panel

1. Place the panel in the original position, and then install the bolt.

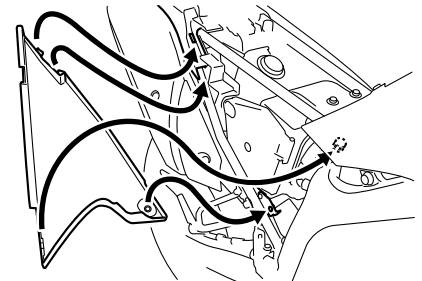

2. Install the seat.

# PERIODIC MAINTENANCE AND ADJUSTMENT

## Panel C

### To remove the panel

1. Remove the bolts.

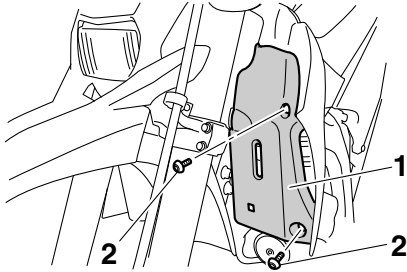

1. Panel C
2. Bolt

2. Lift the bottom of the panel slightly, and then slide the panel forward.

### To install the panel

Place the panel in the original position, and then install the bolts.

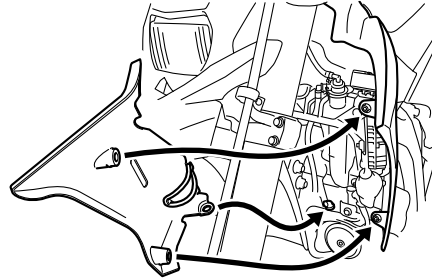

## Panel D

### To remove the panel

1. Remove the seat. (See page 3-13.)
2. Remove the bolt and washer, and then remove the panel as shown.

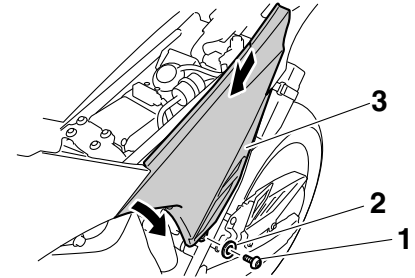

1. Bolt
2. Washer
3. Panel D

### To install the panel

1. Place the panel in the original position, and then install the washer and bolt.

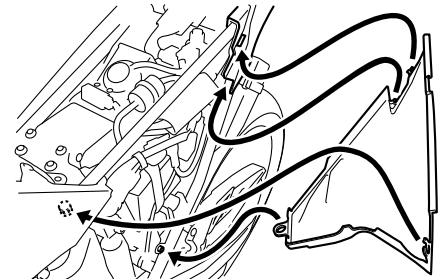

2. Install the seat.

# PERIODIC MAINTENANCE AND ADJUSTMENT

EAU48340

## Checking the spark plug

The spark plug is an important engine component, which should be checked periodically, preferably by a Yamaha dealer. Since heat and deposits will cause any spark plug to slowly erode, it should be removed and checked in accordance with the periodic maintenance and lubrication chart. In addition, the condition of the spark plug can reveal the condition of the engine.

The porcelain insulator around the center electrode of the spark plug should be a medium-to-light tan (the ideal color when the vehicle is ridden normally). If the spark plug shows a distinctly different color, the engine could be operating improperly. Do not attempt to diagnose such problems yourself. Instead, have a Yamaha dealer check the vehicle. If the spark plug shows signs of electrode erosion and excessive carbon or other deposits, it should be replaced.

**Specified spark plug:**  
NGK/CR9EK

Before installing a spark plug, the spark plug gap should be measured with a

wire thickness gauge and, if necessary, adjusted to specification.

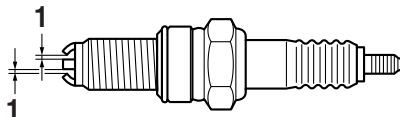

1. Spark plug gap

**Spark plug gap:**  
0.6–0.7 mm (0.024–0.028 in)

Clean the surface of the spark plug gasket and its mating surface, and then wipe off any grime from the spark plug threads.

**Tightening torque:**  
Spark plug:  
13 Nm (1.3 m·kgf, 9.4 ft·lbf)

## TIP

If a torque wrench is not available when installing a spark plug, a good estimate of the correct torque is 1/4–1/2 turn

past finger tight. However, the spark plug should be tightened to the specified torque as soon as possible.

ECA10840

## NOTICE

**Do not use any tools to remove or install the spark plug cap, otherwise the ignition coil coupler may get damaged. The spark plug cap may be difficult to remove because the rubber seal on the end of the cap fits tightly. To remove the spark plug cap, simply twist it back and forth while pulling it out; to install it, twist it back and forth while pushing it in.**

# PERIODIC MAINTENANCE AND ADJUSTMENT

EAU45143

## Engine oil and oil filter element

The engine oil level should be checked before each ride. In addition, the oil must be changed and the oil filter element replaced at the intervals specified in the periodic maintenance and lubrication chart.

### To check the engine oil level

1. Place the vehicle on a level surface and hold it in an upright position. A slight tilt to the side can result in a false reading.
2. Start the engine, warm it up for several minutes, and then turn it off.
3. Wait a few minutes until the oil settles, and then check the oil level through the check window located at the bottom-right side of the crankcase.

### TIP

The engine oil should be between the minimum and maximum level marks.

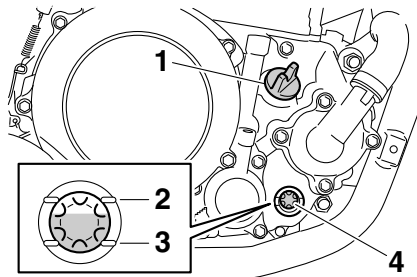

1. Engine oil filler cap
2. Maximum level mark
3. Minimum level mark
4. Engine oil level check window

4. If the engine oil is below the minimum level mark, add sufficient oil of the recommended type to raise it to the correct level.

### To change the engine oil (with or without oil filter element replacement)

1. Place the vehicle on a level surface.
2. Start the engine, warm it up for several minutes, and then turn it off.
3. Place an oil pan under the engine

to collect the used oil.

4. Remove the engine oil filler cap, the engine oil drain bolt and its gasket to drain the oil from the crankcase.

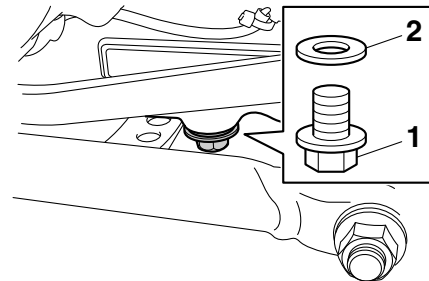

1. Engine oil drain bolt
2. Gasket

### TIP

Skip steps 5–8 if the oil filter element is not being replaced.

5. Remove the oil filter element cover by removing the bolts.

# PERIODIC MAINTENANCE AND ADJUSTMENT

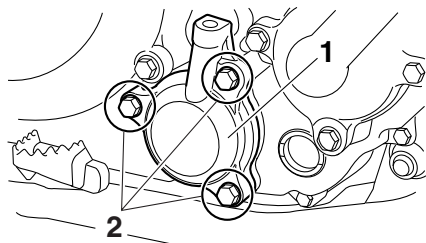

1. Oil filter element cover
  2. Oil filter element cover bolt
6. Remove the oil filter element and O-rings.

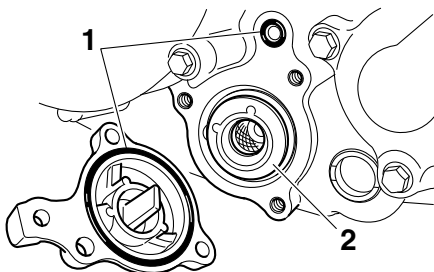

1. O-ring
  2. Oil filter element
7. Install a new oil filter element and new O-rings.

**TIP** \_\_\_\_\_  
Make sure that the O-rings are properly seated.

8. Install the oil filter element cover by installing the bolts, then tightening them to the specified torque.

**Tightening torque:**

Oil filter element cover bolt:  
10 Nm (1.0 m·kgf, 7.2 ft·lbf)

9. Install the engine oil drain bolt and its new gasket, and then tighten the bolt to the specified torque.

**Tightening torque:**

Engine oil drain bolt:  
20 Nm (2.0 m·kgf, 14 ft·lbf)

10. Refill with the specified amount of the recommended engine oil, and then install and tighten the oil filler cap.

**Recommended oil:**

See page 8-1.

**Oil quantity:**

Without oil filter element replacement:

1.30 L (1.37 US qt, 1.14 Imp.qt)

With oil filter element replacement:

1.40 L (1.48 US qt, 1.23 Imp.qt)

**TIP** \_\_\_\_\_  
Be sure to wipe off spilled oil on any parts after the engine and exhaust system have cooled down.

ECA11620

**NOTICE** \_\_\_\_\_

- In order to prevent clutch slippage (since the engine oil also lubricates the clutch), do not mix any chemical additives. Do not use oils with a diesel specification of “CD” or oils of a higher quality than specified. In addition, do not use oils labeled “ENERGY CONSERVING II” or higher.
- Make sure that no foreign material enters the crankcase.

11. Start the engine, and then let it idle for several minutes while checking

# PERIODIC MAINTENANCE AND ADJUSTMENT

EAU20070

it for oil leakage. If oil is leaking, immediately turn the engine off and check for the cause.

12. Turn the engine off, wait a few minutes until the oil settles, and then check the oil level and correct it if necessary.

ECA11231

## NOTICE

After changing the engine oil, make sure to check the oil pressure as described below.

- Loosen the bleed bolt.
- Start the engine and keep it idling until oil flows out. If no oil comes out after one minute, turn the engine off immediately so it will not seize. If this occurs, have a Yamaha dealer repair the vehicle.
- After checking the oil pressure, tighten the bleed bolt to the specified torque.

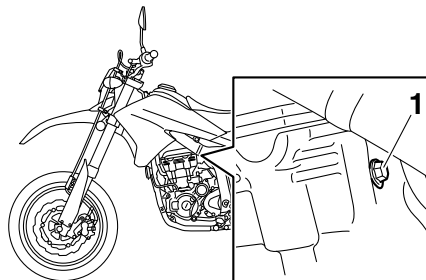

1. Bleed bolt

### Tightening torque:

Bleed bolt:  
10 Nm (1.0 m·kgf, 7.2 ft·lbf)

## Coolant

The coolant level should be checked before each ride. In addition, the coolant must be changed at the intervals specified in the periodic maintenance and lubrication chart.

EAU20254

### To check the coolant level

1. Place the vehicle on a level surface and hold it in an upright position.

### TIP

- The coolant level must be checked on a cold engine since the level varies with engine temperature.
- Make sure that the vehicle is positioned straight up when checking the coolant level. A slight tilt to the side can result in a false reading.

2. Check the coolant level in the coolant reservoir.

### TIP

The coolant should be between the minimum and maximum level marks.



# PERIODIC MAINTENANCE AND ADJUSTMENT

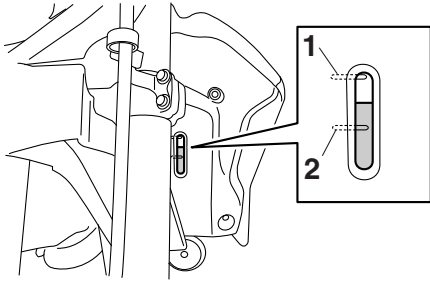

1. Maximum level mark
2. Minimum level mark

3. If the coolant is at or below the minimum level mark, remove panel C (See page 6-8.), remove the coolant reservoir cap, add coolant to the maximum level mark, and then install the reservoir cap and the panel. **WARNING! Remove only the coolant reservoir cap. Never attempt to remove the radiator cap when the engine is hot.**<sup>[EWA15161]</sup> **NOTICE:** If coolant is not available, use distilled water or soft tap water instead. Do not use hard water or salt water since it is harmful to the engine. If water has been used instead

of coolant, replace it with coolant as soon as possible, otherwise the cooling system will not be protected against frost and corrosion. If water has been added to the coolant, have a Yamaha dealer check the anti-freeze content of the coolant as soon as possible, otherwise the effectiveness of the coolant will be reduced.<sup>[ECA10472]</sup>

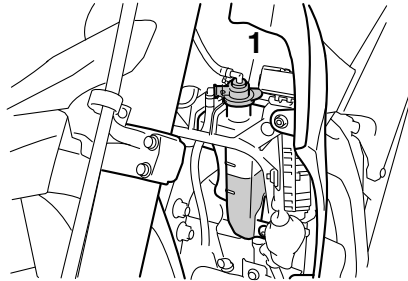

1. Coolant reservoir cap

**Coolant reservoir capacity (up to the maximum level mark):**  
0.25 L (0.26 US qt, 0.22 Imp.qt)

EAU45155

## To change the coolant

1. Place the vehicle on a level sur-

face and let the engine cool if necessary.

2. Remove panels A and C. (See page 6-8.)
3. Place a container under the engine to collect the used coolant.
4. Remove the radiator cap retaining bolt and radiator cap. **WARNING! Never attempt to remove the radiator cap when the engine is hot.**<sup>[EWA10381]</sup>

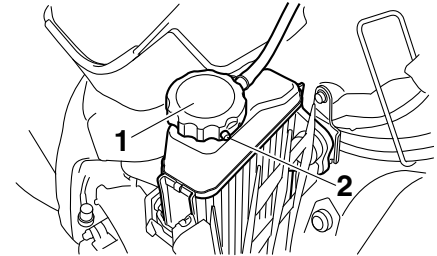

1. Radiator cap
2. Radiator cap retaining bolt

5. Remove the coolant reservoir by removing the bolts.

# PERIODIC MAINTENANCE AND ADJUSTMENT

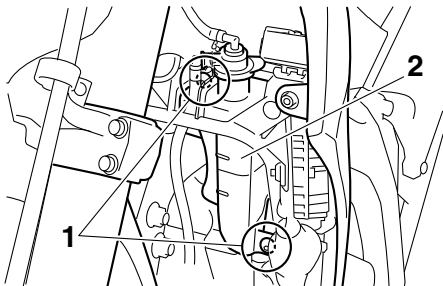

1. Bolt
2. Coolant reservoir

6. Remove the coolant reservoir cap.

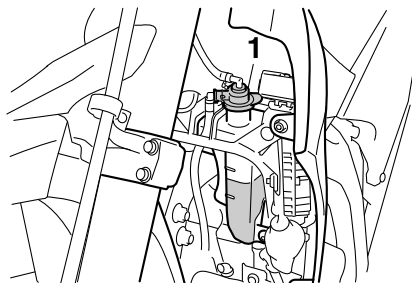

1. Coolant reservoir cap

7. Drain the coolant from the coolant reservoir by turning it upside down.
8. Install the coolant reservoir by placing it in the original position,

- and then installing the bolts.
9. Remove the coolant drain bolt and its gasket to drain the cooling system.

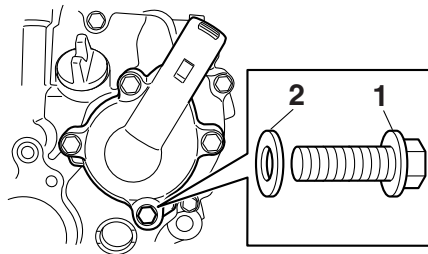

1. Coolant drain bolt
2. Gasket

10. After the coolant is completely drained, thoroughly flush the cooling system with clean tap water.
11. Install the coolant drain bolt and its new gasket, and then tighten the bolt to the specified torque.

## Tightening torque:

Coolant drain bolt:  
10 Nm (1.0 m·kgf, 7.2 ft·lbf)

12. Pour the specified amount of the recommended coolant into the ra-

diator and reservoir.

## Antifreeze/water mixture ratio:

1:1

## Recommended antifreeze:

High-quality ethylene glycol antifreeze containing corrosion inhibitors for aluminum engines

## Coolant quantity:

Radiator capacity (including all routes):

0.90 L (0.95 US qt, 0.79 Imp.qt)

Coolant reservoir capacity (up to the maximum level mark):

0.25 L (0.26 US qt, 0.22 Imp.qt)

13. Install the coolant reservoir cap.
14. Install the radiator cap.
15. Start the engine, let it idle for several minutes, and then turn it off.
16. Remove the radiator cap to check the coolant level in the radiator. If necessary, add sufficient coolant until it reaches the top of the radiator, and then install the radiator cap and its retaining bolt.
17. Check the coolant level in the reservoir. If necessary, remove the coolant reservoir cap, add coolant to the maximum level mark, and then install the cap.

# PERIODIC MAINTENANCE AND ADJUSTMENT

18. Start the engine, and then check the vehicle for coolant leakage. If coolant is leaking, have a Yamaha dealer check the cooling system.
19. Install the panels.

## Cleaning the air filter element and check hose

EAU44323

The air filter element should be cleaned or replaced at the intervals specified in the periodic maintenance and lubrication chart. Clean or, if necessary, replace the air filter element more frequently if you are riding in unusually wet or dusty areas. In addition, the air filter check hose must be frequently checked and cleaned if necessary.

### To clean the air filter element

1. Remove panel B. (See page 6-8.)
2. Open the air filter case cover by removing the screw and pulling the case cover outward as shown.

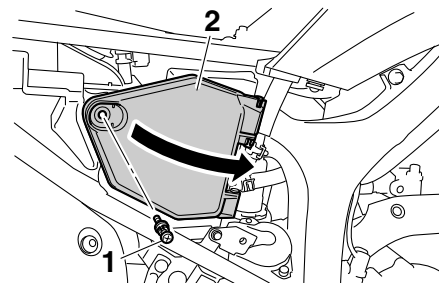

1. Screw
2. Air filter case cover

3. Unhook the holding clip, and then pull the air filter element out.

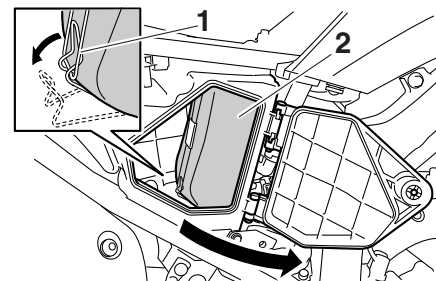

1. Holding clip
2. Air filter element

4. Remove the sponge material from the air filter element frame, clean it

# PERIODIC MAINTENANCE AND ADJUSTMENT

with solvent, and then squeeze the remaining solvent out. **WARNING!** Use only a dedicated parts cleaning solvent. To avoid the risk of fire or explosion, do not use gasoline or solvents with a low flash point.<sup>[EWA10431]</sup> **NOTICE:** To avoid damaging the foam material, handle it gently and carefully, and do not twist or wring it.<sup>[ECA10511]</sup>

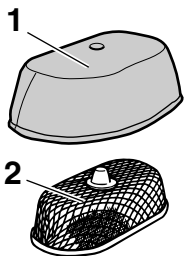

1. Sponge material
2. Air filter element frame

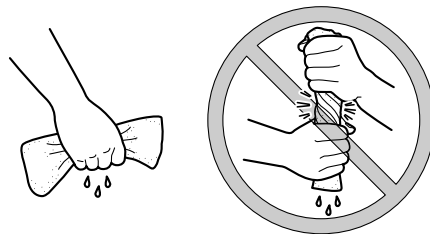

5. Apply oil of the recommended type to the entire surface of the sponge material, and then squeeze the excess oil out.

## TIP

The sponge material should be wet but not dripping.

### Recommended oil:

Yamaha foam air filter oil or other quality foam air filter oil

6. Pull the sponge material over the air filter element frame.
7. Insert the air filter element into the air filter case. **NOTICE: Make sure that the air filter element is properly seated in the air filter case. The engine should never be op-**

erated without the air filter element installed, otherwise the piston(s) and/or cylinder(s) may become excessively worn.<sup>[ECA10481]</sup>

8. Place the holding clip in the original position.
9. Close the air filter case cover, and then install the screw.
10. Install the panel.

## To clean the air filter check hose

1. Check the hose at the bottom of the air filter case for accumulated dirt or water.

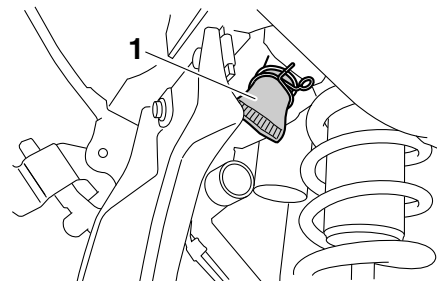

1. Air filter check hose
2. If dirt or water is visible, remove the hose, clean it, and then install it.

# PERIODIC MAINTENANCE AND ADJUSTMENT

EAU45322

## Adjusting the engine idling speed

The engine idling speed must be checked and, if necessary, adjusted as follows.

### TIP

A digital tachometer is needed to make this adjustment.

1. Position the digital tachometer at the ignition coil, which is located in the spark plug cap.
2. Check the engine idling speed and, if necessary, adjust it to specification by turning the idle adjusting screw. To increase the engine idling speed, turn the screw in direction (a). To decrease the engine idling speed, turn the screw in direction (b).

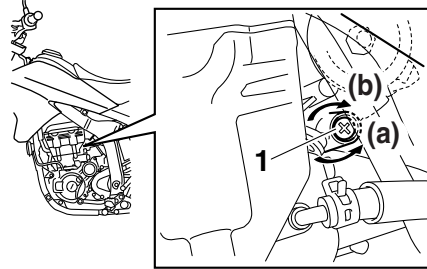

1. Idle adjusting screw

**Engine idling speed:**  
1450–1650 r/min

### TIP

If the specified idling speed cannot be obtained as described above, have a Yamaha dealer make the adjustment.

EAU21384

## Checking the throttle grip free play

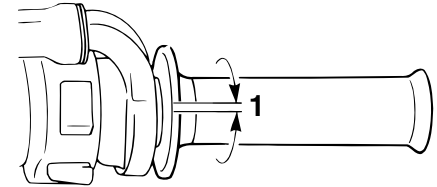

1. Throttle grip free play

The throttle grip free play should measure 3.0–5.0 mm (0.12–0.20 in) at the inner edge of the throttle grip. Periodically check the throttle grip free play and, if necessary, have a Yamaha dealer adjust it.

# PERIODIC MAINTENANCE AND ADJUSTMENT

EAU21401

## Valve clearance

The valve clearance changes with use, resulting in improper air-fuel mixture and/or engine noise. To prevent this from occurring, the valve clearance must be adjusted by a Yamaha dealer at the intervals specified in the periodic maintenance and lubrication chart.

EAU21643

## Tires

To maximize the performance, durability, and safe operation of your motorcycle, note the following points regarding the specified tires.

### Tire air pressure

The tire air pressure should be checked and, if necessary, adjusted before each ride.

EWA10503



Operation of this vehicle with improper tire pressure may cause severe injury or death from loss of control.

- The tire air pressure must be checked and adjusted on cold tires (i.e., when the temperature of the tires equals the ambient temperature).
- The tire air pressure must be adjusted in accordance with the riding speed and with the total weight of rider, passenger, cargo, and accessories approved for this model.

### Tire air pressure (measured on cold tires):

#### 0–90 kg (0–198 lb):

Front:

200 kPa (2.00 kgf/cm<sup>2</sup>, 29 psi)

Rear:

200 kPa (2.00 kgf/cm<sup>2</sup>, 29 psi)

#### 90–185 kg (198–408 lb):

Front:

200 kPa (2.00 kgf/cm<sup>2</sup>, 29 psi)

Rear:

225 kPa (2.25 kgf/cm<sup>2</sup>, 33 psi)

#### Maximum load\*:

185 kg (408 lb)

\* Total weight of rider, passenger, cargo and accessories

EWA10511



Never overload your vehicle. Operation of an overloaded vehicle could cause an accident.

# PERIODIC MAINTENANCE AND ADJUSTMENT

## Tire inspection

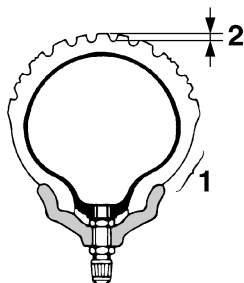

1. Tire sidewall
2. Tire tread depth

The tires must be checked before each ride. If the center tread depth reaches the specified limit, if the tire has a nail or glass fragments in it, or if the sidewall is cracked, have a Yamaha dealer replace the tire immediately.

**Minimum tire tread depth (front and rear):**  
1.6 mm (0.06 in)

## TIP

The tire tread depth limits may differ from country to country. Always comply with the local regulations.

## Tire information

This motorcycle is equipped with tube tires.

EWA10461

### **! WARNING**

The front and rear tires should be of the same make and design, otherwise the handling characteristics of the vehicle may be different, which could lead to an accident.

After extensive tests, only the tires listed below have been approved for this model by Yamaha Motor Co., Ltd.

#### Front tire:

Size:

110/70R17M/C 54H

Manufacturer/model:

BRIDGESTONE/BT090F RADIAL  
G

#### Rear tire:

Size:

140/70R17M/C 66H

Manufacturer/model:

BRIDGESTONE/BT090R RADIAL  
G

EWA10571

### **! WARNING**

- Have a Yamaha dealer replace excessively worn tires. Besides

being illegal, operating the motorcycle with excessively worn tires decreases riding stability and can lead to loss of control.

- The replacement of all wheel- and brake-related parts, including the tires, should be left to a Yamaha dealer, who has the necessary professional knowledge and experience.
- It is not recommended to patch a punctured tube. If unavoidable, however, patch the tube very carefully and replace it as soon as possible with a high-quality product.
- Ride at moderate speeds after changing a tire since the tire surface must first be “broken in” for it to develop its optimal characteristics.

# PERIODIC MAINTENANCE AND ADJUSTMENT

## Spoke wheels

EAU21943

EWA10610

### **⚠ WARNING**

The wheels on this model are not designed for use with tubeless tires. Do not attempt to use tubeless tires on this model.

To maximize the performance, durability, and safe operation of your motorcycle, note the following points regarding the specified wheels.

- The wheel rims should be checked for cracks, bends, warpage or other damage, and the spokes for looseness or damage before each ride. If any damage is found, have a Yamaha dealer replace the wheel. Do not attempt even the smallest repair to the wheel. A deformed or cracked wheel must be replaced.
- The wheel should be balanced whenever either the tire or wheel has been changed or replaced. An unbalanced wheel can result in poor performance, adverse handling characteristics, and a shortened tire life.

## Adjusting the clutch lever free play

EAU48373

The clutch lever free play should measure 10.0–15.0 mm (0.39–0.59 in) as shown. Periodically check the clutch lever free play and, if necessary, adjust it as follows.

1. Slide the rubber cover back at the clutch lever.
2. Loosen the locknut.
3. To increase the clutch lever free play, turn the clutch lever free play adjusting bolt in direction (a). To decrease the clutch lever free play, turn the adjusting bolt in direction (b).

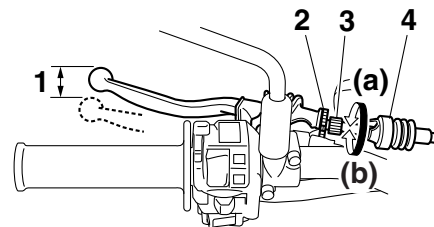

1. Clutch lever free play
2. Locknut (clutch lever)
3. Clutch lever free play adjusting bolt
4. Rubber cover

### **TIP**

If the specified clutch lever free play could be obtained as described above, skip steps 4–7.

4. Fully turn the adjusting bolt in direction (a) to loosen the clutch cable.
5. Slide the rubber cover back further down the clutch cable, and then loosen the locknut.
6. To increase the clutch lever free play, turn the clutch lever free play adjusting nut in direction (a). To decrease the clutch lever free play,



# PERIODIC MAINTENANCE AND ADJUSTMENT

turn the adjusting nut in direction (b).

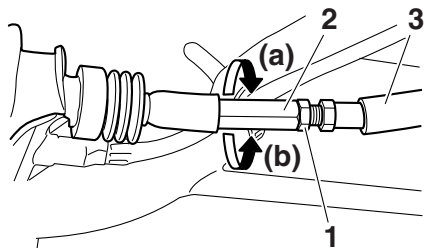

1. Locknut (clutch cable)
2. Clutch lever free play adjusting nut (clutch cable)
3. Rubber cover
7. Tighten the locknut at the clutch cable, and then slide the rubber cover to its original position.
8. Tighten the locknut at the clutch lever, and then slide the rubber cover to its original position.

## Adjusting the brake lever free play

EAU48442

The brake lever free play should measure 5.0–8.0 mm (0.20–0.31 in) as shown. Periodically check the brake lever free play and, if necessary, adjust it as follows.

1. Slide the rubber cover back at the brake lever.
2. Loosen the locknut.
3. To increase the brake lever free play, turn the brake lever free play adjusting screw in direction (a). To decrease the brake lever free play, turn the adjusting screw in direction (b).

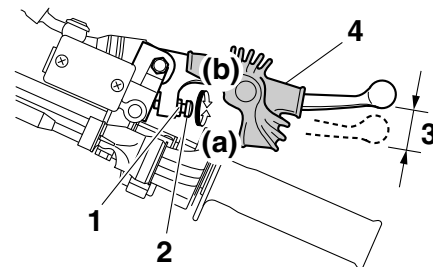

1. Locknut
2. Brake lever free play adjusting screw
3. Brake lever free play
4. Rubber cover
4. Tighten the locknut, and then slide the rubber cover back to its original position.

### **WARNING**

- After adjusting the brake lever free play, check the free play and make sure that the brake is working properly.
- A soft or spongy feeling in the brake lever can indicate the presence of air in the hydraulic system. If there is air in the hydraulic system, have a Yamaha

EWA10630

# PERIODIC MAINTENANCE AND ADJUSTMENT

dealer bleed the system before operating the motorcycle. Air in the hydraulic system will diminish the braking performance, which may result in loss of control and an accident.

## Checking the shift pedal

The operation of the shift pedal should be checked before each ride. If operation is not smooth, have a Yamaha dealer check the vehicle.

EAU44820

## Brake light switches

EAU22273

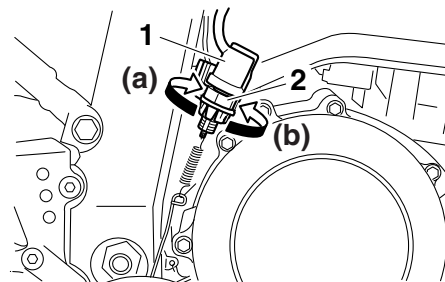

1. Rear brake light switch
2. Rear brake light switch adjusting nut

The brake light, which is activated by the brake pedal and brake lever, should come on just before braking takes effect. If necessary, adjust the rear brake light switch as follows, but the front brake light switch should be adjusted by a Yamaha dealer.

Turn the rear brake light switch adjusting nut while holding the rear brake light switch in place. To make the brake light come on earlier, turn the adjusting nut in direction (a). To make the brake light come on later, turn the adjusting nut in direction (b).

# PERIODIC MAINTENANCE AND ADJUSTMENT

## Checking the front and rear brake pads

EAU22392

The front and rear brake pads must be checked for wear at the intervals specified in the periodic maintenance and lubrication chart.

### Front brake pads

EAU22430

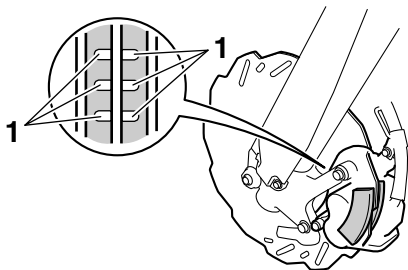

1. Brake pad wear indicator groove

Each front brake pad is provided with wear indicator grooves, which allow you to check the brake pad wear without having to disassemble the brake. To check the brake pad wear, check the wear indicator grooves. If a brake pad has worn to the point that the wear indicator grooves have almost disap-

peared, have a Yamaha dealer replace the brake pads as a set.

### Rear brake pads

EAU48070

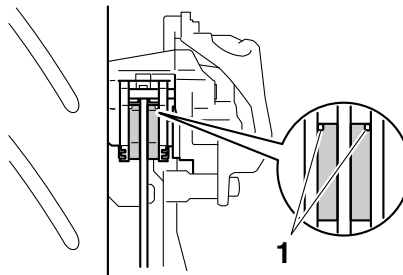

1. Brake pad wear indicator groove

Each rear brake pad is provided with a wear indicator groove, which allows you to check the brake pad wear without having to disassemble the brake. To check the brake pad wear, check the wear indicator groove. If a brake pad has worn to the point that the wear indicator groove almost appears, have a Yamaha dealer replace the brake pads as a set.

## Checking the brake fluid level

EAU22581

Before riding, check that the brake fluid is above the minimum level mark. Check the brake fluid level with the top of the reservoir level. Replenish the brake fluid if necessary.

### Front brake

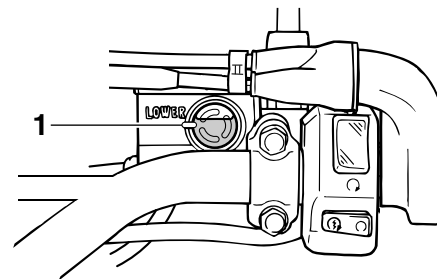

1. Minimum level mark

# PERIODIC MAINTENANCE AND ADJUSTMENT

EAU22731

## Rear brake

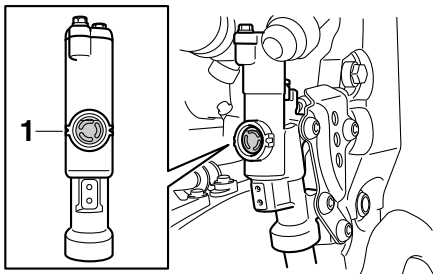

1. Minimum level mark

**Specified brake fluid:**  
DOT 4

ECA17640

6

### **⚠ WARNING**

EWA15990

Improper maintenance can result in loss of braking ability. Observe these precautions:

- Insufficient brake fluid may allow air to enter the brake system, reducing braking performance.
- Clean the filler cap before removing. Use only DOT 4 brake fluid from a sealed container.
- Use only the specified brake fluid; otherwise, the rubber seals

may deteriorate, causing leakage.

- Refill with the same type of brake fluid. Adding a brake fluid other than DOT 4 may result in a harmful chemical reaction.
- Be careful that water does not enter the brake fluid reservoir when refilling. Water will significantly lower the boiling point of the fluid and may result in vapor lock.

### **NOTICE**

**Brake fluid may damage painted surfaces or plastic parts. Always clean up spilled fluid immediately.**

As the brake pads wear, it is normal for the brake fluid level to gradually go down. A low brake fluid level may indicate worn brake pads and/or brake system leakage; therefore, be sure to check the brake pads for wear and the brake system for leakage. If the brake fluid level goes down suddenly, have a Yamaha dealer check the cause before further riding.

## Changing the brake fluid

Have a Yamaha dealer change the brake fluid at the intervals specified in the TIP after the periodic maintenance and lubrication chart. In addition, have the oil seals of the master cylinders and calipers as well as the brake hoses replaced at the intervals listed below or whenever they are damaged or leaking.

- Oil seals: Replace every two years.
- Brake hoses: Replace every four years.

# PERIODIC MAINTENANCE AND ADJUSTMENT

## Drive chain slack

EAU22760

The drive chain slack should be checked before each ride and adjusted if necessary.

EAU47222

### To check the drive chain slack

1. Place the motorcycle on the side-stand.

### TIP

When checking and adjusting the drive chain slack, there should be no weight on the motorcycle.

2. Shift the transmission into the neutral position.
3. Push on the drive chain at the center point between the chain tensioner and the chain support mounting bolt with a force of 50 N (5.0 kgf, 11 lbf).
4. Measure drive chain slack between the swingarm and the top of the chain link closest to the swingarm as shown.

#### Drive chain slack:

8.0–13.0 mm (0.31–0.51 in)

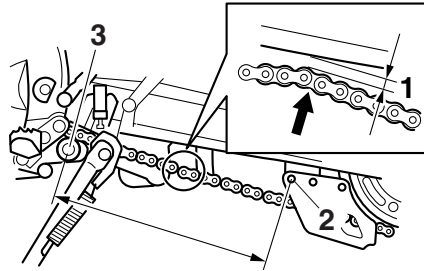

1. Drive chain slack
  2. Chain support mounting bolt
  3. Chain tensioner
5. If the drive chain slack is incorrect, adjust it as follows.

### To adjust the drive chain slack

Consult a Yamaha dealer before adjusting the drive chain slack.

1. Loosen the axle nut and the locknut on each side of the swingarm.
2. To tighten the drive chain, turn the drive chain slack adjusting bolt on each side of the swingarm in direction (a). To loosen the drive chain, turn the adjusting bolt on each side of the swingarm in direction (b), and then push the rear wheel forward.

EAU34317

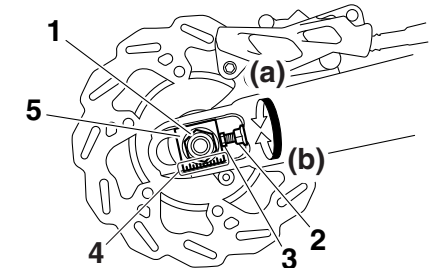

1. Axle nut
2. Locknut
3. Drive chain slack adjusting bolt
4. Alignment marks
5. Drive chain puller

### TIP

Using the alignment marks on each side of the swingarm, make sure that both drive chain pullers are in the same position for proper wheel alignment.

# PERIODIC MAINTENANCE AND ADJUSTMENT

3. Tighten the axle nut, then the locknuts to their specified torques.

## Tightening torques:

Axle nut:

125 Nm (12.5 m·kgf, 90 ft·lbf)

Locknut:

16 Nm (1.6 m·kgf, 12 ft·lbf)

4. Make sure that the drive chain pullers are in the same position, the drive chain slack is correct, and the drive chain moves smoothly.

EAU23025

## Cleaning and lubricating the drive chain

The drive chain must be cleaned and lubricated at the intervals specified in the periodic maintenance and lubrication chart, otherwise it will quickly wear out, especially when riding in dusty or wet areas. Service the drive chain as follows.

ECA10583

### NOTICE

**The drive chain must be lubricated after washing the motorcycle, riding in the rain or riding in wet areas.**

1. Clean the drive chain with kerosene and a small soft brush.

**NOTICE: To prevent damaging the O-rings, do not clean the drive chain with steam cleaners, high-pressure washers or inappropriate solvents.**<sup>[ECA11121]</sup>

2. Wipe the drive chain dry.
3. Thoroughly lubricate the drive chain with a special O-ring chain lubricant. **NOTICE: Do not use engine oil or any other lubricants for the drive chain, as they**

**may contain substances that could damage the O-rings.**<sup>[ECA11111]</sup>

# PERIODIC MAINTENANCE AND ADJUSTMENT

EAU23095

## Checking and lubricating the cables

The operation of all control cables and the condition of the cables should be checked before each ride, and the cables and cable ends should be lubricated if necessary. If a cable is damaged or does not move smoothly, have a Yamaha dealer check or replace it. **WARNING! Damage to the outer housing of cables may result in internal rusting and cause interference with cable movement. Replace damaged cables as soon as possible to prevent unsafe conditions.**<sup>[EWA10711]</sup>

### Recommended lubricant:

Yamaha Chain and Cable Lube or engine oil

EAU23114

## Checking and lubricating the throttle grip and cable

The operation of the throttle grip should be checked before each ride. In addition, the cable should be lubricated by a Yamaha dealer at the intervals specified in the periodic maintenance chart. The throttle cable is equipped with a rubber cover. Make sure that the cover is securely installed. Even though the cover is installed correctly, it does not completely protect the cable from water entry. Therefore, use care not to pour water directly onto the cover or cable when washing the vehicle. If the cable or cover becomes dirty, wipe clean with a moist cloth.

EAU23142

## Checking and lubricating the brake and clutch levers

### Brake lever

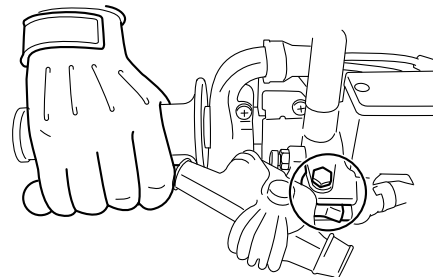

### Clutch lever

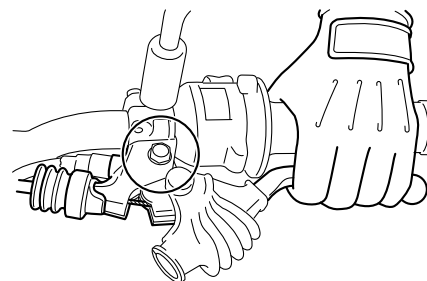

The operation of the brake and clutch levers should be checked before each ride, and the lever pivots should be lubricated if necessary.

# PERIODIC MAINTENANCE AND ADJUSTMENT

## Recommended lubricants:

- Brake lever:
  - Silicone grease
- Clutch lever:
  - Lithium-soap-based grease

6

## Checking and lubricating the brake pedal

EAU23182

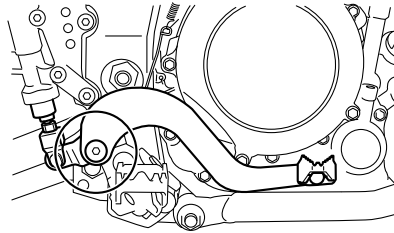

The operation of the brake pedal should be checked before each ride, and the pedal pivot should be lubricated if necessary.

## Recommended lubricant:

Lithium-soap-based grease

## Checking and lubricating the sidestand

EAU23202

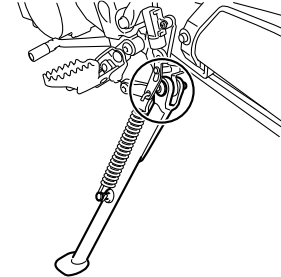

The operation of the sidestand should be checked before each ride, and the sidestand pivot and metal-to-metal contact surfaces should be lubricated if necessary.

EWA10731

## **⚠ WARNING**

If the sidestand does not move up and down smoothly, have a Yamaha dealer check or repair it. Otherwise, the sidestand could contact the ground and distract the operator, resulting in a possible loss of control.

## Recommended lubricant:

Lithium-soap-based grease



# PERIODIC MAINTENANCE AND ADJUSTMENT

EAM1652

## Lubricating the swingarm pivots

The swingarm pivots must be lubricated by a Yamaha dealer at the intervals specified in the periodic maintenance and lubrication chart.

**Recommended lubricant:**  
Lithium-soap-based grease

EAU23272

## Checking the front fork

The condition and operation of the front fork must be checked as follows at the intervals specified in the periodic maintenance and lubrication chart.

### To check the condition

Check the inner tubes for scratches, damage and excessive oil leakage.

### To check the operation

1. Place the vehicle on a level surface and hold it in an upright position. **WARNING! To avoid injury, securely support the vehicle so there is no danger of it falling over.**<sup>[EWA10751]</sup>
2. While applying the front brake, push down hard on the handlebars several times to check if the front fork compresses and rebounds smoothly.

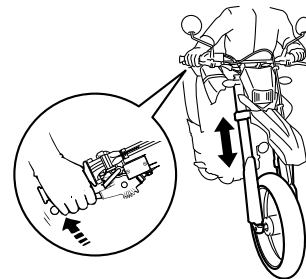

ECA10590

### **NOTICE**

**If any damage is found or the front fork does not operate smoothly, have a Yamaha dealer check or repair it.**

# PERIODIC MAINTENANCE AND ADJUSTMENT

EAU23283

## Checking the steering

Worn or loose steering bearings may cause danger. Therefore, the operation of the steering must be checked as follows at the intervals specified in the periodic maintenance and lubrication chart.

1. Place a stand under the engine to raise the front wheel off the ground. (See page 6-38 for more information.) **WARNING! To avoid injury, securely support the vehicle so there is no danger of it falling over.**<sup>[EWA10751]</sup>
2. Hold the lower ends of the front fork legs and try to move them forward and backward. If any free play can be felt, have a Yamaha dealer check or repair the steering.

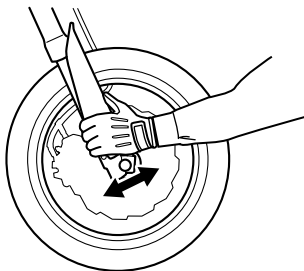

EAU23291

## Checking the wheel bearings

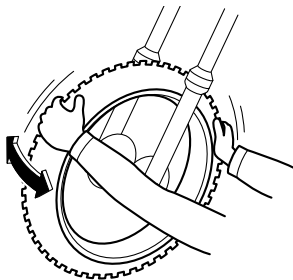

The front and rear wheel bearings must be checked at the intervals specified in the periodic maintenance and lubrication chart. If there is play in the wheel hub or if the wheel does not turn smoothly, have a Yamaha dealer check the wheel bearings.

EAU46343

## Battery

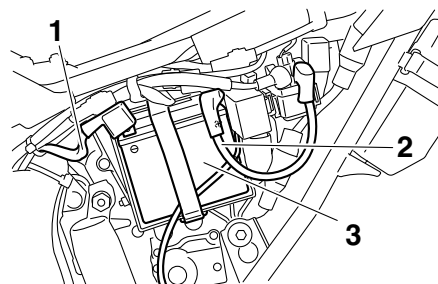

1. Negative battery lead (black)
2. Positive battery lead (red)
3. Battery

The battery is located behind panel D. (See page 6-8.)

This model is equipped with a VRLA (Valve Regulated Lead Acid) battery. There is no need to check the electrolyte or to add distilled water. However, the battery lead connections need to be checked and, if necessary, securely tightened.

EWA10760

### **WARNING**

- **Electrolyte is poisonous and dangerous since it contains sulfuric acid, which causes severe**

# PERIODIC MAINTENANCE AND ADJUSTMENT

burns. Avoid any contact with skin, eyes or clothing and always shield your eyes when working near batteries. In case of contact, administer the following FIRST AID.

- **EXTERNAL:** Flush with plenty of water.
- **INTERNAL:** Drink large quantities of water or milk and immediately call a physician.
- **EYES:** Flush with water for 15 minutes and seek prompt medical attention.
- **Batteries produce explosive hydrogen gas. Therefore, keep sparks, flames, cigarettes, etc., away from the battery and provide sufficient ventilation when charging it in an enclosed space.**
- **KEEP THIS AND ALL BATTERIES OUT OF THE REACH OF CHILDREN.**

## To charge the battery

Have a Yamaha dealer charge the battery as soon as possible if it seems to

have discharged. Keep in mind that the battery tends to discharge more quickly if the vehicle is equipped with optional electrical accessories.

ECA16521

### **NOTICE**

To charge a VRLA (Valve Regulated Lead Acid) battery, a special (constant-voltage) battery charger is required. Using a conventional battery charger will damage the battery.

## To store the battery

1. If the model will not be used for more than one month, remove the battery, fully charge it, and then place it in a cool, dry place.  
**NOTICE:** When removing the battery, be sure the key is turned to “OFF”, then disconnect the negative lead before disconnecting the positive lead.[ECA16302]
2. If the battery will be stored for more than two months, check it at least once a month and fully charge it if necessary.
3. Fully charge the battery before in-

stallation. **NOTICE:** When installing the battery, be sure the key is turned to “OFF”, then connect the positive lead before connecting the negative lead.[ECA16840]

ECA16530

### **NOTICE**

Always keep the battery charged. Storing a discharged battery can cause permanent battery damage.

# PERIODIC MAINTENANCE AND ADJUSTMENT

EAU23542

## Replacing the fuses

The main fuse is located behind panel D. (See page 6-8.)

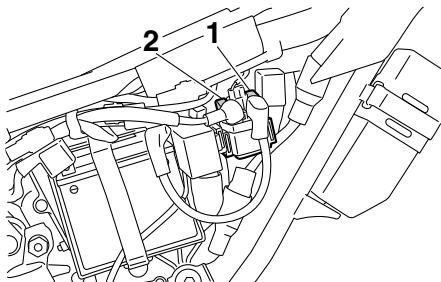

1. Main fuse
2. Spare main fuse

The fuse box, which contains the fuses for the individual circuits, is located behind panel C. (See page 6-8.)

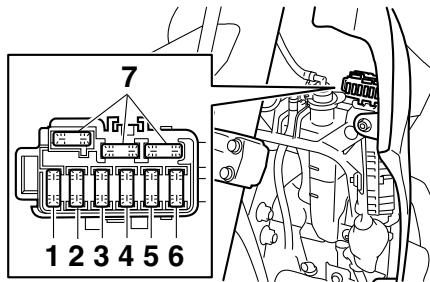

1. Fuel injection system fuse
2. Radiator fan fuse
3. Backup fuse
4. Ignition fuse
5. Signaling system fuse
6. Headlight fuse
7. Spare fuse

If a fuse is blown, replace it as follows.

1. Turn the key to "OFF" and turn off the electrical circuit in question.
2. Remove the blown fuse, and then install a new fuse of the specified amperage. **WARNING! Do not use a fuse of a higher amperage rating than recommended to avoid causing extensive damage to the electrical system and possibly a fire.**<sup>[EWA15131]</sup>

### Specified fuses:

- Main fuse:  
30.0 A
- Ignition fuse:  
7.5 A
- Signaling system fuse:  
10.0 A
- Headlight fuse:  
15.0 A
- Radiator fan fuse:  
7.5 A
- Backup fuse:  
7.5 A
- Fuel injection system fuse:  
7.5 A

3. Turn the key to "ON" and turn on the electrical circuit in question to check if the device operates.
4. If a fuse immediately blows again, have a Yamaha dealer check the electrical system.

# PERIODIC MAINTENANCE AND ADJUSTMENT

EAU45215

## Replacing the headlight bulb

This model is equipped with a halogen bulb headlight. If the headlight bulb burns out, replace it as follows.

ECA10650

### NOTICE

Take care not to damage the following parts:

- Headlight bulb

Do not touch the glass part of the headlight bulb to keep it free from oil, otherwise the transparency of the glass, the luminosity of the bulb, and the bulb life will be adversely affected. Thoroughly clean off any dirt and fingerprints on the headlight bulb using a cloth moistened with alcohol or thinner.

- Headlight lens

Do not affix any type of tinted film or stickers to the headlight lens.

Do not use a headlight bulb of a wattage higher than specified.

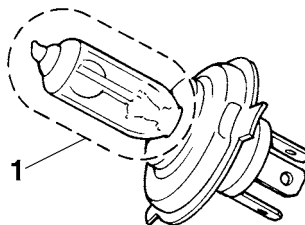

1. Do not touch the glass part of the bulb.

1. Remove the headlight cowling together with the headlight unit by removing the bolts and pulling upward as shown.

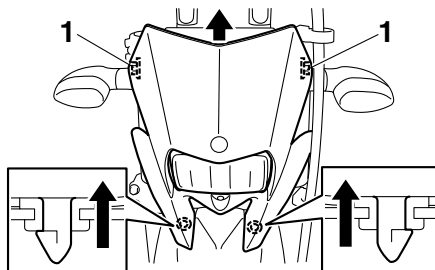

1. Bolt

2. Disconnect the headlight coupler, and then remove the headlight

bulb cover.

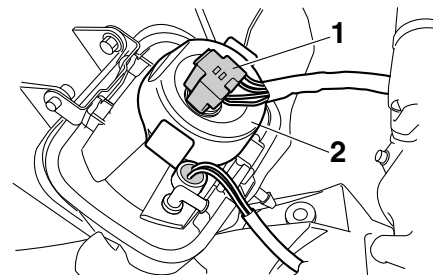

1. Headlight coupler
2. Headlight bulb cover

3. Unhook the headlight bulb holder, and then remove the burnt-out bulb.

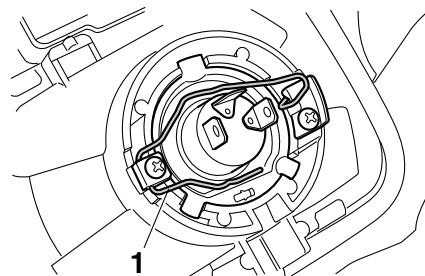

1. Headlight bulb holder

4. Place a new headlight bulb into po-

# PERIODIC MAINTENANCE AND ADJUSTMENT

sition, and then secure it with the bulb holder.

5. Install the bulb cover, and then connect the coupler.
6. Install the headlight cowling (together with the headlight unit) by placing it in the original position, and then installing the bolts.
7. Have a Yamaha dealer adjust the headlight beam if necessary.

## Tail/brake light

This model is equipped with an LED-type tail/brake light.

If the tail/brake light does not come on, have a Yamaha dealer check it.

EAU24181

EAU24204

## Replacing a turn signal light bulb

1. Remove the turn signal light lens by removing the screw.

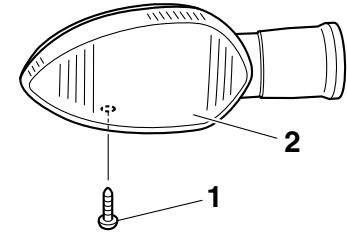

1. Screw
  2. Turn signal light lens
2. Remove the burnt-out bulb by pushing it in and turning it counter-clockwise.

# PERIODIC MAINTENANCE AND ADJUSTMENT

EAU24313

## Replacing the license plate light bulb

1. Remove the license plate light unit by removing the screws.

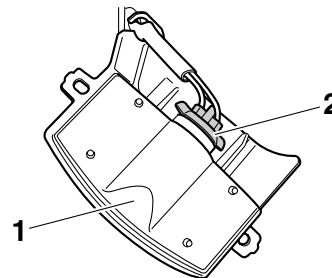

1. License plate light unit
2. License plate light bulb socket

3. Remove the burnt-out bulb by pulling it out.
4. Insert a new bulb into the socket.
5. Install the socket (together with the bulb) by pushing it in.
6. Install the license plate light unit by installing the screws.

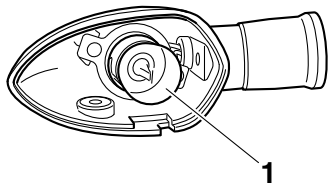

1. Turn signal light bulb

3. Insert a new bulb into the socket, push it in, and then turn it clockwise until it stops.
4. Install the lens by installing the screw. **NOTICE: Do not over-tighten the screw, otherwise the lens may break.**<sup>[ECA11191]</sup>

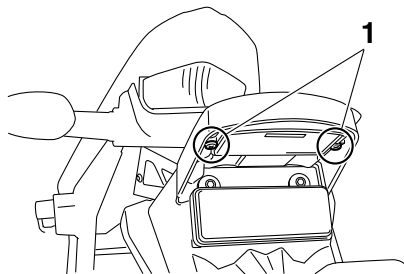

1. Screw
2. Remove the license plate light bulb socket (together with the bulb) by pulling it out.

# PERIODIC MAINTENANCE AND ADJUSTMENT

EAU45224

## Replacing an auxiliary light bulb

If the auxiliary light bulb burns out, replace it as follows.

1. Remove the headlight unit. (See page 6-35.)
2. Remove the auxiliary light bulb socket (together with the bulb) by pulling it out.

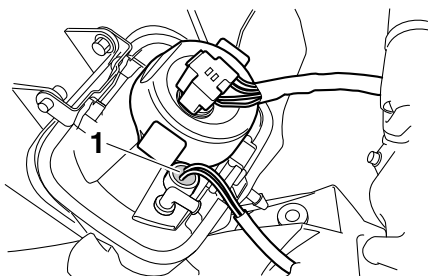

1. Auxiliary light bulb socket
3. Remove the burnt-out bulb by pulling it out.
4. Insert a new bulb into the socket.
5. Install the socket (together with the bulb) by pushing it in.
6. Install the headlight unit.

EAU24350

## Supporting the motorcycle

Since this model is not equipped with a centerstand, follow these precautions when removing the front and rear wheel or performing other maintenance requiring the motorcycle to stand upright. Check that the motorcycle is in a stable and level position before starting any maintenance. A strong wooden box can be placed under the engine for added stability.

### To service the front wheel

1. Stabilize the rear of the motorcycle by using a motorcycle stand or, if an additional motorcycle stand is not available, by placing a jack under the frame in front of the rear wheel.
2. Raise the front wheel off the ground by using a motorcycle stand.

### To service the rear wheel

Raise the rear wheel off the ground by using a motorcycle stand or, if a motorcycle stand is not available, by placing a jack either under each side of the

frame in front of the rear wheel or under each side of the swingarm.



# PERIODIC MAINTENANCE AND ADJUSTMENT

## Front wheel

EAU24360

### To remove the front wheel

EAU45163

EWA10821



#### WARNING

To avoid injury, securely support the vehicle so there is no danger of it falling over.

1. Loosen the front wheel axle pinch bolts and axle nut.

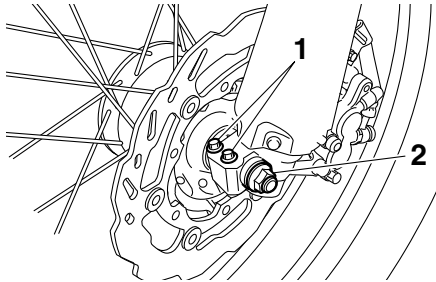

1. Front wheel axle pinch bolt
2. Axle nut

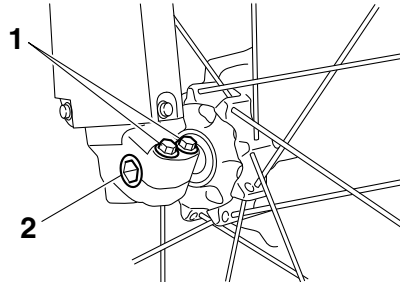

1. Front wheel axle pinch bolt
2. Wheel axle
2. Lift the front wheel off the ground according to the procedure in the previous section "Supporting the motorcycle".
3. Remove the axle nut.
4. Pull the wheel axle out.
5. Remove the spacers and the wheel. **NOTICE: Do not apply the brake after the wheel has been removed together with the brake disc, otherwise the brake pads will be forced shut.**<sup>[ECA11071]</sup>

EAU45174

### To install the front wheel

1. Install the spacers into both sides of the wheel hub. **NOTICE: When**

installing the spacers, be sure to install them on the correct side.<sup>[ECA17700]</sup>

2. Lift the wheel up between the fork legs.

#### TIP

Make sure that there is enough space between the brake pads before installing the brake caliper onto the brake disc.

3. Insert the wheel axle from the right-hand side.
4. Install the axle nut.
5. Lower the front wheel so that it is on the ground, and then put the sidestand down.
6. Tighten the axle nut, and then the front wheel axle pinch bolts to the specified torques.

#### Tightening torques:

Axle nut:

63 Nm (6.3 m·kgf, 46 ft·lbf)

Front wheel axle pinch bolt:

23 Nm (2.3 m·kgf, 17 ft·lbf)

7. Push down hard on the handlebar several times to check for proper fork operation.

# PERIODIC MAINTENANCE AND ADJUSTMENT

## Rear wheel

EAU25080

### To remove the rear wheel

EAU45183

EWA10821

#### **⚠ WARNING**

To avoid injury, securely support the vehicle so there is no danger of it falling over.

1. Loosen the axle nut.

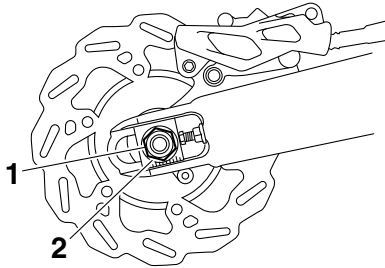

1. Axle nut
2. Washer

2. Lift the rear wheel off the ground according to the procedure on page 6-38.
3. Remove the axle nut and washer.
4. Loosen the locknut on each side of the swingarm.

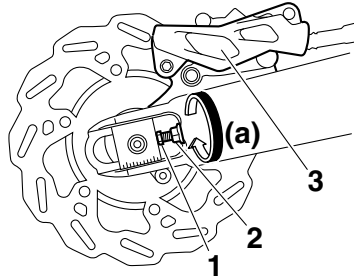

1. Drive chain slack adjusting bolt
2. Locknut
3. Brake caliper
5. Turn the drive chain slack adjusting bolts fully in direction (a).
6. Push the wheel forward, and then remove the drive chain from the rear sprocket.

#### **TIP**

The drive chain does not need to be disassembled in order to remove and install the rear wheel.

7. While supporting the brake caliper, pull the wheel axle out.

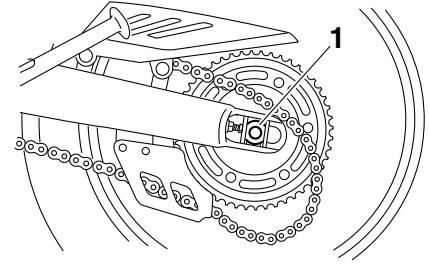

1. Wheel axle
8. Remove the drive chain pullers, spacers and the wheel. **NOTICE:** Do not apply the brake after the wheel has been removed together with the brake disc, otherwise the brake pads will be forced shut. [ECA11071]

EAU45193

### To install the rear wheel

1. Install the spacers into both sides of the wheel hub. **NOTICE:** When installing the spacers, be sure to install them on the correct side. [ECA17700]
2. Install the wheel, drive chain pullers and the brake caliper bracket by inserting the wheel axle from

# PERIODIC MAINTENANCE AND ADJUSTMENT

EAU25871

the left-hand side.

## TIP

- Make sure that the retainer on the brake caliper bracket is inserted into the slot in the swingarm.
- Make sure that there is enough space between the brake pads before installing the wheel.

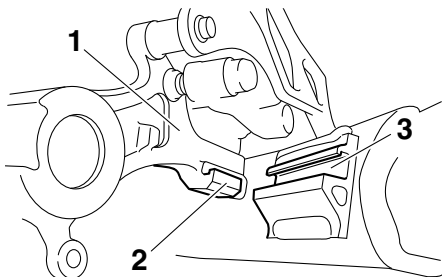

1. Brake caliper bracket
2. Retainer
3. Slot

3. Install the drive chain onto the rear sprocket.
4. Install the washer and the axle nut.
5. Lower the rear wheel so that it is on the ground, and then put the sidestand down.
6. Adjust the drive chain slack. (See

page 6-27.)

7. Tighten the axle nut, and then the locknuts to their specified torques.

### Tightening torques:

Axle nut:

125 Nm (12.5 m·kgf, 90 ft·lbf)

Locknut:

16 Nm (1.6 m·kgf, 12 ft·lbf)

## Troubleshooting

Although Yamaha motorcycles receive a thorough inspection before shipment from the factory, trouble may occur during operation. Any problem in the fuel, compression, or ignition systems, for example, can cause poor starting and loss of power.

The following troubleshooting charts represent quick and easy procedures for checking these vital systems yourself. However, should your motorcycle require any repair, take it to a Yamaha dealer, whose skilled technicians have the necessary tools, experience, and know-how to service the motorcycle properly.

Use only genuine Yamaha replacement parts. Imitation parts may look like Yamaha parts, but they are often inferior, have a shorter service life and can lead to expensive repair bills.

EWA15141

### WARNING

**When checking the fuel system, do not smoke, and make sure there are no open flames or sparks in the area, including pilot lights from water**

# **PERIODIC MAINTENANCE AND ADJUSTMENT**

---

heaters or furnaces. Gasoline or gasoline vapors can ignite or explode, causing severe injury or property damage.

---

## Troubleshooting charts

### Starting problems or poor engine performance

#### 1. Fuel

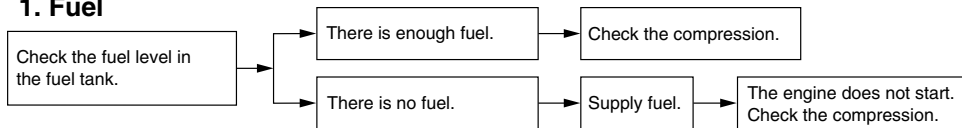

#### 2. Compression

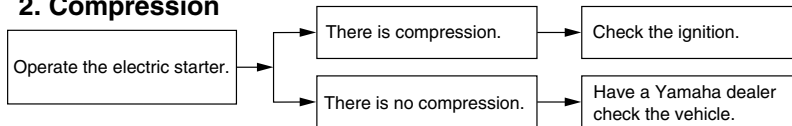

#### 3. Ignition

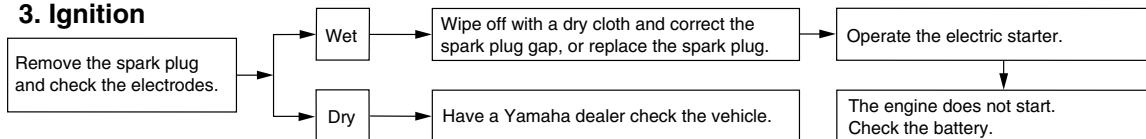

#### 4. Battery

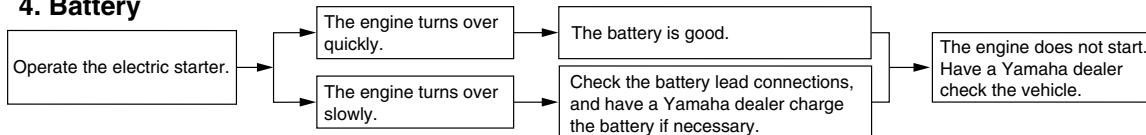

# PERIODIC MAINTENANCE AND ADJUSTMENT

## Engine overheating

EWA10400

### WARNING

- Do not remove the radiator cap when the engine and radiator are hot. Scalding hot fluid and steam may be blown out under pressure, which could cause serious injury. Be sure to wait until the engine has cooled.
- After removing the radiator cap retaining bolt, place a thick rag, like a towel, over the radiator cap, and then slowly rotate the cap counterclockwise to the detent to allow any residual pressure to escape. When the hissing sound has stopped, press down on the cap while turning it counterclockwise, and then remove the cap.

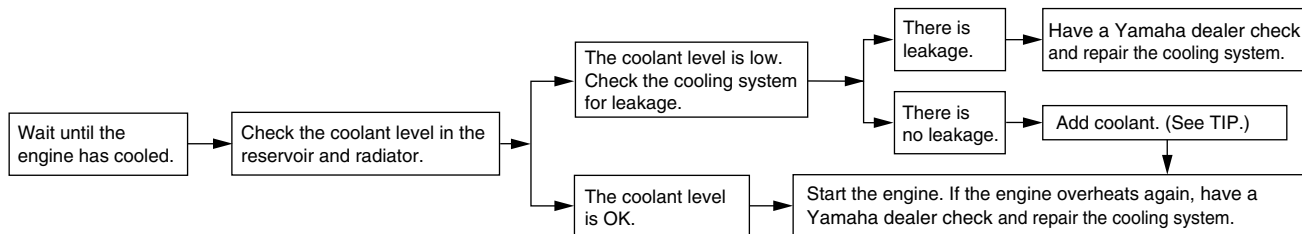

### TIP

If coolant is not available, tap water can be temporarily used instead, provided that it is changed to the recommended coolant as soon as possible.

## Matte color caution

EAU37833

EAU26004

### NOTICE

Some models are equipped with matte colored finished parts. Be sure to consult a Yamaha dealer for advice on what products to use before cleaning the vehicle. Using a brush, harsh chemical products or cleaning compounds when cleaning these parts will scratch or damage their surface. Wax also should not be applied to any matte colored finished parts.

ECA15192

## Care

While the open design of a motorcycle reveals the attractiveness of the technology, it also makes it more vulnerable. Rust and corrosion can develop even if high-quality components are used. A rusty exhaust pipe may go unnoticed on a car, however, it detracts from the overall appearance of a motorcycle. Frequent and proper care does not only comply with the terms of the warranty, but it will also keep your motorcycle looking good, extend its life and optimize its performance.

### Before cleaning

1. Cover the muffler outlet with a plastic bag after the engine has cooled down.
2. Make sure that all caps and covers as well as all electrical couplers and connectors, including the spark plug cap, are tightly installed.
3. Remove extremely stubborn dirt, like oil burnt onto the crankcase, with a degreasing agent and a brush, but never apply such prod-

ucts onto seals, gaskets, sprockets, the drive chain and wheel axles. Always rinse the dirt and degreaser off with water.

## Cleaning

ECA10772

### NOTICE

- Avoid using strong acidic wheel cleaners, especially on spoked wheels. If such products are used on hard-to-remove dirt, do not leave the cleaner on the affected area any longer than instructed. Also, thoroughly rinse the area off with water, immediately dry it, and then apply a corrosion protection spray.
- Improper cleaning can damage plastic parts (such as cowlings, panels, windshields, headlight lenses, meter lenses, etc.) and the mufflers. Use only a soft, clean cloth or sponge with water to clean plastic. However, if the plastic parts cannot be thoroughly cleaned with water, diluted mild detergent with water may be used. Be sure to rinse

# MOTORCYCLE CARE AND STORAGE

---

off any detergent residue using plenty of water, as it is harmful to plastic parts.

- Do not use any harsh chemical products on plastic parts. Be sure to avoid using cloths or sponges which have been in contact with strong or abrasive cleaning products, solvent or thinner, fuel (gasoline), rust removers or inhibitors, brake fluid, antifreeze or electrolyte.
- Do not use high-pressure washers or steam-jet cleaners since they cause water seepage and deterioration in the following areas: seals (of wheel and swing-arm bearings, fork and brakes), electric components (couplers, connectors, instruments, switches and lights), breather hoses and vents.
- For motorcycles equipped with a windshield: Do not use strong cleaners or hard sponges as they will cause dulling or scratching. Some cleaning compounds for plastic may leave scratches on the windshield.

**Test the product on a small hidden part of the windshield to make sure that it does not leave any marks. If the windshield is scratched, use a quality plastic polishing compound after washing.**

---

## After normal use

Remove dirt with warm water, a mild detergent, and a soft, clean sponge, and then rinse thoroughly with clean water. Use a toothbrush or bottlebrush for hard-to-reach areas. Stubborn dirt and insects will come off more easily if the area is covered with a wet cloth for a few minutes before cleaning.

## After riding in the rain, near the sea or on salt-sprayed roads

Since sea salt or salt sprayed on roads during winter are extremely corrosive in combination with water, carry out the following steps after each ride in the rain, near the sea or on salt-sprayed roads.

## **TIP**

---

Salt sprayed on roads in the winter may

remain well into spring.

1. Clean the motorcycle with cold water and a mild detergent, after the engine has cooled down.  
**NOTICE: Do not use warm water since it increases the corrosive action of the salt.**[ECA10791]
2. Apply a corrosion protection spray on all metal, including chrome- and nickel-plated, surfaces to prevent corrosion.

## **After cleaning**

1. Dry the motorcycle with a chamois or an absorbing cloth.
2. Immediately dry the drive chain and lubricate it to prevent it from rusting.
3. Use a chrome polish to shine chrome, aluminum and stainless-steel parts, including the exhaust system. (Even the thermally induced discoloring of stainless-steel exhaust systems can be removed through polishing.)
4. To prevent corrosion, it is recommended to apply a corrosion protection spray on all metal,



including chrome- and nickel-plated, surfaces.

5. Use spray oil as a universal cleaner to remove any remaining dirt.
6. Touch up minor paint damage caused by stones, etc.
7. Wax all painted surfaces.
8. Let the motorcycle dry completely before storing or covering it.

EWA11131

## WARNING

**Contaminants on the brakes or tires can cause loss of control.**

- **Make sure that there is no oil or wax on the brakes or tires.**
- **If necessary, clean the brake discs and brake linings with a regular brake disc cleaner or acetone, and wash the tires with warm water and a mild detergent. Before riding at higher speeds, test the motorcycle's braking performance and cornering behavior.**

ECA10800

## NOTICE

- **Apply spray oil and wax sparingly and make sure to wipe off**

**any excess.**

- **Never apply oil or wax to any rubber and plastic parts, but treat them with a suitable care product.**
- **Avoid using abrasive polishing compounds as they will wear away the paint.**

## TIP

- Consult a Yamaha dealer for advice on what products to use.
- Washing, rainy weather or humid climates can cause the headlight lens to fog. Turning the headlight on for a short period of time will help remove the moisture from the lens.

## Storage

### Short-term

Always store your motorcycle in a cool, dry place and, if necessary, protect it against dust with a porous cover. Be sure the engine and the exhaust system are cool before covering the motorcycle.

ECA10810

## NOTICE

- **Storing the motorcycle in a poorly ventilated room or covering it with a tarp, while it is still wet, will allow water and humidity to seep in and cause rust.**
- **To prevent corrosion, avoid damp cellars, stables (because of the presence of ammonia) and areas where strong chemicals are stored.**

### Long-term

Before storing your motorcycle for several months:

1. Follow all the instructions in the "Care" section of this chapter.
2. Fill up the fuel tank and add fuel

# MOTORCYCLE CARE AND STORAGE

---

stabilizer (if available) to prevent the fuel tank from rusting and the fuel from deteriorating.

3. Perform the following steps to protect the cylinder, piston rings, etc. from corrosion.
  - a. Remove the spark plug cap and spark plug.
  - b. Pour a teaspoonful of engine oil into the spark plug bore.
  - c. Install the spark plug cap onto the spark plug, and then place the spark plug on the cylinder head so that the electrodes are grounded. (This will limit sparking during the next step.)
  - d. Turn the engine over several times with the starter. (This will coat the cylinder wall with oil.)
  - e. Remove the spark plug cap from the spark plug, and then install the spark plug and the spark plug cap. **WARNING! To prevent damage or injury from sparking, make sure to ground the spark plug electrodes while turning the engine over.**<sup>[EWA10951]</sup>
4. Lubricate all control cables and the

pivoting points of all levers and pedals as well as of the sidestand/centerstand.

5. Check and, if necessary, correct the tire air pressure, and then lift the motorcycle so that both of its wheels are off the ground. Alternatively, turn the wheels a little every month in order to prevent the tires from becoming degraded in one spot.
6. Cover the muffler outlet with a plastic bag to prevent moisture from entering it.
7. Remove the battery and fully charge it. Store it in a cool, dry place and charge it once a month. Do not store the battery in an excessively cold or warm place [less than 0 °C (30 °F) or more than 30 °C (90 °F)]. For more information on storing the battery, see page 6-32.

## TIP

---

Make any necessary repairs before storing the motorcycle.

---

## Dimensions:

- Overall length:  
2115 mm (83.3 in)
- Overall width:  
810 mm (31.9 in)
- Overall height:  
1190 mm (46.9 in)
- Seat height:  
895 mm (35.2 in)
- Wheelbase:  
1425 mm (56.1 in)
- Ground clearance:  
265 mm (10.43 in)
- Minimum turning radius:  
2300 mm (90.6 in)

## Weight:

- Curb weight:  
136 kg (300 lb)

## Engine:

- Engine type:  
Liquid cooled 4-stroke, DOHC
- Cylinder arrangement:  
Single cylinder
- Displacement:  
250 cm<sup>3</sup>
- Bore × stroke:  
77.0 × 53.6 mm (3.03 × 2.11 in)
- Compression ratio:  
11.80 : 1
- Starting system:  
Electric starter
- Lubrication system:  
Wet sump

## Engine oil:

- Recommended brand:  
YAMALUBE
- Type:  
SAE 10W-30, 10W-40, 10W-50, 15W-40,  
20W-40 or 20W-50

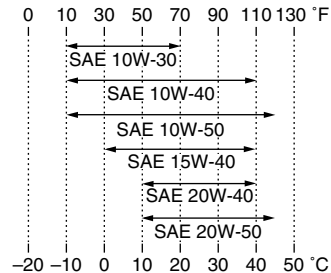

- Recommended engine oil grade:  
API service SG type or higher, JASO standard MA
- Engine oil quantity:  
Without oil filter element replacement:  
1.30 L (1.37 US qt, 1.14 Imp.qt)  
With oil filter element replacement:  
1.40 L (1.48 US qt, 1.23 Imp.qt)

## Cooling system:

- Coolant reservoir capacity (up to the maximum level mark):  
0.25 L (0.26 US qt, 0.22 Imp.qt)
- Radiator capacity (including all routes):  
0.90 L (0.95 US qt, 0.79 Imp.qt)

## Air filter:

- Air filter element:  
Wet element

## Fuel:

- Recommended fuel:  
Premium unleaded gasoline only
- Fuel tank capacity:  
8.0 L (2.11 US gal, 1.76 Imp.gal)
- Fuel reserve amount:  
2.1 L (0.55 US gal, 0.46 Imp.gal)

## Fuel injection:

- Throttle body:  
ID mark:  
3D71 10

## Spark plug(s):

- Manufacturer/model:  
NGK/CR9EK
- Spark plug gap:  
0.6–0.7 mm (0.024–0.028 in)

## Clutch:

- Clutch type:  
Wet, multiple-disc

## Transmission:

- Primary reduction ratio:  
3.120 (78/25)
- Final drive:  
Chain
- Secondary reduction ratio:  
3.231 (42/13)
- Transmission type:  
Constant mesh 6-speed
- Operation:  
Left foot operation

# SPECIFICATIONS

## Gear ratio:

- 1st:  
2.642 (37/14)
- 2nd:  
1.813 (29/16)
- 3rd:  
1.318 (29/22)
- 4th:  
1.040 (26/25)
- 5th:  
0.889 (24/27)
- 6th:  
0.786 (22/28)

## Chassis:

- Frame type:  
Semi double cradle
- Caster angle:  
25.33 °
- Trail:  
76 mm (3.0 in)

## Front tire:

- Type:  
With tube
- Size:  
110/70R17M/C 54H
- Manufacturer/model:  
BRIDGESTONE/BT090F RADIAL G

## Rear tire:

- Type:  
With tube
- Size:  
140/70R17M/C 66H
- Manufacturer/model:  
BRIDGESTONE/BT090R RADIAL G

## Loading:

- Maximum load:  
185 kg (408 lb)
- \* (Total weight of rider, passenger, cargo and accessories)

## Tire air pressure (measured on cold tires):

- Loading condition:  
0–90 kg (0–198 lb)
- Front:  
200 kPa (2.00 kgf/cm<sup>2</sup>, 29 psi)
- Rear:  
200 kPa (2.00 kgf/cm<sup>2</sup>, 29 psi)
- Loading condition:  
90–185 kg (198–408 lb)
- Front:  
200 kPa (2.00 kgf/cm<sup>2</sup>, 29 psi)
- Rear:  
225 kPa (2.25 kgf/cm<sup>2</sup>, 33 psi)

## Front wheel:

- Wheel type:  
Spoke wheel
- Rim size:  
17M/C x MT3.00

## Rear wheel:

- Wheel type:  
Spoke wheel
- Rim size:  
17M/C x MT4.00

## Front brake:

- Type:  
Single disc brake
- Operation:  
Right hand operation

- Specified brake fluid:  
DOT 4

## Rear brake:

- Type:  
Single disc brake
- Operation:  
Right foot operation
- Specified brake fluid:  
DOT 4

## Front suspension:

- Type:  
Telescopic fork
- Spring/shock absorber type:  
Coil spring/oil damper
- Wheel travel:  
270.0 mm (10.63 in)

## Rear suspension:

- Type:  
Swingarm (link suspension)
- Spring/shock absorber type:  
Coil spring/gas-oil damper
- Wheel travel:  
265.0 mm (10.43 in)

## Electrical system:

- Ignition system:  
TCI
- Charging system:  
AC magneto

## Battery:

- Model:  
YTZ7S
- Voltage, capacity:  
12 V, 6.0 Ah

## Headlight:

Bulb type:

Halogen bulb

## Bulb voltage, wattage × quantity:

Headlight:

12 V, 60 W/55 W

Tail/brake light:

LED

Front turn signal light:

12 V, 10.0 W × 2

Rear turn signal light:

12 V, 10.0 W × 2

Auxiliary light:

12 V, 5.0 W × 1

License plate light:

12 V, 5.0 W × 1

Meter lighting:

EL (Electroluminescent)

Neutral indicator light:

LED

High beam indicator light:

LED

Turn signal indicator light:

LED

Fuel level warning light:

LED

Coolant temperature warning light:

LED

Engine trouble warning light:

LED

## Fuses:

Main fuse:

30.0 A

Headlight fuse:

15.0 A

Signaling system fuse:

10.0 A

Ignition fuse:

7.5 A

Radiator fan fuse:

7.5 A

Fuel injection system fuse:

7.5 A

Backup fuse:

7.5 A

# CONSUMER INFORMATION

EAU48612

## Identification numbers

Record the vehicle identification number and model label information in the spaces provided below for assistance when ordering spare parts from a Yamaha dealer or for reference in case the vehicle is stolen.

VEHICLE IDENTIFICATION  
NUMBER:

MODEL LABEL INFORMATION:

EAU26400

## Vehicle identification number

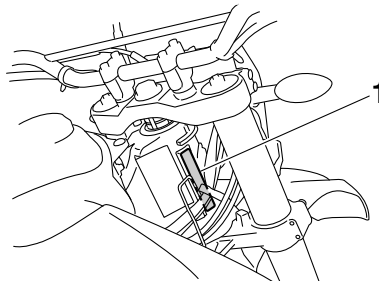

1. Vehicle identification number

The vehicle identification number is stamped into the steering head pipe. Record this number in the space provided.

### TIP \_\_\_\_\_

The vehicle identification number is used to identify your motorcycle and may be used to register your motorcycle with the licensing authority in your area.

---

EAU26460

## Model label

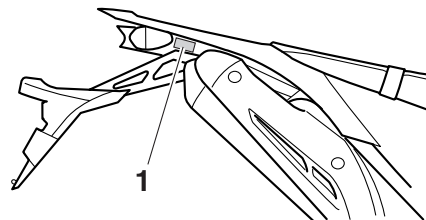

1. Model label

The model label is affixed to the location shown. Record the information on this label in the space provided. This information will be needed when ordering spare parts from a Yamaha dealer.

<b>A</b>	Air filter element and check hose, cleaning ..... 6-17 Auxiliary light bulb, replacing ..... 6-38	<b>F</b>	Front and rear brake pads, checking ..... 6-25 Front fork, adjusting ..... 3-14 Front fork, bleeding ..... 3-16 Front fork, checking ..... 6-31 Fuel ..... 3-11 Fuel consumption, tips for reducing ..... 5-3 Fuel level warning light ..... 3-2 Fuel tank cap ..... 3-11 Fuses, replacing ..... 6-34	Part locations ..... 2-1	
<b>B</b>	Battery ..... 6-32 Brake and clutch levers, checking and lubricating ..... 6-29 Brake fluid, changing ..... 6-26 Brake fluid level, checking ..... 6-25 Brake lever ..... 3-10 Brake lever free play, adjusting ..... 6-23 Brake light switches ..... 6-24 Brake pedal ..... 3-10 Brake pedal, checking and lubricating ..... 6-30	<b>H</b>	Handlebar switches ..... 3-8 Headlight bulb, replacing ..... 6-35 Helmet holder ..... 3-14 High beam indicator light ..... 3-2 Horn switch ..... 3-9	<b>S</b>	Safety information ..... 1-1 Seat ..... 3-13 Shifting ..... 5-2 Shift pedal ..... 3-10 Shift pedal, checking ..... 6-24 Shock absorber assembly, adjusting ..... 3-17 Sidestand ..... 3-19 Sidestand, checking and lubricating ..... 6-30 Spark plug, checking ..... 6-11 Specifications ..... 8-1 Starting the engine ..... 5-1 Start switch ..... 3-9 Steering, checking ..... 6-32 Storage ..... 7-3 Supporting the motorcycle ..... 6-38 Swingarm pivots, lubricating ..... 6-31
<b>C</b>	Cables, checking and lubricating ..... 6-29 Care ..... 7-1 Catalytic converter ..... 3-13 Clutch lever ..... 3-9 Clutch lever free play, adjusting ..... 6-22 Coolant ..... 6-14 Coolant temperature warning light ..... 3-2	<b>I</b>	Identification numbers ..... 9-1 Ignition circuit cut-off system ..... 3-19 Indicator lights and warning lights ..... 3-2	<b>T</b>	Tail/brake light ..... 6-36 Throttle grip and cable, checking and lubricating ..... 6-29 Throttle grip free play, checking ..... 6-19 Tires ..... 6-20 Tool kit ..... 6-2 Troubleshooting ..... 6-41 Troubleshooting charts ..... 6-43 Turn signal indicator light ..... 3-2 Turn signal light bulb, replacing ..... 6-36 Turn signal switch ..... 3-9
<b>D</b>	Dimmer switch ..... 3-9 Drive chain, cleaning and lubricating ..... 6-28 Drive chain slack ..... 6-27	<b>L</b>	License plate light bulb, replacing ..... 6-37	<b>V</b>	Valve clearance ..... 6-20 Vehicle identification number ..... 9-1
<b>E</b>	Engine break-in ..... 5-3 Engine idling speed ..... 6-19 Engine oil and oil filter element ..... 6-12 Engine stop switch ..... 3-9 Engine trouble warning light ..... 3-3 EXUP system ..... 3-18	<b>M</b>	Main switch/steering lock ..... 3-1 Maintenance and lubrication, periodic ..... 6-4 Maintenance, emission control system ..... 6-3 Matte color, caution ..... 7-1 Model label ..... 9-1 Multi-function display ..... 3-3		
		<b>N</b>	Neutral indicator light ..... 3-2		
		<b>P</b>	Panels, removing and installing ..... 6-8 Parking ..... 5-4		

# INDEX

---

## W

Wheel bearings, checking.....	6-32
Wheel (front) .....	6-39
Wheel (rear) .....	6-40
Wheels .....	6-22







PRINTED ON RECYCLED PAPER

PRINTED IN JAPAN  
2011.10-0.1×1   
(E)