



⚠ Read this manual carefully before operating this vehicle.

OWNER'S MANUAL

AEROX

YQ50
YQ50L

3C6-F8199-E1

Welcome to the Yamaha world of motorcycling!

As the owner of the YQ50/YQ50L, you are benefiting from Yamaha's vast experience and newest technology regarding the design and manufacture of high-quality products, which have earned Yamaha a reputation for dependability.

Please take the time to read this manual thoroughly, so as to enjoy all advantages of your YQ50/YQ50L. The Owner's Manual does not only instruct you in how to operate, inspect and maintain your scooter, but also in how to safeguard yourself and others from trouble and injury.

In addition, the many tips given in this manual will help keep your scooter in the best possible condition. If you have any further questions, do not hesitate to contact your Yamaha dealer.

The Yamaha team wishes you many safe and pleasant rides. So, remember to put safety first!

Yamaha continually seeks advancements in product design and quality. Therefore, while this manual contains the most current product information available at the time of printing, there may be minor discrepancies between your scooter and this manual. If there is any question concerning this manual, please consult a Yamaha dealer.



Please read this manual carefully and completely before operating this scooter.

IMPORTANT MANUAL INFORMATION

EAU10132

Particularly important information is distinguished in this manual by the following notations:

	This is the safety alert symbol. It is used to alert you to potential personal injury hazards. Obey all safety messages that follow this symbol to avoid possible injury or death.
	A WARNING indicates a hazardous situation which, if not avoided, could result in death or serious injury.
NOTICE	A NOTICE indicates special precautions that must be taken to avoid damage to the vehicle or other property.
TIP	A TIP provides key information to make procedures easier or clearer.

IMPORTANT MANUAL INFORMATION

EAUM1010

**YQ50/YQ50L
OWNER'S MANUAL
©2008 by MBK INDUSTRIE
1st edition, July 2008
All rights reserved
Any reprinting or unauthorized use
without the written permission of
MBK INDUSTRIE
is expressly prohibited.
Printed in France.**

TABLE OF CONTENTS

SAFETY INFORMATION	1-1	FOR YOUR SAFETY –		Checking the front and rear	
Further safe-riding points	1-5	PRE-OPERATION CHECKS	4-1	brake pads	6-14
DESCRIPTION	2-1	OPERATION AND IMPORTANT		Checking the brake fluid level	6-15
Left view	2-1	RIDING POINTS	5-1	Changing the brake fluid	6-16
Right view	2-2	Starting a cold engine	5-1	Checking and lubricating the	
INSTRUMENT AND CONTROL		Starting off	5-2	throttle grip and cable	6-16
FUNCTIONS	3-1	Acceleration and deceleration	5-2	Lubricating the front and rear	
Main switch/steering lock	3-1	Braking	5-2	brake levers	6-16
Indicator and warning lights	3-2	Tips for reducing fuel		Checking and lubricating the	
Speedometer unit	3-3	consumption	5-3	centerstand	6-17
Tachometer (if equipped)	3-3	Engine break-in	5-3	Checking the front fork	6-17
Fuel gauge	3-4	Parking	5-4	Checking the steering	6-18
Handlebar switches	3-4	PERIODIC MAINTENANCE AND		Checking the wheel bearings	6-18
Front brake lever	3-5	ADJUSTMENT	6-1	Battery	6-19
Rear brake lever	3-5	Periodic maintenance and		Replacing the fuse	6-20
Fuel tank cap	3-5	lubrication chart	6-2	Replacing the headlight bulb	6-21
Fuel	3-6	Removing and installing the		Replacing the tail/brake light	
Catalytic converters	3-7	cowling and panel	6-6	bulb	6-22
2-stroke engine oil	3-8	Checking the spark plug	6-7	Replacing a turn signal light	
Kickstarter	3-9	Final transmission oil	6-8	bulb	6-22
Rider seat	3-9	Coolant	6-9	Troubleshooting	6-23
Storage compartments	3-10	Cleaning the air filter element	6-10	Troubleshooting charts	6-24
Adjusting the shock absorber		Adjusting the carburetor	6-11	SCOOTER CARE AND STORAGE ...	7-1
assembly (if equipped)	3-11	Checking the throttle cable free		Care	7-1
		play	6-11	Storage	7-3
		Tires	6-12	SPECIFICATIONS	8-1
		Cast wheels	6-13	CONSUMER INFORMATION	9-1
		Checking the front and rear brake		Identification numbers	9-1
		lever free play	6-14		

EAUT1012

Be a Responsible Owner

As the vehicle's owner, you are responsible for the safe and proper operation of your scooter.

Scooters are single-track vehicles.

Their safe use and operation are dependent upon the use of proper riding techniques as well as the expertise of the operator. Every operator should know the following requirements before riding this scooter.

He or she should:

- Obtain thorough instructions from a competent source on all aspects of scooter operation.
- Observe the warnings and maintenance requirements in this Owner's Manual.
- Obtain qualified training in safe and proper riding techniques.
- Obtain professional technical service as indicated in this Owner's Manual and/or when made necessary by mechanical conditions.

Safe Riding

Perform the pre-operation checks each time you use the vehicle to make sure it is in safe operating condition. Failure to inspect or maintain the vehicle properly increases the possibility of an accident or equipment damage. See page 4-1 for a list of pre-operation checks.

- This scooter is designed to carry the operator and a passenger.

TIP

Although this scooter is designed to carry a passenger, always comply with the local regulations.

- The failure of motorists to detect and recognize scooters in traffic is the predominating cause of automobile/scooter accidents. Many accidents have been caused by an automobile driver who did not see the scooter. Making yourself conspicuous appears to be very effective in reducing the chance of this type of accident.

Therefore:

- Wear a brightly colored jacket.

- Use extra caution when you are approaching and passing through intersections, since intersections are the most likely places for scooter accidents to occur.
- Ride where other motorists can see you. Avoid riding in another motorist's blind spot.
- Many accidents involve inexperienced operators. In fact, many operators who have been involved in accidents do not even have a current driver's license.
 - Make sure that you are qualified and that you only lend your scooter to other qualified operators.
 - Know your skills and limits. Staying within your limits may help you to avoid an accident.
 - We recommend that you practice riding your scooter where there is no traffic until you have become thoroughly familiar with the scooter and all of its controls.

SAFETY INFORMATION

1

- Many accidents have been caused by error of the scooter operator. A typical error made by the operator is veering wide on a turn due to excessive speed or undercornering (insufficient lean angle for the speed).
- Never ride under the influence of alcohol or other drugs.
- This scooter is designed for on-road use only. It is not suitable for off-road use.

Protective apparel

The majority of fatalities from scooter accidents are the result of head injuries. The use of a safety helmet is the single most critical factor in the prevention or reduction of head injuries.

- Always obey the speed limit and never travel faster than warranted by road and traffic conditions.
- Always signal before turning or changing lanes. Make sure that other motorists can see you.
- The posture of the operator and passenger is important for proper control.
 - The operator should keep both hands on the handlebar and both feet on the operator footrests during operation to maintain control of the scooter.
 - The passenger should always hold onto the operator, the seat strap or grab bar, if equipped, with both hands and keep both feet on the passenger footrests. Never carry a passenger unless he or she can firmly place both feet on the passenger footrests.
- Always wear an approved helmet.
- Wear a face shield or goggles. Wind in your unprotected eyes could contribute to an impairment of vision that could delay seeing a hazard.
- The use of a jacket, substantial shoes, trousers, gloves, etc., is effective in preventing or reducing abrasions or lacerations.
- Never wear loose-fitting clothes, otherwise they could catch on the control levers or wheels and cause injury or an accident.

- Always wear protective clothing that covers your legs, ankles, and feet. The engine or exhaust system become very hot during or after operation and can cause burns.
- A passenger should also observe the above precautions.

Avoid Carbon Monoxide Poisoning

All engine exhaust contains carbon monoxide, a deadly gas. Breathing carbon monoxide can cause headaches, dizziness, drowsiness, nausea, confusion, and eventually death.

Carbon Monoxide is a colorless, odorless, tasteless gas which may be present even if you do not see or smell any engine exhaust. Deadly levels of carbon monoxide can collect rapidly and you can quickly be overcome and unable to save yourself. Also, deadly levels of carbon monoxide can linger for hours or days in enclosed or poorly ventilated areas. If you experience any symptoms of carbon monoxide poisoning, leave the area immediately, get fresh air, and **SEEK MEDICAL TREATMENT**.

- Do not run engine indoors. Even if you try to ventilate engine exhaust with fans or open windows and doors, carbon monoxide can rapidly reach dangerous levels.
- Do not run engine in poorly ventilated or partially enclosed areas such as barns, garages, or carports.
- Do not run engine outdoors where engine exhaust can be drawn into a building through openings such as windows and doors.

Loading

Adding accessories or cargo to your scooter can adversely affect stability and handling if the weight distribution of the scooter is changed. To avoid the possibility of an accident, use extreme caution when adding cargo or accessories to your scooter. Use extra care when riding a scooter that has added cargo or accessories. Here, along with the information about accessories below, are some general guidelines to follow if loading cargo to your scooter:

The total weight of the operator, passenger, accessories and cargo must not exceed the maximum load limit.

Operation of an overloaded vehicle could cause an accident.

Maximum load:
180 kg (397 lb)

When loading within this weight limit, keep the following in mind:

- Cargo and accessory weight should be kept as low and close to the scooter as possible. Securely pack your heaviest items as close to the center of the vehicle as possible and make sure to distribute the weight as evenly as possible on both sides of the scooter to minimize imbalance or instability.
- Shifting weights can create a sudden imbalance. Make sure that accessories and cargo are securely

attached to the scooter before riding. Check accessory mounts and cargo restraints frequently.

- Properly adjust the suspension for your load (suspension-adjustable models only), and check the condition and pressure of your tires.
- Never attach any large or heavy items to the handlebar, front fork, or front fender. Such items can create unstable handling or a slow steering response.
- **This vehicle is not designed to pull a trailer or to be attached to a sidecar.**

Genuine Yamaha Accessories

Choosing accessories for your vehicle is an important decision. Genuine Yamaha accessories, which are available only from a Yamaha dealer, have been designed, tested, and approved by Yamaha for use on your vehicle.

Many companies with no connection to Yamaha manufacture parts and accessories or offer other modifications for Yamaha vehicles. Yamaha is not in a position to test the products that these

SAFETY INFORMATION

1 aftermarket companies produce. Therefore, Yamaha can neither endorse nor recommend the use of accessories not sold by Yamaha or modifications not specifically recommended by Yamaha, even if sold and installed by a Yamaha dealer.

Aftermarket Parts, Accessories, and Modifications

While you may find aftermarket products similar in design and quality to genuine Yamaha accessories, recognize that some aftermarket accessories or modifications are not suitable because of potential safety hazards to you or others. Installing aftermarket products or having other modifications performed to your vehicle that change any of the vehicle's design or operation characteristics can put you and others at greater risk of serious injury or death. You are responsible for injuries related to changes in the vehicle.

Keep the following guidelines in mind, as well as those provided under "Loading" when mounting accessories.

- Never install accessories or carry cargo that would impair the performance of your scooter. Carefully inspect the accessory before using it to make sure that it does not in any way reduce ground clearance or cornering clearance, limit suspension travel, steering travel or control operation, or obscure lights or reflectors.
- Accessories fitted to the handlebar or the front fork area can create instability due to improper weight distribution or aerodynamic changes. If accessories are added to the handlebar or front fork area, they must be as lightweight as possible and should be kept to a minimum.
- Bulky or large accessories may seriously affect the stability of the scooter due to aerodynamic effects. Wind may attempt to lift the scooter, or the scooter may become unstable in cross winds. These accessories may also cause instability when passing or being passed by large vehicles.
- Certain accessories can displace the operator from his or her normal riding position. This improper position limits the freedom of movement of the operator and may limit control ability, therefore, such accessories are not recommended.
- Use caution when adding electrical accessories. If electrical accessories exceed the capacity of the scooter's electrical system, an electric failure could result, which could cause a dangerous loss of lights or engine power.

Aftermarket Tires and Rims

The tires and rims that came with your scooter were designed to match the performance capabilities and to provide the best combination of handling, braking, and comfort. Other tires, rims, sizes, and combinations may not be appropriate. Refer to page 6-12 for tire specifications and more information on replacing your tires.

EAU10372

Further safe-riding points

- Be sure to signal clearly when making turns.
 - Braking can be extremely difficult on a wet road. Avoid hard braking, because the scooter could slide. Apply the brakes slowly when stopping on a wet surface.
 - Slow down as you approach a corner or turn. Once you have completed a turn, accelerate slowly.
 - Be careful when passing parked cars. A driver might not see you and open a door in your path.
 - Railroad crossings, streetcar rails, iron plates on road construction sites, and manhole covers become extremely slippery when wet. Slow down and cross them with caution. Keep the scooter upright, otherwise it could slide out from under you.
 - The brake pads could get wet when you wash the scooter. After washing the scooter, check the brakes before riding.
- Always wear a helmet, gloves, trousers (tapered around the cuff and ankle so they do not flap), and a bright colored jacket.
 - Do not carry too much luggage on the scooter. An overloaded scooter is unstable. Use a strong cord to secure any luggage to the carrier (if equipped). A loose load will affect the stability of the scooter and could divert your attention from the road. (See page 1-1.)

DESCRIPTION

EAU10410

Left view

2

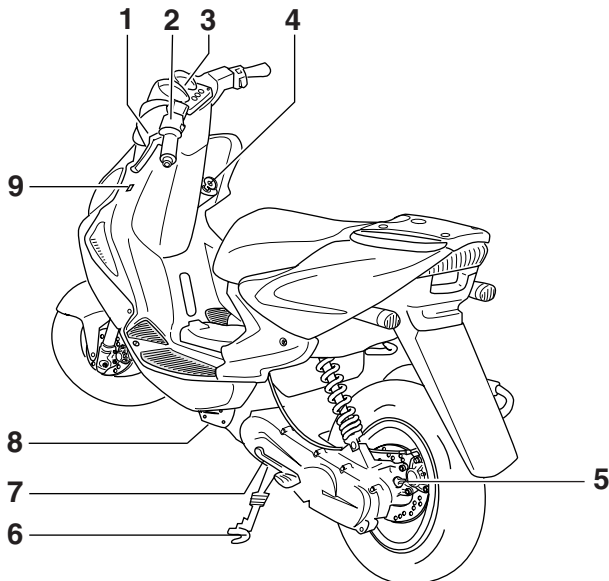

1. Rear brake lever (page 3-5)
2. Left handlebar switches (page 3-4)
3. Speedometer unit (page 3-3)
4. Main switch/steering lock (page 3-1)
5. Final transmission oil filler cap (page 6-8)
6. Centerstand (page 6-17)
7. Kickstarter (page 3-9)
8. Air filter element (page 6-10)

9. Coolant level check window (page 6-9)

Right view

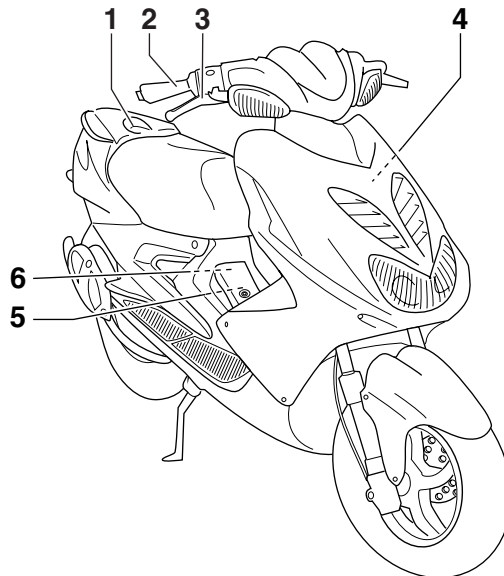

1. Fuel tank cap (page 3-5)
2. Throttle grip (page 6-11)
3. Front brake lever (page 3-5)
4. Coolant reservoir cap (page 6-9)
5. Battery/fuse (page 6-19/6-20)
6. Oil tank cap (page 3-8)

INSTRUMENT AND CONTROL FUNCTIONS

Main switch/steering lock

EAU10460

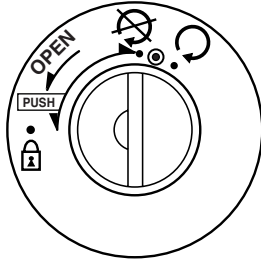

ZAUM0253

The main switch/steering lock controls the ignition and lighting systems, and is used to lock the steering. The various positions are described below.

ON “○”

EAU10640

All electrical circuits are supplied with power, and the engine can be started. The key cannot be removed.

TIP

The headlight, meter lighting and tail-light come on automatically when the engine is started.

OFF “⌘”

EAU10661

All electrical systems are off. The key can be removed.

⚠ WARNING

EWA10061

Never turn the key to “⌘” or “⌘” while the vehicle is moving. Otherwise the electrical systems will be switched off, which may result in loss of control or an accident.

CHECK “⊙”

EAU10670

The 2-stroke engine oil level warning light should come on. (See page 3-2.)

LOCK “⌘”

EAU10681

The steering is locked, and all electrical systems are off. The key can be removed.

To lock the steering

1. Turn the handlebars all the way to the left.
2. Push the key in from the “⌘” position, and then turn it to “⌘” while still pushing it.
3. Remove the key.

To unlock the steering

Push the key in, and then turn it to “⌘” while still pushing it.

Indicator and warning lights

EAU11003

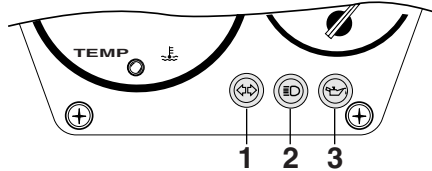

ZALUM0254

1. Turn signal indicator light “↔”
2. High beam indicator light “≡○”
3. Oil level warning light “🛢️”

Turn signal indicator light “↔”

EAU11020

This indicator light flashes when the turn signal switch is pushed to the left or right.

High beam indicator light “≡○”

EAU11080

This indicator light comes on when the high beam of the headlight is switched on.

Oil level warning light “🛢️”

EAU11181

This warning light comes on when the key is in the “🔑” position or if the oil level in the 2-stroke engine oil tank is low during operation. If the warning light comes on during operation, stop immediately and fill the oil tank with Yamalube 2 or equivalent 2-stroke engine oil of either JASO grade “FC” or ISO grades “EG-C” or “EG-D”. The warning light should go off after the 2-stroke engine oil tank has been refilled.

TIP

If the warning light does not come on when the key is in the “🔑” position or does not go off after the 2-stroke engine oil tank has been refilled, have a Yamaha dealer check the electrical circuit.

NOTICE

Do not operate the vehicle until you know that the engine oil level is sufficient.

Coolant temperature warning light “🌡️”

EAU11433

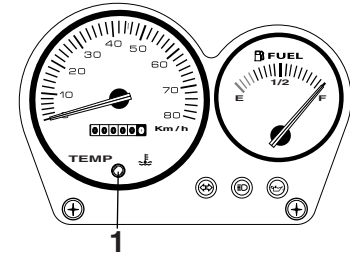

ZALUM0255

1. Coolant temperature warning light “🌡️”

This warning light comes on if the engine overheats. If this occurs, stop the engine immediately and allow the engine to cool.

NOTICE

Do not continue to operate the engine if it is overheating.

TIP

- For radiator-fan-equipped vehicles, the radiator fan(s) automatically switch on or off according to the coolant temperature in the radiator.

INSTRUMENT AND CONTROL FUNCTIONS

- If the engine overheats, see page 6-24 for further instructions.

3

Speedometer unit

EAUT1821

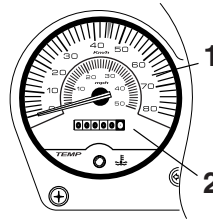

ZALM0801

1. Speedometer
2. Odometer

The speedometer unit is equipped with a speedometer and an odometer. The speedometer shows the riding speed. The odometer shows the total distance traveled.

Tachometer (if equipped)

EAU11851

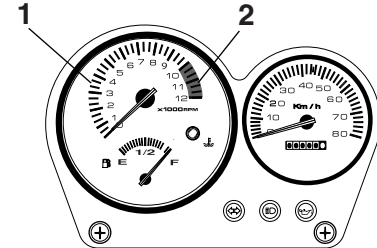

ZALM0292

1. Tachometer
2. Tachometer red zone

The electric tachometer allows the rider to monitor the engine speed and keep it within the ideal power range.

ECA10031

NOTICE

Do not operate the engine in the tachometer red zone.

Red zone: 10000 r/min and above

INSTRUMENT AND CONTROL FUNCTIONS

Fuel gauge

EAU12140

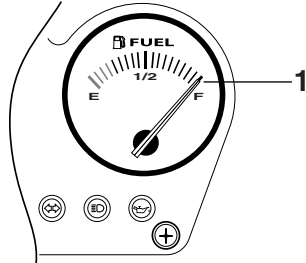

ZALUM0257

1. Fuel gauge

The fuel gauge indicates the amount of fuel in the fuel tank. The needle moves towards “E” (Empty) as the fuel level decreases. When the needle reaches “E”, refuel as soon as possible.

TIP

Do not allow the fuel tank to empty itself completely.



Handlebar switches

EAU12347

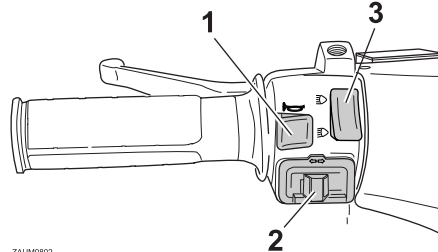
Left



ZALUM0802

1. Horn switch “”
2. Turn signal switch “”
3. Dimmer switch “”

Right

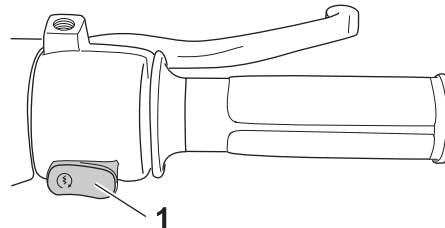



ZALUM0803

1. Start switch “”



Dimmer switch “”

EAU12400

Set this switch to “” for the high beam and to “” for the low beam.

Turn signal switch “”

EAU12460

To signal a right-hand turn, push this switch to “”. To signal a left-hand turn, push this switch to “”. When released, the switch returns to the center position. To cancel the turn signal lights, push the switch in after it has returned to the center position.

3

Horn switch “”

EAU12500

Press this switch to sound the horn.

Start switch “”

EAUM1132

Push this switch while applying the front or rear brake to crank the engine with the starter. See page 5-1 for starting instructions prior to starting the engine.

INSTRUMENT AND CONTROL FUNCTIONS

Front brake lever

EAU12900

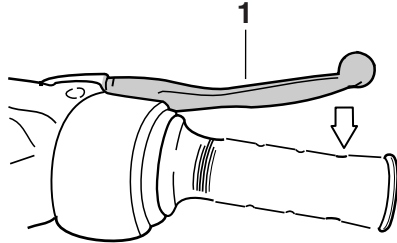

1. Front brake lever

The front brake lever is located on the right handlebar grip. To apply the front brake, pull this lever toward the handlebar grip.

Rear brake lever

EAU12950

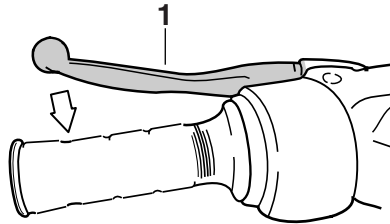

1. Rear brake lever

The rear brake lever is located on the left handlebar grip. To apply the rear brake, pull this lever toward the handlebar grip.

Fuel tank cap

EAU2081

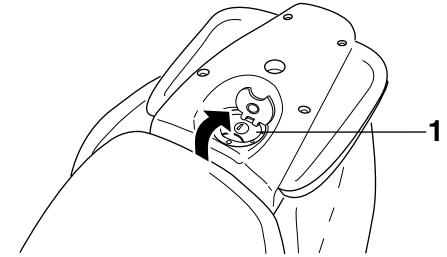

1. Fuel tank cap

To remove the fuel tank cap

1. Open the fuel tank cap lock cover.
2. Insert the key into the lock and turn it 1/4 turn counterclockwise. The lock will be released and the fuel tank cap can be removed.

To install the fuel tank cap

1. Push the fuel tank cap into position with the key inserted in the lock.
2. Turn the key clockwise to the original position, and then remove it.
3. Close the lock cover.

INSTRUMENT AND CONTROL FUNCTIONS

TIP _____

The fuel tank cap cannot be installed unless the key is in the lock. In addition, the key cannot be removed if the cap is not properly installed and locked.

WARNING _____

Make sure that the fuel tank cap is properly installed before riding. Leaking fuel is a fire hazard.

EWA11141

Fuel

Make sure there is sufficient gasoline in the tank.

WARNING _____

Gasoline and gasoline vapors are extremely flammable. To avoid fires and explosions and to reduce the risk of injury when refueling, follow these instructions.

1. Before refueling, turn off the engine and be sure that no one is sitting on the vehicle. Never refuel while smoking, or while in the vicinity of sparks, open flames, or other sources of ignition such as the pilot lights of water heaters and clothes dryers.
2. Do not overfill the fuel tank. Stop filling when the fuel reaches the bottom of the filler tube. Because fuel expands when it heats up, heat from the engine or the sun can cause fuel to spill out of the fuel tank.

EAU13212

EWA10881

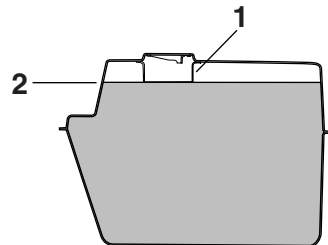

ZALU0020

1. Fuel tank filler tube
2. Fuel level
3. Wipe up any spilled fuel immediately. **NOTICE: Immediately wipe off spilled fuel with a clean, dry, soft cloth, since fuel may deteriorate painted surfaces or plastic parts.** [ECA10071]
4. Be sure to securely close the fuel tank cap.

WARNING _____

Gasoline is poisonous and can cause injury or death. Handle gasoline with care. Never siphon gasoline by mouth. If you should swallow some gasoline or inhale a lot of gasoline vapor, or get some gasoline in your eyes, see your doctor immedi-

EWA15151

INSTRUMENT AND CONTROL FUNCTIONS

ately. If gasoline spills on your skin, wash with soap and water. If gasoline spills on your clothing, change your clothes.

EAU41272

Recommended fuel:

Premium unleaded gasoline only

Fuel tank capacity:

7.0 L (1.85 US gal, 1.54 Imp.gal)

ECA11400

NOTICE

Use only unleaded gasoline. The use of leaded gasoline will cause severe damage to internal engine parts, such as the valves and piston rings, as well as to the exhaust system.

Your Yamaha engine has been designed to use premium unleaded gasoline with a pump octane number [(R+M)/2] of 91 or higher, or a research octane number of 95 or higher. If knocking (or pinging) occurs, use a gasoline of a different brand. Use of unleaded fuel will extend spark plug life and reduce maintenance costs.

Gasohol (for Canada)

There are two types of gasohol: gasohol containing ethanol and that containing methanol. Gasohol containing ethanol can be used if the ethanol content does not exceed 10%. Gasohol containing methanol is not recommended by Yamaha because it can cause damage to the fuel system or vehicle performance problems.

Catalytic converters

EAU13445

This vehicle is equipped with catalytic converters in the exhaust system.

EWA10862

WARNING

The exhaust system is hot after operation. To prevent a fire hazard or burns:

- Do not park the vehicle near possible fire hazards such as grass or other materials that easily burn.
- Park the vehicle in a place where pedestrians or children are not likely to touch the hot exhaust system.
- Make sure that the exhaust system has cooled down before doing any maintenance work.
- Do not allow the engine to idle more than a few minutes. Long idling can cause a build-up of heat.

INSTRUMENT AND CONTROL FUNCTIONS

NOTICE

Use only unleaded gasoline. The use of leaded gasoline will cause unrepairable damage to the catalytic converter.

ECA10701

EAUM2500

2-stroke engine oil

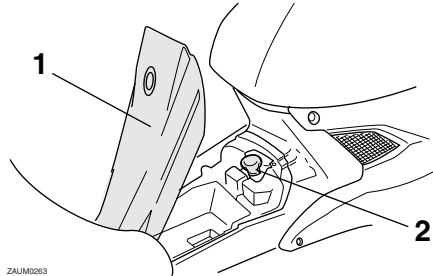

ZALUM0263

1. Storage compartment B
2. Oil tank cap

Make sure that there is sufficient 2-stroke engine oil in the oil tank. If necessary, add the recommended 2-stroke engine oil as follows.

1. Open the storage compartment. (See page 3-10.)
2. Remove the engine oil tank cap by pulling it off.
3. Fill the oil tank with the recommended 2-stroke engine oil, and then install the tank cap by pushing it into the filler hole.

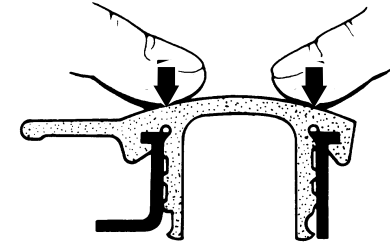

ZALUM0204

Recommended oil:

See page 8-1.

Oil quantity:

1.40 L (1.48 US qt, 1.23 Imp.qt)

TIP

Make sure that the 2-stroke engine oil tank cap is properly installed before riding the vehicle.

INSTRUMENT AND CONTROL FUNCTIONS

Kickstarter

EAUS1050

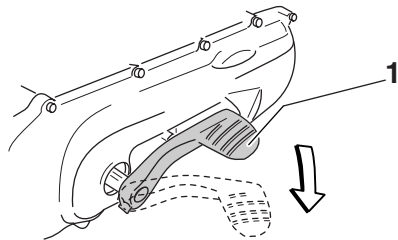

1. Kickstarter

To start the engine, push the kickstarter down lightly with your foot until the gears engage, and then push it down smoothly but forcefully.

ZALUM0146

Rider seat

EAU14160

To open the rider seat

1. Place the scooter on the center-stand.
2. Insert the key into the main switch, and then turn it counterclockwise.

TIP

Do not push inward when turning the key.

3. Fold the rider seat up.

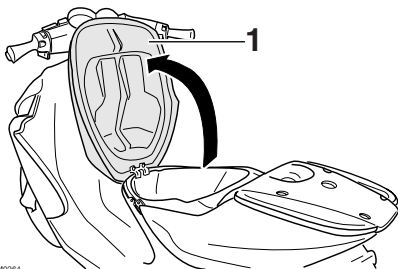

ZALUM0264

1. Seat

To close the rider seat

1. Fold the rider seat down, and then push it down to lock it in place.

2. Remove the key from the main switch if the scooter will be left unattended.

TIP

Make sure that the seat is properly secured before riding.

Storage compartments

EAM2530

This vehicle is equipped with two storage compartments.

Storage compartment A

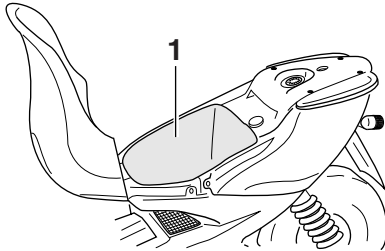

ZAJM0285

1. Storage compartment A

Storage compartment A is located under the rider seat. (See page 3-9.)

EWA10961

WARNING

- Do not exceed the load limit of 3 kg (7 lb) for the storage compartment.
- Do not exceed the maximum load of 180 kg (397 lb) for the vehicle.

NOTICE

Keep the following points in mind when using the storage compartment.

- Since the storage compartment accumulates heat when exposed to the sun, do not store anything susceptible to heat inside it.
- To avoid humidity from spreading through the storage compartment, wrap wet articles in a plastic bag before storing them in the compartment.
- Since the storage compartment may get wet while the scooter is being washed, wrap any articles stored in the compartment in a plastic bag.
- Do not keep anything valuable or breakable in the storage compartment.

To store a helmet in the storage compartment, place the helmet upside-down with the front facing forward.

ECA10080

TIP

- Some helmets cannot be stored in the storage compartment because of their size or shape.
- Do not leave your scooter unattended with the seat open.

Storage compartment B

Storage compartment B is located in front of the rider seat.

To open the storage compartment

1. Insert the key into the lock, and then turn it clockwise.

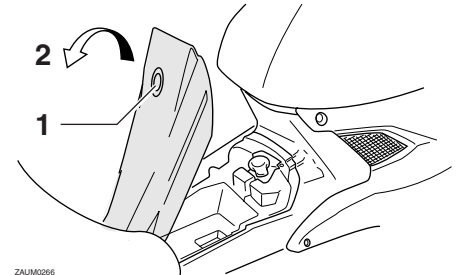

ZAJM0286

1. Storage compartment lock
2. Open.

2. Fold the storage compartment cover up.

INSTRUMENT AND CONTROL FUNCTIONS

To close the storage compartment

1. Fold the storage compartment cover down.
2. Turn the key counterclockwise, and then remove it.

3

Adjusting the shock absorber assembly (if equipped)

EAU14832

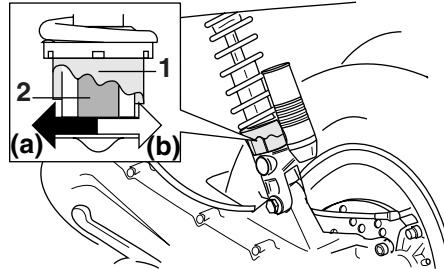

ZALUM0294

1. Spring preload adjusting ring
2. Position indicator

This shock absorber assembly is equipped with a spring preload adjusting ring.

ECA10101

NOTICE

To avoid damaging the mechanism, do not attempt to turn beyond the maximum or minimum settings.

Adjust the spring preload as follows. To increase the spring preload and thereby harden the suspension, turn the adjusting ring in direction (a). To de-

crease the spring preload and thereby soften the suspension, turn the adjusting ring in direction (b). Align the appropriate notch in the adjusting ring with the position indicator on the shock absorber.

Spring preload setting:

Minimum (soft):

(b)

Standard:

middle

Maximum (hard):

(a)

EWA10221

WARNING

This shock absorber assembly contains highly pressurized nitrogen gas. Read and understand the following information before handling the shock absorber assembly.

- Do not tamper with or attempt to open the cylinder assembly.
- Do not subject the shock absorber assembly to an open flame or other high heat source. This may cause the unit to explode due to excessive gas pressure.

INSTRUMENT AND CONTROL FUNCTIONS

- **Do not deform or damage the cylinder in any way. Cylinder damage will result in poor damping performance.**
 - **Do not dispose of a damaged or worn-out shock absorber assembly yourself. Take the shock absorber assembly to a Yamaha dealer for any service.**
-

FOR YOUR SAFETY – PRE-OPERATION CHECKS

EAU15596

Inspect your vehicle each time you use it to make sure the vehicle is in safe operating condition. Always follow the inspection and maintenance procedures and schedules described in the Owner's Manual.

EWA11151

WARNING

Failure to inspect or maintain the vehicle properly increases the possibility of an accident or equipment damage. Do not operate the vehicle if you find any problem. If a problem cannot be corrected by the procedures provided in this manual, have the vehicle inspected by a Yamaha dealer.

Before using this vehicle, check the following points:

ITEM	CHECKS	PAGE
Fuel	<ul style="list-style-type: none">• Check fuel level in fuel tank.• Refuel if necessary.• Check fuel line for leakage.	3-6
2-stroke engine oil	<ul style="list-style-type: none">• Check oil level in oil tank.• If necessary, add recommended oil to specified level.• Check vehicle for oil leakage.	3-8
Final transmission oil	<ul style="list-style-type: none">• Check vehicle for oil leakage.	6-8
Coolant	<ul style="list-style-type: none">• Check coolant level in reservoir.• If necessary, add recommended coolant to specified level.• Check cooling system for leakage.	6-9
Front brake	<ul style="list-style-type: none">• Check operation.• If soft or spongy, have Yamaha dealer bleed hydraulic system.• Check brake pads for wear.• Replace if necessary.• Check fluid level in reservoir.• If necessary, add recommended brake fluid to specified level.• Check hydraulic system for leakage.	6-14, 6-14, 6-15

FOR YOUR SAFETY – PRE-OPERATION CHECKS

ITEM	CHECKS	PAGE
Rear brake	<ul style="list-style-type: none"> • Check operation. • If soft or spongy, have Yamaha dealer bleed hydraulic system. • Check brake pads for wear. • Replace if necessary. • Check fluid level in reservoir. • If necessary, add recommended brake fluid to specified level. • Check hydraulic system for leakage. 	6-14, 6-14, 6-15
Throttle grip	<ul style="list-style-type: none"> • Make sure that operation is smooth. • Check cable free play. • If necessary, have Yamaha dealer adjust cable free play and lubricate cable and grip housing. 	6-11, 6-16
Wheels and tires	<ul style="list-style-type: none"> • Check for damage. • Check tire condition and tread depth. • Check air pressure. • Correct if necessary. 	6-12, 6-13
Brake levers	<ul style="list-style-type: none"> • Make sure that operation is smooth. • Lubricate lever pivoting points if necessary. 	6-16
Centerstand	<ul style="list-style-type: none"> • Make sure that operation is smooth. • Lubricate pivot if necessary. 	6-17
Chassis fasteners	<ul style="list-style-type: none"> • Make sure that all nuts, bolts and screws are properly tightened. • Tighten if necessary. 	—
Instruments, lights, signals and switches	<ul style="list-style-type: none"> • Check operation. • Correct if necessary. 	—
Battery	<ul style="list-style-type: none"> • Check fluid level. • Fill with distilled water if necessary. 	6-19

OPERATION AND IMPORTANT RIDING POINTS

EAU15951

Read the Owner's Manual carefully to become familiar with all controls. If there is a control or function you do not understand, ask your Yamaha dealer.

EWA10271

WARNING

Failure to familiarize yourself with the controls can lead to loss of control, which could cause an accident or injury.

5

EAU16562

ECA10250

Starting a cold engine

NOTICE

See page 5-3 for engine break-in instructions prior to operating the vehicle for the first time.

1. Turn the key to "⊙", and when the oil level warning light comes on, turn it to "○".

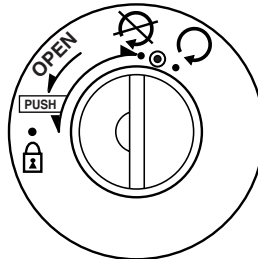

ZAJM0253

ECA10240

NOTICE

If the oil level warning light does not come on, have a Yamaha dealer check the electrical circuit.

2. Close the throttle completely.

3. While applying the front or rear brake, start the engine by pushing the start switch or by pushing the kickstarter lever down. **NOTICE:** For maximum engine life, never accelerate hard when the engine is cold! [ECA11041]

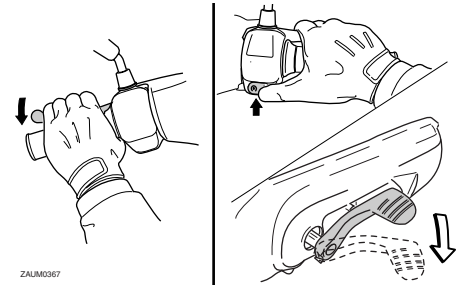

ZAJM0367

If the engine fails to start by pushing the start switch, release the switch, wait a few seconds, and then try again. Each starting attempt should be as short as possible to preserve the battery. Do not crank the engine more than 5 seconds on any one attempt. If the engine does not start with the starter motor, try using the kickstarter.

OPERATION AND IMPORTANT RIDING POINTS

Starting off

EAU16761

TIP

Before starting off, allow the engine to warm up.

1. While pulling the rear brake lever with your left hand and holding the grab bar with your right hand, push the scooter off the centerstand.

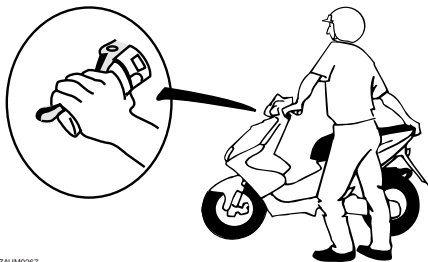

ZALUM0267

2. Sit astride the seat, and then adjust the rear view mirrors.
3. Switch the turn signals on.
4. Check for oncoming traffic, and then slowly turn the throttle grip (on the right) in order to take off.
5. Switch the turn signals off.

Acceleration and deceleration

EAU16780

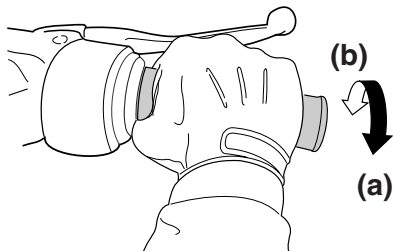

ZALUM0199

The speed can be adjusted by opening and closing the throttle. To increase the speed, turn the throttle grip in direction (a). To reduce the speed, turn the throttle grip in direction (b).

Braking

EAU16793

EWA10300

⚠ WARNING

- Avoid braking hard or suddenly (especially when leaning over to one side), otherwise the scooter may skid or overturn.
 - Railroad crossings, streetcar rails, iron plates on road construction sites, and manhole covers become extremely slippery when wet. Therefore, slow down when approaching such areas and cross them with caution.
 - Keep in mind that braking on a wet road is much more difficult.
 - Ride slowly down a hill, as braking downhill can be very difficult.
1. Close the throttle completely.
 2. Apply both front and rear brakes simultaneously while gradually increasing the pressure.

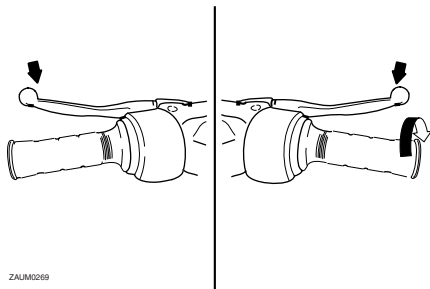

ZALUM0269

EAU16820

Tips for reducing fuel consumption

Fuel consumption depends largely on your riding style. Consider the following tips to reduce fuel consumption:

- Avoid high engine speeds during acceleration.
- Avoid high engine speeds with no load on the engine.
- Turn the engine off instead of letting it idle for an extended length of time (e.g., in traffic jams, at traffic lights or at railroad crossings).

EAU16830

Engine break-in

There is never a more important period in the life of your engine than the period between 0 and 1000 km (600 mi). For this reason, you should read the following material carefully.

Since the engine is brand new, do not put an excessive load on it for the first 1000 km (600 mi). The various parts in the engine wear and polish themselves to the correct operating clearances. During this period, prolonged full-throttle operation or any condition that might result in engine overheating must be avoided.

EAUM2091

0–150 km (0–90 mi)

Avoid prolonged operation above 1/3 throttle. Vary the speed of the scooter from time to time. Do not operate it at one set throttle position.

150–500 km (90–300 mi)

Avoid prolonged operation above 1/2 throttle.

500–1000 km (300–600 mi)

Avoid cruising speeds in excess of 3/4 throttle.

OPERATION AND IMPORTANT RIDING POINTS

1000 km (600 mi) and beyond

Avoid prolonged full throttle operation. Vary speeds occasionally. **NOTICE:** After 1000 km (600 mi) of operation, the final transmission oil must be changed. [ECAM1071]

ECA10270

NOTICE

If any engine trouble should occur during the engine break-in period, immediately have a Yamaha dealer check the vehicle.

EAU17213

Parking

When parking, stop the engine, and then remove the key from the main switch.

EWA10311

WARNING

- Since the engine and exhaust system can become very hot, park in a place where pedestrians or children are not likely to touch them and be burned.
 - Do not park on a slope or on soft ground, otherwise the vehicle may overturn, increasing the risk of a fuel leak and fire.
 - Do not park near grass or other flammable materials which might catch fire.
-

PERIODIC MAINTENANCE AND ADJUSTMENT

EAU17281

EWA15121

Periodic inspection, adjustment, and lubrication will keep your vehicle in the safest and most efficient condition possible. Safety is an obligation of the vehicle owner/operator. The most important points of vehicle inspection, adjustment, and lubrication are explained on the following pages.

The intervals given in the periodic maintenance and lubrication chart should be simply considered as a general guide under normal riding conditions. However, depending on the weather, terrain, geographical location, and individual use, the maintenance intervals may need to be shortened.

EWA10321

WARNING

Failure to properly maintain the vehicle or performing maintenance activities incorrectly may increase your risk of injury or death during service or while using the vehicle. If you are not familiar with vehicle service, have a Yamaha dealer perform service.

WARNING

Turn off the engine when performing maintenance unless otherwise specified.

- **A running engine has moving parts that can catch on body parts or clothing and electrical parts that can cause shocks or fires.**
- **Running the engine while servicing can lead to eye injury, burns, fire, or carbon monoxide poisoning – possibly leading to death. See page 1-1 for more information about carbon monoxide.**

EWA10330

WARNING

This scooter is designed for use on paved roads only. If this scooter is operated in abnormally dusty, muddy or wet conditions, the air filter element should be cleaned or replaced more frequently, otherwise rapid engine wear may result. Consult a Yamaha dealer for proper maintenance intervals.

PERIODIC MAINTENANCE AND ADJUSTMENT

EAU17715

Periodic maintenance and lubrication chart

TIP

- The annual checks must be performed every year, except if a kilometer-based maintenance, or for the UK, a mileage-based maintenance, is performed instead.
- From 30000 km (17500 mi), repeat the maintenance intervals starting from 6000 km (3500 mi).
- Items marked with an asterisk should be performed by a Yamaha dealer as they require special tools, data and technical skills.

NO.	ITEM	CHECK OR MAINTENANCE JOB	ODOMETER READING					ANNUAL CHECK
			1000 km (600 mi)	6000 km (3500 mi)	12000 km (7000 mi)	18000 km (10500 mi)	24000 km (14000 mi)	
1	* Fuel line	• Check fuel and vacuum hoses for cracks or damage.		√	√	√	√	√
2	Spark plug	• Replace.		√	√	√	√	√
3	Air filter element	• Clean.		√		√		
		• Replace.			√		√	
4	* Battery	• Check electrolyte level and specific gravity. • Make sure that the breather hose is properly routed.		√	√	√	√	√
5	* Front brake	• Check operation, fluid level and vehicle for fluid leakage.	√	√	√	√	√	√
		• Replace brake pads.	Whenever worn to the limit					
6	* Rear brake	• Check operation, fluid level and vehicle for fluid leakage.	√	√	√	√	√	√
		• Replace brake pads.	Whenever worn to the limit					

PERIODIC MAINTENANCE AND ADJUSTMENT

NO.	ITEM	CHECK OR MAINTENANCE JOB	ODOMETER READING					ANNUAL CHECK
			1000 km (600 mi)	6000 km (3500 mi)	12000 km (7000 mi)	18000 km (10500 mi)	24000 km (14000 mi)	
7	* Brake hoses	• Check for cracks or damage.		√	√	√	√	√
		• Replace.	Every 4 years					
8	* Wheels	• Check runout and for damage.		√	√	√	√	
9	* Tires	• Check tread depth and for damage. • Replace if necessary. • Check air pressure. • Correct if necessary.		√	√	√	√	√
10	* Wheel bearings	• Check bearing for looseness or damage.		√	√	√	√	
11	* Steering bearings	• Check bearing play and steering for roughness.	√	√	√	√	√	
		• Lubricate with lithium-soap-based grease.	Every 24000 km (14000 mi)					
12	* Chassis fasteners	• Make sure that all nuts, bolts and screws are properly tightened.		√	√	√	√	√
13	Front brake lever pivot shaft	• Lubricate with silicone grease.		√	√	√	√	√
14	Rear brake lever pivot shaft	• Lubricate with silicone grease.		√	√	√	√	√
15	Centerstand	• Check operation. • Lubricate.		√	√	√	√	√
16	* Front fork	• Check operation and for oil leakage.		√	√	√	√	
17	* Shock absorber assembly	• Check operation and shock absorber for oil leakage.		√	√	√	√	

PERIODIC MAINTENANCE AND ADJUSTMENT

NO.	ITEM	CHECK OR MAINTENANCE JOB	ODOMETER READING					ANNUAL CHECK
			1000 km (600 mi)	6000 km (3500 mi)	12000 km (7000 mi)	18000 km (10500 mi)	24000 km (14000 mi)	
18	* Carburetor	• Adjust engine idling speed.	√	√	√	√	√	√
19	* Autolube pump	• Check operation. • Bleed if necessary.	√		√		√	√
20	* Cooling system	• Check coolant level and vehicle for coolant leakage.		√	√	√	√	√
		• Change.	Every 3 years					
21	Final transmission oil	• Check vehicle for oil leakage.	√	√		√		
		• Change.	√		√		√	
22	* V-belt	• Replace.	Every 10000 km (6000 mi)					
23	* Front and rear brake switches	• Check operation.	√	√	√	√	√	√
24	Moving parts and cables	• Lubricate.		√	√	√	√	√
25	* Throttle grip housing and cable	• Check operation and free play. • Adjust the throttle cable free play if necessary. • Lubricate the throttle grip housing and cable.		√	√	√	√	√
26	* Lights, signals and switches	• Check operation. • Adjust headlight beam.	√	√	√	√	√	√

TIP _____

- The air filter needs more frequent service if you are riding in unusually wet or dusty areas.

PERIODIC MAINTENANCE AND ADJUSTMENT

- Hydraulic brake service
 - Regularly check and, if necessary, correct the brake fluid level.
 - Every two years change the brake fluid.
 - Replace the brake hoses every four years and if cracked or damaged.
-

PERIODIC MAINTENANCE AND ADJUSTMENT

Removing and installing the cowling and panel

EAU18740

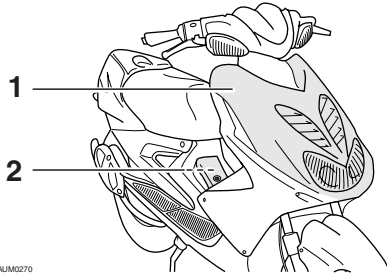

ZAJUM0270

1. Cowling A
2. Panel A

The cowling and panel shown above need to be removed to perform some of the maintenance jobs described in this chapter. Refer to this section each time a cowling or panel needs to be removed and installed.

Cowling A

EAU18790

To remove the cowling

Remove the screws, and then take the cowling off.

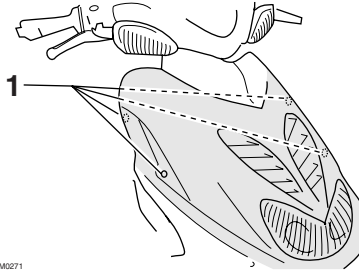

ZAJUM0271

1. Screw

To install the cowling

Place the cowling in the original position, and then install the screws.

Panel A

EAUM1250

To remove the panel

1. Open the storage compartment. (See page 3-10.)
2. Remove the screw, and then take the panel off.

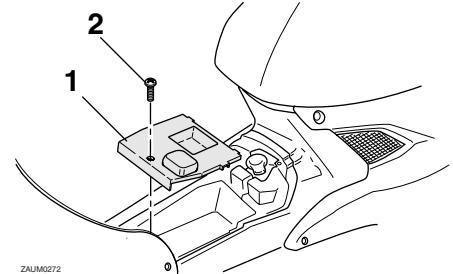

ZAJUM0272

1. Panel A
2. Screw

To install the panel

1. Place the panel in the original position, and then install the screw.
2. Close the storage compartment.

PERIODIC MAINTENANCE AND ADJUSTMENT

EAU19622

Checking the spark plug

The spark plug is an important engine component, which should be checked periodically, preferably by a Yamaha dealer. Since heat and deposits will cause any spark plug to slowly erode, it should be removed and checked in accordance with the periodic maintenance and lubrication chart. In addition, the condition of the spark plug can reveal the condition of the engine.

The porcelain insulator around the center electrode of the spark plug should be a medium-to-light tan (the ideal color when the vehicle is ridden normally). If the spark plug shows a distinctly different color, the engine could be operating improperly. Do not attempt to diagnose such problems yourself. Instead, have a Yamaha dealer check the vehicle. If the spark plug shows signs of electrode erosion and excessive carbon or other deposits, it should be replaced.

Specified spark plug:
NGK/BR8HS

Before installing a spark plug, the spark plug gap should be measured with a wire thickness gauge and, if necessary, adjusted to specification.

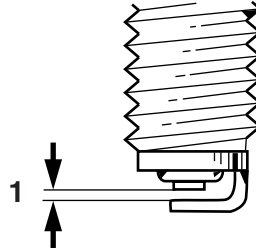

ZALJ00037

1. Spark plug gap

Spark plug gap:
0.6–0.7 mm (0.024–0.028 in)

Clean the surface of the spark plug gasket and its mating surface, and then wipe off any grime from the spark plug threads.

Tightening torque:
Spark plug:
20 Nm (2.0 m·kgf, 14 ft·lbf)

TIP

If a torque wrench is not available when installing a spark plug, a good estimate of the correct torque is 1/4–1/2 turn past finger tight. However, the spark plug should be tightened to the specified torque as soon as possible.

PERIODIC MAINTENANCE AND ADJUSTMENT

EAU20064

Final transmission oil

The final transmission case must be checked for oil leakage before each ride. If any leakage is found, have a Yamaha dealer check and repair the scooter. In addition, the final transmission oil must be changed as follows at the intervals specified in the periodic maintenance and lubrication chart.

1. Start the engine, warm up the final transmission oil by riding the scooter for several minutes, and then stop the engine.
2. Place the scooter on the center-stand.
3. Place an oil pan under the final transmission case to collect the used oil.
4. Remove the final transmission oil filler cap and final transmission drain bolt to drain the oil from the final transmission case.

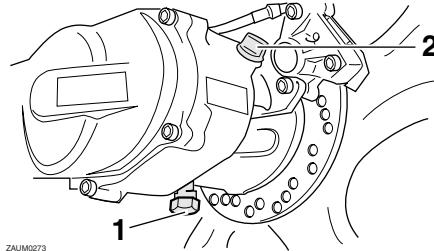

1. Final transmission oil drain bolt
2. Final transmission oil filler cap

5. Install the final transmission oil drain bolt, and then tighten it to the specified torque.

Tightening torque:

Final transmission oil drain bolt:
18 Nm (1.8 m·kgf, 13 ft·lbf)

6. Refill with the specified amount of the recommended final transmission oil, and then install and tighten the oil filler cap. **WARNING! Make sure that no foreign material enters the final transmission case. Make sure that no oil gets on the tire or wheel.** [EWA11311]

Recommended final transmission oil:

See page 8-1.

Oil quantity:

0.11 L (0.12 US qt, 0.10 Imp.qt)

7. Check the final transmission case for oil leakage. If oil is leaking, check for the cause.

PERIODIC MAINTENANCE AND ADJUSTMENT

Coolant

EAU20070

The coolant level should be checked before each ride. In addition, the coolant must be changed at the intervals specified in the periodic maintenance and lubrication chart.

EAUM2102

To check the coolant level

1. Place the vehicle on a level surface and hold it in an upright position.

TIP

- The coolant level must be checked on a cold engine since the level varies with engine temperature.
- Make sure that the vehicle is positioned straight up when checking the coolant level. A slight tilt to the side can result in a false reading.

2. Check the coolant level through the check window.

TIP

The coolant should be between the minimum and maximum level marks.

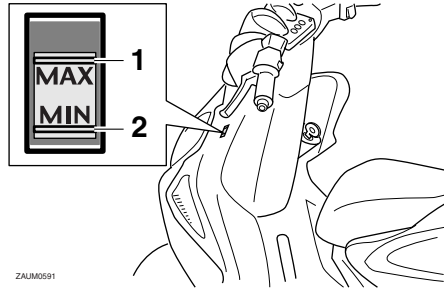

- ZAJUM0591
1. Maximum level mark
 2. Minimum level mark

3. If the coolant is at or below the minimum level mark, remove the cowl A. (See page 6-6.)
4. Open the reservoir cap, and then add coolant to the maximum level mark. **WARNING! Remove only the coolant reservoir cap. Never attempt to remove the radiator cap when the engine is hot.**

[EWA15161] **NOTICE:** If coolant is not available, use distilled water or soft tap water instead. Do not use hard water or salt water since it is harmful to the engine. If water has been used instead of coolant, replace it with coolant as soon as possible, other-

wise the cooling system will not be protected against frost and corrosion. If water has been added to the coolant, have a Yamaha dealer check the anti-freeze content of the coolant as soon as possible, otherwise the effectiveness of the coolant will be reduced. [ECA110472]

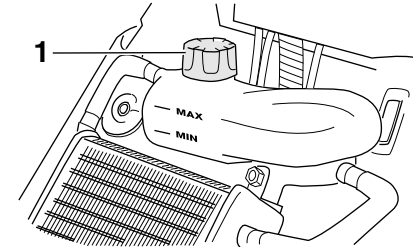

ZAJUM0274

1. Coolant reservoir cap

Coolant reservoir capacity:
0.25 L (0.26 US qt, 0.22 Imp.qt)

5. Close the reservoir cap, and then install the cowl.

PERIODIC MAINTENANCE AND ADJUSTMENT

Changing the coolant

The coolant must be changed at the intervals specified in the periodic maintenance and lubrication chart. Have a Yamaha dealer change the coolant.

WARNING! Never attempt to remove the radiator cap when the engine is hot. [EWA10381]

EAU33031

Cleaning the air filter element

The air filter element should be cleaned at the intervals specified in the periodic maintenance and lubrication chart. Clean the air filter element more frequently if you are riding in unusually wet or dusty areas.

1. Remove the air filter case cover by removing the screws.

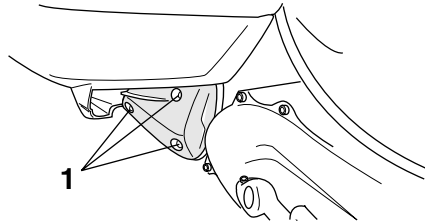

ZAJM0275

1. Screw

2. Pull the air filter element out, clean it with solvent, and then squeeze the remaining solvent out.
WARNING! Use only a dedicated parts cleaning solvent. To avoid the risk of fire or explosion, do not use gasoline or solvents with a low flash point.

EAUM1642

[EWA10431] **NOTICE:** To avoid damaging the foam material, handle it gently and carefully, and do not twist or wring it. [ECA10511]

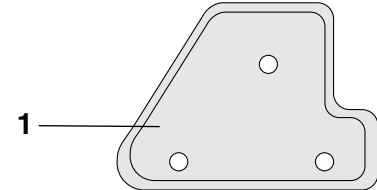

ZAJM0276

1. Air filter element

3. Apply oil of the recommended type to the entire surface of the element, and then squeeze the excess oil out.

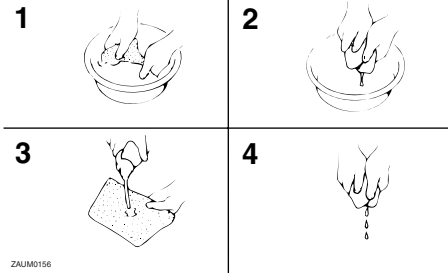

ZAJM0156

PERIODIC MAINTENANCE AND ADJUSTMENT

TIP _____

The air filter element should be wet but not dripping.

Recommended oil:

Foam air filter oil

4. Insert the element into the air filter case. **NOTICE: Make sure that the air filter element is properly seated in the air filter case. The engine should never be operated without the air filter element installed, otherwise the piston(s) and/or cylinder(s) may become excessively worn.**

[ECA10481]

5. Install the air filter case cover by installing the screws.

Adjusting the carburetor

EAU21300

The carburetor is an important part of the engine and requires very sophisticated adjustment. Therefore, all carburetor adjustments should be left to a Yamaha dealer, who has the necessary professional knowledge and experience.

Checking the throttle cable free play

EAU21382

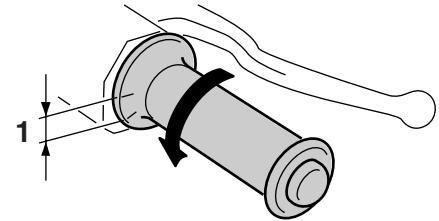

ZALM0051

1. Throttle cable free play

The throttle cable free play should measure 1.5–3.0 mm (0.06–0.12 in) at the throttle grip. Periodically check the throttle cable free play and, if necessary, have a Yamaha dealer adjust it.

PERIODIC MAINTENANCE AND ADJUSTMENT

EAU21872

Tires

To maximize the performance, durability, and safe operation of your vehicle, note the following points regarding the specified tires.

Tire air pressure

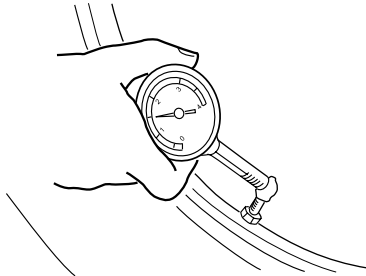

ZAJUM0053

The tire air pressure should be checked and, if necessary, adjusted before each ride.

EWA10501



WARNING

Operation of this vehicle with improper tire pressure may cause severe injury or death from loss of control.

- The tire air pressure must be checked and adjusted on cold tires (i.e., when the temperature of the tires equals the ambient temperature).
- The tire air pressure must be adjusted in accordance with the riding speed and with the total weight of rider, passenger, cargo, and accessories approved for this model.

Tire air pressure (measured on cold tires):

0–90 kg (0–198 lb):

Front:

150 kPa (1.50 kgf/cm², 22 psi)

Rear:

150 kPa (1.50 kgf/cm², 22 psi)

90–180 kg (198–397 lb):

Front:

160 kPa (1.60 kgf/cm², 23 psi)

Rear:

170 kPa (1.70 kgf/cm², 25 psi)

Maximum load*:

180 kg (397 lb)

* Total weight of rider, passenger, cargo and accessories

EWA10511



WARNING

Never overload your vehicle. Operation of an overloaded vehicle could cause an accident.

Tire inspection

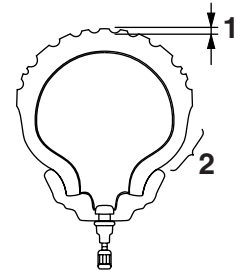

ZAJUM0054

1. Tire tread depth
2. Tire sidewall

The tires must be checked before each ride. If the center tread depth reaches the specified limit, if the tire has a nail or glass fragments in it, or if the sidewall is cracked, have a Yamaha dealer replace the tire immediately.

Minimum tire tread depth (front and rear):

1.6 mm (0.06 in)

PERIODIC MAINTENANCE AND ADJUSTMENT

EWA10470

EAU21960

TIP _____

The tire tread depth limits may differ from country to country. Always comply with the local regulations.

Tire information

This model is equipped with tubeless tires.

After extensive tests, only the tires listed below have been approved for this model by Yamaha Motor Co., Ltd.

Front tire:

Size:

130/60-13 53L (MICHELIN), 53P (PIRELLI)

Manufacturer/model:

MICHELIN / PILOT SPORT
PIRELLI / EVO21

Rear tire:

Size:

140/60-13 57L (MICHELIN), 53P (PIRELLI)

Manufacturer/model:

MICHELIN / PILOT SPORT
PIRELLI / EVO22

WARNING _____

- **Have a Yamaha dealer replace excessively worn tires. Besides being illegal, operating the vehicle with excessively worn tires decreases riding stability and can lead to loss of control.**
- **The replacement of all wheel and brake related parts, including the tires, should be left to a Yamaha dealer, who has the necessary professional knowledge and experience.**

Cast wheels

To maximize the performance, durability, and safe operation of your vehicle, note the following points regarding the specified wheels.

- The wheel rims should be checked for cracks, bends or warpage before each ride. If any damage is found, have a Yamaha dealer replace the wheel. Do not attempt even the smallest repair to the wheel. A deformed or cracked wheel must be replaced.
- The wheel should be balanced whenever either the tire or wheel has been changed or replaced. An unbalanced wheel can result in poor performance, adverse handling characteristics, and a shortened tire life.
- Ride at moderate speeds after changing a tire since the tire surface must first be “broken in” for it to develop its optimal characteristics.

PERIODIC MAINTENANCE AND ADJUSTMENT

Checking the front and rear brake lever free play

EAM2061

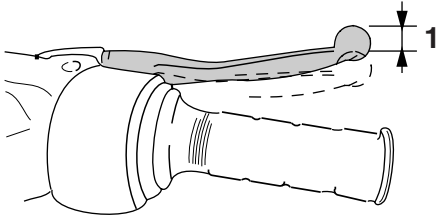

ZAJM0107

1. Front brake lever free play

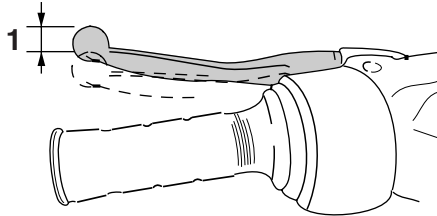

ZAJM0108

1. Rear brake lever free play

The brake lever free play should measure 10.0–20.0 mm (0.39–0.79 in) as shown. Periodically check the brake le-

ver free play and, if necessary, have a Yamaha dealer check the brake system.

EWA10641

! WARNING

An incorrect brake lever free play indicates a hazardous condition in the brake system. Do not operate the vehicle until the brake system has been checked or repaired by a Yamaha dealer.

Checking the front and rear brake pads

EAU22390

The front and rear brake pads must be checked for wear at the intervals specified in the periodic maintenance and lubrication chart.

Front brake pads

EAU22400

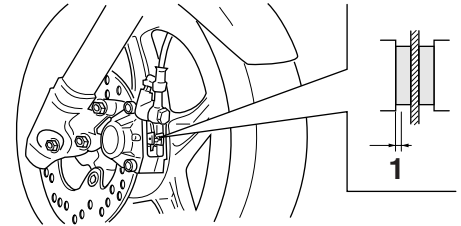

ZAJM0068

1. Lining thickness

Check each front brake pad for damage and measure the lining thickness. If a brake pad is damaged or if the lining thickness is less than 2 mm (0.08 in), have a Yamaha dealer replace the brake pads as a set.

PERIODIC MAINTENANCE AND ADJUSTMENT

Rear brake pads

EAU22500

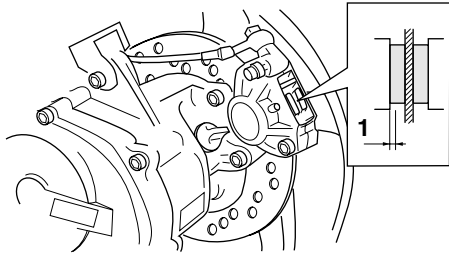

ZAJUM0278

1. Lining thickness

Check each rear brake pad for damage and measure the lining thickness. If a brake pad is damaged or if the lining thickness is less than 2 mm (0.08 in), have a Yamaha dealer replace the brake pads as a set.

Checking the brake fluid level

EAU22580

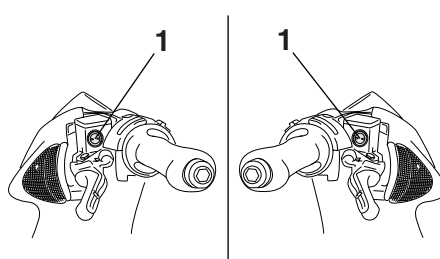

ZAJUM0280

1. Minimum level mark

Insufficient brake fluid may allow air to enter the brake system, possibly causing it to become ineffective. Before riding, check that the brake fluid is above the minimum level mark and replenish if necessary. A low brake fluid level may indicate worn brake pads and/or brake system leakage. If the brake fluid level is low, be sure to check the brake pads for wear and the brake system for leakage.

Observe these precautions:

- When checking the fluid level, make sure that the top of the brake fluid reservoir is level.

- Use only the recommended quality brake fluid, otherwise the rubber seals may deteriorate, causing leakage and poor braking performance.

Recommended brake fluid:
DOT 4

- Refill with the same type of brake fluid. Mixing fluids may result in a harmful chemical reaction and lead to poor braking performance.
- Be careful that water does not enter the brake fluid reservoir when refilling. Water will significantly lower the boiling point of the fluid and may result in vapor lock.
- Brake fluid may deteriorate painted surfaces or plastic parts. Always clean up spilled fluid immediately.
- As the brake pads wear, it is normal for the brake fluid level to gradually go down. However, if the brake fluid level goes down suddenly, have a Yamaha dealer check the cause.

PERIODIC MAINTENANCE AND ADJUSTMENT

Changing the brake fluid

EAUM1360

Have a Yamaha dealer change the brake fluid at the intervals specified in the periodic maintenance and lubrication chart. In addition, have the brake hose replaced every four years or whenever it is damaged or leaking.

Checking and lubricating the throttle grip and cable

EAU23111

The operation of the throttle grip should be checked before each ride. In addition, the cable should be lubricated at the intervals specified in the periodic maintenance chart.

Lubricating the front and rear brake levers

EAU23172

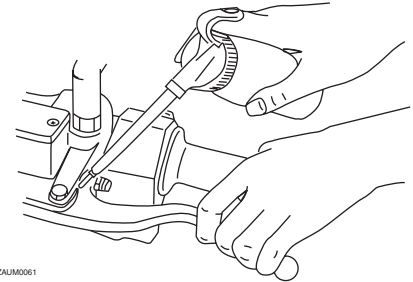

ZALM0061

The pivoting points of the front and rear brake levers must be lubricated at the intervals specified in the periodic maintenance and lubrication chart.

Recommended lubricant:
Silicone grease

PERIODIC MAINTENANCE AND ADJUSTMENT

Checking and lubricating the centerstand

EAU23192

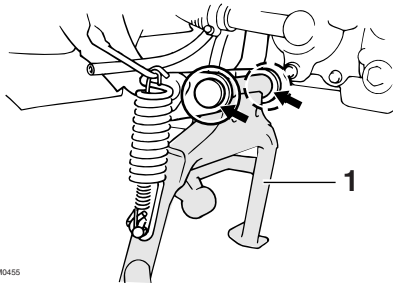

ZAUM0455

1. Centerstand

The operation of the centerstand should be checked before each ride, and the pivots and metal-to-metal contact surfaces should be lubricated if necessary.

EWA11301

WARNING

If the centerstand does not move up and down smoothly, have a Yamaha dealer check or repair it. Otherwise, the centerstand could contact the ground and distract the operator, resulting in a possible loss of control.

Recommended lubricant:
Lithium-soap-based grease

Checking the front fork

EAU23272

The condition and operation of the front fork must be checked as follows at the intervals specified in the periodic maintenance and lubrication chart.

To check the condition

Check the inner tubes for scratches, damage and excessive oil leakage.

To check the operation

1. Place the vehicle on a level surface and hold it in an upright position. **WARNING! To avoid injury, securely support the vehicle so there is no danger of it falling over.** [EWA10751]
2. While applying the front brake, push down hard on the handlebars several times to check if the front fork compresses and rebounds smoothly.

PERIODIC MAINTENANCE AND ADJUSTMENT

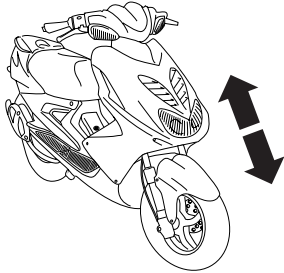

ZAJM0296

ECA10590

NOTICE

If any damage is found or the front fork does not operate smoothly, have a Yamaha dealer check or repair it.

Checking the steering

EAU45511

Worn or loose steering bearings may cause danger. Therefore, the operation of the steering must be checked as follows at the intervals specified in the periodic maintenance and lubrication chart.

1. Place the vehicle on the centerstand. **WARNING! To avoid injury, securely support the vehicle so there is no danger of it falling over.** [EWA10751]
2. Hold the lower ends of the front fork legs and try to move them forward and backward. If any free play can be felt, have a Yamaha dealer check or repair the steering.

Checking the wheel bearings

EAU23290

The front and rear wheel bearings must be checked at the intervals specified in the periodic maintenance and lubrication chart. If there is play in the wheel hub or if the wheel does not turn smoothly, have a Yamaha dealer check the wheel bearings.

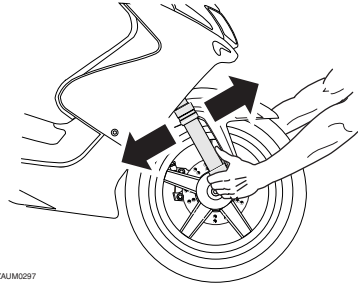

ZAJM0297

PERIODIC MAINTENANCE AND ADJUSTMENT

Battery

EAUM1403

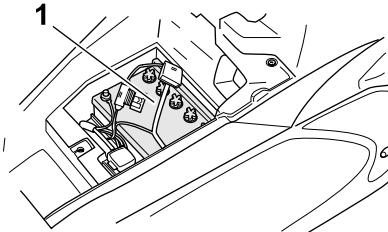

ZALUM0281

1. Battery

A poorly maintained battery will corrode and discharge quickly. The electrolyte level, battery lead connections and breather hose routing should be checked before each ride and at the intervals specified in the periodic maintenance and lubrication chart.

To check the electrolyte level

1. Place the scooter on a level surface and hold it in an upright position.

TIP _____
Make sure that the scooter is positioned straight up when checking the electrolyte level.

2. Remove panel A. (See page 6-6.)
3. Check the electrolyte level in the battery.

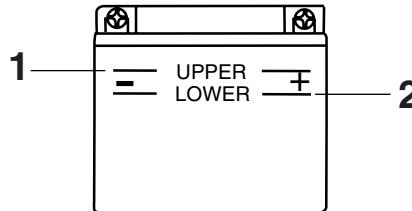

ZALUM106

1. Maximum level mark
2. Minimum level mark

TIP _____
The electrolyte should be between the minimum and maximum level marks.

4. If the electrolyte is at or below the minimum level mark, add distilled water to raise it to the maximum level mark. **NOTICE: Use only**

distilled water, as tap water contains minerals that are harmful to the battery. [ECA10611]

EWA10760

! WARNING

- **Electrolyte is poisonous and dangerous since it contains sulfuric acid, which causes severe burns. Avoid any contact with skin, eyes or clothing and always shield your eyes when working near batteries. In case of contact, administer the following FIRST AID.**
 - **EXTERNAL:** Flush with plenty of water.
 - **INTERNAL:** Drink large quantities of water or milk and immediately call a physician.
 - **EYES:** Flush with water for 15 minutes and seek prompt medical attention.
- **Batteries produce explosive hydrogen gas. Therefore, keep sparks, flames, cigarettes, etc., away from the battery and provide sufficient ventilation when charging it in an enclosed space.**

PERIODIC MAINTENANCE AND ADJUSTMENT

- **KEEP THIS AND ALL BATTERIES OUT OF THE REACH OF CHILDREN.**

5. Check and, if necessary, tighten the battery lead connections and correct the breather hose routing.

To store the battery

1. If the scooter will not be used for more than one month, remove the battery, fully charge it, and then place it in a cool, dry place. **NOTICE: When removing the battery, be sure the key is turned to “⊗”, then disconnect the negative lead before disconnecting the positive lead.** [ECA16302]
2. If the battery will be stored for more than two months, check the specific gravity of the electrolyte at least once a month and fully charge the battery whenever necessary.
3. Fully charge the battery before installation.
4. After installation, make sure that the battery leads are properly connected to the battery terminals and that the breather hose is properly

routed, in good condition, and not obstructed. **NOTICE: If the breather hose is positioned in such a way that the frame is exposed to electrolyte or gas expelled from the battery, the frame could suffer structural and external damages.** [ECA10601]

Replacing the fuse

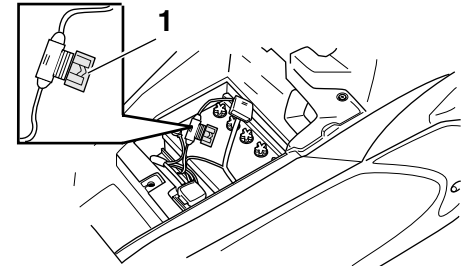

ZAJM0292

1. Fuse

The fuse holder is located behind panel A. (See page 6-6.)

If the fuse is blown, replace it as follows.

1. Turn the key to “⊗” and turn off all electrical circuits.
2. Remove the blown fuse, and then install a new fuse of the specified amperage. **WARNING! Do not use a fuse of a higher amperage rating than recommended to avoid causing extensive damage to the electrical system and possibly a fire.** [EWA15131]

PERIODIC MAINTENANCE AND ADJUSTMENT

Specified fuse:
7.5 A

3. Turn the key to “○” and turn on the electrical circuits to check if the devices operate.
4. If the fuse immediately blows again, have a Yamaha dealer check the electrical system.

Replacing the headlight bulb EAUM2111

If the headlight bulb burns out, replace it as follows.

ECA10670

NOTICE

It is advisable to have a Yamaha dealer perform this job.

1. Remove cowling A. (See page 6-6.)
2. Disconnect the headlight coupler.
3. Remove the headlight bulb holder by turning it counterclockwise, and then remove the burnt out bulb.

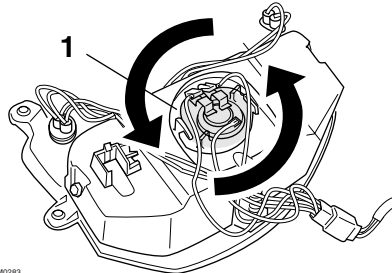

ZALM0283

1. Headlight bulb holder
4. Place a new headlight bulb into position, and then secure it with the bulb holder.
5. Connect the coupler.

6. Install the cowling.
7. Have a Yamaha dealer adjust the headlight beam if necessary.

PERIODIC MAINTENANCE AND ADJUSTMENT

Replacing the tail/brake light bulb EAU24133

1. Remove the tail/brake light lens by removing the screws.

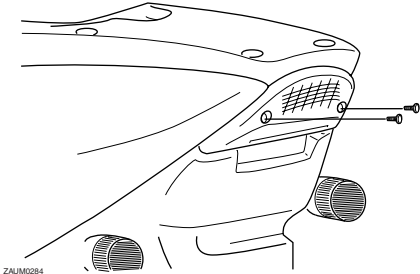

2. Remove the burnt-out bulb by pushing it in and turning it counter-clockwise.
3. Insert a new bulb into the socket, push it in, and then turn it clockwise until it stops.
4. Install the lens by installing the screws. **NOTICE: Do not over-tighten the screws, otherwise the lens may break.** [ECA10681]

Replacing a turn signal light bulb EAU24204

1. Remove the turn signal light lens by removing the screw.

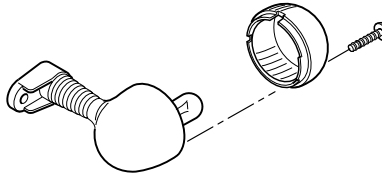
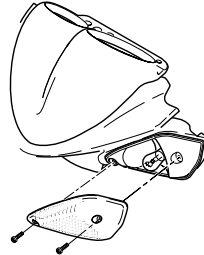

2. Remove the burnt-out bulb by pushing it in and turning it counter-clockwise.

3. Insert a new bulb into the socket, push it in, and then turn it clockwise until it stops.
4. Install the lens by installing the screw. **NOTICE: Do not over-tighten the screw, otherwise the lens may break.** [ECA11191]

PERIODIC MAINTENANCE AND ADJUSTMENT

EAU25881

Troubleshooting

Although Yamaha scooters receive a thorough inspection before shipment from the factory, trouble may occur during operation. Any problem in the fuel, compression, or ignition systems, for example, can cause poor starting and loss of power.

The following troubleshooting charts represent quick and easy procedures for checking these vital systems yourself. However, should your scooter require any repair, take it to a Yamaha dealer, whose skilled technicians have the necessary tools, experience, and know-how to service the scooter properly.

Use only genuine Yamaha replacement parts. Imitation parts may look like Yamaha parts, but they are often inferior, have a shorter service life and can lead to expensive repair bills.

EWA15141

WARNING

When checking the fuel system, do not smoke, and make sure there are no open flames or sparks in the area, including pilot lights from water

heaters or furnaces. Gasoline or gasoline vapors can ignite or explode, causing severe injury or property damage.

Troubleshooting charts

Starting problems or poor engine performance

1. Fuel



2. Compression

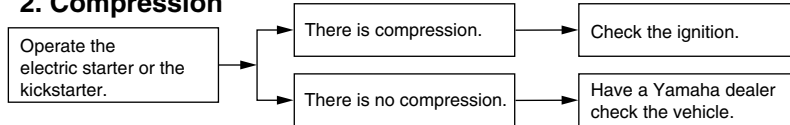

3. Ignition

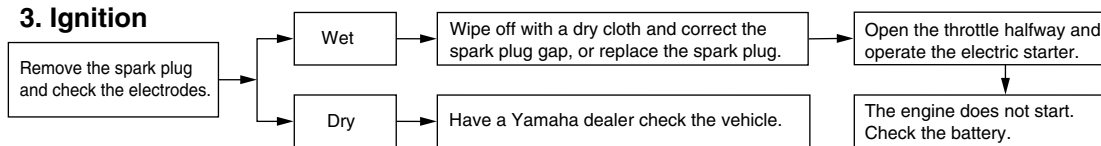

4. Battery

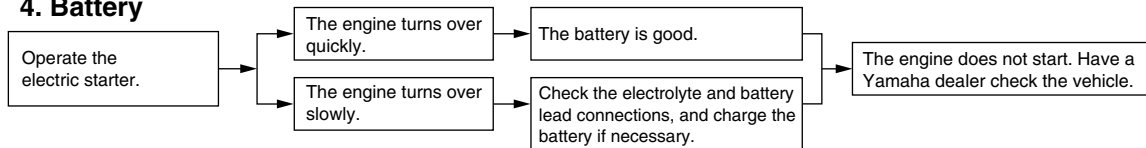

PERIODIC MAINTENANCE AND ADJUSTMENT

Engine overheating

EWA10400

WARNING

- Do not remove the radiator cap when the engine and radiator are hot. Scalding hot fluid and steam may be blown out under pressure, which could cause serious injury. Be sure to wait until the engine has cooled.
- After removing the radiator cap retaining bolt, place a thick rag, like a towel, over the radiator cap, and then slowly rotate the cap counterclockwise to the detent to allow any residual pressure to escape. When the hissing sound has stopped, press down on the cap while turning it counterclockwise, and then remove the cap.

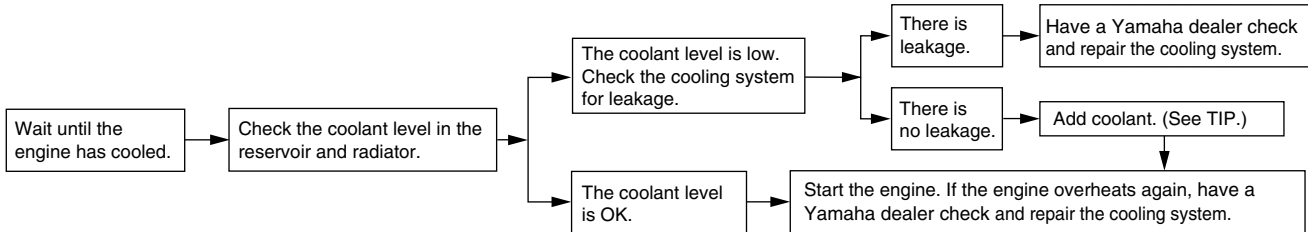

TIP

If coolant is not available, tap water can be temporarily used instead, provided that it is changed to the recommended coolant as soon as possible.

SCOOTER CARE AND STORAGE

Care

EAU26093

While the open design of a scooter reveals the attractiveness of the technology, it also makes it more vulnerable. Rust and corrosion can develop even if high-quality components are used. A rusty exhaust pipe may go unnoticed on a car, however, it detracts from the overall appearance of a scooter. Frequent and proper care does not only comply with the terms of the warranty, but it will also keep your scooter looking good, extend its life and optimize its performance.

Before cleaning

1. Cover the muffler outlet with a plastic bag after the engine has cooled down.
2. Make sure that all caps and covers as well as all electrical couplers and connectors, including the spark plug cap, are tightly installed.
3. Remove extremely stubborn dirt, like oil burnt onto the crankcase, with a degreasing agent and a brush, but never apply such prod-

ucts onto seals, gaskets and wheel axles. Always rinse the dirt and degreaser off with water.

Cleaning

ECA10782

NOTICE

- **Avoid using strong acidic wheel cleaners, especially on spoked wheels. If such products are used on hard-to-remove dirt, do not leave the cleaner on the affected area any longer than instructed. Also, thoroughly rinse the area off with water, immediately dry it, and then apply a corrosion protection spray.**
- **Improper cleaning can damage plastic parts (such as cowlings, panels, windshields, headlight lenses, meter lenses, etc.) and the mufflers. Use only a soft, clean cloth or sponge with water to clean plastic. However, if the plastic parts cannot be thoroughly cleaned with water, diluted mild detergent with water may be used. Be sure to rinse**

off any detergent residue using plenty of water, as it is harmful to plastic parts.

- **Do not use any harsh chemical products on plastic parts. Be sure to avoid using cloths or sponges which have been in contact with strong or abrasive cleaning products, solvent or thinner, fuel (gasoline), rust removers or inhibitors, brake fluid, antifreeze or electrolyte.**
- **Do not use high-pressure washers or steam-jet cleaners since they cause water seepage and deterioration in the following areas: seals (of wheel and swing-arm bearings, fork and brakes), electric components (couplers, connectors, instruments, switches and lights), breather hoses and vents.**
- **For scooters equipped with a windshield: Do not use strong cleaners or hard sponges as they will cause dulling or scratching. Some cleaning compounds for plastic may leave scratches on the windshield.**

SCOOTER CARE AND STORAGE

Test the product on a small hidden part of the windshield to make sure that it does not leave any marks. If the windshield is scratched, use a quality plastic polishing compound after washing.

After normal use

Remove dirt with warm water, a mild detergent, and a soft, clean sponge, and then rinse thoroughly with clean water. Use a toothbrush or bottlebrush for hard-to-reach areas. Stubborn dirt and insects will come off more easily if the area is covered with a wet cloth for a few minutes before cleaning.

After riding in the rain, near the sea or on salt-sprayed roads

Since sea salt or salt sprayed on the roads during winter are extremely corrosive in combination with water, carry out the following steps after each ride in the rain, near the sea or on salt-sprayed roads.

TIP

Salt sprayed on roads in the winter may remain well into spring.

1. Clean the scooter with cold water and a mild detergent after the engine has cooled down. **NOTICE: Do not use warm water since it increases the corrosive action of the salt.** [ECA10791]
2. Apply a corrosion protection spray on all metal, including chrome- and nickel-plated, surfaces to prevent corrosion.

After cleaning

1. Dry the scooter with a chamois or an absorbing cloth.
2. Use a chrome polish to shine chrome, aluminum and stainless-steel parts, including the exhaust system. (Even the thermally induced discoloring of stainless-steel exhaust systems can be removed through polishing.)

3. To prevent corrosion, it is recommended to apply a corrosion protection spray on all metal, including chrome- and nickel-plated, surfaces.
4. Use spray oil as a universal cleaner to remove any remaining dirt.
5. Touch up minor paint damage caused by stones, etc.
6. Wax all painted surfaces.
7. Let the scooter dry completely before storing or covering it.

EWA10941

WARNING

Contaminants on the brakes or tires can cause loss of control.

- **Make sure that there is no oil or wax on the brakes or tires. If necessary, clean the brake discs and brake linings with a regular brake disc cleaner or acetone, and wash the tires with warm water and a mild detergent.**
 - **Before operating the scooter test its braking performance and cornering behavior.**
-

ECA10800

NOTICE

- Apply spray oil and wax sparingly and make sure to wipe off any excess.
- Never apply oil or wax to any rubber and plastic parts, but treat them with a suitable care product.
- Avoid using abrasive polishing compounds as they will wear away the paint.

TIP

- Consult a Yamaha dealer for advice on what products to use.
- Washing, rainy weather or humid climates can cause the headlight lens to fog. Turning the headlight on for a short period of time will help remove the moisture from the lens.

EAU26301

Storage

Short-term

Always store your scooter in a cool, dry place and, if necessary, protect it against dust with a porous cover.

ECA10820

NOTICE

- Storing the scooter in a poorly ventilated room or covering it with a tarp, while it is still wet, will allow water and humidity to seep in and cause rust.
- To prevent corrosion, avoid damp cellars, stables (because of the presence of ammonia) and areas where strong chemicals are stored.

Long-term

Before storing your scooter for several months:

1. Follow all the instructions in the “Care” section of this chapter.

2. Drain the carburetor float chamber by loosening the drain bolt; this will prevent fuel deposits from building up. Pour the drained fuel into the fuel tank.
3. Fill up the fuel tank and add fuel stabilizer (if available) to prevent the fuel tank from rusting and the fuel from deteriorating.
4. Perform the following steps to protect the cylinder, piston rings, etc. from corrosion.
 - a. Remove the spark plug cap and spark plug.
 - b. Pour a teaspoonful of engine oil into the spark plug bore.
 - c. Install the spark plug cap onto the spark plug, and then place the spark plug on the cylinder head so that the electrodes are grounded. (This will limit sparking during the next step.)
 - d. Turn the engine over several times with the starter. (This will coat the cylinder wall with oil.)
WARNING! To prevent damage or injury from sparking, make sure to ground the

SCOOTER CARE AND STORAGE

spark plug electrodes while turning the engine over.

[EWA10951]

- e. Remove the spark plug cap from the spark plug, and then install the spark plug and the spark plug cap.
5. Lubricate all control cables and the pivoting points of all levers and pedals as well as of the side-stand/centerstand.
6. Check and, if necessary, correct the tire air pressure, and then lift the scooter so that both of its wheels are off the ground. Alternatively, turn the wheels a little every month in order to prevent the tires from becoming degraded in one spot.
7. Cover the muffler outlet with a plastic bag to prevent moisture from entering it.
8. Remove the battery and fully charge it. Store it in a cool, dry place and charge it once a month. Do not store the battery in an excessively cold or warm place [less than 0 °C (30 °F) or more than 30

°C (90 °F)]. For more information on storing the battery, see page 6-19.

TIP

Make any necessary repairs before storing the scooter.

Dimensions:

- Overall length:
1818 mm (71.6 in)
- Overall width:
719 mm (28.3 in)
- Overall height:
1170 mm (46.1 in)
- Seat height:
828 mm (32.6 in)
- Wheelbase:
1256 mm (49.4 in)
- Ground clearance:
148 mm (5.83 in)
- Minimum turning radius:
1800 mm (70.9 in)

Weight:

- With oil and fuel:
97.0 kg (214 lb)

Engine:

- Engine type:
Liquid cooled 2-stroke
- Cylinder arrangement:
Forward-inclined single cylinder
- Displacement:
49.0 cm³
- Bore × stroke:
40.0 × 39.2 mm (1.57 × 1.54 in)
- Compression ratio:
7.90 :1
- Starting system:
Electric starter and kickstarter
- Lubrication system:
Separate lubrication (Yamaha autolube)

Engine oil:

- Type:
YAMALUBE 2 or 2-stroke engine oil (JASO FC grade) or (ISO EG-C or EG-D grade)
- Engine oil quantity:
Quantity:
1.40 L (1.48 US qt, 1.23 Imp.qt)

Final transmission oil:

- Type:
SAE 10W-30 type SE motor oil
- Quantity:
0.11 L (0.12 US qt, 0.10 Imp.qt)

Cooling system:

- Coolant reservoir capacity (up to the maximum level mark):
0.25 L (0.26 US qt, 0.22 Imp.qt)
- Radiator capacity (including all routes):
1.20 L (1.27 US qt, 1.06 Imp.qt)

Air filter:

- Air filter element:
Wet element

Fuel:

- Recommended fuel:
Premium unleaded gasoline only
- Fuel tank capacity:
7.0 L (1.85 US gal, 1.54 Imp.gal)

Carburetor:

- Manufacturer:
GURTNER
- Type × quantity:
PY 12 x 1

Spark plug (s):

- Manufacturer/model:
NGK/BR8HS

- Spark plug gap:
0.6–0.7 mm (0.024–0.028 in)

Clutch:

- Clutch type:
Dry, centrifugal automatic

Transmission:

- Primary reduction system:
Helical gear
- Primary reduction ratio:
52 × 13 (4.000)
- Secondary reduction system:
Spur gear
- Secondary reduction ratio:
43 × 14 (3.070)
- Transmission type:
V-belt automatic
- Operation:
Centrifugal automatic type

Chassis:

- Frame type:
Steel tube underbone
- Caster angle:
27.00 °
- Trail:
90.0 mm (3.54 in)

Front tire:

- Type:
Tubeless
- Size:
130/60-13 53L (MICHELIN), 53P (PIRELLI)
- Manufacturer/model:
MICHELIN / PILOT SPORT
- Manufacturer/model:
PIRELLI / EVO21

SPECIFICATIONS

Rear tire:

Type:

Tubeless

Size:

140/60-13 57L (MICHELIN), 53P (PIRELLI)

Manufacturer/model:

MICHELIN / PILOT SPORT

Manufacturer/model:

PIRELLI / EVO22

Loading:

Maximum load:

180 kg (397 lb)

(Total weight of rider, passenger, cargo and accessories)

Tire air pressure (measured on cold tires):

Loading condition:

0–90 kg (0–198 lb)

Front:

150 kPa (1.50 kgf/cm², 22 psi)

Rear:

150 kPa (1.50 kgf/cm², 22 psi)

Loading condition:

90–180 kg (198–397 lb)

Front:

160 kPa (1.60 kgf/cm², 23 psi)

Rear:

170 kPa (1.70 kgf/cm², 25 psi)

Front wheel:

Wheel type:

Cast wheel

Rim size:

13xMT3.00

Rear wheel:

Wheel type:

Cast wheel

Rim size:

13xMT3.50

Front brake:

Type:

Single disc brake

Operation:

Right hand operation

Recommended fluid:

DOT 3 or 4

Rear brake:

Type:

Single disc brake

Operation:

Left hand operation

Recommended fluid:

DOT 3 or 4

Front suspension:

Type:

Telescopic fork

Spring/shock absorber type:

Coil spring/oil damper

Wheel travel:

80.0 mm (3.15 in)

Rear suspension:

Type:

Unit swing

Spring/shock absorber type:

Coil spring/gas-oil damper

Wheel travel:

70.0 mm (2.76 in)

Electrical system:

Ignition system:

DC. CDI

Charging system:

AC magneto

Battery:

Model:

CB4-LB(GS), YB4L-B(YUASA)

Voltage, capacity:

12 V, 4.0 Ah

Headlight:

Bulb type:

Incandescence

Bulb voltage, wattage × quantity:

Headlight:

12 V, 35 W/35.0 W × 1

Tail/brake light:

12 V, 21.0 W/5.0 W × 1

Front turn signal light:

12 V, 10.0 W × 2

Rear turn signal light:

12 V, 10.0 W × 2

Meter lighting:

12 V, 1.7 W × 2

High beam indicator light:

12 V, 1.7 W × 1

Oil level warning light:

12 V, 1.7 W × 1

Turn signal indicator light:

12 V, 1.7 W × 1

Coolant temperature warning light:

12 V, 1.7 W × 1

Fuses:

Main fuse:

7.5 A

CONSUMER INFORMATION

Identification numbers

Record the key identification number, vehicle identification number and model label information in the spaces provided below for assistance when ordering spare parts from a Yamaha dealer or for reference in case the vehicle is stolen.

KEY IDENTIFICATION NUMBER:

VEHICLE IDENTIFICATION NUMBER:

MODEL LABEL INFORMATION:

EAU26351

Key identification number

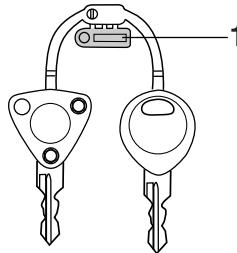

ZAJM0070

1. Key identification number

The key identification number is stamped into the key tag. Record this number in the space provided and use it for reference when ordering a new key.

EAU26381

Vehicle identification number

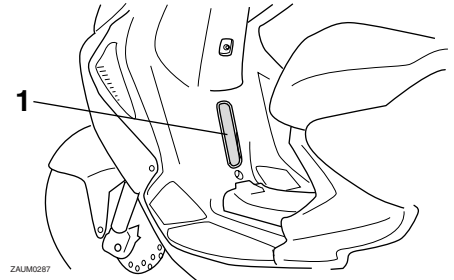

ZAJM0287

1. Vehicle identification number

The vehicle identification number is stamped into the frame.

TIP _____
The vehicle identification number is used to identify your vehicle and may be used to register it with the licensing authority in your area.

EAU26410

EAUM2540

Model label

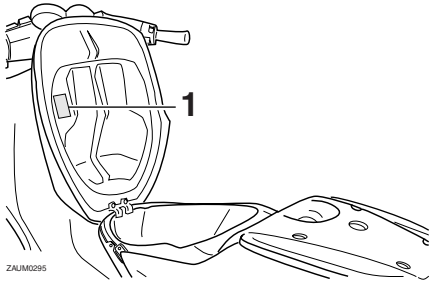

ZAJM0295

1. Model label

The model label is affixed to the bottom of the rider seat. (See page 3-9.) Record the information on this label in the space provided. This information will be needed when ordering spare parts from a Yamaha dealer.

INDEX

- A**
Acceleration and deceleration..... 5-2
Air filter element, cleaning..... 6-10
- B**
Battery..... 6-19
Brake fluid, changing 6-16
Brake fluid level, checking 6-15
Brake lever, front..... 3-5
Brake lever, rear 3-5
Brake levers, lubricating..... 6-16
Braking..... 5-2
- C**
Carburetor, adjusting 6-11
Care 7-1
Catalytic converters 3-7
Centerstand, checking and
lubricating 6-17
Coolant..... 6-9
Coolant temperature warning light..... 3-2
Cowling and panel, removing and
installing..... 6-6
- D**
Dimmer switch 3-4
- E**
Engine break-in..... 5-3
Engine oil 3-8
- F**
Final transmission oil 6-8
Front and rear brake lever free play,
checking 6-14
Front and rear brake pads, checking 6-14
Front fork, checking 6-17
Fuel 3-6
Fuel consumption, tips for reducing 5-3
Fuel gauge..... 3-4
Fuel tank cap 3-5
Fuse, replacing 6-20
- H**
Handlebar switches 3-4
Headlight bulb, replacing 6-21
High beam indicator light 3-2
Horn switch..... 3-4
- I**
Identification numbers 9-1
Indicator and warning lights..... 3-2
- K**
Key identification number 9-1
Kickstarter..... 3-9
- M**
Main switch/steering lock..... 3-1
Model label 9-2
- O**
Oil level warning light..... 3-2
- P**
Parking 5-4
Part locations..... 2-1
Periodic maintenance and lubrication
chart 6-2
- R**
Rider seat 3-9
- S**
Safe-riding points..... 1-5
Safety information..... 1-1
Shock absorber assembly, adjusting
(if equipped) 3-11
Spark plug, checking 6-7
Specifications 8-1
Speedometer unit 3-3
Starting a cold engine 5-1
Starting off..... 5-2
Start switch..... 3-4
Steering, checking..... 6-18
Storage..... 7-3
Storage compartments..... 3-10
- T**
Tachometer (if equipped) 3-3
Tail/brake light bulb, replacing 6-22
Throttle cable free play, checking 6-11
Throttle grip and cable, checking and
lubricating 6-16
Tires 6-12
Troubleshooting 6-23
Troubleshooting charts..... 6-24
Turn signal indicator light 3-2
Turn signal light bulb, replacing 6-22
Turn signal switch 3-4
- V**
Vehicle identification number 9-1
- W**
Wheel bearings, checking 6-18
Wheels 6-13



PRINTED IN FRANCE
2008.08 (E)