



OWNER'S MANUAL



DT125R

3MB-28199-E7

Welcome to the Yamaha world of motorcycling!

As the owner of a DT125R, you are benefiting from Yamaha's vast experience in and newest technology for the design and the manufacture of high-quality products, which have earned Yamaha a reputation for dependability.

Please take the time to read this manual thoroughly, so as to enjoy all your DT125R's advantages. The owner's manual does not only instruct you in how to operate, inspect and maintain your motorcycle, but also in how to safeguard yourself and others from trouble and injury.

In addition, the many tips given in this manual will help to keep your motorcycle in the best possible condition. If you have any further questions, do not hesitate to contact your Yamaha dealer.

The Yamaha team wishes you many safe and pleasant rides. So, remember to put safety first!

IMPORTANT MANUAL INFORMATION

EAU00005

Particularly important information is distinguished in this manual by the following notations:



The Safety Alert Symbol means **ATTENTION! BECOME ALERT! YOUR SAFETY IS INVOLVED!**



Failure to follow **WARNING** instructions could result in severe injury or death to the motorcycle operator, a bystander or a person inspecting or repairing the motorcycle.

CAUTION:

A **CAUTION** indicates special precautions that must be taken to avoid damage to the motorcycle.

NOTE:

A **NOTE** provides key information to make procedures easier or clearer.

NOTE: _____

- This manual should be considered a permanent part of this motorcycle and should remain with it even if the motorcycle is subsequently sold.
 - Yamaha continually seeks advancements in product design and quality. Therefore, while this manual contains the most current product information available at the time of printing, there may be minor discrepancies between your motorcycle and this manual. If there is any question concerning this manual, please consult your Yamaha dealer.
-

IMPORTANT MANUAL INFORMATION

EW000002

⚠️ WARNING

PLEASE READ THIS MANUAL CAREFULLY AND COMPLETELY BEFORE OPERATING THIS MOTORCYCLE.

EAU03337

DT125R

OWNER'S MANUAL

© 2000 by Yamaha Motor Co., Ltd.

1st Edition, December 2000

All rights reserved.

**Any reprinting or unauthorized use
without the written permission of
Yamaha Motor Co., Ltd.**

is expressly prohibited.

Printed in Japan.

TABLE OF CONTENTS

1	GIVE SAFETY THE RIGHT OF WAY.....	1-1	Kick starter.....	3-11	
2	DESCRIPTION	2-1	Steering lock.....	3-11	
	Left view.....	2-1	Seat	3-12	
	Right view	2-2	Helmet holder	3-12	
	Controls/Instruments.....	2-3	Rear shock absorber adjustment.....	3-13	
3	INSTRUMENT AND CONTROL FUNCTIONS	3-1	Rear carrier.....	3-14	
	Main switch	3-1	Note on handling of the Yamaha Energy		
	Indicator lights.....	3-1	Induction System (Y.E.I.S.).....	3-14	
	Oil level indicator circuit check.....	3-2	Y.P.V.S.		
	Speedometer	3-3	(Yamaha Power Valve System)	3-15	
	Tachometer.....	3-3	Sidestand.....	3-15	
	Engine temperature gauge	3-4	Sidestand switch operation check	3-16	
	Handlebar switches	3-4	4	PRE-OPERATION CHECKS	4-1
	Clutch lever.....	3-5		Pre-operation check list	4-1
	Shift pedal.....	3-5	5	OPERATION AND IMPORTANT RIDING	
	Front brake lever.....	3-6		POINTS.....	5-1
	Rear brake pedal	3-6		Starting the engine.....	5-1
	Fuel tank cap	3-6		Starting a warm engine	5-3
	Fuel (except for Switzerland and Austria).....	3-7		Shifting	5-4
	Fuel (for Switzerland and Austria)	3-7		Recommended shift points	
	Catalyzer (for Switzerland and Austria)	3-8		(for Switzerland only)	5-4
	Two-stroke engine oil.....	3-9		Tips for reducing fuel consumption	5-5
	Fuel cock	3-9		Engine break-in.....	5-5
	Starter (choke) “ ”.....	3-10		Parking.....	5-6

TABLE OF CONTENTS

6	PERIODIC MAINTENANCE AND MINOR REPAIR.....6-1	Inspecting the brake fluid level6-24
	Tool kit6-1	Brake fluid replacement6-25
	Periodic maintenance and lubrication chart6-3	Drive chain slack check6-25
	Cowling removal and installation6-6	Drive chain slack adjustment6-26
	Cowling A.....6-6	Drive chain lubrication6-26
	Cowling B.....6-7	Cable inspection and lubrication6-27
	Cowling C6-8	Throttle cable and grip lubrication.....6-27
	Panel removal and installation6-8	Autolube pump adjustment6-28
	Panel D6-9	Brake and shift pedal lubrication.....6-28
	Panel E6-9	Brake and clutch lever lubrication6-28
	Spark plug.....6-10	Sidestand lubrication6-29
	Transmission oil6-11	Front fork inspection6-29
	Cooling system6-12	Steering inspection6-30
	Changing the coolant.....6-13	Wheel bearings.....6-30
	Air filter.....6-15	Battery6-31
	Carburetor adjustment6-16	Fuse replacement6-33
	Idle speed adjustment.....6-17	Headlight bulb replacement6-33
	Throttle cable free play adjustment.....6-17	Turn signal light bulb replacement.....6-35
	Tires6-18	Tail/brake light bulb replacement.....6-35
	Wheels.....6-20	Supporting the motorcycle6-36
	Clutch lever free play adjustment6-21	Front wheel removal6-36
	Front brake lever free play adjustment6-21	Front wheel installation6-37
	Rear brake pedal height adjustment.....6-22	Rear wheel removal.....6-38
	Brake light switch adjustment6-23	Rear wheel installation.....6-39
	Checking the front and rear brake pads6-23	Troubleshooting6-39
		Troubleshooting chart6-40

TABLE OF CONTENTS

- 7** MOTORCYCLE CARE AND STORAGE7-1
 - Care7-1
 - Storage7-4

- 8** SPECIFICATIONS8-1
 - How to use the conversion table.....8-5

- 9** CONSUMER INFORMATION9-1
 - Identification number records9-1
 - Key identification number9-1
 - Vehicle identification number9-1
 - Model label9-2



GIVE SAFETY THE RIGHT OF WAY

Motorcycles are fascinating vehicles, which can give you an unsurpassed feeling of power and freedom. However, they also impose certain limits, which you must accept; even the best motorcycle does not ignore the laws of physics.

Regular care and maintenance are essential for preserving your motorcycle's value and operating condition. Moreover, what is true for the motorcycle is also true for the rider: good performance depends on being in good shape. Riding under the influence of medication, drugs and alcohol is, of course, out of the question. Motorcycle riders - more than car drivers - must always be at their mental and physical best. Under the influence of even small amounts of alcohol, there is a tendency to take dangerous risks.

Protective clothing is as essential for the motorcycle rider as seat belts are for car drivers and passengers. Always wear a complete motorcycle suit (whether made of leather or tear-resistant synthetic materials with protectors), sturdy boots, motorcycle gloves and a properly fitting helmet. Optimum protective wear, however, should not encourage carelessness. Though full-coverage helmets and suits, in particular, create an illusion of total safety and protection, motorcyclists will always be vulnerable. Riders who lack critical self-control run the risk of going too fast and are apt to take chances. This is even more dangerous in wet weather. The good motorcyclist rides safely, predictably and defensively - avoiding all dangers, including those caused by others.

Enjoy your ride!

DESCRIPTION

Left view

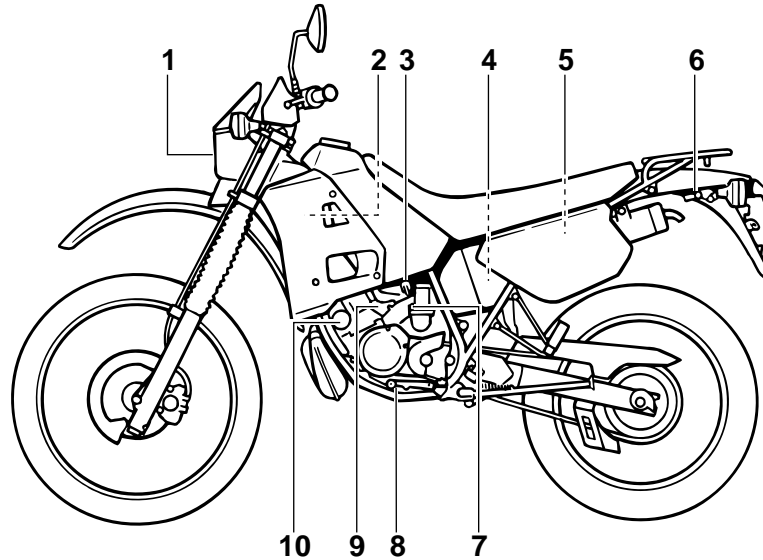

- | | | | |
|---------------------------|-------------|--------------------|-----------------|
| 1. Headlight | (page 6-33) | 7. Starter (choke) | (page 3-10) |
| 2. Radiator cap | (page 6-13) | 8. Shift pedal | (page 3-5, 5-4) |
| 3. Fuel cock | (page 3-9) | 9. Y.E.I.S. | (page 3-14) |
| 4. Air filter | (page 6-15) | 10. Y.P.V.S. | (page 3-15) |
| 5. Coolant reservoir tank | (page 6-13) | | |
| 6. Helmet holder | (page 3-12) | | |

Right view

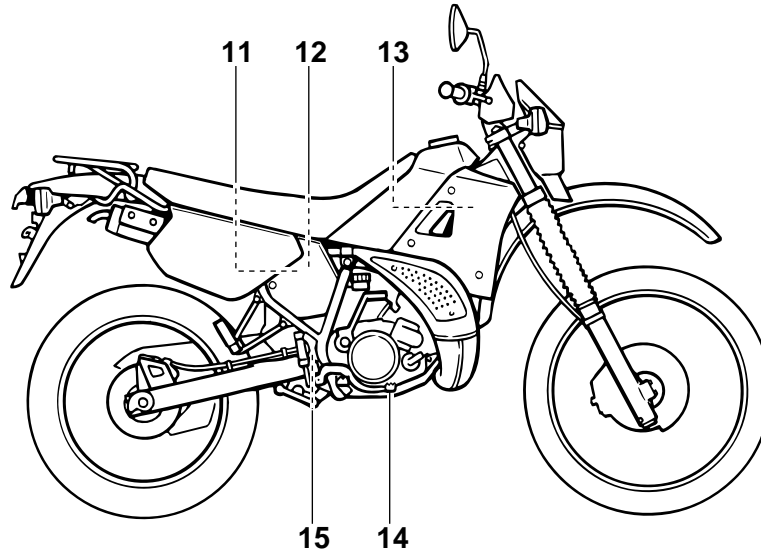

- | | |
|---------------------------------------------------------|------------------|
| 11. Tool kit | (page 6-1) |
| 12. Fuse | (page 6-33) |
| 13. Engine oil tank | (page 3-9) |
| 14. Rear brake pedal | (page 3-6, 6-22) |
| 15. Rear shock absorber spring
preload adjusting nut | (page 3-13) |

DESCRIPTION

Controls/Instruments

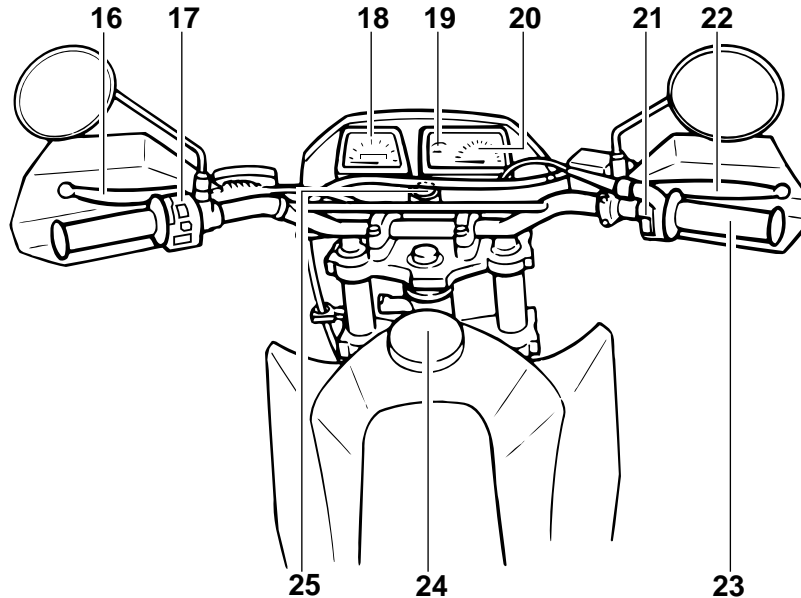

- | | | | |
|-------------------------------|------------------|------------------------------|-------------------|
| 16. Clutch lever | (page 3-5, 6-21) | 21. Right handlebar switches | (page 3-5) |
| 17. Left handlebar switches | (page 3-4) | 22. Front brake lever | (page 3-6, 6-27) |
| 18. Speedometer | (page 3-3) | 23. Throttle grip | (page 6-17, 6-27) |
| 19. Coolant temperature gauge | (page 3-4) | 24. Fuel tank cap | (page 3-6) |
| 20. Tachometer | (page 3-3) | 25. Main switch | (page 3-1) |

INSTRUMENT AND CONTROL FUNCTIONS

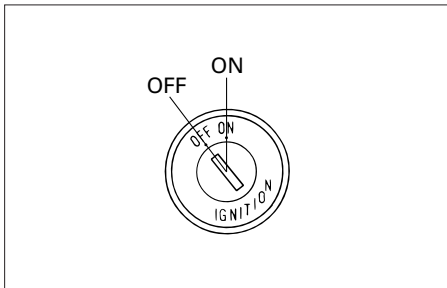

EAU00028

Main switch

The main switch controls the ignition and lighting systems. Its operation is described below.

EAU00036

ON

Electrical circuits are switched on. The engine can be started. The key cannot be removed in this position.

EAU00061

OFF

All electrical circuits are switched off. The key can be removed in this position.

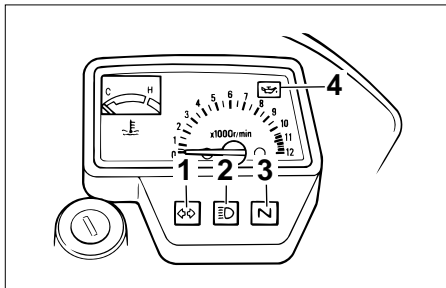

1. Turn indicator light “↔”
2. High beam indicator light “≡”
3. Neutral indicator light “N”
4. Oil level indicator light “⛢”

EAU00056

Indicator lights

EAU00057

Turn indicator light “↔”

This indicator flashes when the turn switch is moved to the left or right.

EAU00061

Neutral indicator light “N”

This indicator comes on when the transmission is in neutral.

EAU00063

High beam indicator light “≡”

This indicator comes on when the headlight high beam is used.

EAU01313

Oil level indicator light “⛢”

This indicator comes on when the oil level is low. This light circuit can be checked by the procedure on page 3-2.

EC000000

CAUTION:

Do not run the motorcycle until you know it has sufficient engine oil.

NOTE

Even if the oil is filled to the specified level, the indicator light may flicker when riding on a slope or during sudden acceleration or deceleration, but this is normal.

INSTRUMENT AND CONTROL FUNCTIONS

EAU00075

Oil level indicator circuit check

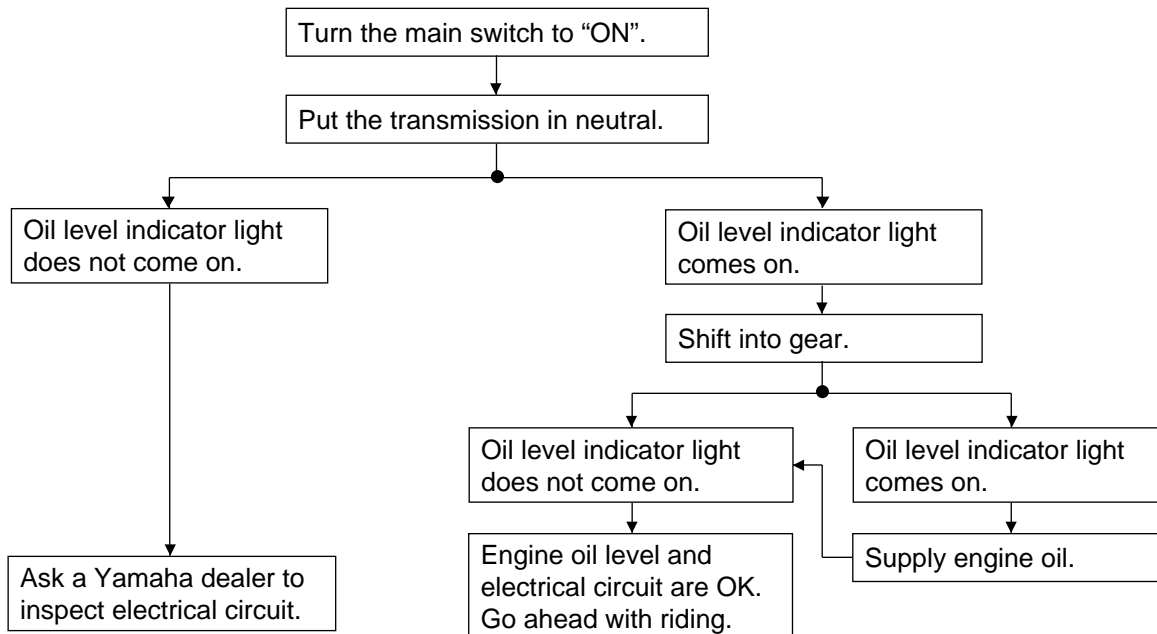

INSTRUMENT AND CONTROL FUNCTIONS

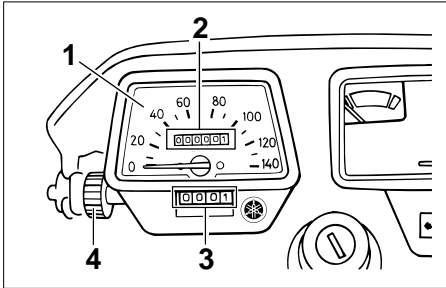

1. Speedometer
2. Odometer
3. Trip odometer
4. Reset knob

EAU01087

Speedometer

The speedometer shows riding speed. This speedometer is equipped with an odometer and trip odometer. The trip odometer can be reset to "0" with the reset knob. Use the trip odometer to estimate how far you can ride on a tank of fuel. This information will enable you to plan fuel stops in the future.

NOTE: _____
(for German model equipped with speed limiter only)
This motorcycle is equipped with a speed limiter which prevents it from exceeding a top speed of 80 km/h.

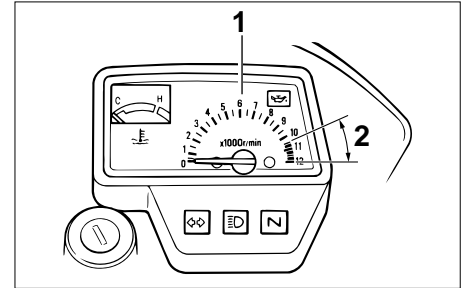

1. Tachometer
2. Red zone

EAU00102

Tachometer

This model is equipped with a tachometer so the rider can monitor the engine speed and keep it within the ideal power range.

EC000003

CAUTION: _____

Do not operate in the red zone.
Red zone: 10,500 r/min and above

INSTRUMENT AND CONTROL FUNCTIONS

EAU00127

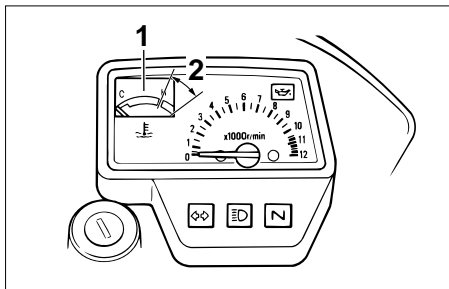

1. Coolant temperature gauge
2. Red zone

EAU01652

Coolant temperature gauge

This gauge indicates the coolant temperature when the main switch is on. The engine operating temperature will vary with changes in weather and engine load. If the needle points to the red zone or higher, stop your motorcycle and let the engine cool. (See page 6-13 for details.)

EC000002

CAUTION:

When the engine is overheated, do not continue riding.

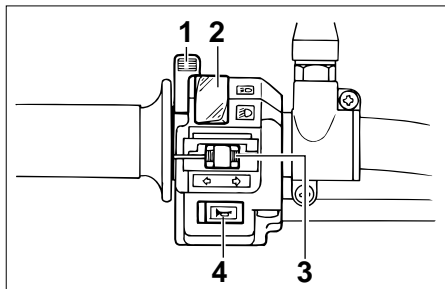

1. Lights switch
2. Dimmer switch
3. Turn signal switch
4. Horn switch

EAU00118

Handlebar switches

EAU00134

Lights switch

Turning the light switch to “”, turns on the auxiliary light, meter lights and taillight. Turning the light switch to “”, turns the headlight on also.

EAU00121

Dimmer switch

Turn the switch to “” for the high beam and to “” for the low beam.

Turn signal switch

To signal a right-hand turn, push the switch to “”. To signal a left-hand turn, push the switch to “”. Once the switch is released it will return to the center position. To cancel the signal, push the switch in after it has returned to the center position.

EAU00129

Horn switch “”

Press the switch to sound the horn.

INSTRUMENT AND CONTROL FUNCTIONS

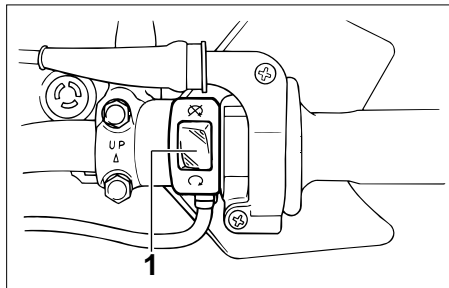

1. Engine stop switch

EAU00138

Engine stop switch

The engine stop switch is a safety device for use in an emergency such as when the motorcycle overturns or if trouble occurs in the throttle system. Turn the switch to "O" to start the engine. In case of emergency, turn the switch to "X" to stop the engine.

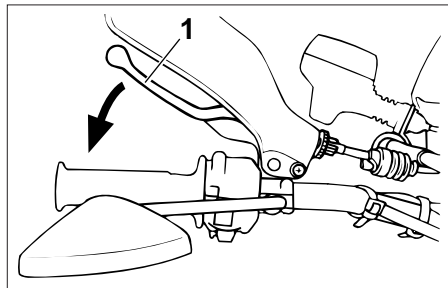

1. Clutch lever

EAU00155

Clutch lever

The clutch lever is located on the left handlebar. Pull the clutch lever to the handlebar to disengage the clutch, and release the lever to engage the clutch. The lever should be pulled rapidly and released slowly for smooth clutch operation.

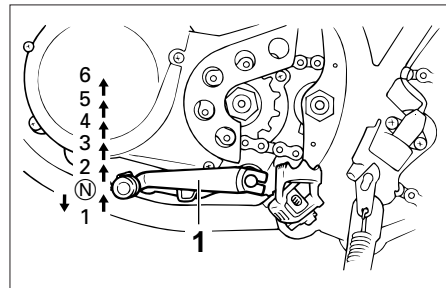

1. Shift pedal
N. Neutral

EAU00157

Shift pedal

This motorcycle is equipped with a constant-mesh 6-speed transmission. The shift pedal is located on the left side of the engine and is used in combination with the clutch when shifting.

INSTRUMENT AND CONTROL FUNCTIONS

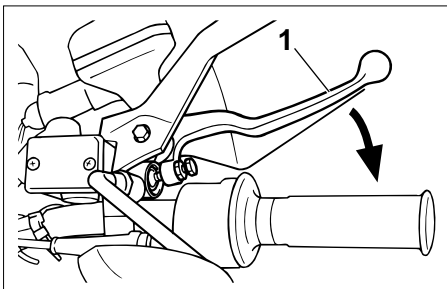

1. Front brake lever

EAU00158

Front brake lever

The front brake lever is located on the right handlebar. Pull it toward the handlebar to apply the front brake.

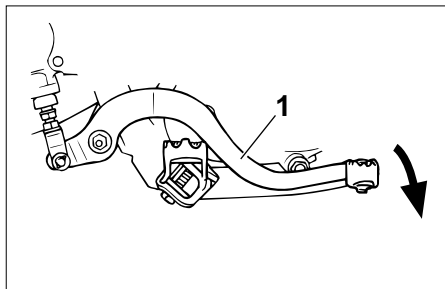

1. Rear brake pedal

EAU00162

Rear brake pedal

The rear brake pedal is on the right side of the motorcycle. Press down on the brake pedal to apply the rear brake.

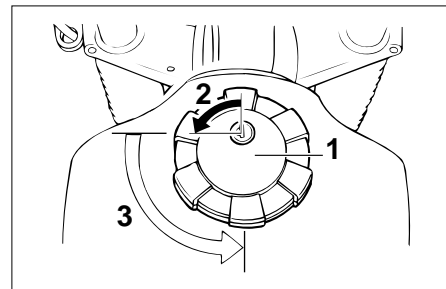

1. Fuel tank cap
2. Unlock
3. Open

EAU00177

Fuel tank cap

To open

Insert the key and turn it 1/4 turn counterclockwise. Turn the cap 1/3 turn counterclockwise and remove it from the tank.

To close

Put the cap in the filler neck and turn it 1/3 turn clockwise. Lock the cap by turning the key 1/4 turn clockwise, and remove the key.

INSTRUMENT AND CONTROL FUNCTIONS

NOTE:

The tank cap cannot be reinstalled unless it is unlocked. The key must remain in the cap until the cap is properly installed and locked onto the fuel tank.

EW000023

⚠ WARNING

Be sure the cap is properly installed and locked in place before riding the motorcycle.

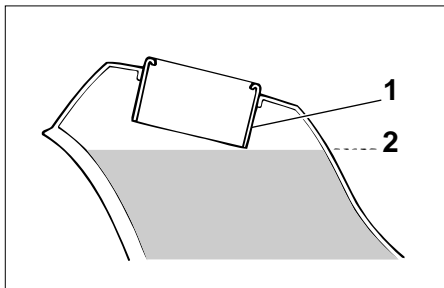

1. Filler tube
2. Fuel level

EAU01183

Fuel

(except for Switzerland and Austria)

Make sure there is sufficient fuel in the tank. Fill the fuel tank to the bottom of the filler tube as shown in the illustration.

EW000130

⚠ WARNING

Do not overfill the fuel tank. Avoid spilling fuel on the hot engine. Do not fill the fuel tank above the bottom of the filler tube or it may overflow when the fuel heats up later and expands.

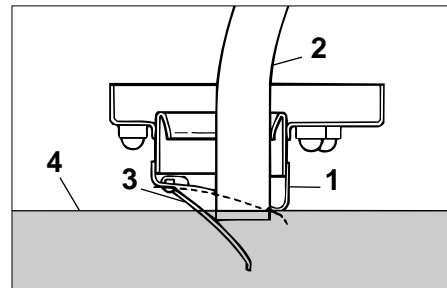

1. Filler tube
2. Filling nozzle
3. Leaf valve
4. Fuel level

EAU01184

Fuel

(for Switzerland and Austria)

Make sure there is sufficient fuel in the tank. When refueling, be sure to insert the filling nozzle into the filler hole and fill the tank to the bottom of the filler tube as shown in the illustration.

INSTRUMENT AND CONTROL FUNCTIONS

3

⚠ WARNING

EW000130

Do not overfill the fuel tank. Avoid spilling fuel on the hot engine. Do not fill the fuel tank above the bottom of the filler tube or it may overflow when the fuel heats up later and expands.

CAUTION:

EAU00185

Always wipe off spilled fuel immediately with a dry and clean soft cloth. Fuel may deteriorate painted surfaces or plastic parts.

EAU00191

Recommended fuel:

Regular unleaded gasoline with a research octane number of 91 or higher.

Fuel tank capacity:

Total:

10.0 L

Reserve:

1.8 L

NOTE:

If knocking or pinging occurs, use a different brand of gasoline or higher octane grade.

EAU01084

Catalyzer

(for Switzerland and Austria)

This motorcycle is equipped with a catalytic converter in the exhaust chamber.

⚠ WARNING

EW000128

The exhaust system is hot during and directly after engine operation. Make sure the exhaust system has cooled down before making any adjustment to or lubricating the motorcycle.

INSTRUMENT AND CONTROL FUNCTIONS

CAUTION:

EC000114

The following must be observed to prevent a fire hazard or other damages.

- Use only unleaded gasoline. Use of leaded gasoline will cause unreparable damage to the catalytic converter.
- Never park this motorcycle in an area that would cause a fire hazard such as grass or other materials that may easily burn.
- Do not allow the engine to idle for very long.

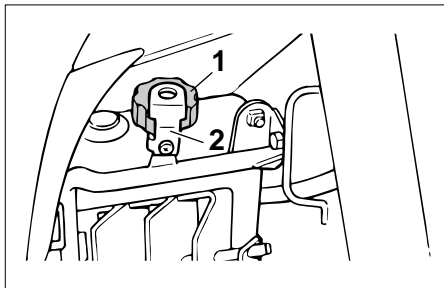

1. Oil tank cap
2. Stopper

EAU02956

Two-stroke engine oil

Make sure there is sufficient two-stroke engine oil in the oil tank. Add the recommended oil as necessary.

Recommended oil:

Yamalube 2 or 2-stroke engine oil (JASO FC grade or ISO EG-C, EG-D grade)

Oil quantity:

1.2 L

OFF: closed position

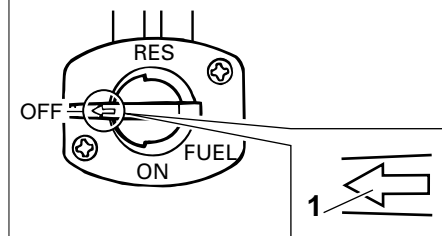

1. Arrow mark positioned "OFF"

EAU03050

Fuel cock

The fuel cock supplies fuel from the tank to the carburetor while filtering it also.

The fuel cock has three positions:

OFF

With the lever in this position, fuel will not flow. Always return the lever to this position when the engine is not running.

INSTRUMENT AND CONTROL FUNCTIONS

ON: normal position

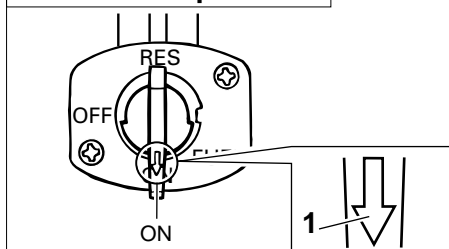

1. Arrow mark positioned "ON"

ON

With the lever in this position, fuel flows to the carburetor. Normal riding is done with the lever in this position.

RES: reserve position

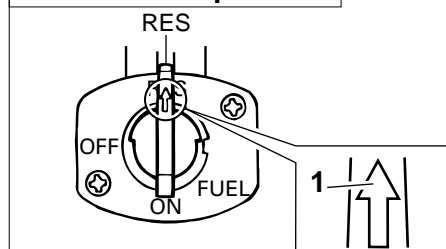

1. Arrow mark positioned "RES"

RES

This indicates reserve. If you run out of fuel while riding, move the lever to this position. Fill the tank at the first opportunity. Be sure to set the lever back to "ON" after refueling!

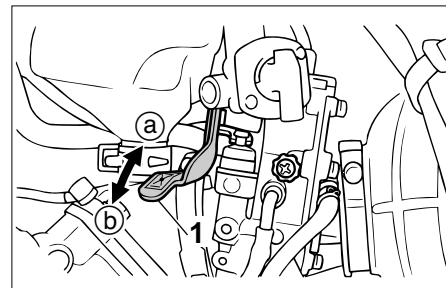

1. Starter (choke) "a"

Starter (choke) "a"

Starting a cold engine requires a richer air-fuel mixture. A separate starter circuit supplies this mixture.

Move in direction (a) to turn on the starter (choke).

Move in direction (b) to turn off the starter (choke).

EAU02976

INSTRUMENT AND CONTROL FUNCTIONS

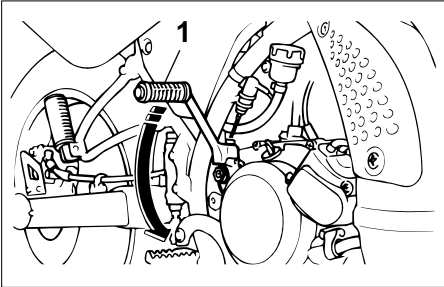

1. Kick starter

EAU00212

Kick starter

Rotate the kick starter away from the engine. Push the starter down lightly with your foot until the gears engage, then kick smoothly and forcefully to start the engine. This model has a primary-coupled kick starter so the engine can be started in any gear if the clutch is disengaged. However, shifting to neutral before starting is recommended.

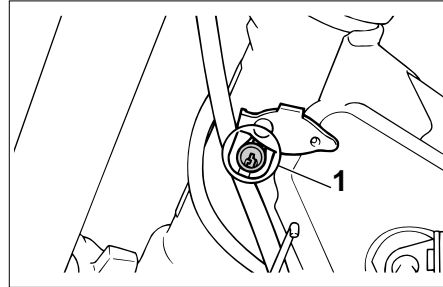

1. Steering lock

EAU02934

Steering lock

To lock the steering

Turn the handlebars all the way to the right and open the steering lock cover.

Insert the key and turn it 1/8 turn counterclockwise. Then, push the key in while turning the handlebars slightly to the left and turn the key 1/8 turn clockwise.

Check that the steering is locked, remove the key and close the lock cover.

To unlock the steering

Insert the key, push it in and turn it 1/8 turn counterclockwise so that it moves out. Then, release and remove the key.

INSTRUMENT AND CONTROL FUNCTIONS

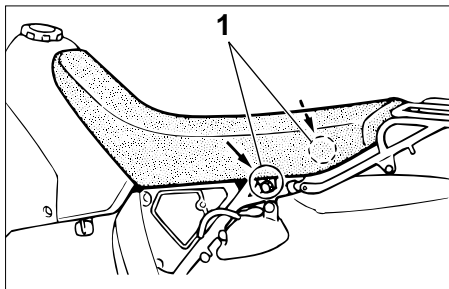

1. Bolt (x2)

EAU01648

Seat

To remove

1. Remove panels D and E. (See page 6-9 for panel removal and installation procedures.)
2. Remove the seat bolts and lift the seat upward.

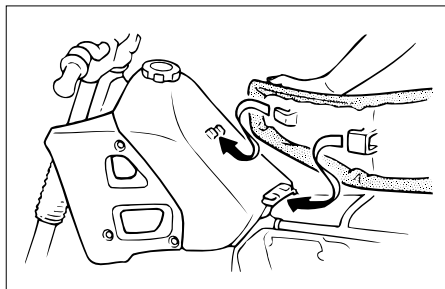

To install

1. Insert the projections on the front of the seat into the holders, then tighten the seat bolts.
2. Install the panels.

NOTE: _____
Make sure that the seat is securely fitted.

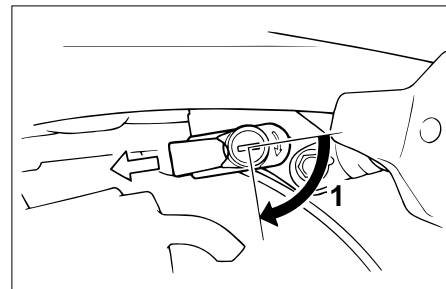

1. Open

EAU00261

Helmet holder

To open the helmet holder, insert the key in the lock and turn it as shown. To lock the helmet holder, turn the key to its original position.

EW000030

WARNING

Never ride with a helmet in the helmet holder. The helmet may hit objects, causing loss of control and possibly an accident.

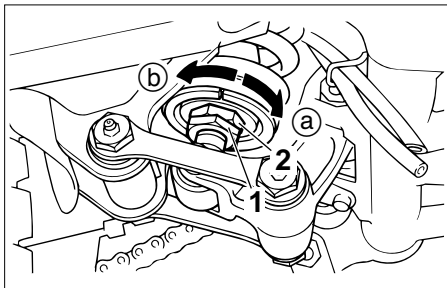

1. Locknut
2. Adjusting nut

EAU01650

Rear shock absorber adjustment

This shock absorber is equipped with a spring preload adjuster. Adjust spring preload as follows.

1. Loosen the locknut.
2. Turn the adjusting nut in direction (a) to increase spring preload and in direction (b) to decrease spring preload. The spring preload is determined by the spring set length.

Shortening the spring set length increases spring preload, lengthening the spring set length decreases spring preload.

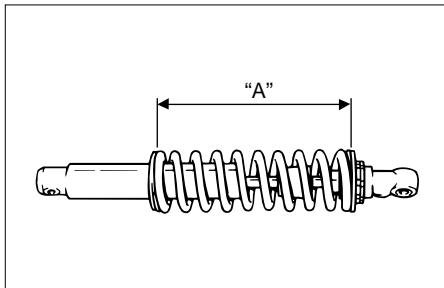

Spring preload:

Minimum (soft):

Distance "A" = 235 mm

Standard:

Distance "A" = 230 mm

Maximum (hard):

Distance "A" = 220 mm

EC000015

CAUTION: _____

Never attempt to turn an adjuster beyond the maximum or minimum setting.

3. Tighten the locknut to the specified torque.

Tightening torque:

Locknut:

55 Nm (5.5 m·kg)

EC000018

CAUTION: _____

Always tighten the locknut against the spring adjusting nut and tighten the locknut to the specified torque.

INSTRUMENT AND CONTROL FUNCTIONS

EAU00315

⚠WARNING

This shock absorber contains highly pressurized nitrogen gas. Read and understand the following information before handling the shock absorber. The manufacturer cannot be held responsible for property damage or personal injury that may result from improper handling.

- Do not tamper with or attempt to open the cylinder assembly.
- Do not subject the shock absorber to an open flame or other high heat source. This may cause the unit to explode due to excessive gas pressure.
- Do not deform or damage the cylinder in any way. Cylinder damage will result in poor damping performance.
- Take your shock absorber to a Yamaha dealer for any service.

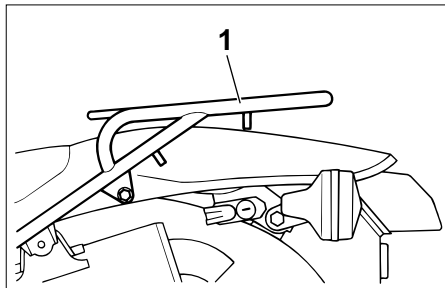

1. Rear carrier

EAU00320

Rear carrier

EW000032

⚠WARNING

Do not exceed the load limit of 2 kg.

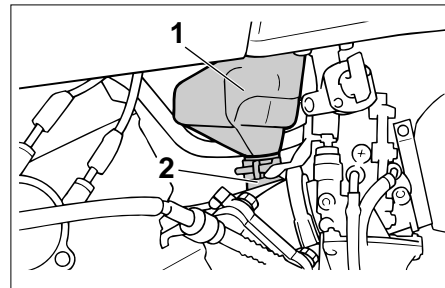

1. Air chamber
2. Hose

EAU00325

Note on handling of the Yamaha Energy Induction System (Y.E.I.S.)

Handle the air chamber and hose with special care. Improper installation or damaged parts will result in poor performance. Replace any cracked or damaged parts immediately. No modification of this system in any form can be made.

EC000022

CAUTION:

Never attempt to modify the Yamaha Energy Induction System.

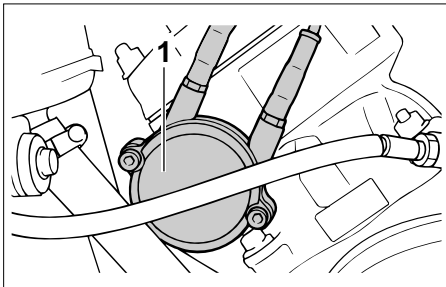

1. Y.P.V.S.

EAU00326

Y.P.V.S. (Yamaha Power Valve System)

The Y.P.V.S. is a vital part of the engine and requires very sophisticated adjustment. Adjustment should be left to a Yamaha dealer who has the professional knowledge and experience to do so.

EC000023

CAUTION:

The Y.P.V.S. was set at the Yamaha factory after many tests. If the settings are disturbed by someone without sufficient technical knowledge, poor engine performance and damage may result.

The Y.P.V.S. operation can be heard in the following instances:

- When the main switch is turned on and the engine is started.
- When the engine stalls while the main switch is on.

EC000024

CAUTION:

If the Y.P.V.S. does not operate, ask a Yamaha dealer to inspect the vehicle.

EAU00330

Sidestand

This model is equipped with an ignition circuit cut-off system. The motorcycle must not be ridden when the sidestand is down. The sidestand is located on the left side of the frame. (Refer to page 5-1 for an explanation of this system.)

INSTRUMENT AND CONTROL FUNCTIONS

⚠ WARNING

EW000044

This motorcycle must not be operated with the sidestand in the down position. If the stand is not properly retracted, it could contact the ground and distract the operator, resulting in a possible loss of control. Yamaha has designed into this motorcycle a lockout system to assist the operator in fulfilling the responsibility of retracting the sidestand. Please check carefully the operating instructions listed below and if there is any indication of a malfunction, return the motorcycle to a Yamaha dealer immediately for repair.

Sidestand switch operation check

EAU00333

Check the operation of the sidestand switch against the information below.

TURN THE MAIN SWITCH TO "ON" AND THE ENGINE STOP SWITCH TO "O".

TRANSMISSION IS IN NEUTRAL AND SIDESTAND IS DOWN.

KICK THE KICK STARTER.

ENGINE WILL START.

PULL IN THE CLUTCH LEVER AND PUT TRANSMISSION IN GEAR.

ENGINE WILL STALL.

SIDESTAND SWITCH IS OK.

⚠ WARNING

EW000045

If improper operation is noted, consult a Yamaha dealer immediately.

PRE-OPERATION CHECKS

Owners are personally responsible for their vehicle's condition. Your motorcycle's vital functions can start to deteriorate quickly and unexpectedly, even if it remains unused (for instance, if it is exposed to the elements). Any damage, fluid leak or loss of tire pressure could have serious consequences. Therefore, it is very important that, in addition to a thorough visual inspection, you check the following points before each ride.

PRE-OPERATION CHECK LIST

EAU00340

ITEM	CHECKS	PAGE
Front brake	<ul style="list-style-type: none"> • Check operation, free play, fluid level and vehicle for fluid leakage. • Fill with DOT 4 (or DOT 3) brake fluid if necessary. 	3-6, 6-21 ~ 6-25
Rear brake	<ul style="list-style-type: none"> • Check operation, free play, fluid level and vehicle for fluid leakage. • Fill with DOT 4 (or DOT 3) brake fluid if necessary. 	
Clutch	<ul style="list-style-type: none"> • Check operation, condition and free play. • Adjust if necessary. 	3-5, 6-21
Throttle grip and housing	<ul style="list-style-type: none"> • Check for smooth operation. • Lubricate. • Adjust throttle cable free play if necessary. 	6-17, 6-27
Engine oil	<ul style="list-style-type: none"> • Check oil level. • Fill with oil if necessary. 	3-9
Transmission oil	<ul style="list-style-type: none"> • Check oil level. • Fill with oil if necessary. 	6-11 ~ 6-12
Coolant	<ul style="list-style-type: none"> • Check coolant level. • Fill with coolant if necessary. 	6-12
Drive chain	<ul style="list-style-type: none"> • Check chain slack and condition. • Adjust if necessary. 	6-26 ~ 6-27
Wheels and tires	<ul style="list-style-type: none"> • Check tire pressure, wear, damage and spoke tightness. • Tighten spokes if necessary. 	6-18 ~ 6-20
Control and meter cable	<ul style="list-style-type: none"> • Check for smooth operation. • Lubricate if necessary. 	6-27

PRE-OPERATION CHECKS

ITEM	CHECKS	PAGE
Brake and shift pedal shafts	<ul style="list-style-type: none">• Check for smooth operation.• Lubricate if necessary.	6-28
Brake and clutch lever pivots	<ul style="list-style-type: none">• Check for smooth operation.• Lubricate if necessary.	
Sidestand pivot	<ul style="list-style-type: none">• Check for smooth operation.• Lubricate if necessary.	6-29
Chassis fasteners	<ul style="list-style-type: none">• Make sure that all nuts, bolts and screws are properly tightened.• Tighten if necessary.	—
Fuel tank	<ul style="list-style-type: none">• Check fuel level.• Fill with fuel if necessary.	3-6 ~ 3-8
Lights, signals and switches	<ul style="list-style-type: none">• Check for proper operation.	6-33 ~ 6-35
Battery	<ul style="list-style-type: none">• Check fluid level.• Fill with distilled water if necessary.	6-31 ~ 6-32

NOTE:

Pre-operation checks should be made each time the motorcycle is used. Such an inspection can be accomplished in a very short time; and the added safety it assures is more than worth the time involved.

⚠ WARNING

If any item in the Pre-Operation Check is not working properly, have it inspected and repaired before operating the motorcycle.

⚠ WARNING

EAU00373

- Before riding this motorcycle, become thoroughly familiar with all operating controls and their functions. Consult a Yamaha dealer regarding any control or function that you do not thoroughly understand.
- Never start your engine or let it run for any length of time in a closed area. The exhaust fumes are poisonous and can cause loss of consciousness and death within a short time. Always operate your motorcycle in an area with adequate ventilation.
- Before starting out, always be sure the sidestand is up. Failure to retract the sidestand completely can result in a serious accident when you try to turn a corner.

Starting the engine

EAU01177

NOTE:

This motorcycle is equipped with an ignition circuit cut-off system. The engine can be started only under one of the following conditions:

- The transmission is in neutral.
- The sidestand is up, the transmission is in gear and the clutch is disengaged.

The motorcycle must not be ridden when the sidestand is down.

⚠ WARNING

EW000056

Before going through the following steps, check the function of the sidestand switch. (Refer to page 3-16.)

OPERATION AND IMPORTANT RIDING POINTS

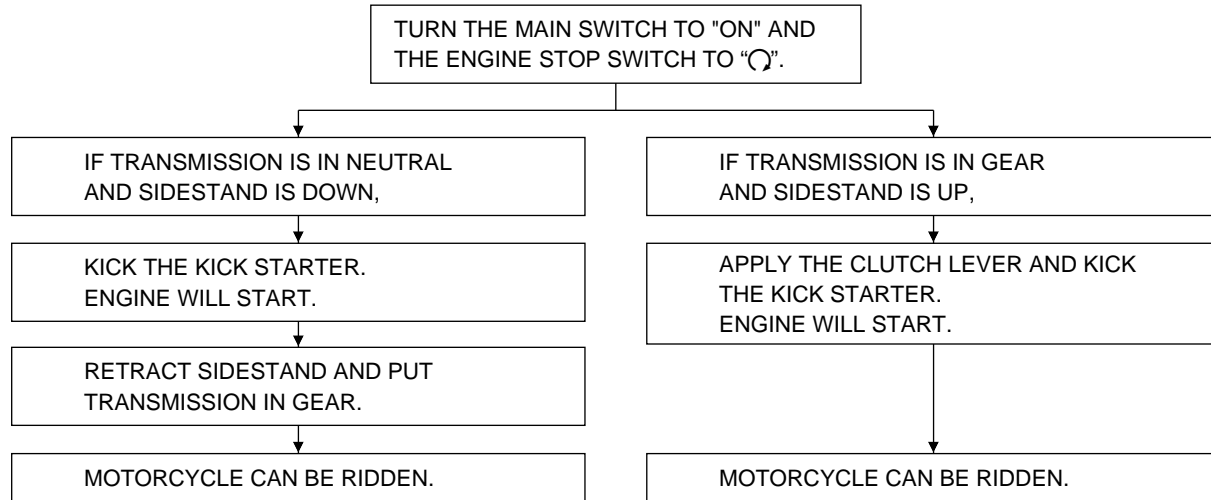

OPERATION AND IMPORTANT RIDING POINTS

1. Turn the fuel cock to “ON”.
2. Turn the main switch to “ON” and the engine stop switch to “”.
3. Shift the transmission into neutral.

NOTE: _____

When the transmission is in neutral, the neutral indicator light should be on. If the light does not come on, ask a Yamaha dealer to inspect it.

4. Turn on the starter (choke) and completely close the throttle grip.
5. Kick the kick starter to start the engine.
6. After starting the engine, move the starter (choke) to the halfway position.

NOTE: _____

For maximum engine life, never accelerate hard with a cold engine!

7. After the engine is warm, turn off the starter (choke) completely.

NOTE: _____

The engine is warm when it responds normally to the throttle with the starter (choke) turned off.

EAU01258

Starting a warm engine

The starter (choke) is not required when the engine is warm.

EC000046

CAUTION: _____

See the “Engine break-in” section prior to operating the motorcycle for the first time.

OPERATION AND IMPORTANT RIDING POINTS

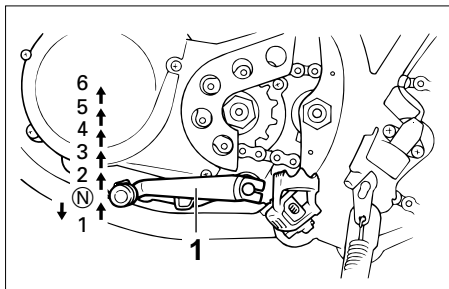

N. Neutral
1. Shift pedal

EAU00423

Shifting

The transmission lets you control the amount of power you have available at a given speed for starting, accelerating, climbing hills, etc. The use of the shift pedal is shown in the illustration.

To shift into neutral, depress the shift pedal repeatedly until it reaches the end of its travel, then raise the pedal slightly.

EC000048

CAUTION:

- Do not coast for long periods with the engine off, and do not tow the motorcycle a long distance. Even with gears in neutral, the transmission is only properly lubricated when the engine is running. Inadequate lubrication may damage the transmission.
- Always use the clutch when changing gears. The engine, transmission, and driveline are not designed to withstand the shock of forced shifting and can be damaged by shifting without using the clutch.

EAU02937

Recommended shift points (for Switzerland only)

The recommended shift points are shown in the table below.

	Acceleration shift point km/h
1st → 2nd	20
2nd → 3rd	30
3rd → 4th	40
4th → 5th	50
5th → 6th	60

NOTE:

When shifting two gears down from 5th to 3rd, bring your motorcycle to a speed of 35 km/h.

Tips for reducing fuel consumption

EAU00424

Your motorcycle's fuel consumption depends to a large extent on your riding style. The following tips can help reduce fuel consumption:

- Warm up the engine before riding.
- Turn off the starter (choke) as soon as possible.
- Shift up swiftly and avoid high engine speeds during acceleration.
- Do not double-clutch or rev the engine while shifting down and avoid high engine speeds with no load on the engine.
- Turn off the engine instead of letting it idle for an extended length of time, i.e. in traffic jams, at traffic lights or railroad crossings.

Engine break-in

EAU00436

There is never a more important period in the life of your motorcycle than the period between zero and 1,000 km. For this reason we ask that you carefully read the following material. Because the engine is brand new, you must not put an excessive load on it for the first 1,000 km. The various parts in the engine wear and polish themselves to the correct operating clearances. During this period, prolonged full throttle operation, or any condition which might result in excessive heating of the engine, must be avoided.

0 ~ 500 km

EAU00453

Avoid operation above 6,000 r/min. Stop the engine and let it cool for 5 to 10 minutes after every hour of operation. Vary the speed of the motorcycle from time to time. Do not operate it at one set throttle position.

500 ~ 1,000 km

Avoid prolonged operation above 7,000 r/min. Rev the motorcycle freely through the gears, but do not use full throttle at any time.

EC000060

CAUTION:

After 1,000 km of operation, be sure to replace the transmission oil.

OPERATION AND IMPORTANT RIDING POINTS

1,000 km and beyond

Full throttle can be used.

EC000053

CAUTION: _____

- Never let engine speeds enter the red zone.
 - If any engine trouble should occur during the break-in period, consult a Yamaha dealer immediately.
-

EAU00458

Parking

When parking the motorcycle, stop the engine and remove the ignition key. Turn the fuel cock to “OFF” whenever stopping the engine.

EW000058

⚠WARNING _____

The exhaust system is hot. Park the motorcycle in a place where pedestrians or children are not likely to touch the motorcycle. Do not park the motorcycle on a slope or soft ground; the motorcycle may overturn.

EC000062

CAUTION: _____

Never park this motorcycle in an area that would cause a fire hazard such as grass or other materials that may easily burn.

PERIODIC MAINTENANCE AND MINOR REPAIR

EAU00464

Periodic inspection, adjustment and lubrication will keep your motorcycle in the safest and most efficient condition possible. Safety is an obligation of the motorcycle owner. The maintenance and lubrication schedule chart should be considered strictly as a guide to general maintenance and lubrication intervals.

YOU MUST TAKE INTO CONSIDERATION THAT WEATHER, TERRAIN, GEOGRAPHICAL LOCATIONS, AND A VARIETY OF INDIVIDUAL USES ALL TEND TO DEMAND THAT EACH OWNER ALTER THIS TIME SCHEDULE TO SHORTER INTERVALS TO MATCH THE ENVIRONMENT. The most important points of motorcycle inspection, adjustment, and lubrication are explained in the following pages.

EW000060

⚠ WARNING

If you are not familiar with motorcycle service, this work should be done by a Yamaha dealer.

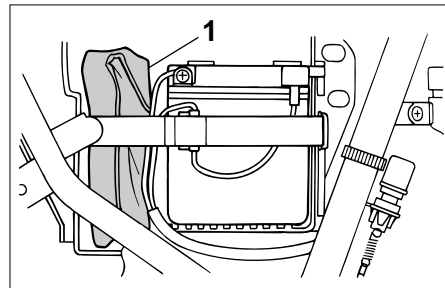

1. Tool kit

EAU00469

Tool kit

The service information included in this manual is intended to provide you, the owner, with the necessary information for completing some of your own preventive maintenance and minor repairs.

The tools provided in the owner's tool kit are to assist you in the performance of periodic maintenance. However, some other tools such as a torque wrench are also necessary to perform the maintenance correctly.

PERIODIC MAINTENANCE AND MINOR REPAIR

NOTE: _____

If you do not have necessary tools required during a service operation, take your motorcycle to a Yamaha dealer for service.

EW000063

⚠ WARNING _____

Modifications to this motorcycle not approved by Yamaha may cause loss of performance, and render it unsafe for use. Consult a Yamaha dealer before attempting any changes.

PERIODIC MAINTENANCE AND MINOR REPAIR

EAU03686

Periodic maintenance and lubrication chart

NOTE: _____

- The annual checks must be performed every year, except if a kilometer-based maintenance is performed instead.
- From 30,000 km, repeat the maintenance intervals starting from 6,000 km.
- Items marked with an asterisk should be performed by a Yamaha dealer as they require special tools, data and technical skills.

NO.	ITEM	CHECK OR MAINTENANCE JOB	ODOMETER READING (× 1,000 km)					ANNUAL CHECK
			1	6	12	18	24	
1	* Fuel line	• Check fuel hoses for cracks or damage.		√	√	√	√	√
2	Spark plug	• Replace.		√	√	√	√	√
3	Air filter element	• Clean.		√		√		
		• Replace.			√		√	
4	* Battery	• Check electrolyte level and specific gravity. • Make sure that the breather hose is properly routed.		√	√	√	√	√
5	Clutch	• Check operation. • Adjust.	√	√	√	√	√	
6	* Front brake	• Check operation, fluid level and vehicle for fluid leakage. (See NOTE on page 6-5.)	√	√	√	√	√	√
		• Replace brake pads.	Whenever worn to the limit					
7	* Rear brake	• Check operation, fluid level and vehicle for fluid leakage. (See NOTE on page 6-5.)	√	√	√	√	√	√
		• Replace brake pads.	Whenever worn to the limit					
8	* Brake hoses	• Check for cracks or damage.		√	√	√	√	√
		• Replace. (See NOTE on page 6-5.)	Every 4 years					

PERIODIC MAINTENANCE AND MINOR REPAIR

NO.	ITEM	CHECK OR MAINTENANCE JOB	ODOMETER READING (× 1,000 km)					ANNUAL CHECK
			1	6	12	18	24	
9	* Wheels	<ul style="list-style-type: none"> • Check runout, spoke tightness and for damage. • Tighten spokes if necessary. 		√	√	√	√	
10	* Tires	<ul style="list-style-type: none"> • Check tread depth and for damage. • Replace if necessary. • Check air pressure. • Correct if necessary. 		√	√	√	√	
11	* Wheel bearings	<ul style="list-style-type: none"> • Check bearing for looseness or damage. 		√	√	√	√	
12	* Swingarm	<ul style="list-style-type: none"> • Check operation and for excessive play. 		√	√	√	√	
13	Drive chain	<ul style="list-style-type: none"> • Check chain slack. • Make sure that the rear wheel is properly aligned. • Clean and lubricate. 	Every 500 km and after washing the motorcycle or riding in the rain.					
14	* Steering bearings	<ul style="list-style-type: none"> • Check bearing play and steering for roughness. • Lubricate with lithium-soap-based grease. 	√	√	√	√	√	
15	* Chassis fasteners	<ul style="list-style-type: none"> • Make sure that all nuts, bolts and screws are properly tightened. 		√	√	√	√	√
16	Sidestand	<ul style="list-style-type: none"> • Check operation. • Lubricate. 		√	√	√	√	√
17	* Sidestand switch	<ul style="list-style-type: none"> • Check operation. 	√	√	√	√	√	√
18	* Front fork	<ul style="list-style-type: none"> • Check operation and for oil leakage. 		√	√	√	√	
19	* Shock absorber assembly	<ul style="list-style-type: none"> • Check operation and shock absorber for oil leakage. 		√	√	√	√	
20	* Rear suspension relay arm and connecting arm pivoting points	<ul style="list-style-type: none"> • Check operation. 		√	√	√	√	

PERIODIC MAINTENANCE AND MINOR REPAIR

NO.	ITEM	CHECK OR MAINTENANCE JOB	ODOMETER READING (× 1,000 km)					ANNUAL CHECK
			1	6	12	18	24	
21	* Carburetor	<ul style="list-style-type: none"> • Check starter (choke) operation. • Adjust engine idling speed. 	√	√	√	√	√	√
22	* Autolube pump	<ul style="list-style-type: none"> • Check operation. • Bleed if necessary. 	√		√		√	√
23	Transmission oil	• Check oil level.	√	√	√	√	√	√
		• Change.	√				√	
24	* Cooling system	• Check coolant level and vehicle for coolant leakage.		√	√	√	√	√
		• Change.	Every 3 years					
25	* Front and rear brake switches	• Check operation.	√	√	√	√	√	√
26	Moving parts and cables	• Lubricate.		√	√	√	√	√
27	* Lights, signals and switches	<ul style="list-style-type: none"> • Check operation. • Adjust headlight beam. 	√	√	√	√	√	√

EAU03884

6

NOTE:

- The air filter needs more frequent service if you are riding in unusually wet or dusty areas.
- Hydraulic brake service
 - Regularly check and, if necessary, correct the brake fluid level.
 - Every two years replace the internal components of the brake master cylinders and calipers, and change the brake fluid.
 - Replace the brake hoses every four years and if cracked or damaged.

PERIODIC MAINTENANCE AND MINOR REPAIR

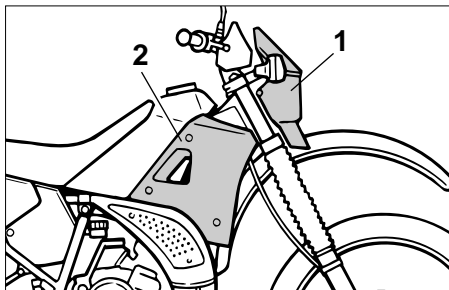

1. Cowling A
2. Cowling B

EAU01065

Cowling removal and installation

The cowlings indicated in the illustration need to be removed to perform some of the maintenance described in this chapter.

Refer to this section each time a cowling has to be removed or reinstalled.

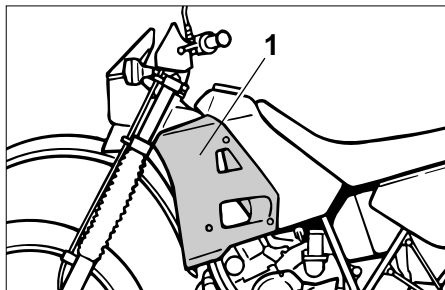

1. Cowling C

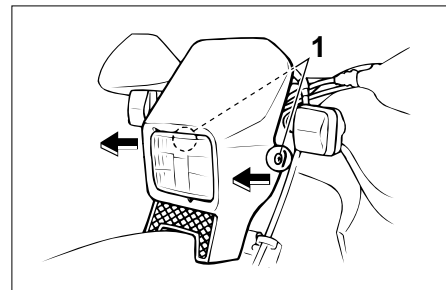

1. Screw (x2)

EAU01534*

Cowling A

To remove

Remove the screws and pull outward as shown.

PERIODIC MAINTENANCE AND MINOR REPAIR

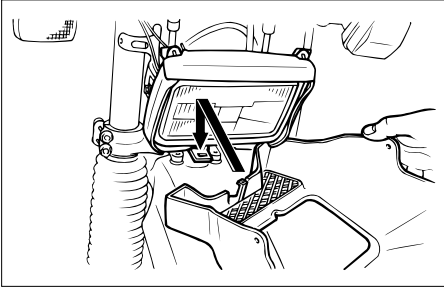

To install

Place in the original position and install the screws.

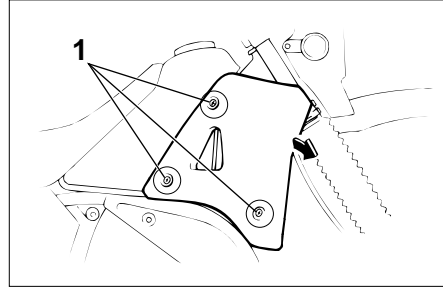

1. Screw (x3)

EAU01534*

Cowling B

To remove

Remove the screws and pull outward as shown.

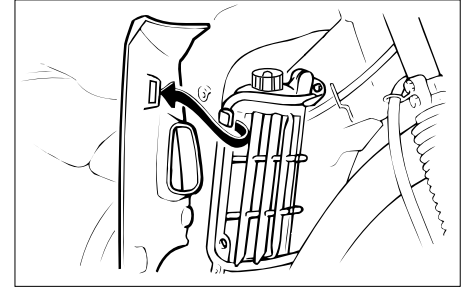

To install

Place in the original position and install the screws.

PERIODIC MAINTENANCE AND MINOR REPAIR

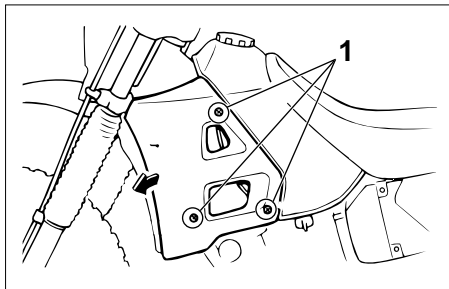

1. Screw (x3)

EAU01534*

Cowling C

To remove

Remove the screws and pull outward as shown.

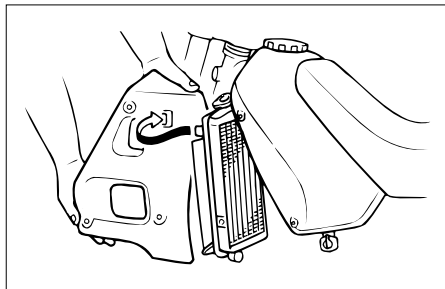

To install

Place in the original position and install the screws.

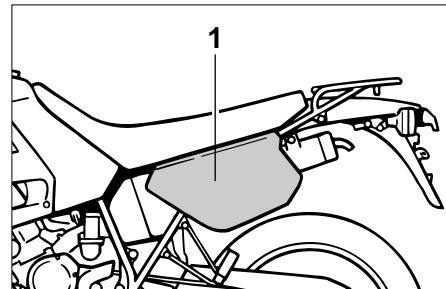

1. Panel D

EAU01122

Panel removal and installation

The panels illustrated need to be removed to perform some of the maintenance described in this chapter.

PERIODIC MAINTENANCE AND MINOR REPAIR

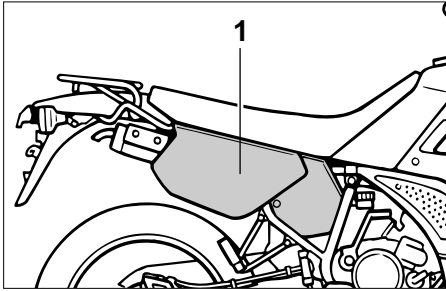

1. Panel E

Refer to this section each time a panel has to be removed or reinstalled.

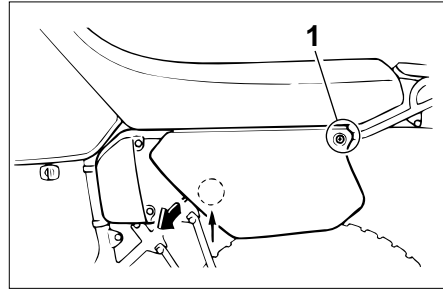

1. Screw

EAU01535*

Panel D

To remove

Remove the screw and pull outward as shown.

To install

Place the panel in the original position and install the screw.

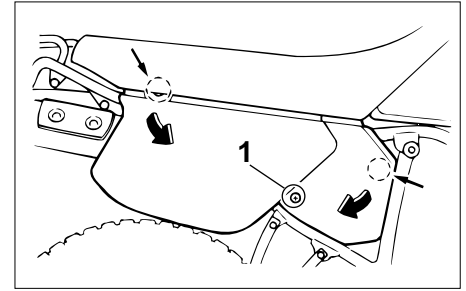

1. Screw

EAU01535*

Panel E

To remove

Remove the screw and pull outward as shown.

To install

Place the panel in the original position and install the screw.

PERIODIC MAINTENANCE AND MINOR REPAIR

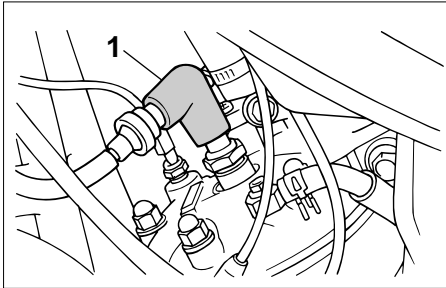

1. Spark plug cap

EAU01833

Spark plug Removal

1. Remove the spark plug cap.

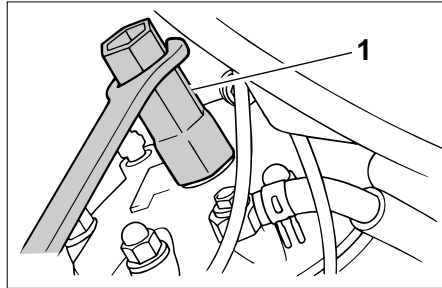

1. Spark plug wrench
2. Use the spark plug wrench in the tool kit to remove the spark plug as shown.

Inspection

The spark plug is an important engine component and is easy to inspect. The condition of the spark plug can indicate the condition of the engine.

The ideal color on the white insulator around the center electrode is a medium-to-light tan color for a motorcycle that is being ridden normally.

Do not attempt to diagnose such problems yourself. Instead, take the motorcycle to a Yamaha dealer. You should periodically remove and inspect the spark plug because heat and deposits will cause any spark plug to slowly break down and erode. If electrode erosion becomes excessive, or if carbon and other deposits are excessive, you should replace the spark plug with the specified plug.

Specified spark plug:

BR9ES (NGK)

BR8ES (NGK) (CH, A only)

PERIODIC MAINTENANCE AND MINOR REPAIR

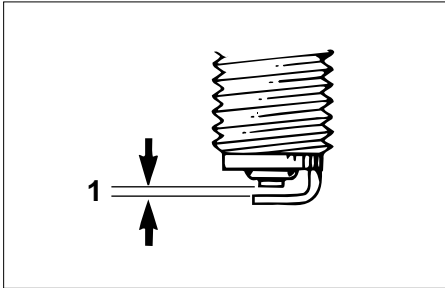

1. Spark plug gap

Installation

1. Measure the electrode gap with a wire thickness gauge and, if necessary, adjust the gap to specification.

Spark plug gap:
0.7 ~ 0.8 mm

2. Clean the gasket surface. Wipe off any grime from the threads.
3. Install the spark plug and tighten it to the specified torque.

Tightening torque:
Spark plug:
20 Nm (2.0 m·kg)

NOTE: _____
If a torque wrench is not available when you are installing a spark plug, a good estimate of the correct torque is 1/4 to 1/2 turn past finger tight. Have the spark plug tightened to the specified torque as soon as possible.

4. Install the spark plug cap.

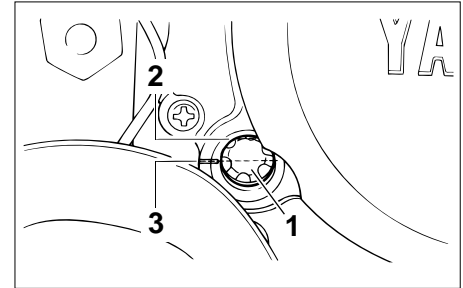

1. Level window
2. Maximum level
3. Minimum level

EAU03109

Transmission oil Oil level inspection

1. Place the motorcycle on a level place and hold it in an upright position. Warm up the engine for several minutes.

NOTE: _____
Be sure the motorcycle is positioned straight up when checking the oil level. A slight tilt toward the side can result in false readings.

PERIODIC MAINTENANCE AND MINOR REPAIR

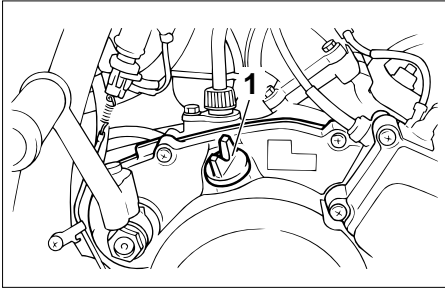

1. Oil filler cap

2. With the engine stopped, check the oil level through the level window located at the right side crankcase cover.

NOTE: _____
Wait a few minutes until the oil level settles before checking.

3. The oil level should be between the maximum and minimum level on the level window. If the level is low, add sufficient oil to raise it to the specified level.

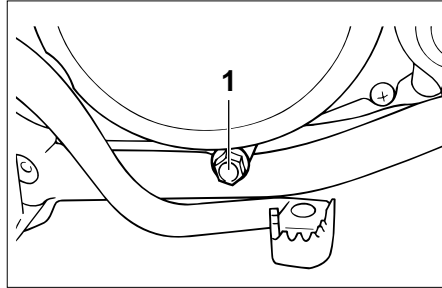

1. Drain bolt

Transmission oil replacement

1. Warm up the engine for several minutes.
2. Stop the engine. Place an oil pan under the engine to catch the oil and remove the oil filler cap.
3. Remove the drain bolt and drain the oil.
4. Install the drain bolt and tighten it to the specified torque.

Tightening torque:
Drain bolt:
15 Nm (1.5 m·kg)

5. Fill the engine with sufficient oil to reach the specified level. Install the oil filler cap and tighten it.

Recommended oil:

See page 8-1.

Oil quantity:

Total amount: 0.8 L

Periodic oil change: 0.75 L

EC000079

CAUTION: _____

Do not put in any chemical additives. Transmission oil also lubricates the clutch and additives could cause clutch slippage.

6. Start the engine and warm up for a few minutes. While warming up, check for oil leakage. If oil leakage is found, stop the engine immediately and check for cause.

PERIODIC MAINTENANCE AND MINOR REPAIR

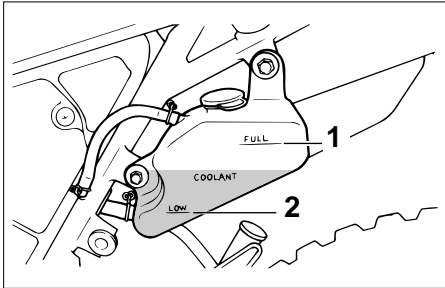

1. Maximum level mark
2. Minimum level mark

EAU01808

Cooling system

1. Remove panel D. (See page 6-9 for panel removal and installation procedures.)
2. Check the coolant level in the reservoir tank when the engine is cold as the coolant level will vary with engine temperature. The coolant level should be between the maximum and minimum marks.
3. If the level is low, add coolant or distilled water to raise it to the specified level.

4. Install the panel.

Reservoir tank capacity:
0.35 L

EC000080

CAUTION:

Hard water or salt water is harmful to the engine. You may use distilled water if you can't get soft water.

NOTE:

If water is added, have a Yamaha dealer check the antifreeze content of the coolant as soon as possible.

If your motorcycle overheats, see page 6-41 for details.

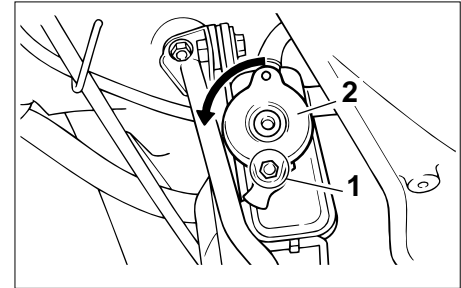

1. Stopper bolt
2. Radiator cap

EAU03101

Changing the coolant

1. Put the motorcycle on a level place.
2. Remove cowling C and panel D. (See page 6-8 ~ 6-9 for cowling and panel removal and installation procedures.)
3. Remove the radiator cap stopper bolt and the radiator cap.

PERIODIC MAINTENANCE AND MINOR REPAIR

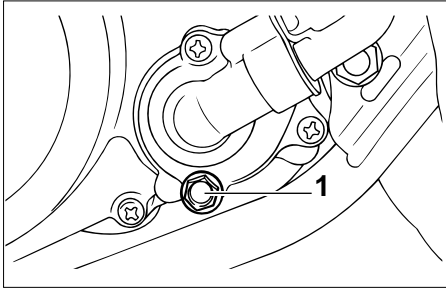

1. Drain bolt
4. Place a container under the engine and remove the coolant drain bolt.

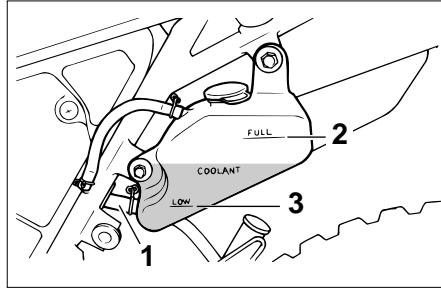

1. Reservoir tank hose
2. Maximum level mark
3. Minimum level mark
5. Disconnect the reservoir tank hose on the reservoir tank side and drain the coolant from the reservoir tank.
6. After draining the coolant, thoroughly flush the cooling system with clean tap water.
7. Replace the coolant drain bolt washer if it is damaged and tighten the coolant drain bolt to the specified torque.

Tightening torque:
Coolant drain bolt:
10 Nm (1.0 m·kg)

8. Install the reservoir tank hose.
9. Pour the recommended coolant into the radiator until it is full.

Recommended antifreeze:
High quality ethylene glycol antifreeze containing corrosion inhibitors for aluminum engines.
Antifreeze and water mixing ratio:
1:1
Total amount:
1.05 L
Reservoir tank capacity:
0.35 L

PERIODIC MAINTENANCE AND MINOR REPAIR

EC000080

CAUTION:

Hard water or salt water is harmful to the engine. You may use distilled water if you can't get soft water.

10. Install the radiator cap.
11. Run the engine several minutes. Stop the engine and recheck the coolant level in the radiator. If it is low, add more coolant until it reaches the top of the radiator.
12. Install the radiator cap stopper bolt.
13. Fill the reservoir tank with coolant up to maximum level.
14. Install the reservoir tank cap and check for coolant leakage.

NOTE:

If any leakage is found, ask a Yamaha dealer to inspect the cooling system.

15. Install the cowlings and the panel.

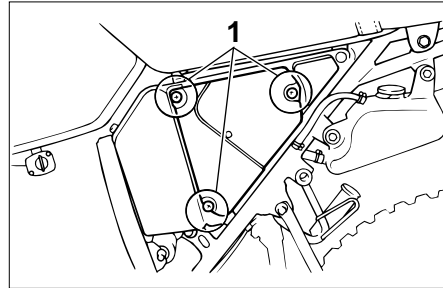

1. Screw (×3)

EAU03107

Air filter

The air filter should be cleaned at the specified intervals. It should be cleaned more frequently when riding in unusually wet or dusty areas.

1. Remove panel D. (See page 6-9 for panel removal and installation procedures.)
2. Remove the air filter case by removing the screws.

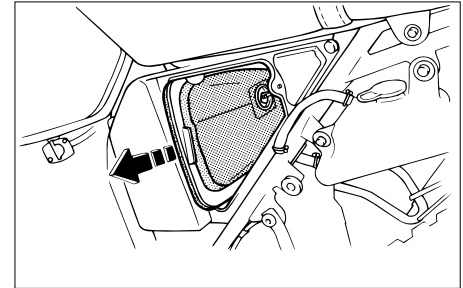

3. Remove the air filter from the case.

PERIODIC MAINTENANCE AND MINOR REPAIR

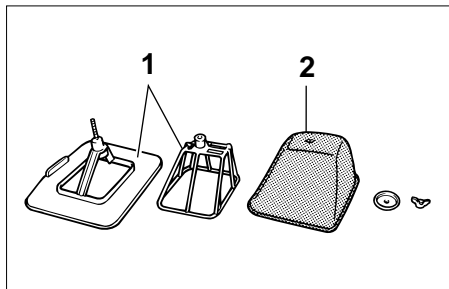

1. Guide
2. Filter element

4. Remove the air filter element from its guide and clean it with solvent. After cleaning, remove the remaining solvent by squeezing the element.
5. Apply recommended oil to the entire surface of the element and squeeze out the excess oil. It should be wet but not dripping.

Recommended oil:
Engine oil

6. Insert the air filter guide into the air filter and install it in the case.
7. Install the air filter case cover and panel by installing the screws.

EC000082

CAUTION:

- **Make sure the air filter is properly seated in the air filter case.**
- **The engine should never be run without the air filter installed. Excessive piston and/or cylinder wear may result.**

EAU00629

Carburetor adjustment

The carburetor is a vital part of the engine and requires very sophisticated adjustment. Most adjustments should be left to a Yamaha dealer who has the professional knowledge and experience to do so. However, the following may be serviced by the owner as part of routine maintenance.

EC000094

CAUTION:

The carburetor was set at the Yamaha factory after many tests. If the settings are changed, poor engine performance and damage may result.

PERIODIC MAINTENANCE AND MINOR REPAIR

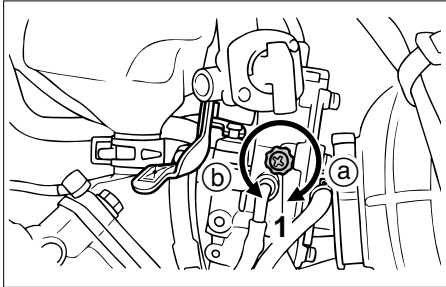

1. Throttle stop screw

EAU00632

Idle speed adjustment

1. Start the engine and warm it up for a few minutes at approximately 1,000 to 2,000 r/min. Occasionally rev the engine to 4,000 to 5,000 r/min. The engine is warm when it quickly responds to the throttle.
2. Set the idle to the specified engine speed by adjusting the throttle stop screw. Turn the screw in direction ① to increase engine speed and in direction ② to decrease engine speed.

Standard idle speed:
1,250 ~ 1,450 r/min

NOTE: _____
If the specified idle speed cannot be obtained by performing the above adjustment, consult a Yamaha dealer.

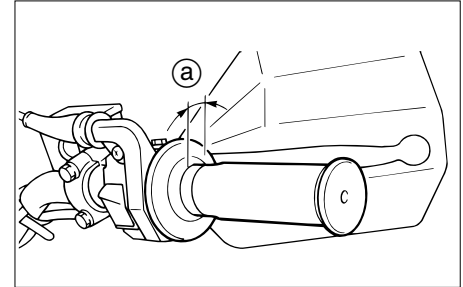

- a. Free play

EAU00634

Throttle cable free play adjustment

NOTE: _____
Before checking the throttle cable free play, the engine idling speed should be adjusted.

Adjust the throttle cable by turning the adjusting nut so that specified free play at the throttle grip is obtained.

Free play:
3 ~ 5 mm

PERIODIC MAINTENANCE AND MINOR REPAIR

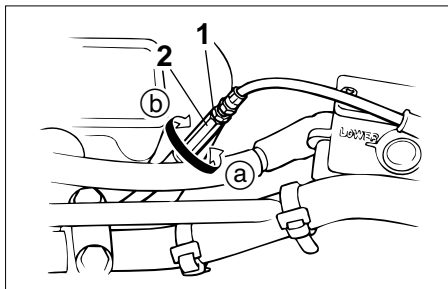

1. Locknut
2. Adjusting nut

1. Loosen the locknut.
2. Turn the adjusting nut in direction (a) to increase free play and in direction (b) to decrease free play.
3. Tighten the locknut.

EAU00652

Tires

To ensure maximum performance, long service and safe operation, note the following:

Tire air pressure

Always check and adjust the tire pressure before operating the motorcycle.

EW000082

⚠ WARNING

Tire inflation pressure should be checked and adjusted when the temperature of the tire equals the ambient air temperature. Tire inflation pressure must be adjusted according to total weight of cargo, rider, passenger, and accessories (fairing, saddlebags, etc. if approved for this model), and vehicle speed.

Maximum load*	180 kg	
	178 kg (CH, A only)	
Cold tire pressure	Front	Rear
Up to 90 kg	125 kPa (1.25 kg/cm ² , 1.25 bar)	150 kPa (1.50 kg/cm ² , 1.50 bar)
90 kg load ~ Maximum load*	150 kPa (1.50 kg/cm ² , 1.50 bar)	175 kPa (1.75 kg/cm ² , 1.75 bar)
Off-road riding	125 kPa (1.25 kg/cm ² , 1.25 bar)	150 kPa (1.50 kg/cm ² , 1.50 bar)

* Load is the total weight of cargo, rider, passenger and accessories.

PERIODIC MAINTENANCE AND MINOR REPAIR

EW000083

⚠ WARNING

Proper loading of your motorcycle is important for several characteristics of your motorcycle, such as handling, braking, performance and safety. Do not carry loosely packed items that can shift. Securely pack your heaviest items close to the center of the motorcycle, and distribute the weight evenly from side to side. Properly adjust the suspension for your load, and check the condition and pressure of your tires. **NEVER OVERLOAD YOUR MOTORCYCLE.** Make sure the total weight of the cargo, rider, passenger, and accessories (fairing, saddlebags, etc. if approved for this model) does not exceed the maximum load of the motorcycle. Operation of an overloaded motorcycle could cause tire damage, an accident, or even injury.

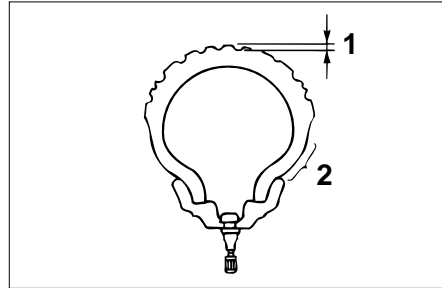

1. Tread depth
2. Side wall

Tire inspection

Always check the tires before operating the motorcycle. If center tread depth reaches the limit as shown, if the tire has a nail or glass fragments in it, or if the side wall is cracked, contact a Yamaha dealer immediately and have the tire replaced.

EW000078

⚠ WARNING

After extensive tests, the tires mentioned below have been approved by Yamaha Motor Co., Ltd. for this model. No guarantee for handling characteristics can be given if tire combinations other than what is approved are used on this motorcycle. The front and rear tires should be of the same manufacture and design.

FRONT

Manufacturer	Size	Type
BRIDGESTONE	2.75-21 45P	TW25

REAR

Manufacturer	Size	Type
BRIDGESTONE	4.10-18 59P	TW44

Minimum tire tread depth (front and rear)	1.6 mm
-------------------------------------------	--------

PERIODIC MAINTENANCE AND MINOR REPAIR

NOTE: _____

These limits may be different by regulation from country to country. If so, conform to the limits specified by the regulations of your own country.

⚠ WARNING _____

EAU00681

- **Operating the motorcycle with excessively worn tires decrease riding stability and can lead to loss of control. Have excessively worn tires replaced by a Yamaha dealer immediately. Brakes, tires, and related wheel parts replacement should be left to a Yamaha Service Technician.**
 - **Patching a punctured tube is not recommended. If it is absolutely necessary to do so, use great care and replace the tube as soon as possible with a good quality replacement.**
-

EAU00685

Wheels

To ensure maximum performance, long service, and safe operation, note the following:

- Always inspect the wheels before a ride. Check for cracks, bends or warpage of the wheel. Be sure the spokes are tight and undamaged. If any abnormal condition exists in a wheel, consult a Yamaha dealer. Do not attempt even small repairs to the wheel. If a wheel is deformed or cracked, it must be replaced.
- Tires and wheels should be balanced whenever either one is changed or replaced. Failure to have a wheel balanced can result in poor performance, adverse handling characteristics, and shortened tire life.
- Ride at moderate speeds after changing a tire since the tire surface must first be broken in for it to develop its optimal characteristics.

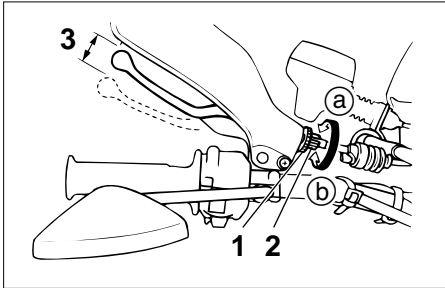

1. Locknut
2. Adjusting bolt
3. Free play

EAU00694

Clutch lever free play adjustment

The clutch lever free play should be adjusted to 10 ~ 15 mm.

1. Loosen the locknut at the clutch lever.
2. Turn the adjusting bolt at the clutch lever in direction (a) to increase free play or in direction (b) to decrease free play.
3. Tighten the locknut at the clutch lever.

If the specified free play cannot be obtained, proceed with the following steps.

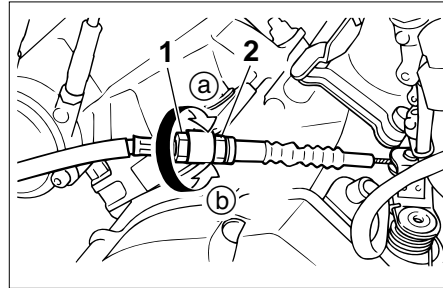

1. Locknut
2. Adjusting nut
4. Loosen the locknut at the clutch lever.
5. Turn the adjusting bolt at the clutch lever in direction (a) to loosen the cable.
6. Loosen the locknut at the crankcase side.
7. Turn the adjusting nut at the crankcase in direction (a) to increase free play or in direction (b) to decrease free play.
8. Tighten the locknut at the crankcase and the clutch lever.

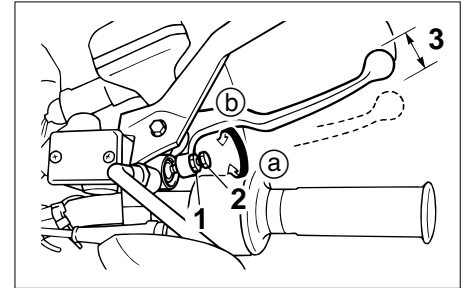

1. Locknut
2. Adjusting bolt
3. Free play

EAU00696

Front brake lever free play adjustment

The free play at the front brake lever should be 2 ~ 5 mm.

1. Loosen the locknut.
2. Turn the adjusting bolt in direction (a) to increase free play or in direction (b) to decrease free play.
3. After adjusting, tighten the locknut.

PERIODIC MAINTENANCE AND MINOR REPAIR

⚠ WARNING

EW000099

- Check the brake lever free play. Be sure the brake is working properly.
- A soft or spongy feeling in the brake lever can indicate the presence of air in the brake system. This air must be removed by bleeding the brake system before the motorcycle is operated. Air in the system will cause greatly diminished braking capability and can result in loss of control and an accident. Have a Yamaha dealer inspect and bleed the system if necessary.

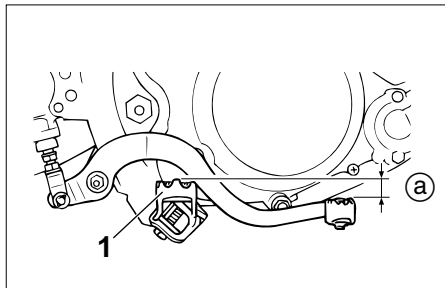

1. Footrest
- a. Pedal height

EAU00712

Rear brake pedal height adjustment

The top of the brake pedal should be positioned 15 mm below the top of the footrest. If not, ask a Yamaha dealer to adjust it.

⚠ WARNING

EW000109

A soft or spongy feeling in the brake pedal can indicate the presence of air in the brake system. This air must be removed by bleeding the brake system before the motorcycle is operated. Air in the system will cause greatly diminished braking capability and can result in loss of control and an accident. Have a Yamaha dealer inspect and bleed the system if necessary.

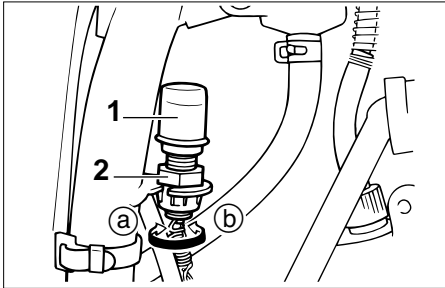

1. Brake light switch
2. Adjusting nut

EAU00713

Brake light switch adjustment

The rear brake light switch is activated by the brake pedal and is properly adjusted when the brake light comes on just before braking takes effect. To adjust the rear brake light switch, hold the switch body so it does not rotate while turning the adjusting nut. Turn the adjusting nut in direction (a) to make the brake light come on earlier. Turn the adjusting nut in direction (b) to make the brake light come on later.

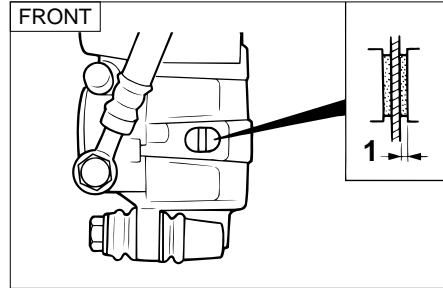

1. Wear limit: 0.8 mm

EAU00717

Checking the front and rear brake pads

Check the brake pads for damage and wear. If the thickness is less than the specified value, have a Yamaha dealer replace the pads.

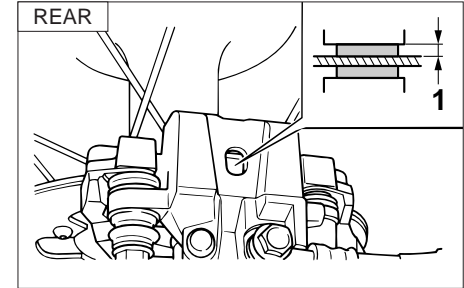

1. Wear limit: 0.8 mm

PERIODIC MAINTENANCE AND MINOR REPAIR

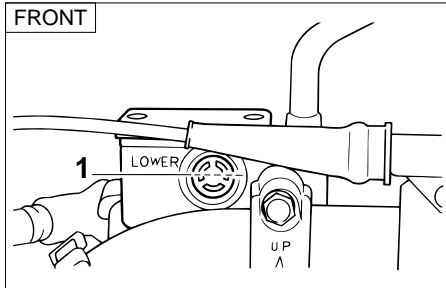

1. Minimum level mark

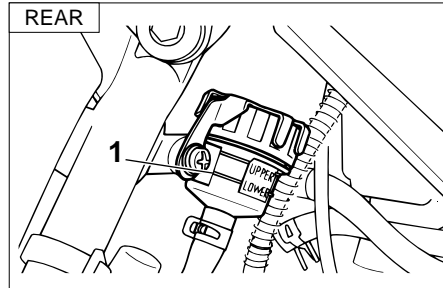

1. Minimum level mark

Inspecting the brake fluid level

EAU00732

Insufficient brake fluid may let air enter the brake system, possibly causing the brakes to become ineffective.

Before riding, check that the brake fluid is above the minimum level and fill when necessary.

Observe these precautions:

- When checking the fluid level, make sure the top of the master cylinder is level by turning the handlebars.

- Use only the designated quality brake fluid. Otherwise, the rubber seals may deteriorate, causing leakage and poor brake performance.

Recommended brake fluid:
DOT 4

NOTE: _____

If DOT 4 is not available, DOT 3 can be used.

- Refill with the same type of brake fluid. Mixing fluids may result in a harmful chemical reaction and lead to poor brake performance.
- Be careful that water does not enter the master cylinder when refilling. Water will significantly lower the boiling point of the fluid and may result in vapor lock.
- Brake fluid may deteriorate painted surfaces or plastic parts. Always clean up spilled fluid immediately.
- Have a Yamaha dealer check the cause if the brake fluid level goes down.

PERIODIC MAINTENANCE AND MINOR REPAIR

Brake fluid replacement

EAU00742

The brake fluid should be replaced only by trained Yamaha service personnel. Have the Yamaha dealer replace the following components during periodic maintenance or when they are damaged or leaking:

- oil seals (every two years)
- brake hoses (every four years)

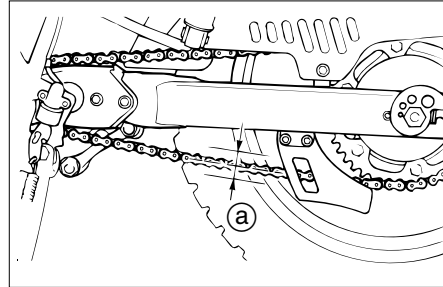

a. Chain slack

To check the chain slack the motorcycle must be held straight up with both wheels on the ground and without rider. Check the slack at the position shown in the illustration. Normal slack is approximately 25 ~ 40 mm. If the slack exceeds 40 mm, adjust it.

Drive chain slack check

EAU00744*

NOTE:

Spin the wheel several times and find the tightest position of the chain. Check and/or adjust the chain slack while it's in this tightest position.

PERIODIC MAINTENANCE AND MINOR REPAIR

EC000096

EAU03006

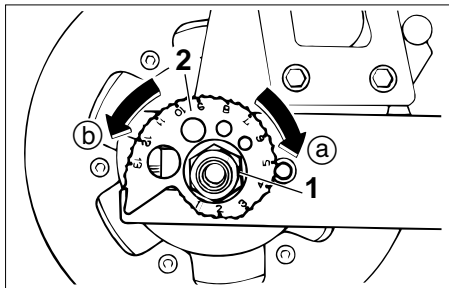

1. Wheel axle nut
2. Chain adjusting plate

EAU01533*

Drive chain slack adjustment

1. Loosen the wheel axle nut.
2. To tighten the chain, turn the chain adjusting plates in direction (a). To loosen the chain, turn the chain adjusting plates in direction (b) and push the wheel forward. Turn each chain adjusting plate to exactly the same position to maintain correct axle alignment.

CAUTION: _____

Too little chain slack will overload the engine and other vital parts. Keep the slack within the specified limits.

3. Tighten the wheel axle nut to the specified torque.

Tightening torque:

Wheel axle nut:
90 Nm (9.0 m·kg)

Drive chain lubrication

The chain consists of many parts which work with each other. If the chain is not maintained properly, it will wear out quickly. Therefore, the chain must be serviced regularly. This service is especially necessary when riding in dusty areas. This motorcycle is equipped with a sealed type chain. Steam cleaning, high-pressure washers, and solvents can damage the drive chain, so do not use these for cleaning it. Use only kerosene to clean the drive chain. Wipe it dry, and thoroughly lubricate it with SAE 30 ~ 50W motor oil. Do not use any other lubricants on the drive chain. They may contain solvents that could damage the sealed chain.

PERIODIC MAINTENANCE AND MINOR REPAIR

CAUTION:

EC000097

Be sure to oil the chain after washing the motorcycle or riding in the rain.

Cable inspection and lubrication

EAU02962

⚠ WARNING

EW000112

Damage to the outer housing of cables may lead to internal rusting and interfere with the cable movement. Replace damaged cables as soon as possible to prevent unsafe conditions.

Lubricate the cables and cable ends. If a cable does not operate smoothly, ask a Yamaha dealer to replace it.

Recommended lubricant:
Engine oil

Throttle cable and grip lubrication

EAU00773

The throttle twist grip assembly should be greased at the time that the cable is lubricated, since the grip must be removed to get at the end of the throttle cable. After removing the screws, hold the end of the cable up in the air and put in several drops of lubricant. With the throttle grip disassembled, coat the metal surface of the grip assembly with a suitable all-purpose grease.

PERIODIC MAINTENANCE AND MINOR REPAIR

EAU00774

Autolube pump adjustment

The autolube pump is a vital part of the engine and requires very sophisticated adjustment.

Adjusting should be left to a Yamaha dealer who has the professional knowledge and experience to do so.

EAU02984

Brake and shift pedal lubrication

Lubricate the pivoting parts.

Recommended lubricant:
Engine oil

EAU02985

Brake and clutch lever lubrication

Lubricate the pivoting parts.

Recommended lubricant:
Engine oil

PERIODIC MAINTENANCE AND MINOR REPAIR

Sidestand lubrication

EAU02986

Lubricate the sidestand pivoting point and metal-to-metal contact surfaces. Check that the sidestand moves up and down smoothly.

Recommended lubricant:
Engine oil

⚠ WARNING

EW000113

If the sidestand does not move smoothly, consult a Yamaha dealer.

Front fork inspection

EAU02939

Visual check

EW000115

⚠ WARNING

Securely support the motorcycle so there is no danger of it falling over.

Check for scratches or damage on the inner tube and excessive oil leakage from the front fork.

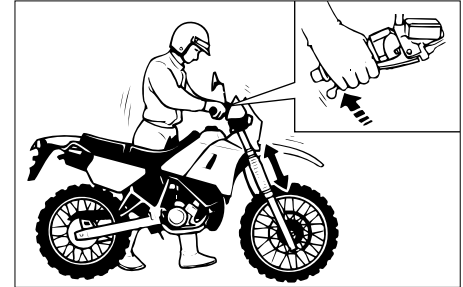

Operation check

1. Place the motorcycle on a level place.
2. Hold the motorcycle in an upright position and apply the front brake.
3. Push down hard on the handlebars several times and check if the fork rebounds smoothly.

CAUTION:

EC000098

If any damage or unsmooth movement is found with the front fork, consult a Yamaha dealer.

PERIODIC MAINTENANCE AND MINOR REPAIR

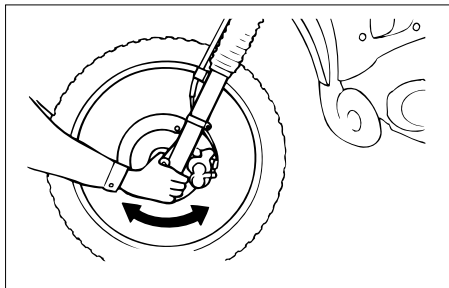

EAU00794

Steering inspection

Periodically inspect the condition of the steering. Worn out or loose steering bearings may be dangerous. Place a stand under the engine to raise the front wheel off the ground. Hold the lower end of the front forks and try to move them forward and backward. If any free play can be felt, ask a Yamaha dealer to inspect and adjust the steering. Inspection is easier if the front wheel is removed.

EW000115

⚠WARNING

Securely support the motorcycle so there is no danger of it falling over.

EAU01144

Wheel bearings

If there is play in the front or rear wheel hub or if the wheel does not turn smoothly, have a Yamaha dealer inspect the wheel bearings.

PERIODIC MAINTENANCE AND MINOR REPAIR

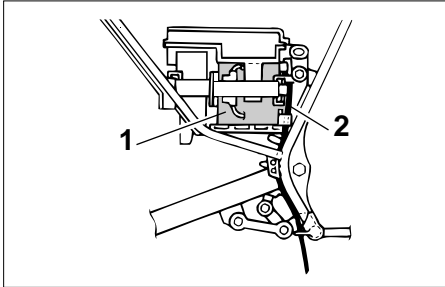

1. Battery
2. Battery breather hose

EAU01071

Battery

Check the level of the battery electrolyte and make sure that the terminals are tight.

Fill with distilled water if the electrolyte level is low.

EC000099

CAUTION:

When inspecting the battery, be sure the breather hose is routed correctly. If the breather hose is positioned in such a way as to cause battery electrolyte or gas to exit onto the frame, structural and cosmetic damage to the motorcycle can occur.

EW000116

WARNING

Battery electrolyte is poisonous and dangerous, causing severe burns, etc. It contains sulfuric acid. Avoid contact with skin, eyes or clothing.

ANTIDOTE:

- **EXTERNAL:** Flush with water.
- **INTERNAL:** Drink large quantities of water or milk. Follow with milk of magnesia, beaten egg, or vegetable oil. Call a physician immediately.
- **EYES:** Flush with water for 15 minutes and get prompt medical attention.

Batteries produce explosive gases. Keep sparks, flame, cigarettes etc., away. Ventilate when charging or using in an enclosed space. Always shield your eyes when working near batteries.

KEEP OUT OF REACH OF CHILDREN.

PERIODIC MAINTENANCE AND MINOR REPAIR

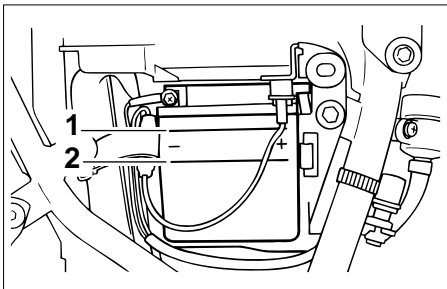

1. Maximum level mark
2. Minimum level mark

Replenishing the battery fluid

A poorly maintained battery will corrode and discharge quickly. The battery fluid should be checked at least once a month. The level should be between the minimum level and maximum level marks. Use only distilled water if refilling is necessary.

EC000100

CAUTION: _____

Normal tap water contains minerals which are harmful to a battery; therefore, refill only with distilled water.

EW000117

⚠ WARNING _____

Take care not to spill battery fluid on the chain.

Battery fluid may weaken the chain causing shorter chain life and possibly result in an accident.

Battery storage

- When the motorcycle will not be used for a month or longer, remove the battery, fully charge it and store it in a cool, dry place. Completely recharge the battery before reinstallation.
- If the battery will be stored for longer than two months, check the specific gravity of the fluid at least once a month and fully recharge the battery when it is too low.
- Always make sure the connections are correct when putting the battery back in the motorcycle. Make sure the breather hose is properly connected and is not damaged or obstructed.

PERIODIC MAINTENANCE AND MINOR REPAIR

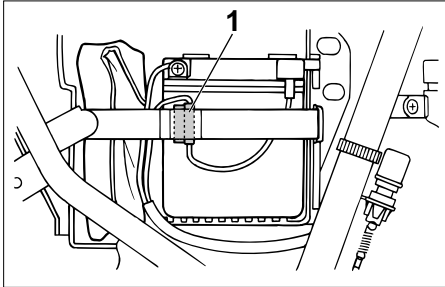

1. Fuse

EAU00804

Fuse replacement

If the fuse is blown, turn off the main switch and the switch of the circuit in question. Install a new fuse of specified amperage. Turn on the switches and see if the electrical device operates. If the fuse immediately blows again, consult a Yamaha dealer.

EC000103

CAUTION:

Do not use fuses of higher amperage rating than those recommended. Substitution of a fuse of improper rating can cause extensive electrical system damage and possibly a fire.

Specified fuse:
10 A

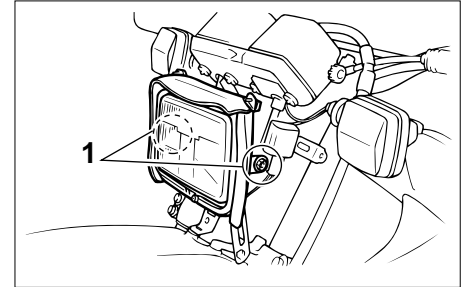

1. Bolt (x2)

EAU01158

Headlight bulb replacement

If the headlight bulb burns out, replace the bulb as follows:

1. Remove cowling A. (See page 6-6 ~ 6-7 for removal and installation procedures.)
2. Remove the headlight unit by removing the bolts.

PERIODIC MAINTENANCE AND MINOR REPAIR

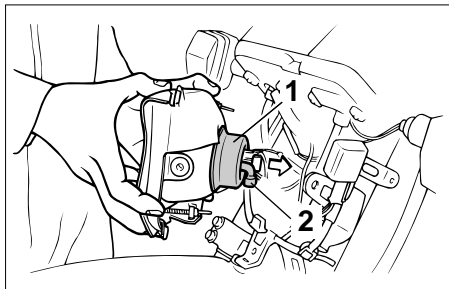

1. Bulb holder cover
2. Connector
3. Remove the headlight connector and the bulb holder cover.

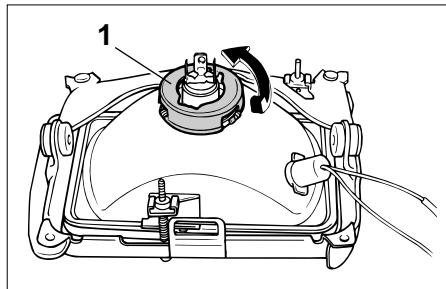

1. Bulb holder
4. Turn the bulb holder counter-clockwise to remove it and then remove the defective bulb.

EW000119

⚠ WARNING

Keep flammable products and your hands away from a bulb while it is on, as it is hot. Do not touch a bulb until it cools down.

5. Put a new bulb into position and secure it in place with the bulb holder.

6. Install the bulb holder cover, connector and headlight unit.
7. Install the cowling.
8. If the headlight beam adjustment is necessary, ask a Yamaha dealer to make that adjustment.

PERIODIC MAINTENANCE AND MINOR REPAIR

EC000108

CAUTION:

Do not over-tighten the screws as the lens may break.

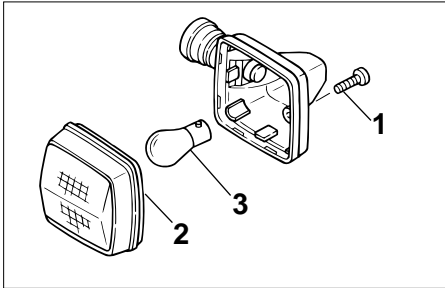

1. Screw
2. Lens
3. Bulb

EAU01095

Turn signal light bulb replacement

1. Remove the screw and the lens.
2. Remove the defective bulb by pushing it inward and turning it counterclockwise.
3. Install a new bulb by pushing it inward and turning it clockwise.
4. Install the lens and tighten the screw.

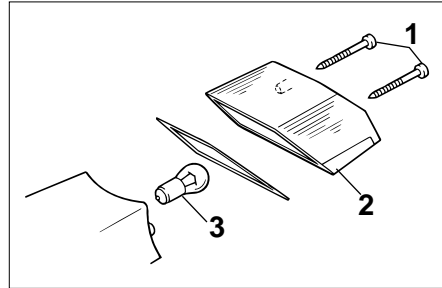

1. Screw (x2)
2. Lens
3. Bulb

EAU01623*

Tail/brake light bulb replacement

1. Remove the screws and the lens.
2. Remove the defective bulb by pushing it inward and turning it counterclockwise.
3. Install a new bulb by pushing it inward and turning it clockwise.
4. Install the lens and tighten the screws.

PERIODIC MAINTENANCE AND MINOR REPAIR

EAU01579

Supporting the motorcycle

Since the Yamaha DT125R has no centerstand, follow these precautions when removing the front and rear wheel or performing other maintenance requiring the motorcycle to stand upright. Check that the motorcycle is in a stable and level position before starting any maintenance. A strong wooden box can be placed under the engine for added stability.

Front wheel service

To stabilize the rear of the motorcycle, either use a motorcycle stand or place a motorcycle jack under the frame in front of the rear wheel to prevent it from moving from side to side. Then use a motorcycle stand to elevate the front wheel off of the ground.

Rear wheel service

Use a motorcycle stand or motorcycle jack to elevate the motorcycle so the rear wheel is off the ground. Alternatively, two jacks can be placed under the frame or swingarm.

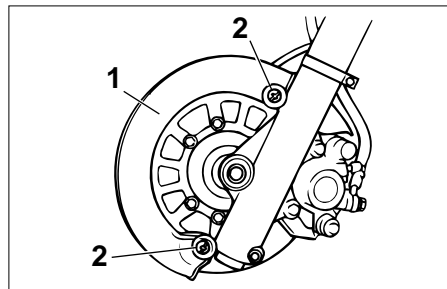

1. Disc cover
2. Screw (x2)

EAU00898

Front wheel removal

EW000122

⚠ WARNING

- It is advisable to have a Yamaha dealer service the wheel.
- Securely support the motorcycle so there is no danger of it falling over.

1. Remove the disc cover.
2. Remove the speedometer cable from the front wheel side.

PERIODIC MAINTENANCE AND MINOR REPAIR

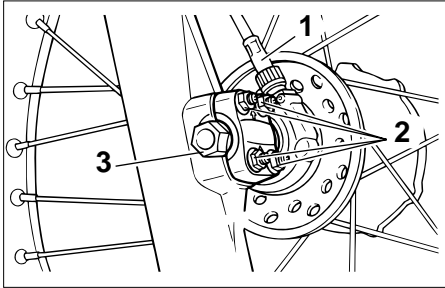

1. Speedometer cable
2. Axle holder nut (×4)
3. Wheel axle

3. Elevate the front wheel by placing a suitable stand under the engine.
4. Loosen the wheel axle holder nuts.
5. Remove the wheel axle and the front wheel. Make sure the motorcycle is properly supported.

NOTE:

Do not depress the brake lever when the disc and caliper are separated.

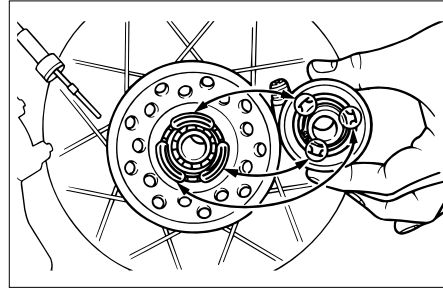

EAU03104

Front wheel installation

1. Install the speedometer gear unit housing into the wheel hub. Make sure the speedometer gear unit housing is installed with the projections meshed into the slots.
2. Lift up the wheel between the front fork legs and guide the brake disc between the brake pads. Make sure there is enough gap between the brake pads before inserting the brake disc.

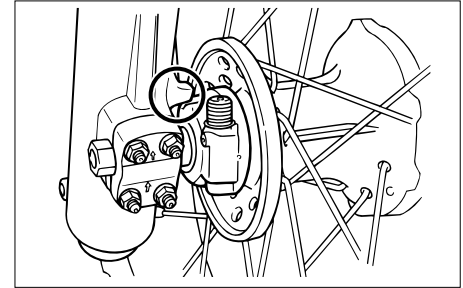

3. Make sure the slot in the speedometer gear unit fits over the stopper on the front fork outer tube.
4. Install the wheel axle and let the motorcycle down.
5. Tighten the wheel axle the specified torque.

Tightening torque:

Wheel axle:

58 Nm (5.8 m·kg)

PERIODIC MAINTENANCE AND MINOR REPAIR

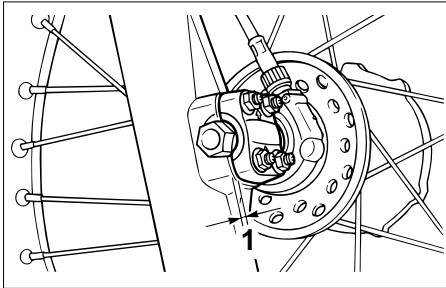

1. Gap
6. Tighten the axle holder nuts to the specified tightening torque. Tighten the upper nuts first and then lower ones. When tightened in this sequence, there should be a gap formed at the bottom of the axle holder.

Tightening torque:
Axle holder nut:
10 Nm (1.0 m·kg)

7. After tightening the holder nuts, push down on the handlebars several times and check if the fork rebounds smoothly.

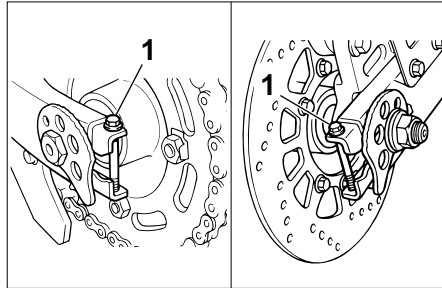

1. Swingarm end bolt (x2)

EAU03105

Rear wheel removal

EW000122

⚠ WARNING

- It is advisable to have a Yamaha dealer service the wheel.
- Securely support the motorcycle so there is no danger of it falling over.

1. Loosen the rear axle nut.
2. Elevate the rear wheel by placing a suitable stand under the engine.
3. Remove the swingarm end bolts.

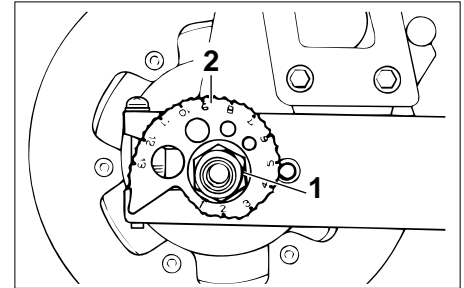

1. Axle nut
2. Chain adjusting plate
4. Remove the axle nut.
5. Push the wheel forward and remove the drive chain.
6. Pull out the rear axle and remove the wheel assembly by pulling backward.

NOTE:

- Do not depress the brake pedal when the disc and caliper are separated.
- You do not have to disassemble the chain in order to remove or install the rear wheel.

EAU03106

Rear wheel installation

1. Install the rear wheel and chain.
Guide the brake disc between the brake pads. Make sure there is enough gap between the brake pads before inserting the brake disc.
2. Make sure the wheel axle is inserted from the left side and that the chain adjusting plates are installed with the punched side outward.
3. Install the swingarm end bolts.
4. Adjust the drive chain.
5. Tighten the following parts to the specified torques.

Tightening torque:

Axle nut:

90 Nm (9.0 m·kg)

Swingarm end bolt:

3 Nm (0.3 m·kg)

EAU01008

Troubleshooting

Although Yamaha motorcycles receive a rigid inspection before shipment from the factory, trouble may occur during operation.

Any problem in the fuel, compression, or ignition systems can cause poor starting and loss of power. The troubleshooting chart describes a quick, easy procedure for making checks.

If your motorcycle requires any repair, bring it to a Yamaha dealer. The skilled technicians at a Yamaha dealership have the tools, experience, and know-how to properly service your motorcycle. Use only genuine Yamaha parts on your motorcycle. Imitation parts may look like Yamaha parts, but they are often inferior. Consequently, they have a shorter service life and can lead to expensive repair bills.

PERIODIC MAINTENANCE AND MINOR REPAIR

Troubleshooting charts

EAU03108

EW000125

⚠️WARNING

Never check the fuel system while smoking or in the vicinity of an open flame.

1. Fuel

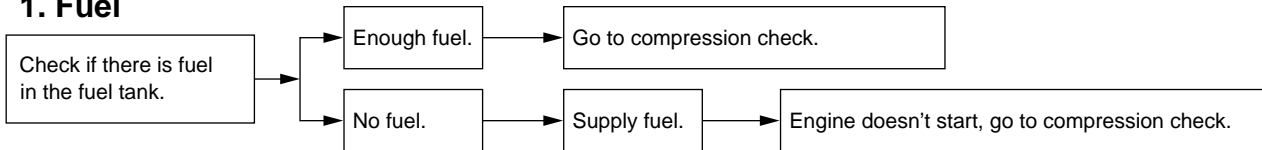

2. Compression

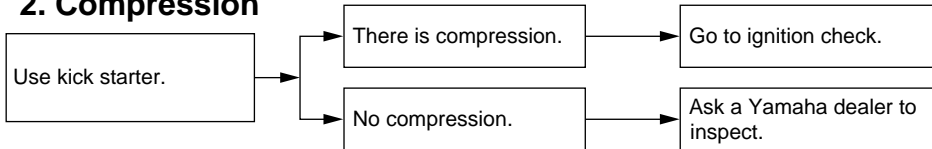

3. Ignition

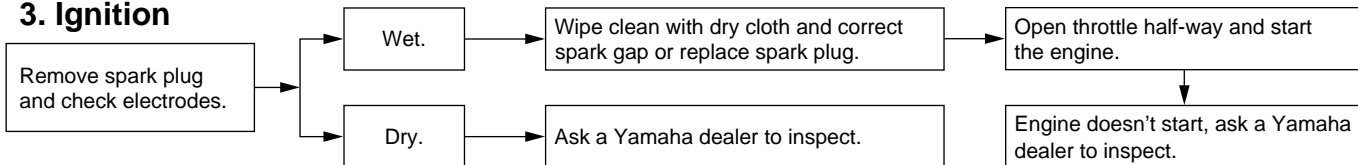

PERIODIC MAINTENANCE AND MINOR REPAIR

4. Engine overheating

EW000070

⚠WARNING

Do not remove the radiator cap when the engine and radiator are hot. Scalding hot fluid and steam may be blown out under pressure, which could cause serious injury. Open the radiator cap as follows. Wait until the engine has cooled. Remove the radiator cap stopper by removing the screw. Place a thick rag like a towel over the radiator cap and slowly rotate the cap counterclockwise to the detent. This procedure allows any residual pressure to escape. When the hissing sound has stopped, press down on the cap while turning counterclockwise and remove it.

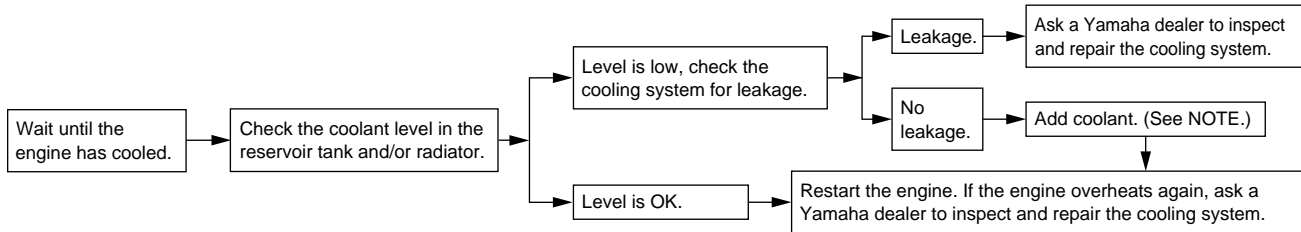

NOTE:

If it is difficult to get the recommended coolant, tap water can be temporarily used, provided that it is changed to the recommended coolant as soon as possible.

MOTORCYCLE CARE AND STORAGE

Care

The exposure of its technology makes a motorcycle charming but also vulnerable. Although high-quality components are used, they are not all rust-resistant. While a rusty exhaust pipe may remain unnoticed on a car, it does look unattractive on a motorcycle. Frequent and proper care, however, will keep your motorcycle looking good, extend its life and maintain its performance. Moreover, the warranty states that the vehicle must be properly taken care of. For all these reasons, it is recommended that you observe the following cleaning and storing precautions.

Before cleaning

1. Cover up the muffler outlet with a plastic bag.
2. Make sure that all caps and covers as well as all electrical couplers and connectors, including the spark plug cap, are tightly installed.
3. Remove extremely stubborn dirt, like oil burnt onto the crankcase, with a degreasing agent and a brush, but never apply such products onto seals, gaskets, sprockets, the drive chain and wheel axles. Always rinse the dirt and degreaser off with water.

Cleaning

After normal use

Remove dirt with warm water, a neutral detergent and a soft clean sponge, then rinse with plenty of clean water. Use a tooth or bottle brush for hard-to-reach parts. Tougher dirt and insects will come off more easily if the area is covered with a wet cloth for a few minutes before cleaning.

ECA00010

CAUTION: _____

- **Avoid using strong acidic wheel cleaners, especially on spoked wheels. If you do use such products for hard-to-remove dirt, do not leave it on any longer than instructed, then thoroughly rinse it off with water, immediately dry the area and apply a corrosion protection spray.**

MOTORCYCLE CARE AND STORAGE

- Improper cleaning can damage windshields, cowlings, panels and other plastic parts. Use only a soft, clean cloth or sponge with mild detergent and water to clean plastic.
 - Do not use any harsh chemical products on plastic parts. Be sure to avoid using cloths or sponges which have been in contact with strong or abrasive cleaning products, solvent or thinner, fuel (gasoline), rust removers or inhibitors, brake fluid, antifreeze or electrolyte.
 - Do not use high-pressure washers or steam-jet cleaners since they cause water seepage and deterioration in the following areas: seals (of wheel bearings, swingarm bearings, forks and brakes), electric components (couplers, connectors, instruments, switches and lights), breather hoses and vents.
 - For motorcycles equipped with a windshield: Do not use strong cleaners or hard sponges as they will cause dulling or scratching. Some cleaning compounds for plastic may leave scratches on the windshield. Test the product on a small hidden part of the windshield to make sure they do not leave any marks. If the windshield is scratched, use a quality plastic polishing compound after washing.
-

After riding in the rain, near the sea or on salt-sprayed roads

Since sea salt or salt sprayed on the roads in the winter are extremely corrosive in combination with water, carry out the following steps after each ride in the rain, near the sea or on salt-sprayed roads. (Salt sprayed in the winter may remain on the roads well into spring.)

1. Clean your motorcycle with cold water and soap after the engine has cooled down.

ECA00012

CAUTION: _____

Do not use warm water since it increases the corrosive action of the salt.

2. Be sure to apply a corrosion protection spray on all (even chrome- and nickel-plated) metal surfaces to prevent corrosion.

MOTORCYCLE CARE AND STORAGE

After cleaning

1. Dry the motorcycle with a chamois or an absorbing cloth.
2. Immediately dry the drive chain and lubricate it to prevent it from rusting.
3. Use a chrome polish to shine chrome, aluminum and stainless-steel parts, including the exhaust system. (Even the thermally induced discoloring of stainless-steel exhaust systems can be removed through polishing.)
4. To prevent corrosion, it is recommended to apply a corrosion protection spray on all (even chrome- and nickel-plated) metal surfaces.
5. Use spray oil as a universal cleaner to remove any remaining dirt.
6. Touch up minor paint damage caused by stones, etc.
7. Wax all painted surfaces.
8. Let the motorcycle dry completely before storing it or covering it.

EWA00001

⚠ WARNING

Make sure that there is no oil or wax on the brakes and tires. If necessary, clean the brake discs and linings with a regular brake disc cleaner or acetone, and wash the tires with warm water and mild soap. Then, carefully test the motorcycle for its braking performance and cornering behavior.

ECA00013

CAUTION:

- **Apply spray oil and wax sparingly and wipe off any excess.**
 - **Never apply oil or wax on rubber and plastic parts, but treat them with a suitable care product.**
 - **Avoid using abrasive polishing compounds as they wear away the paint.**
-

NOTE: _____
Consult a Yamaha dealer for advice on what products to use.

Storage

Short-term

Always store your motorcycle in a cool, dry place and, if necessary, protect it against dust with a porous cover.

ECA00014

CAUTION:

- **Storing the motorcycle in a poorly ventilated room or covering it with a tarp while it is still wet will allow water and humidity to seep in and cause rust.**
 - **To prevent corrosion, avoid damp cellars, stables (because of the presence of ammonia) and areas where strong chemicals are stored.**
-

Long-term

Before storing your motorcycle for several months:

1. Follow all the instructions in the “Care” section of this chapter.
2. Drain the carburetor float chamber by loosening the drain bolt; this will prevent fuel deposits from building up. Pour the drained fuel into the fuel tank.
3. Only for motorcycles equipped with a fuel cock which has an “OFF” position: Turn the fuel cock to “OFF”.
4. Fill up the fuel tank and add fuel stabilizer (if available) to prevent the fuel tank from rusting and the fuel from deteriorating.
5. Perform the following steps to protect the cylinder, piston rings, etc. from corrosion.

- a. Remove the spark plug cap and spark plug.
- b. Pour a teaspoonful of engine oil into the spark plug bore.
- c. Install the spark plug cap onto the spark plug and place the spark plug on the cylinder head so that the electrodes are grounded. (This will limit sparking during the next step.)
- d. Turn the engine over several times with the starter. (This will coat the cylinder wall with oil.)
- e. Remove the spark plug cap from the spark plug, install the spark plug and then the spark plug cap.

EWA00003

WARNING

When turning the engine over, be sure to ground the spark plug electrodes to prevent damage or injury from sparking.

MOTORCYCLE CARE AND STORAGE

6. Lubricate all control cables and the pivoting points of all levers and pedals as well as of the sidestand/centerstand.
7. Check and, if necessary, correct the tire air pressure, then raise the motorcycle so that both of its wheels are off the ground. Alternatively, turn the wheels a little every month in order to prevent the tires from becoming degraded in one spot.
8. Cover up the muffler outlet with a plastic bag to prevent moisture from entering.
9. Remove the battery and fully charge it. Store it in a cool, dry place and recharge it once a month. Do not store the battery in an excessively cold or warm place (less than 0 °C or more than 30 °C). For more information, see “Battery storage” in the chapter “PERIODIC MAINTENANCE AND MINOR REPAIRS”.

NOTE: _____

Make any necessary repairs before storing the motorcycle.

Specifications

Model	DT125R	Compression ratio	6.7:1
Dimensions		Starting system	Kick starter
Overall length	2,170 mm 2,235 mm (N, S, SF, CH, A only)	Lubrication system	Separate lubrication (Yamaha autolube)
Overall width	830 mm	Engine oil (2-cycle)	
Overall height	1,255 mm	Type	2 stroke engine oil
Seat height	885 mm	Capacity	
Wheel base	1,415 mm	Total amount	1.2 L
Ground clearance	315 mm	Transmission oil	
Minimum turning radius	2,100 mm	Type	SAE 10W/30 type SE motor oil
Basic weight (with oil and full fuel tank)	127 kg 129 kg (CH, A only)	Capacity	
Engine		Periodic oil change	0.75 L
Engine type	Liquid-cooled 2-stroke	Total amount	0.8 L
Cylinder arrangement	Forward-inclined single cylinder	Radiator capacity	
Displacement	124 cm ³	(Including all routes)	0.92 L
Bore × Stroke	56.0 × 50.7 mm	Air filter	Wet type element
		Fuel	
		Type	Regular unleaded gasoline
		Fuel tank capacity	10 L
		Reserve amount	1.8 L

SPECIFICATIONS

Carburetor

Type × quantity	TM28SS × 1
Manufacturer	MIKUNI

Spark plug

Manufacturer / type	NGK / BR9ES NGK / BR8ES (CH, A only)
---------------------	-----------------------------------------

Spark plug gap	0.7 ~ 0.8 mm
----------------	--------------

Clutch type

Wet, multiple-disc

Transmission

Primary reduction system	Helical gear
Primary reduction ratio	71/22 (3.227)
Secondary reduction system	Chain drive
Secondary reduction ratio	57/16 (3.563)
Transmission type	Constant mesh 6-speed
Operation	Left foot operation
Gear ratio	1st 2.833 2nd 1.875 3rd 1.412 4th 1.143 5th 0.957 6th 0.818

Chassis

Frame type	Semi double cradle
Caster angle	27°30'
Trail	113 mm

Tire

Type	With tube
Front	
Size	2.75-21 45P
Manufacturer/ model	BRIDGESTONE / TW25

Rear	
Size	4.10-18 59P
Manufacturer/ model	BRIDGESTONE / TW44

Maximum load*	180 kg 178 kg (CH, A only)
---------------	-------------------------------

Air pressure (cold tire) up to 90 kg load*	
Front	125 kPa (1.25 kg/cm ² , 1.25 bar)
Rear	150 kPa (1.50 kg/cm ² , 1.50 bar)

90 kg load ~ maximum load*

Front 150 kPa (1.50 kg/cm², 1.50 bar)

Rear 175 kPa (1.75 kg/cm², 1.75 bar)

Off-road riding

Front 125 kPa (1.25 kg/cm², 1.25 bar)

Rear 150 kPa (1.50 kg/cm², 1.50 bar)

* Load is total weight of cargo, rider, passenger and accessories.

Wheels

Front

Type Spoke wheel

Size 1.60 × 21

Rear

Type Spoke wheel

Size 1.85 × 18

Brakes

Front

Type Single disc brake

Operation Right hand operation

Fluid DOT 3 or DOT 4

Rear

Type Single disc brake

Operation Right foot operation

Fluid DOT 3 or DOT 4

Suspension

Front Telescopic fork

Rear Swingarm (link suspension)

Shock absorber

Front Coil spring/oil damper

Rear Coil-gas spring/oil damper

Wheel travel

Front 270 mm

Rear 260 mm

Electrical

Ignition system C.D.I.

Charging system
Type C.D.I. magneto

SPECIFICATIONS

Battery

Type	GM3-3B
Voltage, capacity	12 V, 3 AH

Headlight type Conventional incandescent bulb

Bulb voltage, wattage × quantity

Headlight	12 V, 45/40 W × 1
Tail / Brake light	12 V, 5/21 W × 1
Front flasher light	12 V, 21 W × 2
Rear flasher light	12 V, 21 W × 2
Auxiliary light	12 V, 4 W × 1
	12 V, 3.4 W × 1 (GB only)
Meter light	12 V, 3.4 W × 2
Neutral indicator light	12 V, 3.4 W × 1
High beam indicator light	12 V, 3.4 W × 1
Oil level indicator light	12 V, 3.4 W × 1
Turn indicator light	12 V, 3.4 W × 1

Fuse

Main	10 A
------	------

EAU01064

HOW TO USE THE CONVERSION TABLE

All specification data in this manual are listed in SI and METRIC UNITS.

Use this table to convert METRIC unit data to IMPERIAL unit data.

Ex.

METRIC		MULTIPLIER	=	IMPERIAL
** mm	×	0.03937	=	** in
2 mm	×	0.03937	=	0.08 in

CONVERSION TABLE

METRIC TO IMPERIAL			
	Metric unit	Multiplier	Imperial unit
Torque	m • kg	7.233	ft • lb
	m • kg	86.794	in • lb
	cm • kg	0.0723	ft • lb
	cm • kg	0.8679	in • lb
Weight	kg	2.205	lb
	g	0.03527	oz
Speed	km/hr	0.6214	mph
Distance	km	0.6214	mi
	m	3.281	ft
	m	1.094	yd
	cm	0.3937	in
	mm	0.03937	in
Volume/ Capacity	cc (cm3)	0.03527	oz (IMP liq.)
	cc (cm3)	0.06102	cu • in
	lt (liter)	0.8799	qt (IMP liq.)
	lt (liter)	0.2199	gal (IMP liq.)
Misc.	kg/mm	55.997	lb/in
	kg/cm2	14.2234	psi (lb/in2)
	Centigrade(°C)	9/5 + 32	Fahrenheit(°F)

CONSUMER INFORMATION

EAU02944

Identification number records

Record the key identification number, vehicle identification number and model label information in the spaces provided for assistance when ordering spare parts from a Yamaha dealer or for reference in case the vehicle is stolen.

1. KEY IDENTIFICATION NUMBER:

2. VEHICLE IDENTIFICATION NUMBER:

3. MODEL LABEL INFORMATION:

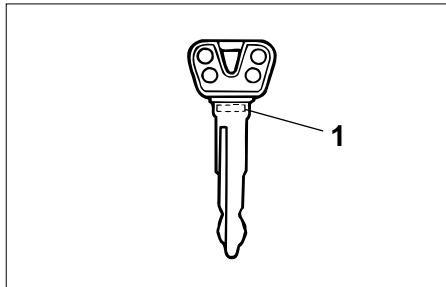

1. Key identification number

EAU01042

Key identification number

The key identification number is stamped on the key. Record this number in the space provided and use it for reference when obtaining a new key.

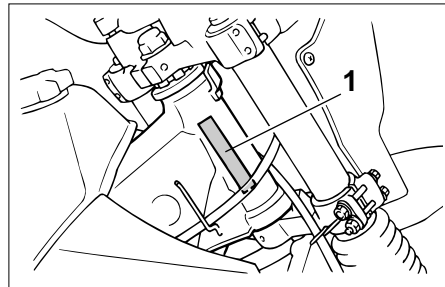

1. Vehicle identification number

EAU01043

Vehicle identification number

The vehicle identification number is stamped into the steering head pipe. Record this number in the space provided.

NOTE: _____

The vehicle identification number is used to identify your motorcycle and may be used to register your motorcycle with the licensing authority in your state.

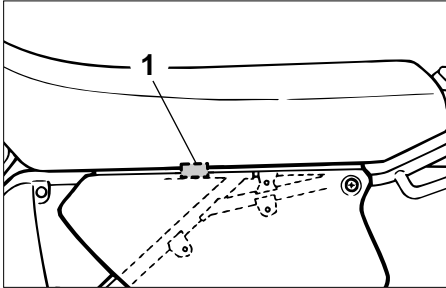

1. Model label

EAU01049

Model label

The model label is affixed to the location shown in the figure. Record the information on this label in the space provided. This information will be needed to order spare parts from your Yamaha dealer.



PRINTED ON RECYCLED PAPER

PRINTED IN JAPAN
2000.12-0.4x1(E) 