



OWNER'S MANUAL

*Virago*

**XV125S**

5AJ-28199-E3



Welcome to the Yamaha world of motorcycling!

As the owner of a XV125S, you are benefiting from Yamaha's vast experience in and newest technology for the design and the manufacture of high-quality products, which have earned Yamaha a reputation for dependability.

Please take the time to read this manual thoroughly, so as to enjoy all your XV125S's advantages. The owner's manual does not only instruct you in how to operate, inspect and maintain your motorcycle, but also in how to safeguard yourself and others from trouble and injury.

In addition, the many tips given in this manual will help to keep your motorcycle in the best possible condition. If you have any further questions, do not hesitate to contact your Yamaha dealer.

The Yamaha team wishes you many safe and pleasant rides. So, remember to put safety first!

# IMPORTANT MANUAL INFORMATION

---

EAU00005

Particularly important information is distinguished in this manual by the following notations:



**The Safety Alert Symbol means ATTENTION! BECOME ALERT! YOUR SAFETY IS INVOLVED!**



**Failure to follow WARNING instructions could result in severe injury or death to the motorcycle operator, a bystander or a person inspecting or repairing the motorcycle.**

**CAUTION:**

**A CAUTION indicates special precautions that must be taken to avoid damage to the motorcycle.**

**NOTE:**

A NOTE provides key information to make procedures easier or clearer.

**NOTE:** \_\_\_\_\_

- This manual should be considered a permanent part of this motorcycle and should remain with it even if the motorcycle is subsequently sold.
  - Yamaha continually seeks advancements in product design and quality. Therefore, while this manual contains the most current product information available at the time of printing, there may be minor discrepancies between your motorcycle and this manual. If there is any question concerning this manual, please consult your Yamaha dealer.
-

# IMPORTANT MANUAL INFORMATION

---

---

EW000002

## **⚠ WARNING**

---

**PLEASE READ THIS MANUAL CAREFULLY AND COMPLETELY BEFORE OPERATING THIS MOTORCYCLE.**

---

---

---

EAU00008

**XV125S**

**OWNER'S MANUAL**

**©1999 by Yamaha Motor Co., Ltd.**

**1st Edition, June 1999**

**All rights reserved. Any reprinting or  
unauthorized use without the written  
permission of Yamaha Motor Co., Ltd.  
is expressly prohibited.**

**Printed in Japan.**

<b>1</b>	GIVE SAFETY THE RIGHT OF WAY .....	1-1			Sidestand/clutch switch operation check.....	3-11
<b>2</b>	DESCRIPTION .....	2-1	<b>4</b>	PRE-OPERATION CHECKS.....	4-1	
	Left view.....	2-1		Pre-operation check list .....	4-1	
	Right view .....	2-2	<b>5</b>	OPERATION AND IMPORTANT RIDING		
	Controls/Instruments .....	2-3		POINTS.....	5-1	
<b>3</b>	INSTRUMENT AND CONTROL			Starting the engine .....	5-1	
	FUNCTIONS.....	3-1		Starting a warm engine .....	5-3	
	Main switch .....	3-1		Shifting.....	5-4	
	Indicator lights.....	3-1		Recommended shift point		
	Speedometer .....	3-2		(for Switzerland only) .....	5-4	
	Handlebar switches.....	3-2		Tips for reducing fuel consumption .....	5-5	
	Clutch lever.....	3-4		Engine break-in .....	5-5	
	Shift pedal.....	3-4		Parking .....	5-6	
	Front brake lever .....	3-4	<b>6</b>	PERIODIC MAINTENANCE AND MINOR		
	Rear brake pedal .....	3-5		REPAIR .....	6-1	
	Fuel tank cap.....	3-5		Tool kit .....	6-1	
	Fuel.....	3-6		Periodic maintenance and lubrication.....	6-3	
	Fuel cock .....	3-7		Panel removal and installation .....	6-6	
	Starter (choke) “ ” .....	3-8		Panel A .....	6-6	
	Steering lock.....	3-8		Panel B .....	6-7	
	Seat .....	3-9		Spark plugs.....	6-8	
	Helmet holder.....	3-9		Engine oil.....	6-9	
	Rear shock absorber adjustment.....	3-10		Air filter .....	6-12	
	Sidestand .....	3-10				

# TABLE OF CONTENTS

---

Carburetor adjustment .....	6-15
Idle speed adjustment .....	6-15
Throttle cable free play adjustment.....	6-16
Valve clearance adjustment .....	6-16
Tires.....	6-17
Wheels .....	6-19
Clutch lever free play adjustment.....	6-19
Front brake lever free play adjustment .....	6-20
Rear brake pedal height and free play adjustment.....	6-21
Brake light switch adjustment.....	6-22
Checking the front brake pads and rear brake shoes .....	6-22
Inspecting the brake fluid level .....	6-23
Brake fluid replacement.....	6-24
Drive chain slack check.....	6-24
Drive chain slack adjustment .....	6-25
Drive chain lubrication.....	6-26
Cable inspection and lubrication .....	6-27
Throttle cable and grip lubrication .....	6-27
Brake and shift pedal lubrication .....	6-28
Brake and clutch lever lubrication .....	6-28
Sidestand lubrication.....	6-28
Front fork inspection.....	6-29
Steering inspection .....	6-29
Wheel bearings .....	6-30

Battery.....	6-30
Fuse replacement.....	6-32
Headlight bulb replacement.....	6-33
Turn signal light bulb replacement .....	6-34
Taillight bulb replacement .....	6-35
Supporting the motorcycle .....	6-36
Front wheel removal.....	6-36
Front wheel installation .....	6-37
Rear wheel removal.....	6-38
Rear wheel installation .....	6-39
Troubleshooting.....	6-40
Troubleshooting chart .....	6-41

## 7

MOTORCYCLE CARE AND STORAGE .....	7-1
Care .....	7-1
Storage.....	7-4

## 8

SPECIFICATIONS.....	8-1
How to use the conversion table .....	8-5

## 9

CONSUMER INFORMATION .....	9-1
Identification number records.....	9-1
Key identification number .....	9-1
Vehicle identification number .....	9-1
Model label.....	9-2







# GIVE SAFETY THE RIGHT OF WAY

---

Motorcycles are fascinating vehicles, which can give you an unsurpassed feeling of power and freedom. However, they also impose certain limits, which you must accept; even the best motorcycle does not ignore the laws of physics.

Regular care and maintenance are essential for preserving your motorcycle's value and operating condition. Moreover, what is true for the motorcycle is also true for the rider: good performance depends on being in good shape. Riding under the influence of medication, drugs and alcohol is, of course, out of the question. Motorcycle riders - more than car drivers - must always be at their mental and physical best. Under the influence of even small amounts of alcohol, there is a tendency to take dangerous risks.

Protective clothing is as essential for the motorcycle rider as seat belts are for car drivers and passengers. Always wear a complete motorcycle suit (whether made of leather or tear-resistant synthetic materials with protectors), sturdy boots, motorcycle gloves and a properly fitting helmet. Optimum protective wear, however, should not encourage carelessness. Though full-coverage helmets and suits, in particular, create an illusion of total safety and protection, motorcyclists will always be vulnerable. Riders who lack critical self-control run the risk of going too fast and are apt to take chances. This is even more dangerous in wet weather. The good motorcyclist rides safely, predictably and defensively - avoiding all dangers, including those caused by others.

Enjoy your ride!



# DESCRIPTION

## Left view

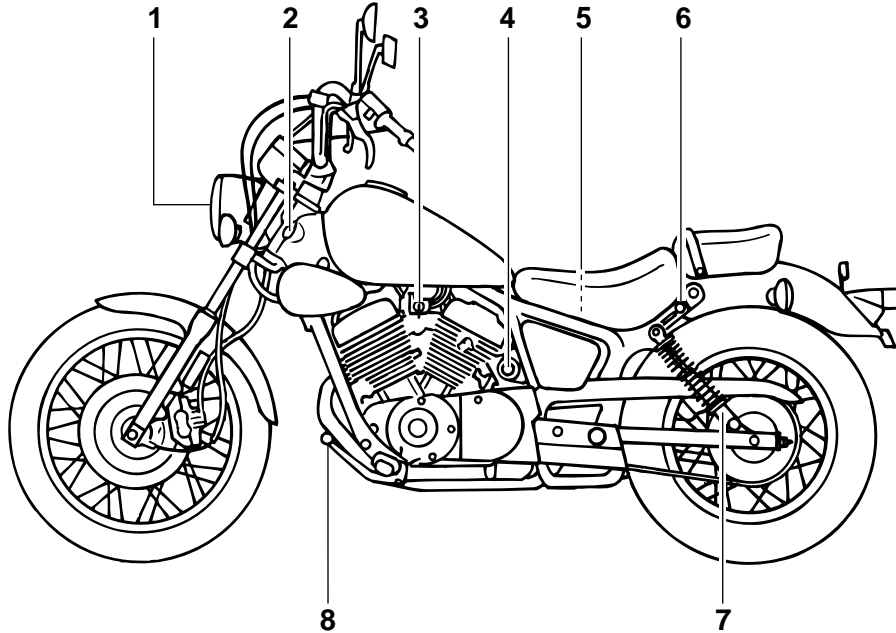

- |                  |             |   |             |
|------------------|-------------|---|-------------|
| 1. Headlight     | (page 6-33) | 6. Helmet holder  | (page 3-9)  |
| 2. Steering lock | (page 3-8)  | 7. Rear shock absorber spring preload<br>adjusting ring | (page 3-10) |
| 3. Fuel cock     | (page 3-7)  | 8. Shift pedal  | (page 3-4)  |
| 4. Main switch   | (page 3-1)  |   |             |
| 5. Fuses         | (page 6-32) |   |             |

**Right view**

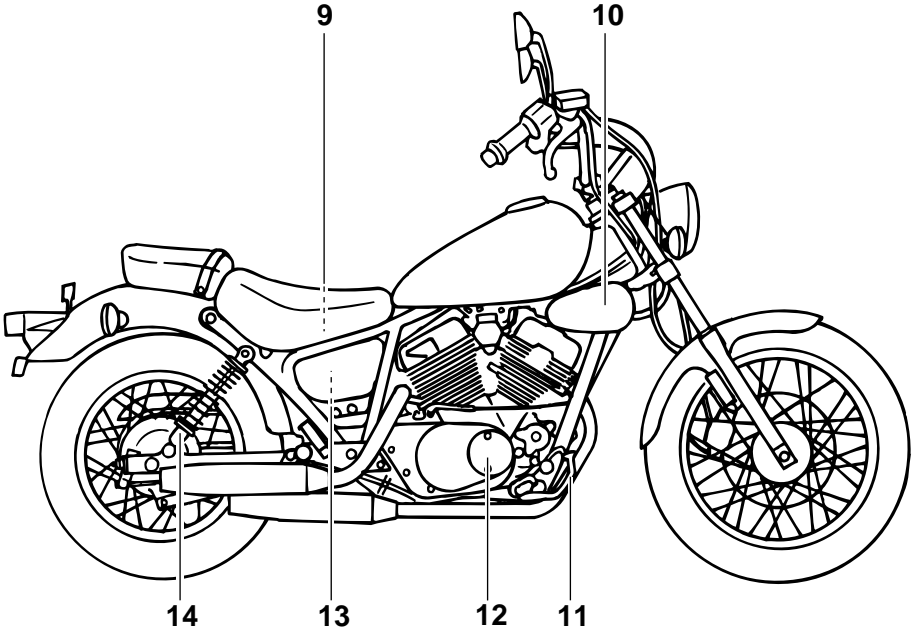

- 9. Battery (page 6-30)
- 10. Air filter (page 6-12)
- 11. Rear brake pedal (page 3-5, 6-21)
- 12. Oil filter (page 6-9)
- 13. Tool kit (page 6-1)

- 14. Rear shock absorber spring preload adjusting ring (page 3-10)

# DESCRIPTION

---

## Controls/Instruments

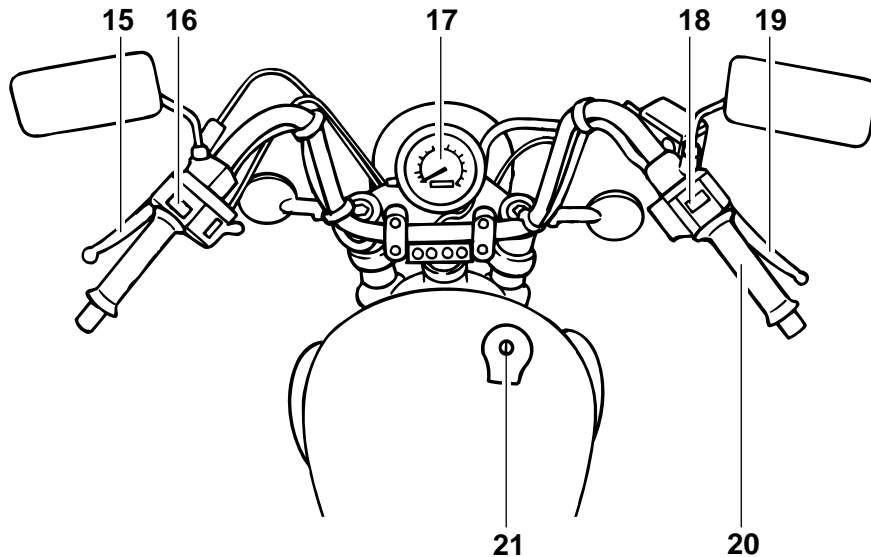

- 15. Clutch lever (page 3-4, 6-19)
- 16. Left handlebar switches (page 3-2)
- 17. Speedometer (page 3-2)
- 18. Right handlebar switches (page 3-3)
- 19. Front brake lever (page 3-4, 6-20)

- 20. Throttle grip (page 6-16)
- 21. Fuel tank cap (page 3-5)

# INSTRUMENT AND CONTROL FUNCTIONS

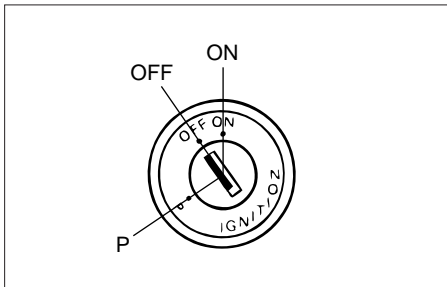

## Main switch

EAU00028

The main switch controls the ignition and lighting systems. Its operation is described below.

## ON

EAU00036

Electrical circuits are switched on. The engine can be started. The key cannot be removed in this position.

## OFF

EAU00038

All electrical circuits are switched off. The key can be removed in this position.

EAU00054

## P (Parking)

The taillight and auxiliary light come on but all other circuits are off. With the key at "OFF", push it into the main switch, turn it counterclockwise to "P", and remove it. To cancel the parking, turn the key clockwise.

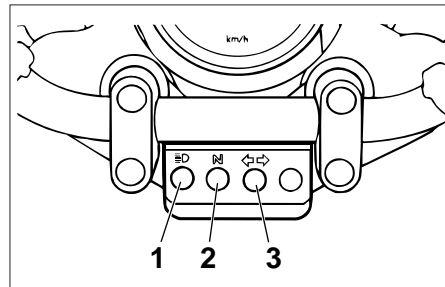

1. High beam indicator light "≡D"
2. Neutral indicator light "N"
3. Turn indicator light "↔"

## Indicator lights

EAU00056

### High beam indicator light "≡D"

EAU00063

This indicator comes on when the headlight high beam is used.

### Neutral indicator light "N"

EAU00061

This indicator comes on when the transmission is in neutral.

### Turn indicator light "↔"

EAU00057

This indicator flashes when the turn switch is moved to the left or right.

# INSTRUMENT AND CONTROL FUNCTIONS

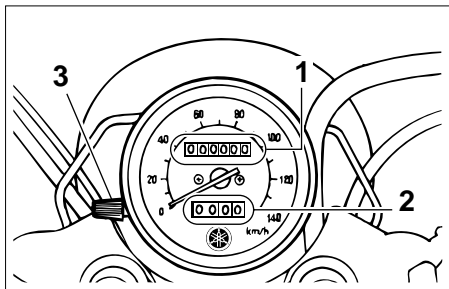

1. Odometer
2. Trip odometer
3. Reset knob

EAU01087

## Speedometer

The speedometer shows riding speed. This speedometer is equipped with an odometer and trip odometer. The trip odometer can be reset to "0" with the reset knob. Use the trip odometer to estimate how far you can ride on a tank of fuel. This information will enable you to plan fuel stops in the future.

**NOTE:** \_\_\_\_\_  
(for German model equipped with speed limiter only)  
This motorcycle is equipped with a speed limiter which prevents it from exceeding a top speed of 80 km/h.  
\_\_\_\_\_

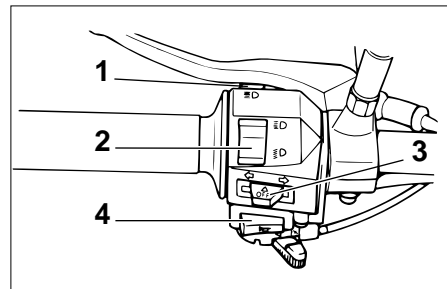

1. Pass switch "≡D"
2. Dimmer switch
3. Turn signal switch
4. Horn switch "D"

EAU00118

## Handlebar switches

EAU00119

### Pass switch "≡D"

Press the switch to operate the passing light.

EAU00121

### Dimmer switch

Turn the switch to "≡D" for the high beam and to "≡D" for the low beam.



# INSTRUMENT AND CONTROL FUNCTIONS

## Turn signal switch

EAU00127

To signal a right-hand turn, push the switch to "⇒". To signal a left-hand turn, push the switch to "⇐". Once the switch is released it will return to the center position. To cancel the signal, push the switch in after it has returned to the center position.

## Horn switch "📢"

EAU00129

Press the switch to sound the horn.

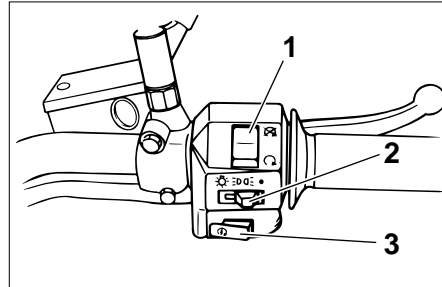

1. Engine stop switch
2. Lights switch
3. Start switch "⊗"

## Lights switch

EAU00134

Turning the light switch to "⇒▷◁⇐", turns on the auxiliary light, meter lights and taillight. Turning the light switch to "☀" turns the headlight on also.

## Engine stop switch

EAU00138

The engine stop switch is a safety device for use in an emergency such as when the motorcycle over-turns or if trouble occurs in the throttle system. Turn the switch to "⊙" to start the engine. In case of emergency, turn the switch to "⊗" to stop the engine.

## Start switch "⊗"

EAU00143

The starter motor cranks the engine when pushing the start switch.

## CAUTION:

**See starting instructions prior to starting the engine.**

# INSTRUMENT AND CONTROL FUNCTIONS

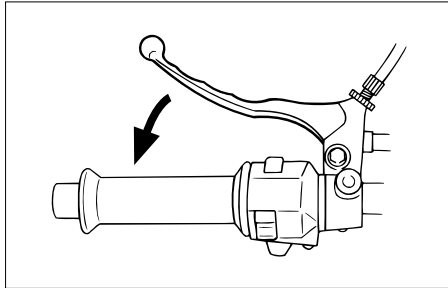

EAU00152

## Clutch lever

The clutch lever is located on the left handlebar, and the ignition circuit cut-off system is incorporated in the clutch lever holder. Pull the clutch lever to the handlebar to disengage the clutch, and release the lever to engage the clutch. The lever should be pulled rapidly and released slowly for smooth clutch operation. (Refer to the engine starting procedures for a description of the ignition circuit cut-off system.)

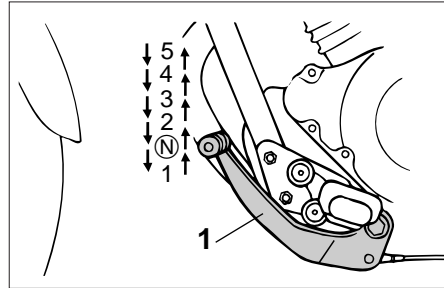

N. Neutral  
1. Shift pedal

## Shift pedal

This motorcycle is equipped with a constant-mesh 5-speed transmission.

The shift pedal is located on the left side of the engine and is used in combination with the clutch when shifting.

EAU00157

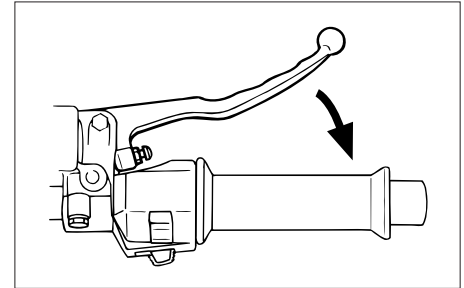

EAU00158

## Front brake lever

The front brake lever is located on the right handlebar. Pull it toward the handlebar to apply the front brake.

# INSTRUMENT AND CONTROL FUNCTIONS

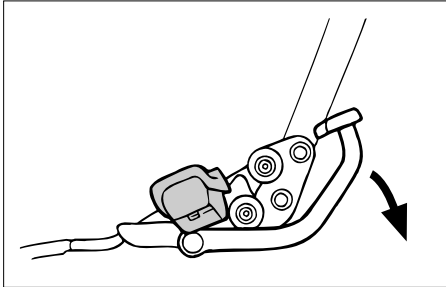

EAU00162

## Rear brake pedal

The rear brake pedal is on the right side of the motorcycle. Press down on the brake pedal to apply the rear brake.

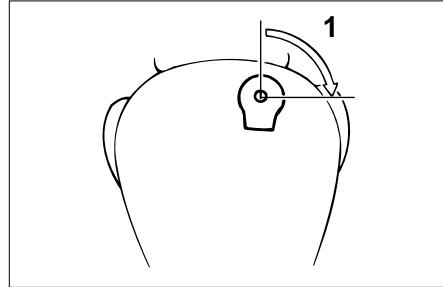

1. Open

EAU00167

## Fuel tank cap

### To open

Insert the key and turn it 1/4 turn clockwise. The lock will be released and the cap can be opened.

### To close

Push the tank cap into position with the key inserted. To remove the key, turn it counterclockwise to the original position.

**NOTE:** \_\_\_\_\_

This tank cap cannot be closed unless the key is in the lock. The key cannot be removed if the cap is not locked properly.

**WARNING** \_\_\_\_\_

EW000023

**Be sure the cap is properly installed and locked in place before riding the motorcycle.**

# INSTRUMENT AND CONTROL FUNCTIONS

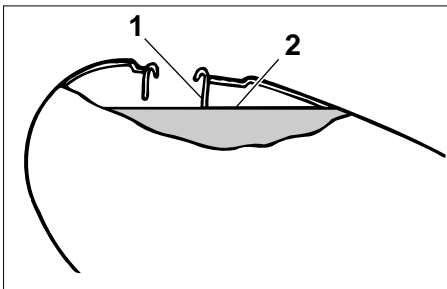

1. Filler tube
2. Fuel level

EAU001183

## Fuel

Make sure there is sufficient fuel in the tank. Fill the fuel tank to the bottom of the filler tube as shown in the illustration.

EW000130

## **⚠WARNING**

**Do not overfill the fuel tank. Avoid spilling fuel on the hot engine. Do not fill the fuel tank above the bottom of the filler tube or it may overflow when the fuel heats up later and expands.**

EAU00185

## **CAUTION:**

**Always wipe off spilled fuel immediately with a dry and clean soft cloth. Fuel may deteriorate painted surfaces or plastic parts.**

EAU00191

Recommended fuel:

Regular unleaded gasoline with a research octane number of 91 or higher.

Fuel tank capacity:

Total:

9.5 L

Reserve:

2.6 L

## **NOTE:**

If knocking or pinging occurs, use a different brand of gasoline or higher octane grade.

# INSTRUMENT AND CONTROL FUNCTIONS

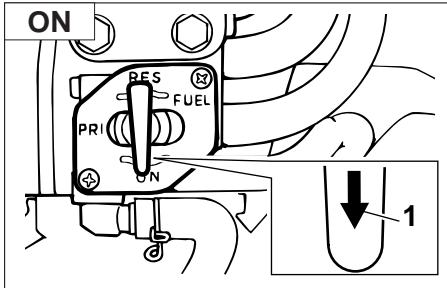

1. Arrow mark pointing to "ON"

EAU00208

## Fuel cock

The negative pressure fuel cock supplies fuel from the tank to the carburetor while filtering it also.

The fuel cock has the following three positions:

### ON

With the lever in this position, fuel flows if the engine is running, but stops if the engine is not running.

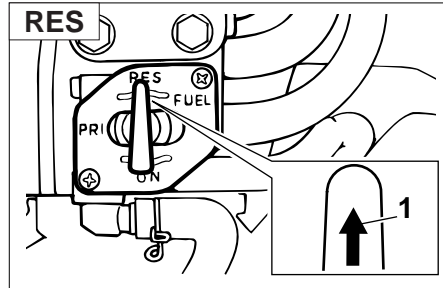

1. Arrow mark pointing to "RES"

### RES

This indicates reserve. If you run out of fuel while riding, move the lever to "PRI", start the engine, then move the lever to "RES". FILL THE TANK AT THE FIRST OPPORTUNITY. BE SURE TO MOVE THE LEVER TO "ON" AFTER REFUELING.

### NOTE:

The fuel cock operates on vacuum from the engine when set at "ON" or "RES". If the line connecting the cock to the carburetor intake manifold is not connected or has a leak, the cock will not function properly.

# INSTRUMENT AND CONTROL FUNCTIONS

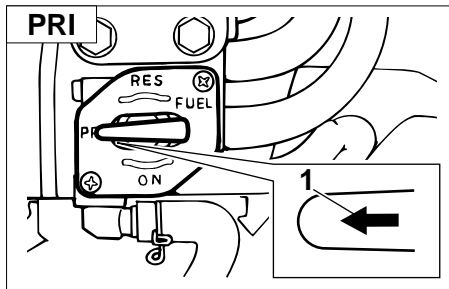

1. Arrow mark pointing to “PRI”

## PRI

This indicates prime. With the lever in this position, fuel flows whether the engine is running or not. If the fuel tank is completely empty, refill the tank and move the lever to “PRI” to prime the carburetor. Move the lever to “ON” after starting the engine.

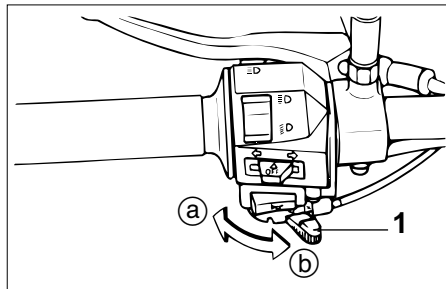

1. Starter (choke) “|”

## Starter (choke) “|”

EAU02976

Starting a cold engine requires a richer air-fuel mixture. A separate starter circuit supplies this mixture. Move in direction **a** to turn on the starter (choke). Move in direction **b** to turn off the starter (choke).

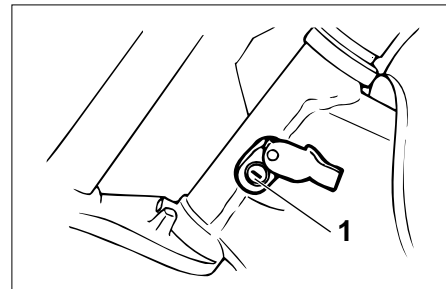

1. Steering lock

## Steering lock

EAU02934

### To lock the steering

Turn the handlebars all the way to the right and open the steering lock cover.

Insert the key and turn it 1/8 turn counterclockwise. Then, push the key in while turning the handlebars slightly to the left and turn the key 1/8 turn clockwise.

Check that the steering is locked, remove the key and close the lock cover.

### To unlock the steering

Insert the key, push it in and turn it 1/8 turn counterclockwise so that it moves out. Then, release and remove the key.

# INSTRUMENT AND CONTROL FUNCTIONS

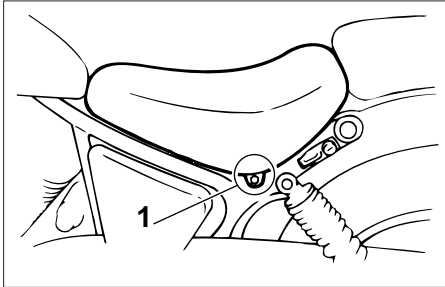

1. Bolt (x2)

EAU03020

## Seat

### To remove

1. Remove panels A and B. (See page 6-6 for panel removal and installation procedures.)
2. Remove the rider seat bolts and lift the seat upward.

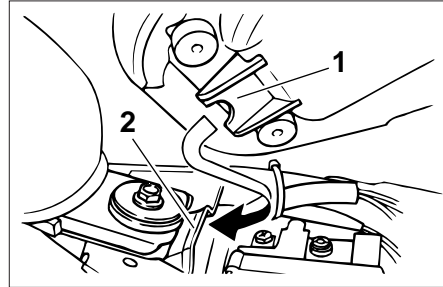

1. Projection
2. Seat holder

### To install

1. Insert the projection on the front of the rider seat into the seat holder, then tighten the seat bolts.
2. Install the panels.

**NOTE:** \_\_\_\_\_  
Make sure that the seat is securely fitted.  
\_\_\_\_\_

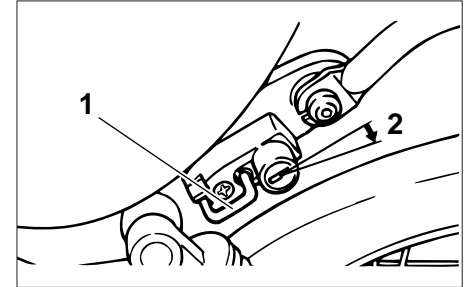

1. Helmet holder
2. Open

EAU00260

## Helmet holder

To open the helmet holder, insert the key in the lock and turn it as shown. To lock the helmet holder, replace the holder in its original position.

EW000030

### **WARNING**

**Never ride with a helmet in the helmet holder. The helmet may hit objects, causing loss of control and possibly an accident.**

# INSTRUMENT AND CONTROL FUNCTIONS

EAU00330

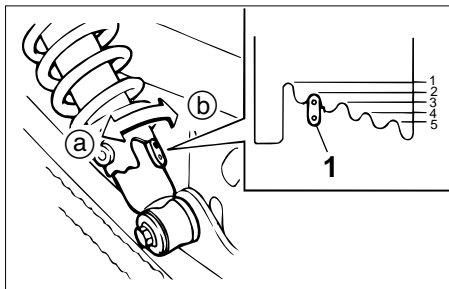

1. Position indicator

EAU00300

## Rear shock absorber adjustment

Each shock absorber is equipped with a spring preload adjusting ring. Adjust spring preload as follows.

Turn the adjusting ring in direction ① to increase spring preload and in direction ② to decrease spring preload. Make sure that the appropriate notch in the adjusting ring is aligned with the position indicator on the rear shock absorber.

	Soft	Standard	Hard		
Adjusting position	1	2	3	4	5

EW000040

### **⚠ WARNING**

**Always adjust each shock absorber to the same setting. Uneven adjustment can cause poor handling and loss of stability.**

## Sidestand

This model is equipped with an ignition circuit cut-off system. The motorcycle must not be ridden when the sidestand is down. The sidestand is located on the left side of the frame. (Refer to page 5-1 for an explanation of this system.)



# INSTRUMENT AND CONTROL FUNCTIONS

## **⚠ WARNING**

EW000044

This motorcycle must not be operated with the sidestand in the down position. If the stand is not properly retracted, it could contact the ground and distract the operator, resulting in a possible loss of control. Yamaha has designed into this motorcycle a lockout system to assist the operator in fulfilling the responsibility of retracting the sidestand. Please check carefully the operating instructions listed below and if there is any indication of a malfunction, return the motorcycle to a Yamaha dealer immediately for repair.

## **Sidestand/clutch switch operation check**

EAU00331

Check the operation of the sidestand switch and clutch switch against the information below.

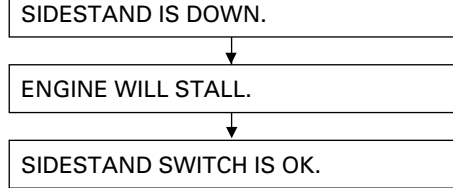
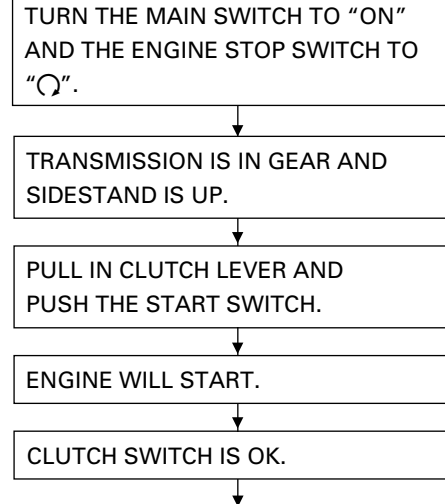

## **⚠ WARNING**

EW000045

If improper operation is noted, consult a Yamaha dealer immediately.

# PRE-OPERATION CHECKS

Owners are personally responsible for their vehicle's condition. Your motorcycle's vital functions can start to deteriorate quickly and unexpectedly, even if it remains unused (for instance, if it is exposed to the elements). Any damage, fluid leak or loss of tire pressure could have serious consequences. Therefore, it is very important that, in addition to a thorough visual inspection, you check the following points before each ride.

## PRE-OPERATION CHECK LIST

ITEM	CHECKS	PAGE
<b>Front brake</b>	<ul style="list-style-type: none"> <li>• Check operation, free play, fluid level and vehicle for fluid leakage.</li> <li>• Fill with DOT 4 (or DOT 3) brake fluid if necessary.</li> </ul>	3-4 ~ 3-5, 6-20 ~ 6-24
<b>Rear brake</b>	<ul style="list-style-type: none"> <li>• Check operation and free play.</li> <li>• Adjust if necessary.</li> </ul>	
<b>Clutch</b>	<ul style="list-style-type: none"> <li>• Check operation and free play.</li> <li>• Adjust if necessary.</li> </ul>	3-4, 6-19 ~ 6-20
<b>Throttle grip and housing</b>	<ul style="list-style-type: none"> <li>• Check for smooth operation.</li> <li>• Lubricate.</li> </ul>	6-16, 6-27
<b>Engine oil</b>	<ul style="list-style-type: none"> <li>• Check oil level.</li> <li>• Fill with oil if necessary.</li> </ul>	6-9 ~ 6-12
<b>Drive chain</b>	<ul style="list-style-type: none"> <li>• Check chain slack and condition.</li> <li>• Adjust if necessary.</li> </ul>	6-24 ~ 6-27
<b>Wheels and tires</b>	<ul style="list-style-type: none"> <li>• Check tire pressure, wear, damage and spoke tightness.</li> <li>• Tighten spokes if necessary.</li> </ul>	6-17 ~ 6-19
<b>Control and meter cable</b>	<ul style="list-style-type: none"> <li>• Check for smooth operation.</li> <li>• Lubricate if necessary.</li> </ul>	6-27
<b>Brake and shift pedal shafts</b>	<ul style="list-style-type: none"> <li>• Check for smooth operation.</li> <li>• Lubricate if necessary.</li> </ul>	6-28
<b>Brake and clutch lever pivots</b>	<ul style="list-style-type: none"> <li>• Check for smooth operation.</li> <li>• Lubricate if necessary.</li> </ul>	6-28

# PRE-OPERATION CHECKS

ITEM	CHECKS	PAGE
Sidestand pivot	<ul style="list-style-type: none"><li>• Check for smooth operation.</li><li>• Lubricate if necessary.</li></ul>	6-28
Chassis fasteners	<ul style="list-style-type: none"><li>• Make sure that all nuts, bolts, and screws are properly tightened.</li><li>• Tighten if necessary.</li></ul>	—
Fuel tank	<ul style="list-style-type: none"><li>• Check fuel level.</li><li>• Fill with fuel if necessary.</li></ul>	3-5 ~ 3-6
Lights, signals and switches	<ul style="list-style-type: none"><li>• Check for proper operation.</li></ul>	6-33 ~ 6-35
Battery	<ul style="list-style-type: none"><li>• Check fluid level.</li><li>• Fill with distilled water if necessary.</li></ul>	6-30 ~ 6-32

**NOTE:**

Pre-operation checks should be made each time the motorcycle is used. Such an inspection can be accomplished in a very short time; and the added safety it assures is more than worth the time involved.

**⚠WARNING**

If any item in the Pre-Operation Check is not working properly, have it inspected and repaired before operating the motorcycle.

# OPERATION AND IMPORTANT RIDING POINTS

---

## **⚠ WARNING**

EAU00373

- Before riding this motorcycle, become thoroughly familiar with all operating controls and their functions. Consult a Yamaha dealer regarding any control or function that you do not thoroughly understand.
- Never start your engine or let it run for any length of time in a closed area. The exhaust fumes are poisonous and can cause loss of consciousness and death within a short time. Always operate your motorcycle in an area with adequate ventilation.
- Before starting out, always be sure the sidestand is up. Failure to retract the sidestand completely can result in a serious accident when you try to turn a corner.

## Starting the engine

EAU00311

### NOTE:

This motorcycle is equipped with an ignition circuit cut-off system. The engine can be started only under one of the following conditions:

- The transmission is in neutral.
- The sidestand is up, the transmission is in gear and the clutch is disengaged.

The motorcycle must not be ridden when the sidestand is down.

## **⚠ WARNING**

EW000054

Before going through the following steps, check the function of the sidestand switch and clutch switch. (Refer to page 3-11.)

# OPERATION AND IMPORTANT RIDING POINTS

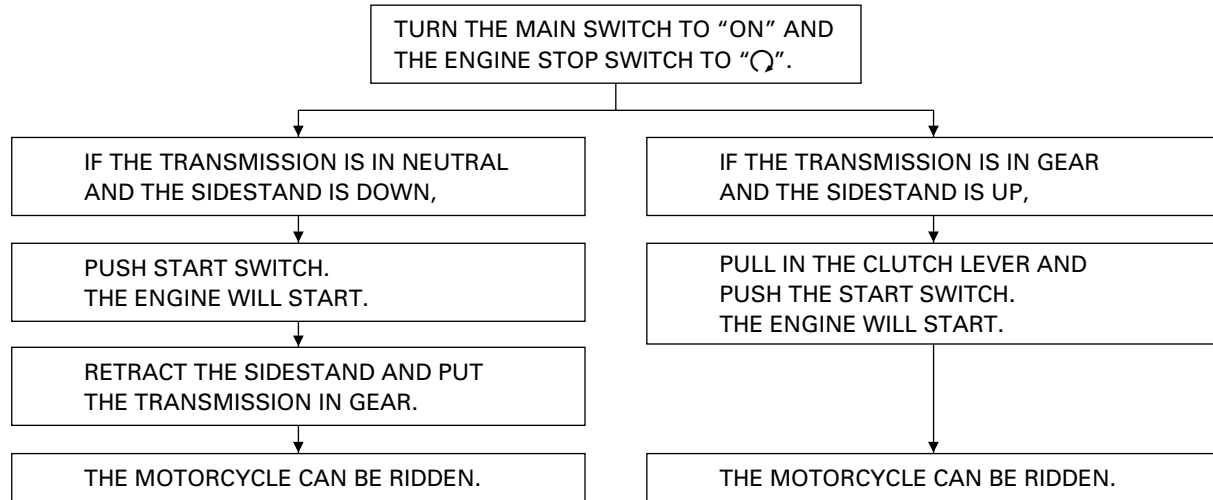

# OPERATION AND IMPORTANT RIDING POINTS

---

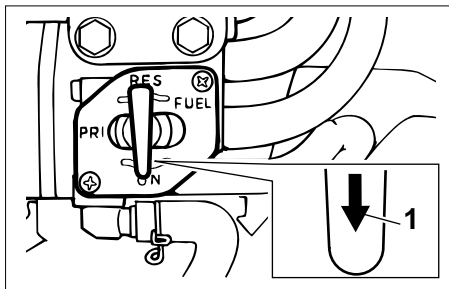

1. Arrow mark pointing to "ON"

1. Turn the fuel cock to "ON".
2. Turn the main switch to "ON" and the engine stop switch to "O".
3. Shift the transmission into neutral.

**NOTE:** \_\_\_\_\_

When the transmission is in neutral, the neutral indicator light should be on. If the light does not come on, ask a Yamaha dealer to inspect it.

4. Turn on the starter (choke) and completely close the throttle grip.
5. Start the engine by pushing the start switch.

**NOTE:** \_\_\_\_\_

If the engine fails to start, release the start switch, wait a few seconds, then try again. Each attempt should be as short as possible to preserve the battery. Do not crank the engine more than 10 seconds on any one attempt.

6. After starting the engine, move the starter (choke) to the halfway position.

**NOTE:** \_\_\_\_\_

For maximum engine life, never accelerate hard with a cold engine!

7. After warming up the engine, turn off the starter (choke) completely.

**NOTE:** \_\_\_\_\_

The engine is warm when it responds normally to the throttle with the starter (choke) turned off.

EAU01258

## Starting a warm engine

The starter (choke) is not required when the engine is warm.

EC000046

**CAUTION:** \_\_\_\_\_

**See the "Engine break-in" section prior to operating the motorcycle for the first time.**

---

EC000048

EAU02941

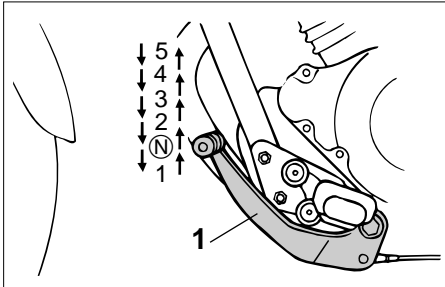

- N. Neutral
- 1. Shift pedal

EAU00423

## Shifting

The transmission lets you control the amount of power you have available at a given speed for starting, accelerating, climbing hills, etc. The use of the shift pedal is shown in the illustration.

To shift into neutral, depress the shift pedal repeatedly until it reaches the end of its travel, then raise the pedal slightly.

### CAUTION: \_\_\_\_\_

- Do not coast for long periods with the engine off, and do not tow the motorcycle a long distance. Even with gears in neutral, the transmission is only properly lubricated when the engine is running. Inadequate lubrication may damage the transmission.
- Always use the clutch when changing gears. The engine, transmission, and driveline are not designed to withstand the shock of forced shifting and can be damaged by shifting without using the clutch.

### Recommended shift points (for Switzerland only)

The recommended shift points are shown in the table below.

	Acceleration shift point (km/h)
1st → 2nd	23
2nd → 3rd	36
3rd → 4th	50
4th → 5th	60

### NOTE: \_\_\_\_\_

When shifting two gears down from 4th to 2nd, bring your motorcycle to a speed of 35 km/h.

# OPERATION AND IMPORTANT RIDING POINTS

---

## Tips for reducing fuel consumption

EAU00424

Your motorcycle's fuel consumption depends to a large extent on your riding style. The following tips can help reduce fuel consumption:

- Warm up the engine before riding.
- Turn off the starter (choke) as soon as possible.
- Shift up swiftly and avoid high engine speeds during acceleration.
- Do not double-clutch or rev the engine while shifting down and avoid high engine speeds with no load on the engine.
- Turn off the engine instead of letting it idle for an extended length of time, i.e. in traffic jams, at traffic lights or railroad crossings.

## Engine break-in

EAU00436

There is never a more important period in the life of your motorcycle than the period between zero and 1,000 km. For this reason we ask that you carefully read the following material. Because the engine is brand new, you must not put an excessive load on it for the first 1,000 km. The various parts in the engine wear and polish themselves to the correct operating clearances. During this period, prolonged full throttle operation, or any condition which might result in excessive heating of the engine, must be avoided.

## 0 ~ 150 km

EAU00443

Avoid operation above 1/3 throttle. Stop the engine and let it cool for 5 to 10 minutes after every hour of operation. Vary the speed of the motorcycle from time to time. Do not operate it at one set throttle position.

## 150 ~ 500 km

Avoid prolonged operation above 1/2 throttle. Rev the motorcycle freely through the gears, but do not use full throttle at any time.

## 500 ~ 1,000 km

Avoid cruising speeds in excess of 3/4 throttle.

EC000052

### **CAUTION:** \_\_\_\_\_

**After 1,000 km of operation, be sure to replace the engine oil and oil filter.**

---



# OPERATION AND IMPORTANT RIDING POINTS

---

## 1,000 km and beyond

Avoid prolonged full throttle operation. Vary speeds occasionally.

EC000049

### **CAUTION:**

**If any engine trouble should occur during the break-in period, consult a Yamaha dealer immediately.**

---

EAU00460

## Parking

When parking the motorcycle, stop the engine and remove the ignition key.

EW000058

### **⚠ WARNING**

**The exhaust system is hot. Park the motorcycle in a place where pedestrians or children are not likely to touch the motorcycle. Do not park the motorcycle on a slope or soft ground; the motorcycle may overturn.**

---

# PERIODIC MAINTENANCE AND MINOR REPAIR

EAU00464

Periodic inspection, adjustment and lubrication will keep your motorcycle in the safest and most efficient condition possible. Safety is an obligation of the motorcycle owner. The maintenance and lubrication schedule chart should be considered strictly as a guide to general maintenance and lubrication intervals.

**YOU MUST TAKE INTO CONSIDERATION THAT WEATHER, TERRAIN, GEOGRAPHICAL LOCATIONS, AND A VARIETY OF INDIVIDUAL USES ALL TEND TO DEMAND THAT EACH OWNER ALTER THIS TIME SCHEDULE TO SHORTER INTERVALS TO MATCH THE ENVIRONMENT.** The most important points of motorcycle inspection, adjustment, and lubrication are explained in the following pages.

EW000060

## **⚠ WARNING**

**If you are not familiar with motorcycle service, this work should be done by a Yamaha dealer.**

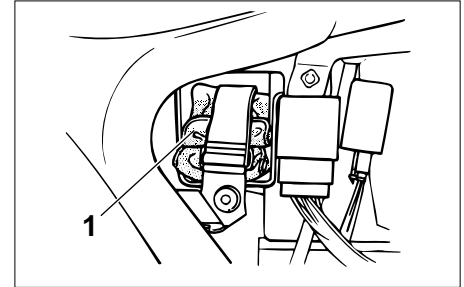

1. Tool kit

EAU01175

## **Tool kit**

The tool kit is located behind panel A. (See page 6-6 for panel removal and installation procedures.) The tools provided in the owner's tool kit are to assist you in the performance of periodic maintenance. However, some other tools such as a torque wrench are also necessary to perform the maintenance correctly.

The service information included in this manual is intended to provide you, the owner, with the necessary information for completing some of your own preventive maintenance and minor repairs.

# PERIODIC MAINTENANCE AND MINOR REPAIR

---

**NOTE:** \_\_\_\_\_

If you do not have necessary tools required during a service operation, take your motorcycle to a Yamaha dealer for service.

---

EW000063

**⚠ WARNING** \_\_\_\_\_

**Modifications to this motorcycle not approved by Yamaha may cause loss of performance, and render it unsafe for use. Consult a Yamaha dealer before attempting any changes.**

---

# PERIODIC MAINTENANCE AND MINOR REPAIR

EAU00473

## PERIODIC MAINTENANCE AND LUBRICATION

No.	ITEM	CHECKS AND MAINTENANCE JOBS	INITIAL 1,000 km	Every 6,000 km or 6 months (Whichever comes first)	Every 12,000 km or 12 months (Whichever comes first)
1	* Fuel line	<ul style="list-style-type: none"> <li>• Check fuel hoses and vacuum hose for cracks or damage.</li> <li>• Replace if necessary.</li> </ul>		√	√
2	Spark plugs	<ul style="list-style-type: none"> <li>• Check condition.</li> <li>• Clean, regap or replace if necessary.</li> </ul>	√	√	√
3	* Valves	<ul style="list-style-type: none"> <li>• Check valve clearance.</li> <li>• Adjust if necessary.</li> </ul>	√	√	√
4	Air filter	<ul style="list-style-type: none"> <li>• Clean or replace if necessary.</li> </ul>		√	√
5	* Battery	<ul style="list-style-type: none"> <li>• Check electrolyte level and specific gravity.</li> <li>• Correct or recharge if necessary.</li> <li>• Make sure that the breather hose is properly routed.</li> </ul>		√	√
6	Clutch	<ul style="list-style-type: none"> <li>• Check operation.</li> <li>• Adjust or replace cable.</li> </ul>	√	√	√
7	* Front brake	<ul style="list-style-type: none"> <li>• Check operation, fluid level and vehicle for fluid leakage. (See NOTE on page 6-5.)</li> <li>• Correct accordingly.</li> <li>• Replace brake pads if necessary.</li> </ul>	√	√	√
8	* Rear brake	<ul style="list-style-type: none"> <li>• Check operation.</li> <li>• Adjust brake pedal freeplay and replace brake shoes if necessary.</li> </ul>	√	√	√
9	* Wheels	<ul style="list-style-type: none"> <li>• Check balance, runout, spoke tightness and for damage.</li> <li>• Tighten spokes and rebalance, replace if necessary."</li> </ul>		√	√
10	* Tires	<ul style="list-style-type: none"> <li>• Check tread depth and for damage.</li> <li>• Replace if necessary.</li> <li>• Check air pressure.</li> <li>• Correct if necessary.</li> </ul>		√	√

# PERIODIC MAINTENANCE AND MINOR REPAIR

No.	ITEM	CHECKS AND MAINTENANCE JOBS	INITIAL 1,000 km	Every 6,000 km or 6 months (Whichever comes first)	Every 12,000 km or 12 months (Whichever comes first)
11	* <b>Wheel bearings</b>	<ul style="list-style-type: none"> <li>• Check bearing for looseness or damage.</li> <li>• Replace if necessary.</li> </ul>		√	√
12	* <b>Swingarm</b>	<ul style="list-style-type: none"> <li>• Check swingarm pivoting point for play.</li> <li>• Correct if necessary.</li> <li>• Lubricate with molybdenum disulfide grease every 24,000 km or 24 months (whichever comes first).</li> </ul>		√	√
13	<b>Drive chain</b>	<ul style="list-style-type: none"> <li>• Check chain slack.</li> <li>• Adjust if necessary. Make sure that the rear wheel is properly aligned.</li> <li>• Clean and lubricate.</li> </ul>	Every 1,000 km and after washing the motorcycle or riding in the rain		
14	* <b>Steering bearings</b>	<ul style="list-style-type: none"> <li>• Check bearing play and steering for roughness.</li> <li>• Correct accordingly.</li> <li>• Lubricate with lithium soap base grease every 24,000 km or 24 months (whichever comes first).</li> </ul>		√	√
15	* <b>Chassis fasteners</b>	<ul style="list-style-type: none"> <li>• Make sure that all nuts, bolts and screws are properly tightened.</li> <li>• Tighten if necessary.</li> </ul>		√	√
16	<b>Sidestand</b>	<ul style="list-style-type: none"> <li>• Check operation.</li> <li>• Lubricate and repair if necessary.</li> </ul>		√	√
17	* <b>Sidestand switch</b>	<ul style="list-style-type: none"> <li>• Check operation.</li> <li>• Replace if necessary.</li> </ul>	√	√	√
18	* <b>Front fork</b>	<ul style="list-style-type: none"> <li>• Check operation and for oil leakage.</li> <li>• Correct accordingly.</li> </ul>		√	√
19	* <b>Rear shock absorber assemblies</b>	<ul style="list-style-type: none"> <li>• Check operation and shock absorbers for oil leakage.</li> <li>• Replace shock absorber assembly if necessary.</li> </ul>		√	√
20	* <b>Carburetor</b>	<ul style="list-style-type: none"> <li>• Check engine idling speed and starter operation.</li> <li>• Adjust if necessary.</li> </ul>	√	√	√

# PERIODIC MAINTENANCE AND MINOR REPAIR

No.	ITEM	CHECKS AND MAINTENANCE JOBS	INITIAL 1,000 km	Every 6,000 km or 6 months (Whichever comes first)	Every 12,000 km or 12 months (Whichever comes first)
21	Engine oil	<ul style="list-style-type: none"> <li>• Check oil level and vehicle for oil leakage.</li> <li>• Correct if necessary.</li> <li>• Change. (Warm engine before draining.)</li> </ul>	√	√	√
22	Engine oil filter element	<ul style="list-style-type: none"> <li>• Replace.</li> </ul>	√		√

\* Since these items require special tools, data and technical skills, they should be serviced by a Yamaha dealer.

EAU02970

## NOTE:

- The air filter needs more frequent service if you are riding in unusually wet or dusty areas.
- Hydraulic brake system
  - When disassembling the master cylinder or caliper, always replace the brake fluid. Check the brake fluid level regularly and fill as required.
  - Replace the oil seals on the inner parts of the master cylinder and caliper every two years.
  - Replace the brake hoses every four years or if cracked or damaged.

# PERIODIC MAINTENANCE AND MINOR REPAIR

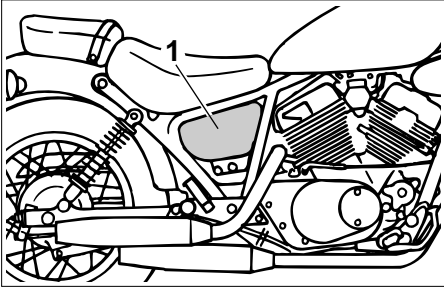

1. Panel A

EAU01122

## Panel removal and installation

The panels illustrated need to be removed to perform some of the maintenance described in this chapter.

Refer to this section each time a panel has to be removed or reinstalled.

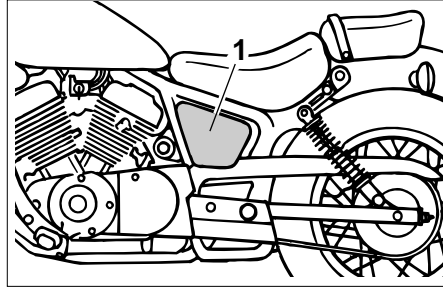

1. Panel B

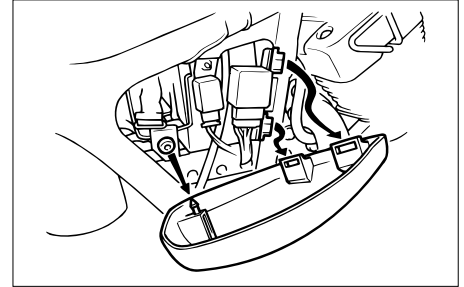

EAU01156

## Panel A

### To remove

Pull outward on the rear of the panel, then slide it forward to unhook it in the front.

# PERIODIC MAINTENANCE AND MINOR REPAIR

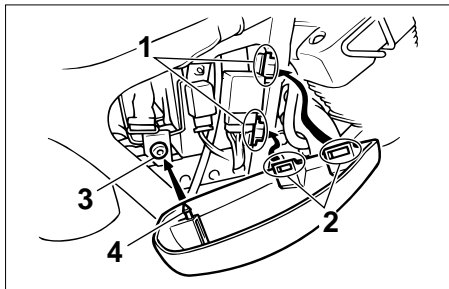

1. Holder (x2)
2. Bracket (x2)
3. Grommet
4. Projection

## To install

Hook the front of the panel on the holders, then push inward on the rear of the panel.

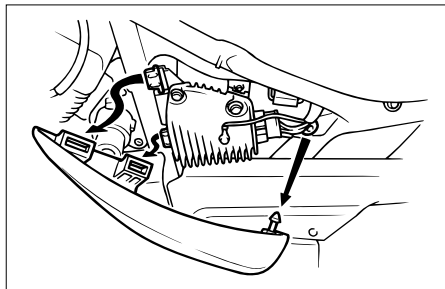

## Panel B

### To remove

Pull outward on the rear of the panel, then slide it forward to unhook it in the front.

EAU01156

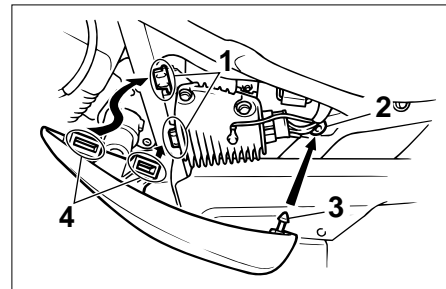

1. Holder (x2)
2. Grommet
3. Projection
4. Bracket (x2)

## To install

Hook the front of the panel on the holders, then push inward on the rear of the panel.



# PERIODIC MAINTENANCE AND MINOR REPAIR

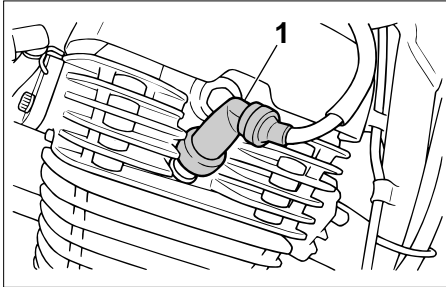

1. Spark plug cap

EAU03053

## Spark plugs Removal

1. Remove the spark plug caps.

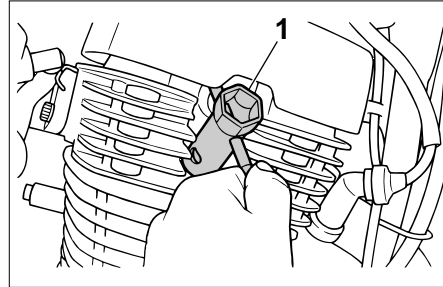

1. Spark plug wrench
2. Use the spark plug wrench in the tool kit to remove the spark plugs as shown.

## Inspection

The spark plug is an important engine component and is easy to inspect. The condition of the spark plug can indicate the condition of the engine.

Normally, all spark plugs from the same engine should have the same color on the white insulator around the center electrode. The ideal color at this point is a medium-to-light tan color for a motorcycle that is being ridden normally. If one spark plug shows a distinctly different color, there could be something wrong with the engine.

Do not attempt to diagnose such problems yourself. Instead, take the motorcycle to a Yamaha dealer. You should periodically remove and inspect the spark plugs because heat and deposits will cause any spark plug to slowly break down and erode. If electrode erosion becomes excessive, or if carbon and other deposits are excessive, you should replace the spark plug with the specified plug.

Specified spark plug:  
CR6HSA (NGK) or  
U20FSR-U (DENSO)

# PERIODIC MAINTENANCE AND MINOR REPAIR

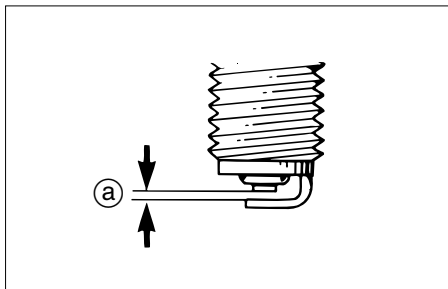

a. Spark plug gap

## Installation

1. Measure the electrode gap with a wire thickness gauge and, if necessary, adjust the gap to specification.

Spark plug gap:  
0.6 ~ 0.7 mm

2. Clean the gasket surface. Wipe off any grime from the threads.
3. Install the spark plug and tighten it to the specified torque.

Tightening torque:  
Spark plug:  
12.5 Nm (1.25 m·kg)

## NOTE:

If a torque wrench is not available when you are installing a spark plug, a good estimate of the correct torque is 1/4 to 1/2 turn past finger tight. Have the spark plug tightened to the specified torque as soon as possible.

4. Install the spark plug caps.

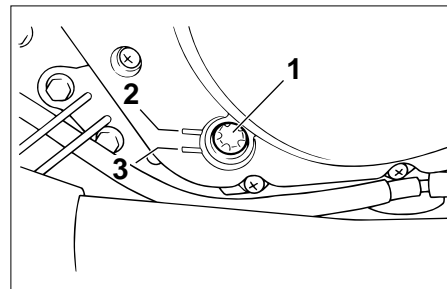

1. Oil level window
2. Maximum level mark
3. Minimum level mark

EAU01523

## Engine oil

### Oil level inspection

1. Place the motorcycle on a level place and hold it in an upright position. Warm up the engine for several minutes.

## NOTE:

Be sure the motorcycle is positioned straight up when checking the oil level. A slight tilt toward the side can result in false readings.

# PERIODIC MAINTENANCE AND MINOR REPAIR

2. With the engine stopped, check the oil level through the level window located at the lower part of the right side crankcase cover.

**NOTE:** \_\_\_\_\_

Wait a few minutes until the oil level settles before checking.

3. The oil level should be between maximum level and minimum level marks. If the level is low, fill engine with sufficient oil to raise it to the specified level.

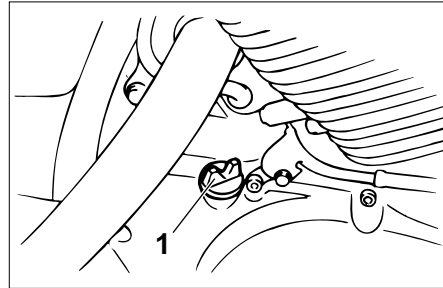

1. Oil filler cap

## Engine oil and oil filter element replacement

1. Warm up the engine for a few minutes.
2. Stop the engine. Place an oil pan under the engine and remove the oil filler cap.

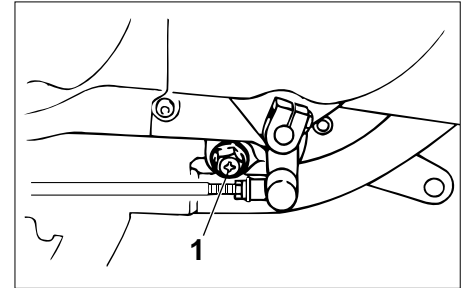

1. Engine oil drain plug

3. Remove the drain plug and drain the oil.

# PERIODIC MAINTENANCE AND MINOR REPAIR

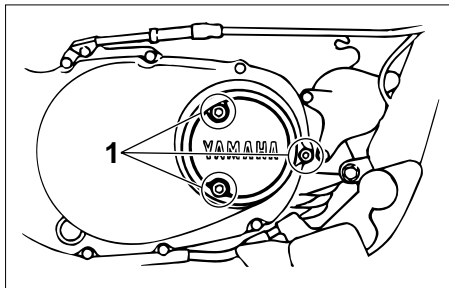

1. Oil filter cover bolt (×3)

4. Remove the oil filter cover bolts and the oil filter cover.

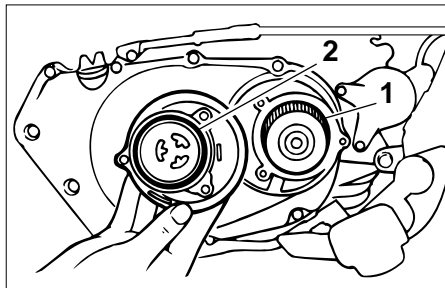

1. Oil filter

2. O-ring

5. Remove the oil filter and O-ring.

6. Reinstall the drain plug and tighten it to the specified torque.

Tightening torque:  
Drain plug:  
32 Nm (3.2 m·kg)

7. Install the new oil filter, new O-ring and the oil filter cover. Tighten the oil filter cover bolts to the specified torque.

Tightening torque:  
Oil filter cover bolt:  
10 Nm (1.0 m·kg)

**NOTE:** \_\_\_\_\_  
Make sure the O-ring is seated properly.  
\_\_\_\_\_

8. Fill the engine with oil. Install the oil filler cap and tighten it.

# PERIODIC MAINTENANCE AND MINOR REPAIR

Recommended oil:

See page 8-1.

Oil quantity:

Total amount:

1.7 L

Periodic oil change:

1.4 L

With oil filter replacement:

1.6 L

EC000066

## CAUTION:

- Do not put in any chemical additives. Engine oil also lubricates the clutch and additives could cause clutch slippage.
- Be sure no foreign material enters the crankcase.

9. Start the engine and warm up for a few minutes. While warming up, check for oil leakage. If oil leakage is found, stop the engine immediately and check for the cause.
10. Stop the engine and check the oil level.

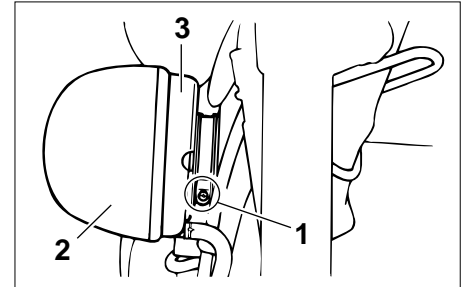

1. Bolt
2. Air filter cover
3. Air filter case

EAU01174\*

## Air filter

The air filter should be cleaned at the specified intervals. It should be cleaned more frequently if you are riding in unusually wet or dusty areas.

# PERIODIC MAINTENANCE AND MINOR REPAIR

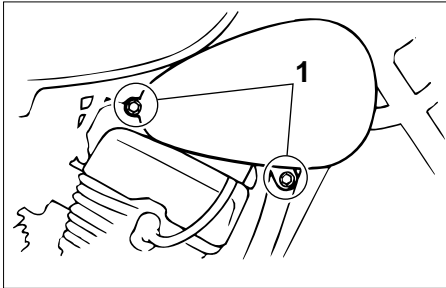

1. Bolt (x2)

1. Remove the bolts and the air filter case.

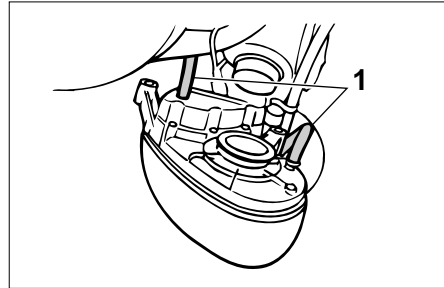

1. Hose (x2)

2. Remove the hoses from the air filter case.

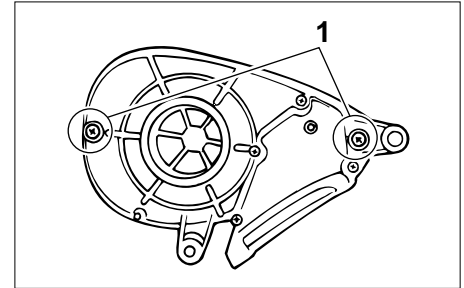

1. Screw (x2)

3. Remove the screws and the air filter cover.

# PERIODIC MAINTENANCE AND MINOR REPAIR

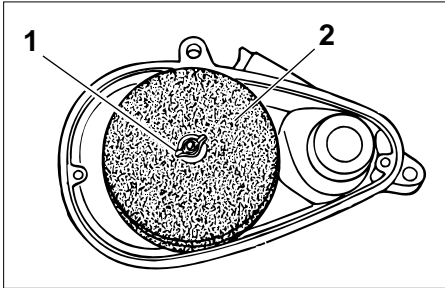

1. Wing nut
2. Air filter

4. Remove the wing nut and the air filter.

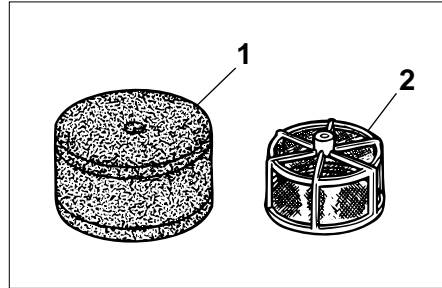

1. Foam element
2. Frame

5. Remove the foam element from its frame and clean it with solvent. After cleaning, remove the remaining solvent by squeezing it.

6. Apply recommended oil to the entire surface of the element and squeeze out the excess oil. It should be wet but not dripping.

Recommended oil:  
Engine oil

7. Pull the element over its frame, install the air filter in the case and tighten the wing nut.
8. Install the air filter cover.
9. Connect the hoses and install the air filter case.

EC000082

## CAUTION:

- **Make sure the air filter is properly seated in the air filter case.**
- **The engine should never be run without the air filter installed. Excessive piston and/or cylinder wear may result.**

# PERIODIC MAINTENANCE AND MINOR REPAIR

## Carburetor adjustment

EAU00629

The carburetor is a vital part of the engine and requires very sophisticated adjustment. Most adjustments should be left to a Yamaha dealer who has the professional knowledge and experience to do so. However, the following may be serviced by the owner as part of routine maintenance.

### CAUTION:

EC000094

The carburetor was set at the Yamaha factory after many tests. If the settings are changed, poor engine performance and damage may result.

## Idle speed adjustment

EAU01168

### NOTE:

A diagnostic tachometer must be used for this procedure.

1. Attach the tachometer. Start the engine and warm it up for a few minutes at approximately 1,000 to 2,000 r/min. Occasionally rev the engine to 4,000 to 5,000 r/min. The engine is warm when it quickly responds to the throttle.

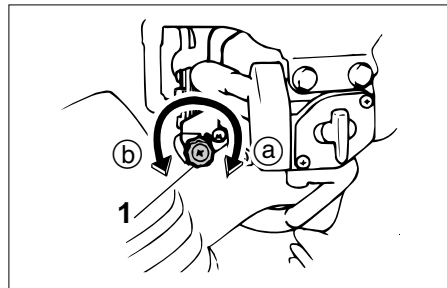

1. Throttle stop screw
2. Set the idle to the specified engine speed by adjusting the throttle stop screw. Turn the screw in direction ① to increase engine speed and in direction ② to decrease engine speed.

Standard idle speed:  
1,300 ~ 1,400 r/min

### NOTE:

If the specified idle speed cannot be obtained by performing the above adjustment, consult a Yamaha dealer.



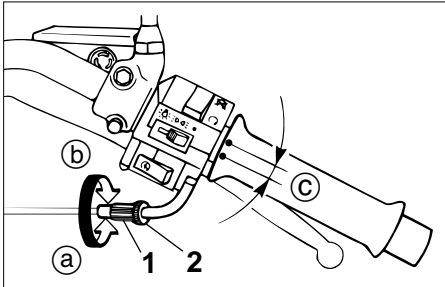

1. Adjusting nut
2. Locknut
- c. Free play

EAU00634

## Throttle cable free play adjustment

### NOTE:

Before checking the throttle cable free play, the engine idling speed should be adjusted.

Adjust the throttle cable by turning the adjusting nut so that specified free play at the throttle grip is obtained.

Free play:  
3 ~ 5 mm

1. Loosen the locknut.
2. Turn the adjusting nut in direction (a) to increase free play and in direction (b) to decrease free play.
3. Tighten the locknut.

EAU00637

## Valve clearance adjustment

The correct valve clearance changes with use, resulting in improper fuel/air supply or engine noise. To prevent this, the valve clearance must be adjusted regularly. This adjustment however, should be left to a professional Yamaha service technician.

# PERIODIC MAINTENANCE AND MINOR REPAIR

## Tires

EAU00647

To ensure maximum performance, long service, and safe operation, note the following:

### Tire air pressure

Always check and adjust the tire pressure before operating the motorcycle.

EW000082

#### **⚠WARNING**

Tire inflation pressure should be checked and adjusted when the temperature of the tire equals the ambient air temperature. Tire inflation pressure must be adjusted according to total weight of cargo, rider, passenger, and accessories (fairing, saddlebags, etc. if approved for this model), and vehicle speed.

Maximum load*	183 kg	
Cold tire pressure	Front	Rear
Up to 90 kg	175 kPa (1.75 kg/cm <sup>2</sup> , 1.75 bar)	200 kPa (2.0 kg/cm <sup>2</sup> , 2.00 bar)
90 kg load ~ Maximum load*	200 kPa (2.0 kg/cm <sup>2</sup> , 2.00 bar)	225 kPa (2.25 kg/cm <sup>2</sup> , 2.25 bar)

\* Load is the total weight of cargo, rider, passenger, and accessories.

EW000083

#### **⚠WARNING**

**Proper loading of your motorcycle is important for several characteristics of your motorcycle, such as handling, braking, performance and safety. Do not carry loosely packed items that can shift. Securely pack your heaviest items close to the center of the motorcycle, and distribute the weight evenly from side to side. Properly adjust the suspension for your load, and check the condition and pressure of your tires. NEVER OVERLOAD YOUR MOTORCYCLE. Make sure the total weight of the cargo, rider, passenger, and accessories (fairing, saddlebags, etc. if approved for this model) does not exceed the maximum load of the motorcycle. Operation of an overloaded motorcycle could cause tire damage, an accident, or even injury.**

# PERIODIC MAINTENANCE AND MINOR REPAIR

EAU00681

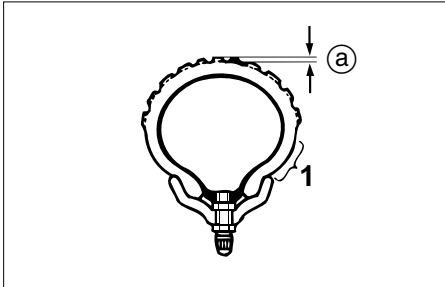

- 1. Side wall
- a. Tread depth

## Tire inspection

Always check the tires before operating the motorcycle. If center tread depth reaches the limit as shown, if the tire has a nail or glass fragments in it, or if the side wall is cracked, contact a Yamaha dealer immediately and have the tire replaced.

### FRONT

Manufacturer	Size	Type
CHENG SHIN	3.00-18 47P	C-916

### REAR

Manufacturer	Size	Type
CHENG SHIN	130/90-15M/C 66P	C-915

Minimum tire tread depth (front and rear)	1.6 mm
---	--------

### NOTE:

These limits may be different by regulation from country to country. If so, conform to the limits specified by the regulations of your own country.

## ⚠ WARNING

- Operating the motorcycle with excessively worn tires decrease riding stability and can lead to loss of control. Have excessively worn tires replaced by a Yamaha dealer immediately. Brakes, tires, and related wheel parts replacement should be left to a Yamaha Service Technician.
- Patching a punctured tube is not recommended. If it is absolutely necessary to do so, use great care and replace the tube as soon as possible with a good quality replacement.

# PERIODIC MAINTENANCE AND MINOR REPAIR

## Wheels

EAU00685

To ensure maximum performance, long service, and safe operation, note the following:

- Always inspect the wheels before a ride. Check for cracks, bends or warpage of the wheel. Be sure the spokes are tight and undamaged. If any abnormal condition exists in a wheel, consult a Yamaha dealer. Do not attempt even small repairs to the wheel. If a wheel is deformed or cracked, it must be replaced.
- Tires and wheels should be balanced whenever either one is changed or replaced. Failure to have a wheel balanced can result in poor performance, adverse handling characteristics, and shortened tire life.

- Ride at moderate speeds after changing a tire since the tire surface must first be broken in for it to develop its optimal characteristics.

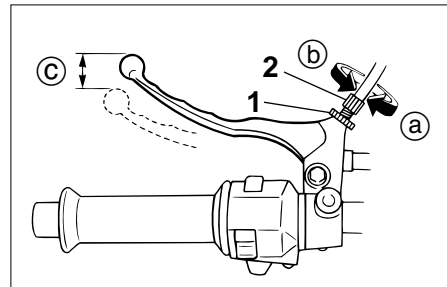

1. Locknut
2. Adjusting bolt
- c. Free play

## Clutch lever free play adjustment

EAU00694

The clutch lever free play should be adjusted to 10 ~ 15 mm.

1. Loosen the locknut at the clutch lever.
2. Turn the adjusting bolt at the clutch lever in direction (a) to increase free play or in direction (b) to decrease free play.
3. Tighten the locknut at the clutch lever.

If the specified free play cannot be obtained, proceed with the following steps.

# PERIODIC MAINTENANCE AND MINOR REPAIR

EW000099

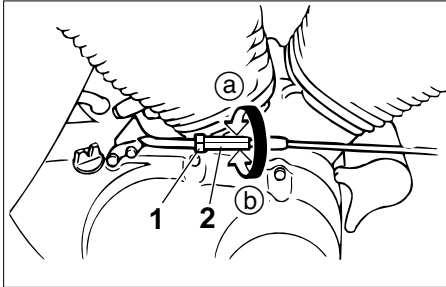

1. Locknut
2. Adjusting nut

4. Loosen the locknut at the clutch lever.
5. Turn the adjusting bolt at the clutch lever in direction (a) to loosen the cable.
6. Loosen the locknut at the crankcase side.
7. Turn the adjusting nut at the crankcase in direction (a) to increase free play or in direction (b) to decrease free play.
8. Tighten the locknut at the crankcase and the clutch lever.

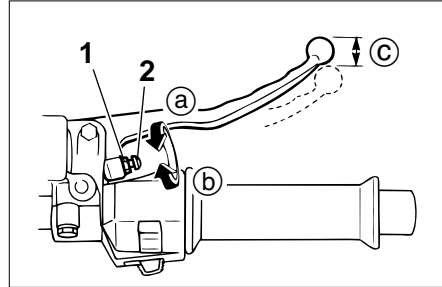

1. Locknut
2. Adjusting bolt
- c. Free play

## Front brake lever free play adjustment

EAU00696

The free play at the front brake lever should be 2 ~ 5 mm.

1. Loosen the locknut.
2. Turn the adjusting bolt in direction (a) to increase free play or in direction (b) to decrease free play.
3. After adjusting, tighten the locknut.

## ⚠ WARNING

- Check the brake lever free play. Be sure the brake is working properly.
- A soft or spongy feeling in the brake lever can indicate the presence of air in the brake system. This air must be removed by bleeding the brake system before the motorcycle is operated. Air in the system will cause greatly diminished braking capability and can result in loss of control and an accident. Have a Yamaha dealer inspect and bleed the system if necessary.

# PERIODIC MAINTENANCE AND MINOR REPAIR

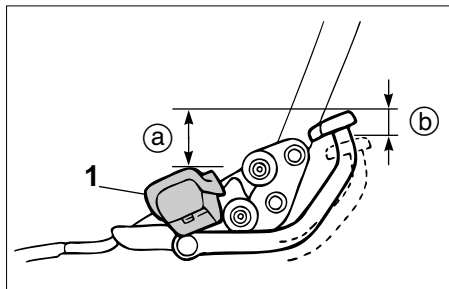

- 1. Footrest
- a. Pedal height: 60 mm
- b. Free play

## Rear brake pedal height and free play adjustment

EAU01199

EW000104

### **⚠ WARNING**

It is advisable to have a Yamaha dealer make this adjustment.

### Pedal height

The brake pedal should be positioned so that its top end is approximately 60 mm above the top of the footrest.

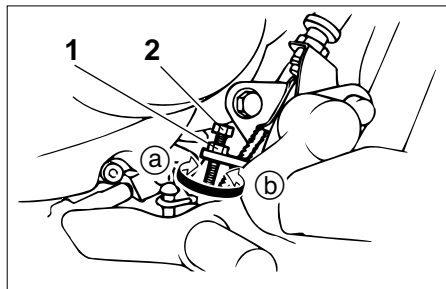

- 1. Locknut
- 2. Adjusting bolt

1. Loosen the locknut.
2. Turn the adjusting bolt in direction (a) to raise pedal height or in direction (b) to lower pedal height.
3. Tighten the locknut.

EW000108

### **⚠ WARNING**

After adjusting the pedal height, adjust brake pedal free play.

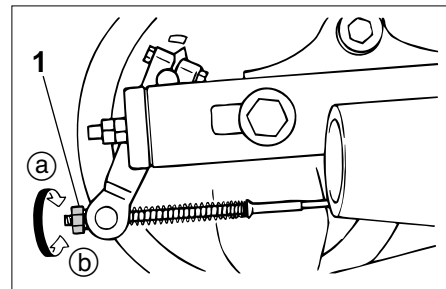

- 1. Adjusting nut

### Free play

The rear brake pedal free play should be adjusted to 20 ~ 30 mm at the brake pedal end. Turn the adjusting nut on the brake rod in direction (a) to increase free play or in direction (b) to decrease free play.

# PERIODIC MAINTENANCE AND MINOR REPAIR

## ⚠ WARNING

EW000106

- Brake pedal free play should be checked whenever the chain is adjusted or the rear wheel is removed and then reinstalled.
- Check the operation of the brake light after adjusting the rear brake.
- If it is impossible to make proper adjustment, consult a Yamaha dealer.

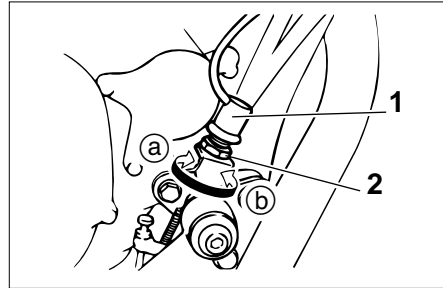

1. Brake light switch
2. Adjusting nut

## Brake light switch adjustment

EAU00713

The rear brake light switch is activated by the brake pedal and is properly adjusted when the brake light comes on just before braking takes effect. To adjust the rear brake light switch, hold the switch body so it does not rotate while turning the adjusting nut.

Turn the adjusting nut in direction (a) to make the brake light come on earlier.

Turn the adjusting nut in direction (b) to make the brake light come on later.

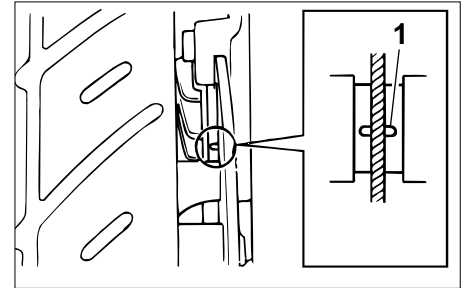

1. Indicator groove

EAU00720

## Checking the front brake pads and rear brake shoes

EAU00725

### Front brake

A wear indicator groove is provided on each brake pad. This indicator allows checking of brake pad wear without disassembling the brake. Inspect the groove. If the groove has almost disappeared, ask a Yamaha dealer to replace the pads.

# PERIODIC MAINTENANCE AND MINOR REPAIR

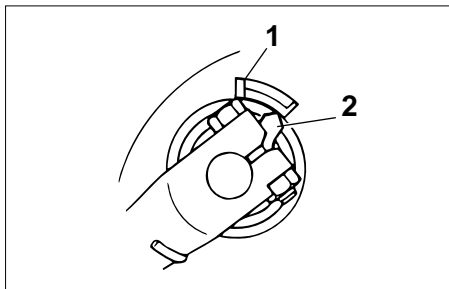

1. Wear limit line
2. Wear indicator

EAU00727

## Rear brake

Apply the brake and inspect the wear indicator.

If the indicator reaches the wear limit line, ask a Yamaha dealer to replace the shoes.

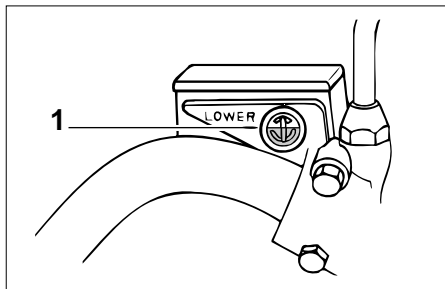

1. Minimum level mark

EAU00732

## Inspecting the brake fluid level

Insufficient brake fluid may let air enter the brake system, possibly causing the brakes to become ineffective.

Before riding, check that the brake fluid is above the minimum level and fill when necessary.

Observe these precautions:

- When checking the fluid level, make sure the top of the master cylinder is level by turning the handlebars.

- Use only the designated quality brake fluid. Otherwise, the rubber seals may deteriorate, causing leakage and poor brake performance.

Recommended brake fluid:  
DOT 4

**NOTE:** \_\_\_\_\_  
If DOT 4 is not available, DOT 3 can be used.

- Refill with the same type of brake fluid. Mixing fluids may result in a harmful chemical reaction and lead to poor brake performance.
- Be careful that water does not enter the master cylinder when refilling. Water will significantly lower the boiling point of the fluid and may result in vapor lock.



# PERIODIC MAINTENANCE AND MINOR REPAIR

- Brake fluid may deteriorate painted surfaces or plastic parts. Always clean up spilled fluid immediately.
- Have a Yamaha dealer check the cause if the brake fluid level goes down.

## Brake fluid replacement

EAU00742

The brake fluid should be replaced only by trained Yamaha service personnel. Have the Yamaha dealer replace the following components during periodic maintenance or when they are damaged or leaking:

- oil seals (every two years)
- brake hoses (every four years)

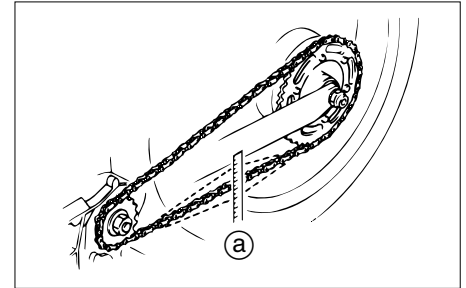

a. Chain slack

EAU00744

## Drive chain slack check

### NOTE:

Spin the wheel several times and find the tightest position of the chain. Check and/or adjust the chain slack while it's in this tightest position.

To check the chain slack the motorcycle must be held straight up with both wheels on the ground and without rider. Check the slack at the position shown in the illustration. Normal slack is approximately 30 ~ 40 mm. If the slack exceeds 40 mm, adjust.

# PERIODIC MAINTENANCE AND MINOR REPAIR

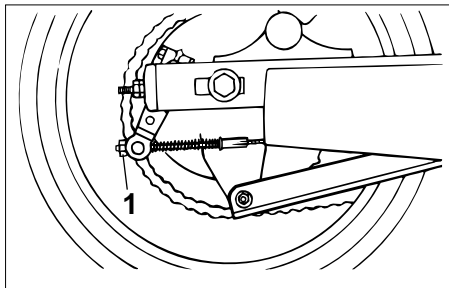

1. Rear brake pedal free play adjusting nut

EAU00750

## Drive chain slack adjustment

1. Loosen the rear brake pedal free play adjusting nut.

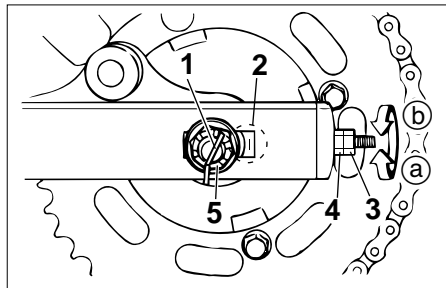

1. Cotter pin
  2. Alignment marks
  3. Locknut
  4. Chain adjusting nut
  5. Axle nut
2. Remove the cotter pin from the axle nut.
  3. Loosen the axle nut.
  4. Loosen the chain adjusting locknuts on each side of the swingarm.

To tighten the chain, turn the chain adjusting nuts in direction **a**. To loosen the chain, turn the chain adjusting nuts in direction **b** and push the wheel forward. Turn each chain adjusting nut exactly the same amount to maintain correct axle alignment. There are marks on each side of the swingarm. Use these marks to align the rear wheel.

EC000096

### CAUTION:

**Too little chain slack will overload the engine and other vital parts. Keep the slack within the specified limits.**

5. After adjusting, be sure to tighten each chain adjusting locknut. Then tighten the axle nut to the specified torque.

Tightening torque:

Axle nut:

105 Nm (10.5 m·kg)

# PERIODIC MAINTENANCE AND MINOR REPAIR

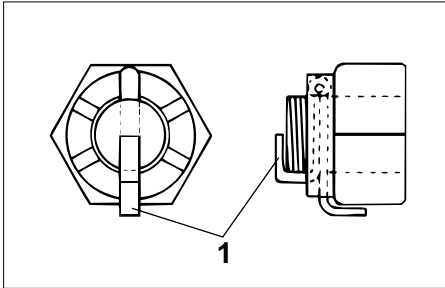

1. Cotter pin

6. Insert a new cotter pin into the axle nut and bend the end of the cotter pin as shown. If the notch in the axle nut and the cotter pin hole do not match, tighten the nut slightly to align them.

EW000110

## **⚠ WARNING**

**Always use a new cotter pin on the axle nut.**

7. Adjust the free play in the brake pedal.

EW000103

## **⚠ WARNING**

**Check the operation of the brake light after adjusting the rear brake.**

## **Drive chain lubrication**

EAU00769

The chain consists of many parts which work with each other. If the chain is not maintained properly, it will wear out quickly. Therefore, the chain must be serviced regularly. This service is especially necessary when riding in dusty areas. This motorcycle is equipped with a sealed type chain. Steam cleaning, high-pressure washes, and solvents can damage chain so do not use these for cleaning it. Use only kerosene to clean the drive chain. Wipe it dry, and thoroughly lubricate it with SAE 30 ~ 50W motor oil. Do not use any other lubricants on the drive chain. They may contain solvents that could damage the sealed chain.

# PERIODIC MAINTENANCE AND MINOR REPAIR

## CAUTION:

EC000097

Be sure to oil the chain after washing the motorcycle or riding in the rain.

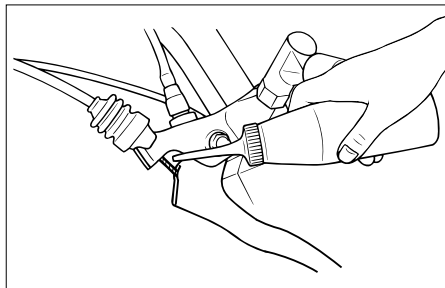

EAU02962

## Cable inspection and lubrication

EW000112

### **⚠ WARNING**

Damage to the outer housing of cables may lead to internal rusting and interfere with the cable movement. Replace damaged cables as soon as possible to prevent unsafe conditions.

Lubricate the cables and cable ends. If a cable does not operate smoothly, ask a Yamaha dealer to replace it.

Recommended lubricant:  
Engine oil

## Throttle cable and grip lubrication

EAU00773

The throttle twist grip assembly should be greased at the time that the cable is lubricated, since the grip must be removed to get at the end of the throttle cable. After removing the screws, hold the end of the cable up in the air and put in several drops of lubricant. With the throttle grip disassembled, coat the metal surface of the grip assembly with a suitable all-purpose grease.

# PERIODIC MAINTENANCE AND MINOR REPAIR

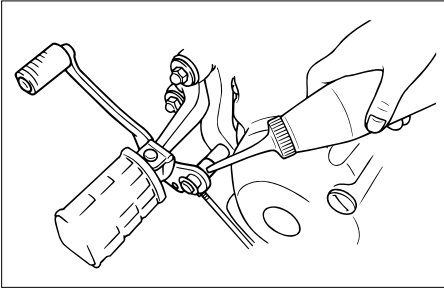

EAU02984

## Brake and shift pedal lubrication

Lubricate the pivoting parts.

Recommended lubricant:  
Engine oil

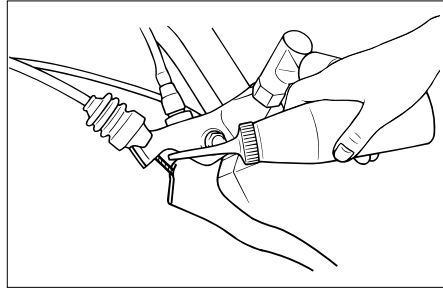

EAU02985

## Brake and clutch lever lubrication

Lubricate the pivoting parts.

Recommended lubricant:  
Engine oil

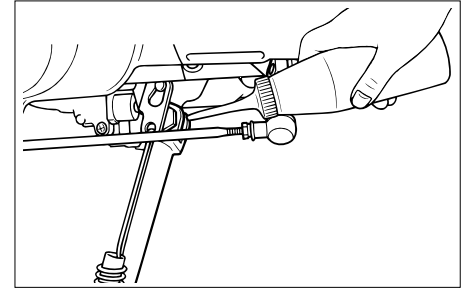

EAU02986

## Sidestand lubrication

Lubricate the sidestand pivoting point and metal-to-metal contact surfaces. Check that the sidestand moves up and down smoothly.

Recommended lubricant:  
Engine oil

EW000113

### **⚠ WARNING**

**If the sidestand does not move smoothly, consult a Yamaha dealer.**

# PERIODIC MAINTENANCE AND MINOR REPAIR

## Front fork inspection

### Visual check

EAU02939

EW000115

#### **⚠WARNING**

**Securely support the motorcycle so there is no danger of it falling over.**

Check for scratches or damage on the inner tube and excessive oil leakage from the front fork.

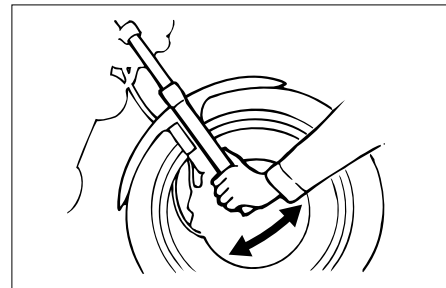
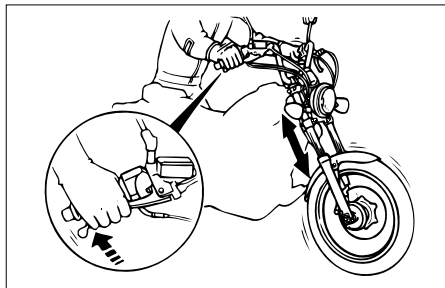

### Operation check

1. Place the motorcycle on a level place.
2. Hold the motorcycle in an upright position and apply the front brake.
3. Push down hard on the handlebars several times and check if the fork rebounds smoothly.

EC000098

#### **CAUTION:**

**If any damage or unsmooth movement is found with the front fork, consult a Yamaha dealer.**

### Steering inspection

EAU00794

Periodically inspect the condition of the steering. Worn out or loose steering bearings may be dangerous. Place a stand under the engine to raise the front wheel off the ground. Hold the lower end of the front forks and try to move them forward and backward. If any free play can be felt, ask a Yamaha dealer to inspect and adjust the steering. Inspection is easier if the front wheel is removed.

# PERIODIC MAINTENANCE AND MINOR REPAIR

## **⚠ WARNING**

EW000115

**Securely support the motorcycle so there is no danger of it falling over.**

## **Wheel bearings**

EAU01144

If there is play in the front or rear wheel hub or if the wheel does not turn smoothly, have a Yamaha dealer inspect the wheel bearings.

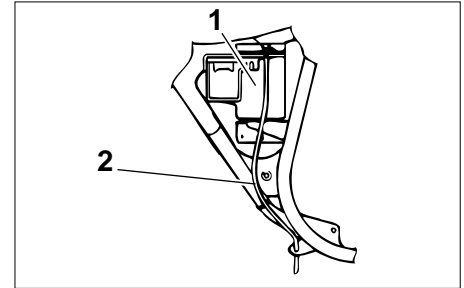

1. Battery
2. Battery breather hose

EAU01071

## **Battery**

Check the level of the battery electrolyte and make sure that the terminals are tight. Fill with distilled water if the electrolyte level is low.

# PERIODIC MAINTENANCE AND MINOR REPAIR

EC000099

## CAUTION:

When inspecting the battery, be sure the breather hose is routed correctly. If the breather hose is positioned in such a way as to cause battery electrolyte or gas to exit onto the frame, structural and cosmetic damage to the motorcycle can occur.

EW000116

## WARNING

Battery electrolyte is poisonous and dangerous, causing severe burns, etc. It contains sulfuric acid. Avoid contact with skin, eyes or clothing.

### ANTIDOTE:

- **EXTERNAL:** Flush with water.
- **INTERNAL:** Drink large quantities of water or milk. Follow with milk of magnesia, beaten egg, or vegetable oil. Call a physician immediately.
- **EYES:** Flush with water for 15 minutes and get prompt medical attention.

Batteries produce explosive gases. Keep sparks, flame, cigarettes etc., away. Ventilate when charging or using in an enclosed space. Always shield your eyes when working near batteries.

**KEEP OUT OF REACH OF CHILDREN.**

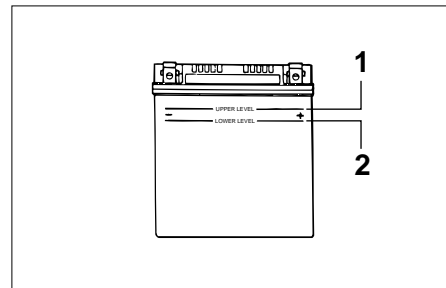

1. Maximum level mark
2. Minimum level mark

### Replenishing the battery fluid

A poorly maintained battery will corrode and discharge quickly. The battery fluid should be checked at least once a month. The level should be between the minimum level and maximum level marks. Use only distilled water if refilling is necessary.



# PERIODIC MAINTENANCE AND MINOR REPAIR

## CAUTION:

EC000100

Normal tap water contains minerals which are harmful to a battery; therefore, refill only with distilled water.

## WARNING

EW000117

Take care not to spill battery fluid on the chain. Battery fluid may weaken the chain causing shorter chain life and possibly result in an accident.

## Battery storage

- When the motorcycle will not be used for a month or longer, remove the battery, fully charge it and store it in a cool, dry place. Completely recharge the battery before reinstallation.
- If the battery will be stored for longer than two months, check the specific gravity of the fluid at least once a month and fully recharge the battery when it is too low.
- Always make sure the connections are correct when putting the battery back in the motorcycle. Make sure the breather hose is properly connected and is not damaged or obstructed.

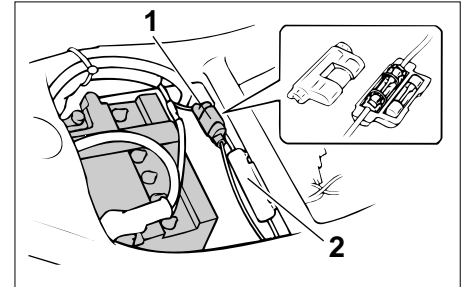

1. Main fuse
2. Signaling system fuse

EAU01073

## Fuse replacement

The fuse cases are located under the rider seat.

If a fuse is blown, turn off the main switch and the switch of the circuit in question. Install a new fuse of specified amperage. Turn on the switches and see if the electrical device operates. If the fuse immediately blows again, consult a Yamaha dealer.

# PERIODIC MAINTENANCE AND MINOR REPAIR

EC000103

## CAUTION:

Do not use fuses of higher amperage rating than those recommended. Substitution of a fuse of improper rating can cause extensive electrical system damage and possibly a fire.

Specified fuses:  
Main fuse: 20A  
Signaling system fuse: 10A

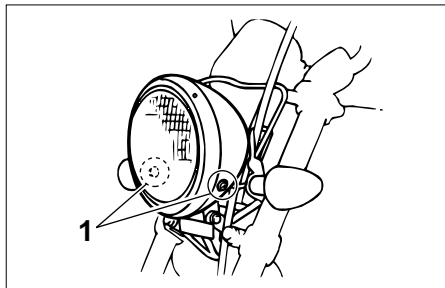

1. Screw (x2)

## Headlight bulb replacement

EAU00833

This motorcycle is equipped with a quartz bulb headlight.

If the headlight bulb burns out, replace the bulb as follows:

1. Remove the headlight unit screws.

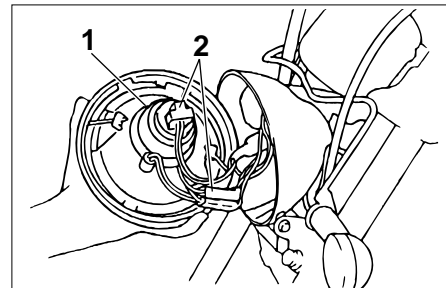

1. Bulb cover
  2. Connector (x2)
2. Remove the connectors, the headlight unit and then the bulb cover.

# PERIODIC MAINTENANCE AND MINOR REPAIR

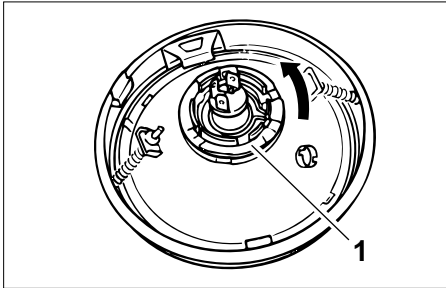

1. Bulb holder
3. Turn the bulb holder counter-clockwise to remove it and remove the defective bulb.

EW000119

## **⚠WARNING**

Keep flammable products and your hands away from a bulb while it is on, as it is hot. Do not touch a bulb until it cools down.

4. Put a new bulb into position and secure it in place with the bulb holder.

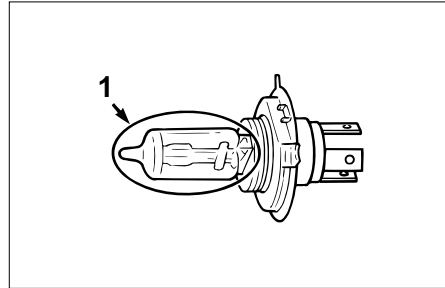

1. Don't touch

EC000105

## **CAUTION:**

Avoid touching the glass part of a bulb. Keep it free from oil; otherwise, the transparency of the glass, life of the bulb, and luminous flux will be adversely affected. If oil gets on a bulb, thoroughly clean it with a cloth moistened with alcohol or lacquer thinner.

5. Install the bulb cover, connectors and headlight unit. Ask a Yamaha dealer to adjust the headlight beam if necessary.

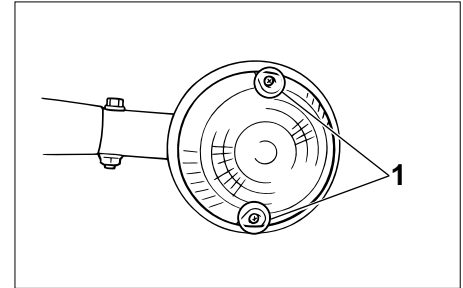

1. Screw (x2)

EAU03010

## Turn signal light bulb replacement

1. Remove the screws and the lens.

# PERIODIC MAINTENANCE AND MINOR REPAIR

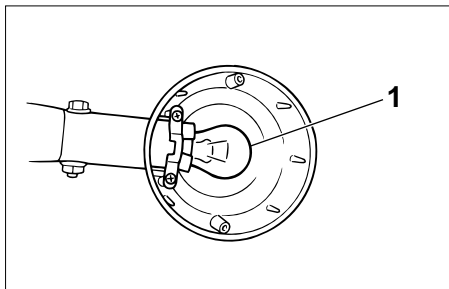

1. Bulb

2. Remove the defective bulb by pushing it inward and turning it counterclockwise.
3. Install a new bulb by pushing it inward and turning it clockwise.
4. Install the lens and tighten the screws.

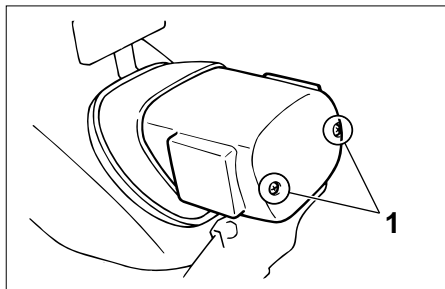

1. Screw (x2)

## Taillight bulb replacement EAU01623

1. Remove the screws and the lens.

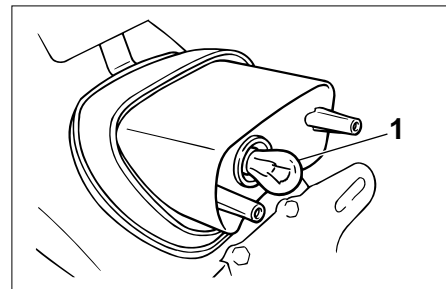

1. Bulb

2. Remove the defective bulb by pushing it inward and turning it counterclockwise.
3. Install a new bulb by pushing it inward and turning it clockwise.
4. Install the lens and tighten the screws.

EC000108

### **CAUTION:** \_\_\_\_\_

**Do not over-tighten the screws as the lens may break.**

# PERIODIC MAINTENANCE AND MINOR REPAIR

## Supporting the motorcycle

EAU00862

Since the Yamaha XV125S has no centerstand, follow these precautions when removing the front and rear wheel or performing other maintenance requiring the motorcycle to stand upright.

### Front wheel service

To stabilize the rear of the motorcycle, either use a motorcycle stand or place a motorcycle jack under the frame in front of the rear wheel to prevent it from moving from side to side. Then use a motorcycle stand to elevate the front wheel off of the ground.

### Rear wheel service

Use a motorcycle stand or motorcycle jack to elevate the motorcycle so the rear wheel is off the ground. Alternatively, two jacks can be placed under the frame or swingarm.

Check that the motorcycle is in a stable and level position before starting any maintenance. A strong wooden box can be placed under the engine for added stability.

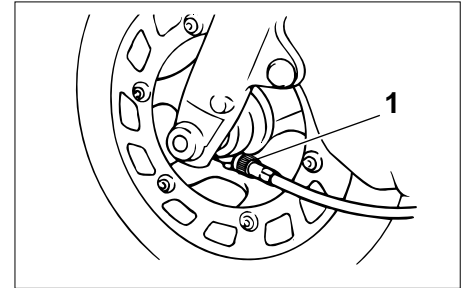

1. Speedometer cable

EAU00894

## Front wheel removal

EW000122

### **⚠ WARNING**

- It is advisable to have a Yamaha dealer service the wheel.
- Securely support the motorcycle so there is no danger of it falling over.

1. Remove the speedometer cable from the front wheel side.

# PERIODIC MAINTENANCE AND MINOR REPAIR

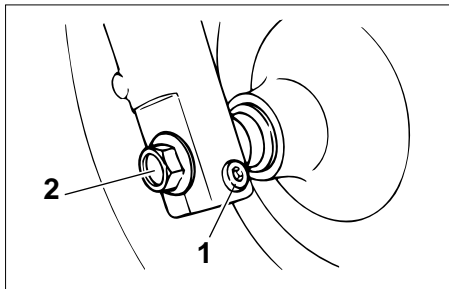

1. Pinch bolt
2. Wheel axle

2. Loosen the pinch bolt and wheel axle.
3. Elevate the front wheel by placing a suitable stand under the engine.
4. Remove the wheel axle and the front wheel.

**NOTE:** \_\_\_\_\_  
Do not depress the brake lever when the disc and caliper are separated.  
\_\_\_\_\_

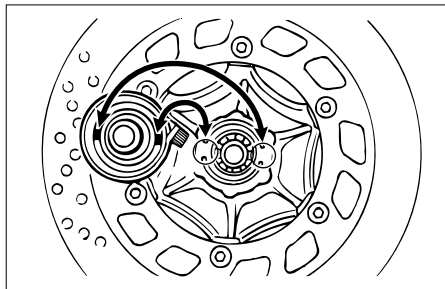

## Front wheel installation EAU01547

1. Install the speedometer gear unit into the wheel hub. Make sure the wheel hub and the speedometer gear unit housing are installed with the projections meshed into the slots.
2. Lift up the wheel between the front fork legs and guide the brake disc between the brake pads. Make sure there is enough gap between the brake pads before inserting the brake disc.

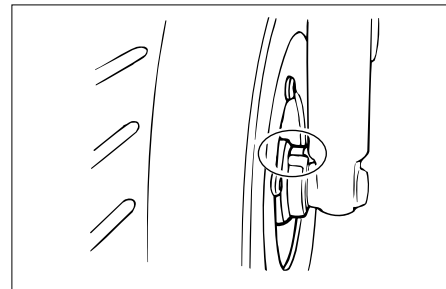

3. Make sure the slot in the speedometer gear unit fits over the stopper on the front fork outer tube.
4. Install the wheel axle and let the motorcycle down.

# PERIODIC MAINTENANCE AND MINOR REPAIR

5. Push down hard on the handlebars several times to check for proper fork operation.
6. Tightening the wheel axle to the specified torque.
7. Install the pinch bolts and tighten them to the specified torque.

Tightening torque:

Wheel axle:

59 Nm (5.9 m·kg)

Pinch bolt:

20 Nm (2.0 m·kg)

8. Install the speedometer cable.

## Rear wheel removal

EAU01550

EW000122

### **⚠ WARNING**

- It is advisable to have a Yamaha dealer service the wheel.
- Securely support the motorcycle so there is no danger of it falling over.

1. Remove the axle nut cotter pin and brake torque rod cotter pin.

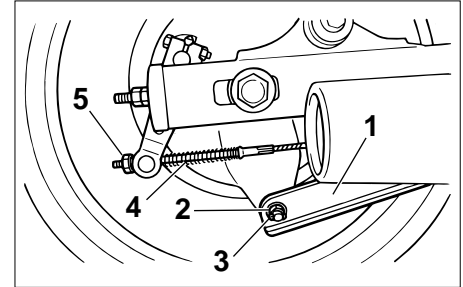

1. Brake torque rod
  2. Brake torque rod cotter pin
  3. Brake torque rod nut
  4. Brake rod
  5. Rear brake pedal free play adjusting nut
2. Loosen the axle nut and brake torque nut.
  3. Elevate the rear wheel by placing a suitable stand under the engine.
  4. Remove the brake torque rod nut and bolt from the brake shoe plate.

# PERIODIC MAINTENANCE AND MINOR REPAIR

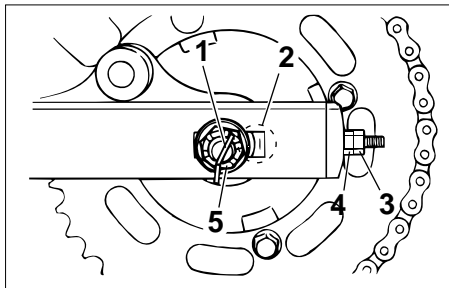

1. Cotter pin
2. Alignment marks
3. Locknut
4. Chain adjusting nut
5. Axle nut

5. Remove the rear brake pedal free play adjusting nut and brake rod from the brake cam lever.
6. Loosen the locknuts and chain adjusting nuts on each side.
7. Remove the axle nut.
8. Pull out the wheel axle and remove the wheel assembly.

## Rear wheel installation

EAU01696

1. Install the rear wheel and the axle.
2. Install the axle nut and let the motorcycle down.
3. Insert the brake rod into the brake cam lever and install the brake pedal free play adjusting nut.
4. Install the brake torque rod bolt and tighten to the specified tightening torque. Then install a new cotter pin.

### Specified torque:

Brake torque rod bolt:  
23 Nm (2.3 m·kg)

5. Adjust the drive chain free play. (See page 6-25.)
6. Tighten the axle nut to the specified tightening torque.

### Specified torque:

Axle nut:  
105 Nm (10.5 m·kg)

7. Adjust the rear brake pedal height and free play. (See page 6-21.)

## **WARNING**

**Check the operation of the brake light after adjusting the rear brake.**

EW000103



EAU01008

## Troubleshooting

Although Yamaha motorcycles receive a rigid inspection before shipment from the factory, trouble may occur during operation.

Any problem in the fuel, compression, or ignition systems can cause poor starting and loss of power. The troubleshooting chart describes a quick, easy procedure for making checks.

If your motorcycle requires any repair, bring it to a Yamaha dealer. The skilled technicians at a Yamaha dealership have the tools, experience, and know-how to properly service your motorcycle. Use only genuine Yamaha parts on your motorcycle. Imitation parts may look like Yamaha parts, but they are often inferior. Consequently, they have a shorter service life and can lead to expensive repair bills.

# PERIODIC MAINTENANCE AND MINOR REPAIR

## Troubleshooting chart

EAU01562

EW000125

### **⚠WARNING**

**Never check the fuel system while smoking or in the vicinity of an open flame.**

### 1. Fuel

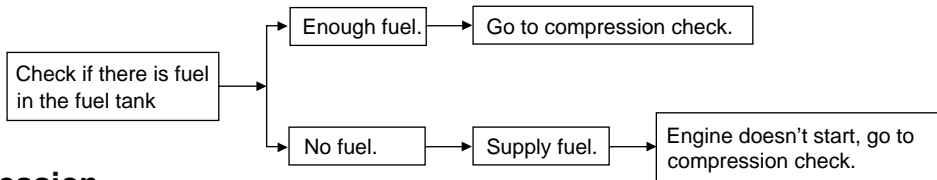

### 2. Compression

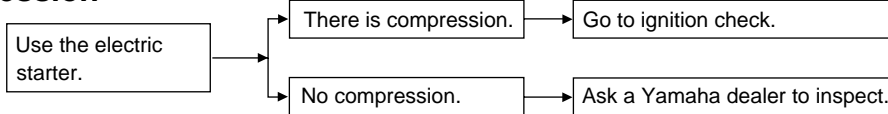

### 3. Ignition

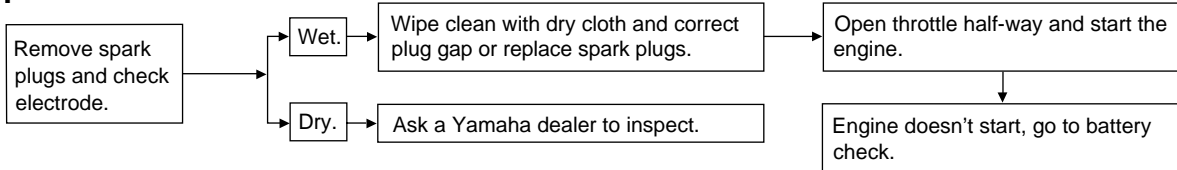

### 4. Battery

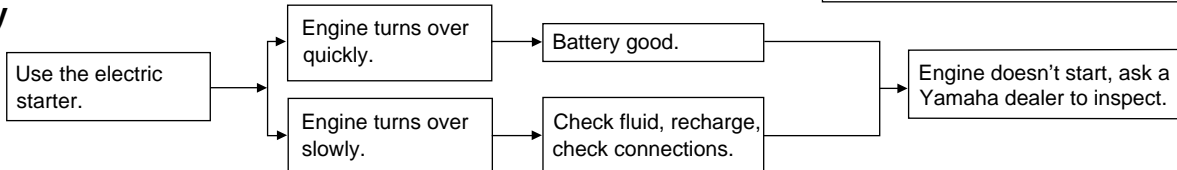

## Care

The exposure of its technology makes a motorcycle charming but also vulnerable. Although high-quality components are used, they are not all rust-resistant. While a rusty exhaust pipe may remain unnoticed on a car, it does look unattractive on a motorcycle. Frequent and proper care, however, will keep your motorcycle looking good, extend its life and maintain its performance. Moreover, the warranty states that the vehicle must be properly taken care of. For all these reasons, it is recommended that you observe the following cleaning and storing precautions.

## Before cleaning

1. Cover up the muffler outlets with plastic bags.
2. Make sure that all caps and covers as well as all electrical couplers and connectors, including the spark plug caps, are tightly installed.
3. Remove extremely stubborn dirt, like oil burnt onto the crankcase, with a degreasing agent and a brush, but never apply such products onto seals, gaskets, sprockets, the drive chain and wheel axles. Always rinse the dirt and degreaser off with water.

## Cleaning

### After normal use

Remove dirt with warm water, a neutral detergent and a soft clean sponge, then rinse with plenty of clean water. Use a tooth or bottle brush for hard-to-reach parts. Tougher dirt and insects will come off more easily if the area is covered with a wet cloth for a few minutes before cleaning.

ECA00010

### **CAUTION:** \_\_\_\_\_

- **Avoid using strong acidic wheel cleaners, especially on spoked wheels. If you do use such products for hard-to-remove dirt, do not leave it on any longer than instructed, then thoroughly rinse it off with water, immediately dry the area and apply a corrosion protection spray.**

# MOTORCYCLE CARE AND STORAGE

---

- Improper cleaning can damage windshields, cowlings, panels and other plastic parts. Use only a soft, clean cloth or sponge with mild detergent and water to clean plastic.
- Do not use any harsh chemical products on plastic parts. Be sure to avoid using cloths or sponges which have been in contact with strong or abrasive cleaning products, solvent or thinner, fuel (gasoline), rust removers or inhibitors, brake fluid, antifreeze or electrolyte.
- Do not use high-pressure washers or steam-jet cleaners since they cause water seepage and deterioration in the following areas: seals (of wheel bearings, swingarm bearings, forks and brakes), electric components (couplers, connectors, instruments, switches and lights), breather hoses and vents.
- For motorcycles equipped with a windshield: Do not use strong cleaners or hard sponges as they will cause dulling or scratching. Some cleaning compounds for plastic may leave scratches on the windshield. Test the product on a small hidden part of the windshield to make sure they do not leave any marks. If the windshield is scratched, use a quality plastic polishing compound after washing.

## After riding in the rain, near the sea or on salt-sprayed roads

Since sea salt or salt sprayed on the roads in the winter are extremely corrosive in combination with water, carry out the following steps after each ride in the rain, near the sea or on salt-sprayed roads. (Salt sprayed in the winter may remain on the roads well into spring.)

1. Clean your motorcycle with cold water and soap after the engine has cooled down.

ECA00012

### **CAUTION:** \_\_\_\_\_

**Do not use warm water since it increases the corrosive action of the salt.**

---

2. Be sure to apply a corrosion protection spray on all (even chrome- and nickel-plated) metal surfaces to prevent corrosion.

# MOTORCYCLE CARE AND STORAGE

---

## After cleaning

1. Dry the motorcycle with a chamois or an absorbing cloth.
2. Immediately dry the drive chain and lubricate it to prevent it from rusting.
3. Use a chrome polish to shine chrome, aluminum and stainless-steel parts, including the exhaust system. (Even the thermally induced discoloring of stainless-steel exhaust systems can be removed through polishing.)
4. To prevent corrosion, it is recommended to apply a corrosion protection spray on all (even chrome- and nickel-plated) metal surfaces.
5. Use spray oil as a universal cleaner to remove any remaining dirt.
6. Touch up minor paint damage caused by stones, etc.
7. Wax all painted surfaces.
8. Let the motorcycle dry completely before storing it or covering it.

## **⚠ WARNING**

EWA00001

**Make sure that there is no oil or wax on the brakes and tires. If necessary, clean the brake discs and linings with a regular brake disc cleaner or acetone, and wash the tires with warm water and mild soap. Then, carefully test the motorcycle for its braking performance and cornering behavior.**

---

## **CAUTION:**

ECA00013

- **Apply spray oil and wax sparingly and wipe off any excess.**
  - **Never apply oil or wax on rubber and plastic parts, but treat them with a suitable care product.**
  - **Avoid using abrasive polishing compounds as they wear away the paint.**
- 

## **NOTE:**

Consult a Yamaha dealer for advice on what products to use.

---

# MOTORCYCLE CARE AND STORAGE

---

## Storage

### Short-term

Always store your motorcycle in a cool, dry place and, if necessary, protect it against dust with a porous cover.

ECA00014

### CAUTION:

- **Storing the motorcycle in a poorly ventilated room or covering it with a tarp while it is still wet will allow water and humidity to seep in and cause rust.**
  - **To prevent corrosion, avoid damp cellars, stables (because of the presence of ammonia) and areas where strong chemicals are stored.**
- 

### Long-term

Before storing your motorcycle for several months:

1. Follow all the instructions in the “Care” section of this chapter.
2. Drain the carburetor float chambers by loosening the drain bolts; this will prevent fuel deposits from building up. Pour the drained fuel into the fuel tank.
3. Only for motorcycles equipped with a fuel cock which has an “OFF” position: Turn the fuel cock to “OFF”.
4. Fill up the fuel tank and add fuel stabilizer (if available) to prevent the fuel tank from rusting and the fuel from deteriorating.
5. Perform the following steps to protect the cylinders, piston rings, etc. from corrosion.
  - a. Remove the spark plug caps and spark plugs.
  - b. Pour a teaspoonful of engine oil into each spark plug bore.

- c. Install the spark plug caps onto the spark plugs and place the spark plugs on the cylinder head so that the electrodes are grounded. (This will limit sparking during the next step.)
- d. Turn the engine over several times with the starter. (This will coat the cylinder walls with oil.)
- e. Remove the spark plug caps from the spark plugs, install the spark plugs and then the spark plug caps.

EWA00003

### **⚠ WARNING**

**When turning the engine over, be sure to ground the spark plug electrodes to prevent damage or injury from sparking.**

---

6. Lubricate all control cables and the pivoting points of all levers and pedals as well as of the sidestand/centerstand.

7. Check and, if necessary, correct the tire air pressure, then raise the motorcycle so that both of its wheels are off the ground. Alternatively, turn the wheels a little every month in order to prevent the tires from becoming degraded in one spot.
8. Cover up the muffler outlets with plastic bags to prevent moisture from entering.
9. Remove the battery and fully charge it. Store it in a cool, dry place and recharge it once a month. Do not store the battery in an excessively cold or warm place (less than 0°C or more than 30°C). For more information, see “Battery storage” in the chapter “PERIODIC MAINTENANCE AND MINOR REPAIRS”.

**NOTE:** \_\_\_\_\_  
Make any necessary repairs before storing the motorcycle.  
\_\_\_\_\_

# SPECIFICATIONS

## Specifications

<b>Model</b>	<b>XV125S</b>
<b>Dimensions</b>	
Overall length	2,190 mm
Overall width	805 mm
Overall height	1,140 mm
Seat height	685 mm
Wheel base	1,495 mm
Ground clearance	145 mm
Minimum turning radius	2,800 mm
<b>Basic weight (with oil and full fuel tank)</b>	<b>147 kg</b>
<b>Engine</b>	
Engine type	Air-cooled 4-stroke, SOHC, gasoline
Cylinder arrangement	V-type 2-cylinder
Displacement	124 cm <sup>3</sup>
Bore × Stroke	41.0 × 47.0 mm
Compression ratio	10.7:1
Starting system	Electric starter
Lubrication system	Wet sump

### Engine oil

Type

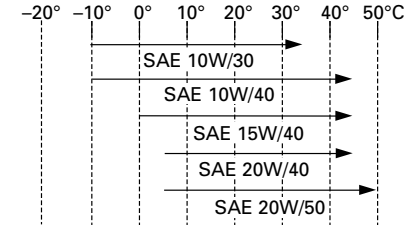

Recommended engine oil classification

API Service SE, SF, SG type or higher

### CAUTION:

**Be sure to use motor oils that do not contain anti-friction modifiers. Passenger car motor oils (often labeled "Energy Conserving") contain anti-friction additives which will cause clutch and/or starter clutch slippage, resulting in reduced component life and poor engine performance.**

Quantity

Periodic oil change	1.4 L
With oil filter replacement	1.6 L
Total amount	1.7 L

**Air filter**

Wet type element



## Fuel

Type	Regular unleaded gasoline
Fuel tank capacity	9.5 L
Reserve amount	2.6 L

## Carburetor

Type/quantity	BDS26/1
Manufacturer	MIKUNI

## Spark plug

Manufacturer / Type	NGK / CR6HSA or DENSO / U20FSR-U
Gap	0.6 ~ 0.7 mm

## Clutch type

Wet, multiple-disc

## Transmission

Primary reduction system	Spur gear
Primary reduction ratio	3.400
Secondary reduction system	Chain drive
Secondary reduction ratio	3.615
Number of sprocket teeth (Rear/Front)	47/13
Transmission type	Constant mesh 5-speed
Operation	Left foot operation

Gear ratio	1st	2.643
	2nd	1.684
	3rd	1.261
	4th	1.000
	5th	0.821

## Chassis

Frame type	Double cradle
Caster angle	32°
Trail	120 mm

## Tire

Type	With tube	
Front	Size	3.00-18 47P
	Manufacturer/ model	CHENG SHIN / C-916
Rear	Size	130/90-15 M/C 66P
	Manufacturer/ model	CHENG SHIN / C-915

# SPECIFICATIONS

Maximum load*	183 kg
Air pressure (cold tire) up to 90 kg load*	
Front	175 kPa (1.75 kg/cm <sup>2</sup> , 1.75 bar)
Rear	200 kPa (2.00 kg/cm <sup>2</sup> , 2.00 bar)
90 kg load ~ Maximum load*	
Front	200 kPa (2.00 kg/cm <sup>2</sup> , 2.00 bar)
Rear	225 kPa (2.25 kg/cm <sup>2</sup> , 2.25 bar)

\*Load is total weight of cargo, rider, passenger and accessories.

## Wheels

Front	
Type	Spoke wheel
Size	18 × 1.6
Rear	
Type	Spoke wheel
Size	15 M/C × MT 2.75

## Brakes

Front	
Type	Single disc brake
Operation	Right hand operation
Fluid	DOT 4 or DOT 3

Rear	
Type	Drum brake
Operation	Right foot operation

## Suspension

Front	
Type	Telescopic fork
Rear	
Type	Swingarm

## Shock absorbers

Front	Coil spring/oil damper
Rear	Coil spring/oil damper

## Wheel travel

Front	140 mm
Rear	100 mm

## Electrical system

Ignition system	T.C.I. (Digital)
Charging system	
Type	A.C. magneto
Standard output	14 V, 22 A @ 5,000 rpm
Battery	
Type	GM10-3A-2
Voltage, capacity	12 V, 10 AH
Headlight type	Quartz bulb (Halogen)

**Bulb voltage, wattage × quantity**

Headlight	12 V, 60 W/55 W × 1
Tail/brake light	12 V, 5 W/21 W × 1
Flasher light	12 V, 21 W × 4
Auxiliary light	12 V, 4 W × 1 (except for GB) 12 V, 3.4 W × 1 (for GB)
Meter light	12 V, 1.7 W × 1
Neutral indicator light	12 V, 1.7 W × 1
High beam indicator light	12 V, 1.7 W × 1
Turn indicator light	12 V, 3 W × 1

**Fuse**

Main	20 A
Signaling system	10 A

# SPECIFICATIONS

EAU01064

## HOW TO USE THE CONVERSION TABLE

All specification data in this manual are listed in SI and METRIC UNITS.

Use this table to convert METRIC unit data to IMPERIAL unit data.

Ex.

METRIC		MULTIPLIER	=	IMPERIAL
** mm	×	0.03937	=	** in
2 mm	×	0.03937	=	0.08 in

## CONVERSION TABLE

METRIC TO IMPERIAL			
	Metric unit	Multiplier	Imperial unit
Torque	m • kg	7.233	ft • lb
	m • kg	86.794	in • lb
	cm • kg	0.0723	ft • lb
	cm • kg	0.8679	in • lb
Weight	kg	2.205	lb
	g	0.03527	oz
Speed	km/hr	0.6214	mph
Distance	km	0.6214	mi
	m	3.281	ft
	m	1.094	yd
	cm	0.3937	in
	mm	0.03937	in
Volume/ Capacity	cc (cm <sup>3</sup> )	0.03527	oz (IMP liq.)
	cc (cm <sup>3</sup> )	0.06102	cu • in
	lt (liter)	0.8799	qt (IMP liq.)
	lt (liter)	0.2199	gal (IMP liq.)
Misc.	kg/mm	55.997	lb/in
	kg/cm <sup>2</sup>	14.2234	psi (lb/in <sup>2</sup> )
	Centigrade(°C)	9/5 + 32	Fahrenheit(°F)

## Identification number records

EAU02944

Record the key identification number, vehicle identification number and model label information in the spaces provided for assistance when ordering spare parts from a Yamaha dealer or for reference in case the vehicle is stolen.

### 1. KEY IDENTIFICATION NUMBER:

### 2. VEHICLE IDENTIFICATION NUMBER:

### 3. MODEL LABEL INFORMATION:

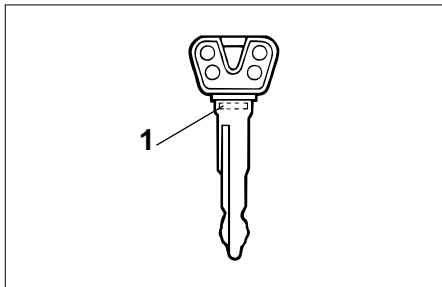

1. Key identification number

EAU01042

### Key identification number

The key identification number is stamped on the key.

Record this number in the space provided and use it for reference when obtaining a new key.

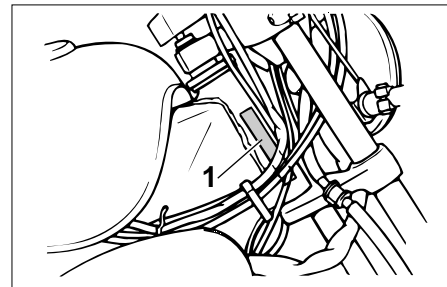

1. Vehicle identification number

EAU01043

### Vehicle identification number

The vehicle identification number is stamped into the steering head pipe.

Record this number in the space provided.

### NOTE: \_\_\_\_\_

The vehicle identification number is used to identify your motorcycle and may be used to register your motorcycle with the licensing authority in your state.

# CONSUMER INFORMATION

---

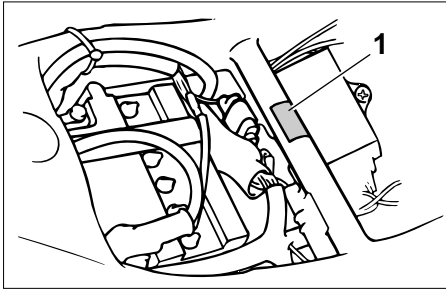

1. Model label

EAU01050

## **Model label**

The model label is affixed to the frame under the seat. (See page 3-9 for seat removal procedures.)

Record the information on this label in the space provided. This information will be needed to order spare parts from your Yamaha dealer.





PRINTED ON RECYCLED PAPER

PRINTED IN JAPAN

99-6-0.1×1(E) ㊗