



- ⚠ Read this manual carefully before operating this vehicle.
- ⚠ Il convient de lire attentivement ce manuel avant la première utilisation du véhicule.
- ⚠ Bitte lesen Sie diese Bedienungsanleitung sorgfältig durch, bevor Sie das Fahrzeug in Betrieb nehmen.

**OWNER'S MANUAL
MANUEL DU PROPRIÉTAIRE
BEDIENUNGSANLEITUNG**

TT-R110

**TT-R110E
TT-R110EB**

5B6-28199-84



PRINTED ON RECYCLED PAPER
IMPRIMÉ SUR PAPIER RECYCLÉ
AUF RECYCLINGPAPIER GEDRUCKT

PRINTED IN JAPAN
2011.06-0.5×1 CR
(E,F,G)



 Read this manual carefully before operating this vehicle.

OWNER'S MANUAL

TT-R110

TT-R110E

TT-R110EB

5B6-28199-84-E0

 **Read this manual carefully before operating this vehicle. This manual should stay with this vehicle if it is sold.**

EC Declaration of Conformity

conforming to Directive 2006/42/EC

**We, YAMAHA MOTOR CO., LTD. 2500 Shingai, Iwata, Japan,
declare in sole responsibility, that the product**

TT-R110E (JYACE17W000005186-)

(Make, model)

to which this declaration applies, conforms to the essential health
and safety requirements of Directive 2006/42/EC

(If applicable)

and to the other relevant Directives of EEC

2004/108/EC

(Title and/or number and date of issue of the other Directives of EEC)

(If applicable)

To effect correct application of the essential health and safety requirements
stated in the Directives of EEC, the following standards and/or technical
specifications were consulted:

--

(Title and/or number and date of issue of standards and/or specifications)

Authorized Representative

YAMAHA MOTOR EUROPE N.V.

Koolhovenlaan 101, 1119 NC Schiphol-Rijk, The Netherlands

Signature



Kunihiko Miwa

Executive Officer

Commuter Vehicle Section

Engineering Section

Motorcycle Business Operation

YAMAHA MOTOR CO., LTD.

Date of Issue 9 March, 2011

Congratulations on your purchase of the Yamaha TT-R110E/TT-R110EB. This model is the result of Yamaha's vast experience in the production of fine sporting, touring, and pacesetter racing machines. It represents the high degree of craftsmanship and reliability that have made Yamaha a leader in these fields.

This manual will give you an understanding of the operation, inspection, and basic maintenance of this motorcycle. If you have any questions concerning the operation or maintenance of your motorcycle, please consult a Yamaha dealer.

The design and manufacture of this Yamaha motorcycle fully comply with the emissions standards for clean air applicable at the date of manufacture. Yamaha has met these standards without reducing the performance or economy of operation of the motorcycle. To maintain these high standards, it is important that you and your Yamaha dealer pay close attention to the recommended maintenance schedules and operating instructions contained within this manual.

Yamaha continually seeks advancements in product design and quality. Therefore, while this manual contains the most current product information available at the time of printing, there may be minor discrepancies between your motorcycle and this manual. If there is any question concerning this manual, please consult a Yamaha dealer.

 WARNING

Please read this manual carefully and completely before operating this motorcycle.

 WARNING

This motorcycle is designed and manufactured for off-road use only. It is illegal to operate this motorcycle on any public street, road or highway. Such use is prohibited by law. This motorcycle complies with almost all state off-highway noise level and spark arrester laws and regulations. Please check your local riding laws and regulations before operating this motorcycle.

AN IMPORTANT SAFETY MESSAGE:

- Read this manual completely before operating your motorcycle. Make sure you understand all instructions.
- Pay close attention to the warning and notice labels on the motorcycle.
- Never operate a motorcycle without proper training or instruction.

INTRODUCTION

- Weight of the rider should not exceed 60.0 kg (132 lb).

AN IMPORTANT NOTE TO PARENTS:

This motorcycle is not a toy. Before you let your child ride this motorcycle, you should understand the instructions and warnings in this Owner's Manual. Then be sure your child understands and will follow them. Children differ in skills, physical abilities, and judgment. Some children may not be able to operate a motorcycle safely. Parents should supervise their child's use of the motorcycle at all times. Parents should permit continued use only if they determine that the child has the ability to operate the motorcycle safely.

Motorcycles are single track vehicles. Their safe use and operation are dependent upon the use of proper riding techniques as well as the expertise of the operator. Every operator should know the following requirements before riding this motorcycle.



He or she should:

- Obtain thorough instructions from a competent source on all aspects of motorcycle operation.
- Observe the warnings and maintenance requirements in this Owner's Manual.
- Obtain qualified training in safe and proper riding techniques.
- Obtain professional technical service as indicated in this Owner's Manual and/or when made necessary by mechanical conditions.

IMPORTANT MANUAL INFORMATION

EAU10132

Particularly important information is distinguished in this manual by the following notations:

	This is the safety alert symbol. It is used to alert you to potential personal injury hazards. Obey all safety messages that follow this symbol to avoid possible injury or death.
 WARNING	A WARNING indicates a hazardous situation which, if not avoided, could result in death or serious injury.
NOTICE	A NOTICE indicates special precautions that must be taken to avoid damage to the vehicle or other property.
TIP	A TIP provides key information to make procedures easier or clearer.

IMPORTANT MANUAL INFORMATION

EAU10200

**TT-R110E/TT-R110EB
OWNER'S MANUAL
©2011 by Yamaha Motor Co., Ltd.
1st edition, May 2011
All rights reserved.
Any reprinting or unauthorized use
without the written permission of
Yamaha Motor Co., Ltd.
is expressly prohibited.
Printed in Japan.**

TABLE OF CONTENTS

LOCATION OF IMPORTANT LABELS	1-1	FOR YOUR SAFETY – PRE-OPERATION CHECKS	5-1	Spoke wheels	7-17
SAFETY INFORMATION	2-1	OPERATION AND IMPORTANT RIDING POINTS	6-1	Adjusting the clutch free play	7-17
DESCRIPTION	3-1	Starting and warming up a cold engine	6-1	Adjusting the brake lever free play	7-18
Left view	3-1	Starting a warm engine	6-2	Adjusting the brake pedal free play	7-19
Right view	3-2	Shifting	6-2	Checking the shift pedal	7-19
Controls and instruments	3-3	Engine break-in	6-3	Checking the front and rear brake shoes	7-20
INSTRUMENT AND CONTROL FUNCTIONS	4-1	Parking	6-4	Drive chain slack	7-20
Main switch	4-1	PERIODIC MAINTENANCE AND ADJUSTMENT	7-1	Cleaning and lubricating the drive chain	7-22
Handlebar switches	4-1	Owner's tool kit	7-2	Checking and lubricating the cables	7-22
Shift pedal	4-2	Periodic maintenance chart for the emission control system	7-3	Checking and lubricating the throttle grip and cable	7-23
Brake lever	4-2	General maintenance and lubrication chart	7-4	Checking and lubricating the brake lever	7-23
Brake pedal	4-3	Removing and installing panels	7-7	Checking and lubricating the brake pedal	7-23
Fuel tank cap	4-3	Checking the spark plug	7-8	Checking and lubricating the sidestand	7-24
Fuel	4-3	Engine oil	7-9	Lubricating the swingarm pivots	7-24
Fuel tank breather hose	4-5	Cleaning the air filter element	7-11	Checking the front fork	7-24
Fuel cock	4-5	Cleaning the spark arrester	7-13	Checking the steering	7-25
Starter (choke) lever	4-6	Adjusting the carburetor	7-14	Checking the wheel bearings	7-25
Kickstarter	4-6	Adjusting the engine idling speed	7-14	Battery	7-26
Seat	4-7	Checking the throttle grip free play	7-15	Replacing the fuse	7-27
Shock absorber assembly	4-7	Valve clearance	7-15	Supporting the motorcycle	7-28
Sidestand	4-8	Tires	7-15	Front wheel	7-28
Starting circuit cut-off system	4-8			Rear wheel	7-30

TABLE OF CONTENTS

Troubleshooting7-32

Troubleshooting chart7-33

MOTORCYCLE CARE AND

STORAGE8-1

Matte color caution8-1

Care8-1

Storage8-3

SPECIFICATIONS9-1

CONSUMER INFORMATION.....10-1

Identification numbers10-1

LOCATION OF IMPORTANT LABELS

EAU48114

Read and understand all of the labels on your vehicle. They contain important information for safe and proper operation of your vehicle. Never remove any labels from your vehicle. If a label becomes difficult to read or comes off, a replacement label is available from your Yamaha dealer.

For Canada

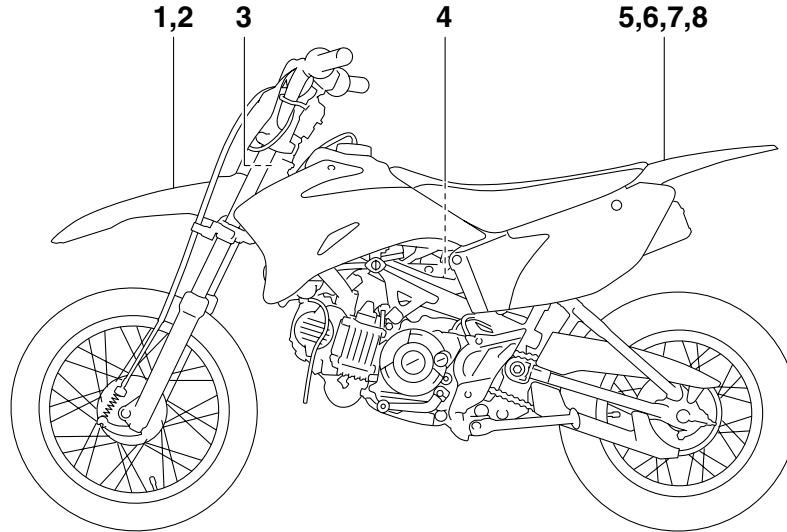

LOCATION OF IMPORTANT LABELS

For Canada

1

1

INFORMATION SUR LES PNEUS

La pression des pneus à froid doit normalement être réglée comme suit.
AVANT : 100kPa, {1.00kgf/cm²}, 15psi
ARRIERE : 100kPa, {1.00kgf/cm²}, 15psi

3RV-21668-B0

2

TIRE INFORMATION

Cold tire normal pressure should be set as follows.
FRONT : 100kPa, {1.00kgf/cm²}, 15psi
REAR : 100kPa, {1.00kgf/cm²}, 15psi

3RV-21668-A0

3



4

⚠ WARNING

This unit contains high pressure nitrogen gas. Mishandling can cause explosion.

- Read owner's manual for instructions.
- Do not incinerate, puncture or open.

⚠ AVERTISSEMENT

Cette unité contient de l'azote à haute pression. Une mauvaise manipulation peut entraîner d'explosion.

- Voir le manuel d'utilisateur pour les instructions.
- Ne pas brûler ni perforer ni ouvrir.

4AA-22259-70

LOCATION OF IMPORTANT LABELS

For Canada

5

⚠ WARNING

- BEFORE YOU OPERATE THIS VEHICLE, READ THE OWNER'S MANUAL AND ALL LABELS.
- NEVER CARRY A PASSENGER. You increase your risk of losing control if you carry a passenger.
- NEVER OPERATE THIS VEHICLE ON PUBLIC ROADS. You can collide with another vehicle if you operate this vehicle on a public road.
- ALWAYS WEAR AN APPROVED MOTORCYCLE HELMET, eye protection, and protective clothing.

3PT-2118K-A1

6

⚠ AVERTISSEMENT

- LIRE LE MANUEL DU PROPRIETAIRE AINSI QUE TOUTES LES ETIQUETTES AVANT D'UTILISER CE VEHICULE.
- NE JAMAIS TRANSPORTER DE PASSAGER. La conduite avec passager augmente les risques de perte de contrôle.
- NE JAMAIS ROULER SUR DES CHEMINS PUBLICS. Vous pourriez entrer en collision avec un autre véhicule.
- TOUJOURS PORTER UN CASQUE DE MOTOCYCLISTE APPROUVE, des lunettes et des vêtements de protection.

3PT-2118K-B0

7

This spark ignition system meets all requirements of the Canadian Interference Causing Equipment Regulations.
Ce système d'allumage par étincelle de véhicule respecte toutes les exigences du Règlement sur le matériel brouilleur du Canada.

3JK-82377-00

8

THIS VEHICLE IS A RESTRICTED USE MOTORCYCLE AND IS NOT INTENDED FOR USE ON PUBLIC HIGHWAYS.

CE VÉHICULE EST UNE MOTOCYCLETTE À USAGE RESTREINT DONT L'USAGE N'EST PAS DESTINÉ AUX VOIES PUBLIQUES.

3PT-2416E-10

1

LOCATION OF IMPORTANT LABELS

For Europe

1

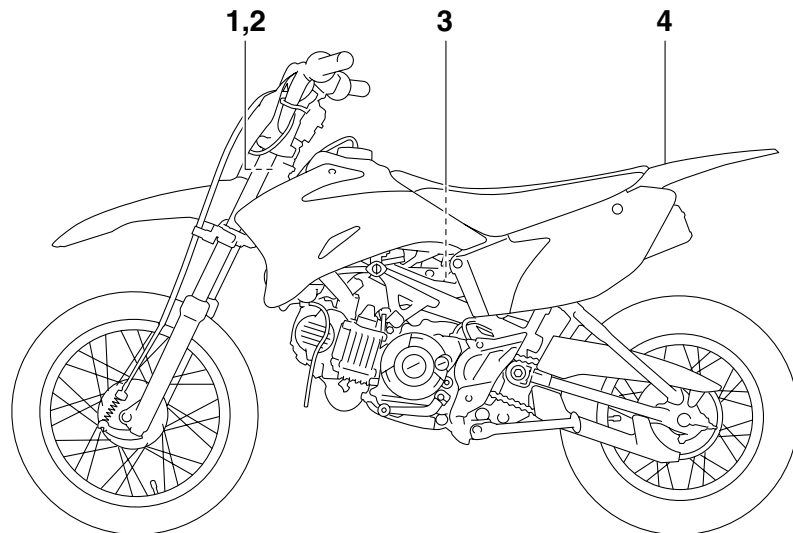

LOCATION OF IMPORTANT LABELS

For Europe

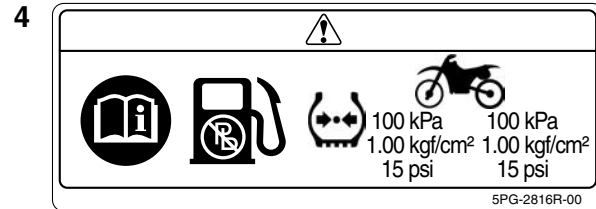
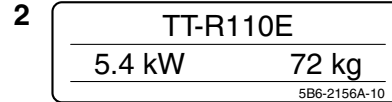

LOCATION OF IMPORTANT LABELS

Familiarize yourself with the following pictograms and read the explanatory text.

1



Read the Owner's manual.



Use unleaded gasoline only.



This unit contains high-pressure nitrogen gas. Mishandling can cause an explosion. Do not incinerate, puncture or open.



Measure the tire pressure when the tires are cold.

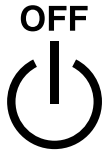

Turn off the main switch after riding to avoid draining the battery.



Adjust the tire pressure. Improper tire pressure can cause loss of control. Loss of control can result in severe injury or death.

**.* kPa **.* kPa
*** kgf/cm² *** kgf/cm²
. psi *.* psi

LOCATION OF IMPORTANT LABELS

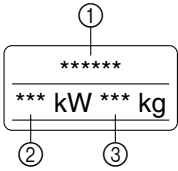
 <p>A rectangular label with a horizontal line. Above the line is the text '*****'. Below the line is the text '*** kW *** kg'. Three callout circles are present: circle 1 is above '*****', circle 2 is below 'kW', and circle 3 is below 'kg'.</p>	<ul style="list-style-type: none">① Model Name② Max. Power③ Mass In Running Order
--	---

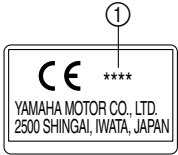
 <p>A rectangular label with a double border. At the top left is the CE mark. To its right is the text '****'. Below this is the text 'YAMAHA MOTOR CO., LTD. 2500 SHINGAI, IWATA, JAPAN'. A callout circle 1 points to the '****'.</p>	<ul style="list-style-type: none">① Year of construction
--	--

LOCATION OF IMPORTANT LABELS

For Oceania and South Africa

1

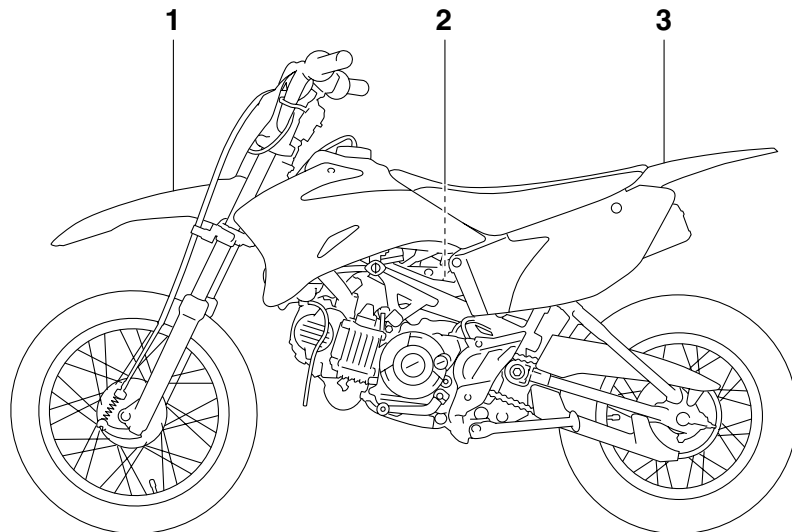

LOCATION OF IMPORTANT LABELS

For Oceania and South Africa

1

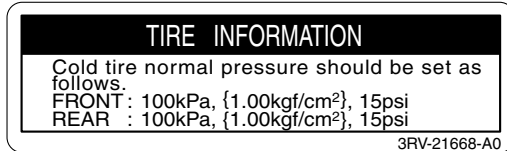

2



3



SAFETY INFORMATION

EAU4121A

2

Be a Responsible Owner

As the vehicle's owner, you are responsible for the safe and proper operation of your motorcycle.

Motorcycles are single-track vehicles. Their safe use and operation are dependent upon the use of proper riding techniques as well as the expertise of the operator. Every operator should know the following requirements before riding this motorcycle.

He or she should:

- Obtain thorough instructions from a competent source on all aspects of motorcycle operation.
- Observe the warnings and maintenance requirements in this Owner's Manual.
- Obtain qualified training in safe and proper riding techniques.
- Obtain professional technical service as indicated in this Owner's Manual and/or when made necessary by mechanical conditions.

Safe Riding

Perform the pre-operation checks each time you use the vehicle to make sure it is in safe operating condition. Failure to inspect or maintain the vehicle properly increases the possibility of an accident or equipment damage. See page 5-1 for a list of pre-operation checks.

- This motorcycle is designed for off-road use only, therefore, it is illegal to operate it on public streets, roads, or highways, even a dirt or gravel one. Off-road use on public lands may be illegal. Please check local regulations before riding.
- This motorcycle is designed to carry the operator only. No passengers.
- The failure of motorists to detect and recognize motorcycles in traffic is the predominating cause of automobile/motorcycle accidents. Many accidents have been caused by an automobile driver who did not see the motorcycle. Making

yourself conspicuous appears to be very effective in reducing the chance of this type of accident.

Therefore:

- Wear a brightly colored jacket.
- Use extra caution when you are approaching and passing through intersections, since intersections are the most likely places for motorcycle accidents to occur.
- Ride where other motorists can see you. Avoid riding in another motorist's blind spot.
- Many accidents involve inexperienced operators.
- Make sure that you are qualified and that you only lend your motorcycle to other qualified operators.
- Know your skills and limits. Staying within your limits may help you to avoid an accident.
- We recommend that you practice riding your motorcycle until you have become thoroughly familiar with the motorcycle and all of its controls.

- Many accidents have been caused by error of the motorcycle operator. A typical error made by the operator is veering wide on a turn due to excessive speed or undercornering (insufficient lean angle for the speed). Never travel faster than warranted by conditions.
- Ride cautiously in unfamiliar areas. You may encounter hidden obstacles that could cause an accident.
- The posture of the operator is important for proper control. The operator should keep both hands on the handlebar and both feet on the operator footrests during operation to maintain control of the motorcycle.
- Never ride under the influence of alcohol or other drugs.
- Be sure the transmission is in neutral before starting the engine.

Protective Apparel

The majority of fatalities from motorcycle accidents are the result of head injuries. The use of a safety helmet is the single most critical factor in the prevention or reduction of head injuries.

- Always wear an approved helmet.
- Wear a face shield or goggles. Wind in your unprotected eyes could contribute to an impairment of vision that could delay seeing a hazard.
- The use of a jacket, heavy boots, trousers, gloves, etc., is effective in preventing or reducing abrasions or lacerations.
- Never wear loose-fitting clothes, otherwise they could catch on the control levers, footrests, or wheels and cause injury or an accident.
- Always wear protective clothing that covers your legs, ankles, and feet. The engine or exhaust system become very hot during or after operation and can cause burns.

Avoid Carbon Monoxide Poisoning

All engine exhaust contains carbon monoxide, a deadly gas. Breathing carbon monoxide can cause headaches, dizziness, drowsiness, nausea, confusion, and eventually death.

Carbon Monoxide is a colorless, odorless, tasteless gas which may be present even if you do not see or smell any engine exhaust. Deadly levels of carbon monoxide can collect rapidly and you can quickly be overcome and unable to save yourself. Also, deadly levels of carbon monoxide can linger for hours or days in enclosed or poorly ventilated areas. If you experience any symptoms of carbon monoxide poisoning, leave the area immediately, get fresh air, and **SEEK MEDICAL TREATMENT**.

- Do not run engine indoors. Even if you try to ventilate engine exhaust with fans or open windows and doors, carbon monoxide can rapidly reach dangerous levels.
- Do not run engine in poorly ventilated or partially enclosed areas such as barns, garages, or carports.

SAFETY INFORMATION

- Do not run engine outdoors where engine exhaust can be drawn into a building through openings such as windows and doors.

2

Loading

Adding accessories to your motorcycle can adversely affect stability and handling if the weight distribution of the motorcycle is changed. To avoid the possibility of an accident, use extreme caution when adding accessories to your motorcycle. Use extra care when riding a motorcycle that has added accessories. Here are some general guidelines to follow if adding accessories to your motorcycle:

Operation of an overloaded vehicle could cause an accident.

- The weight of the operator must not exceed 60.0 kg (132 lb).
- Accessory weight should be kept as low and close to the motorcycle as possible. Securely pack your heaviest items as close to the center of the vehicle as possible and make sure to distribute the weight

as evenly as possible on both sides of the motorcycle to minimize imbalance or instability.

- Shifting weights can create a sudden imbalance. Make sure that accessories are securely attached to the motorcycle before riding. Check accessory mounts frequently.
 - Properly adjust the suspension for your load (suspension-adjustable models only), and check the condition and pressure of your tires.
 - Never attach any large or heavy items to the handlebar, front fork, or front fender.

Genuine Yamaha Accessories

Choosing accessories for your vehicle is an important decision. Genuine Yamaha accessories, which are available only from a Yamaha dealer, have been designed, tested, and approved by Yamaha for use on your vehicle.

Many companies with no connection to Yamaha manufacture parts and accessories or offer other modifications for Yamaha vehicles. Yamaha is not in a

position to test the products that these aftermarket companies produce. Therefore, Yamaha can neither endorse nor recommend the use of accessories not sold by Yamaha or modifications not specifically recommended by Yamaha, even if sold and installed by a Yamaha dealer.

Aftermarket Parts, Accessories, and Modifications

While you may find aftermarket products similar in design and quality to genuine Yamaha accessories, recognize that some aftermarket accessories or modifications are not suitable because of potential safety hazards to you or others. Installing aftermarket products or having other modifications performed to your vehicle that change any of the vehicle's design or operation characteristics can put you and others at greater risk of serious injury or death. You are responsible for injuries related to changes in the vehicle.

Keep the following guidelines in mind, as well as those provided under "Loading" when mounting accessories.

- Never install accessories that would impair the performance of your motorcycle. Carefully inspect the accessory before using it to make sure that it does not in any way reduce ground clearance or cornering clearance, limit suspension travel, steering travel or control operation.
- Accessories fitted to the handlebar or the front fork area can create instability due to improper weight distribution. If accessories are added to the handlebar or front fork area, they must be as lightweight as possible and should be kept to a minimum.
- Bulky or large accessories may seriously affect the stability of the motorcycle. Wind may attempt to lift the motorcycle, or the motorcycle may become unstable in cross winds.
- Certain accessories can displace the operator from his or her normal riding position. This improper position limits the freedom of movement of the opera-

tor and may limit control ability, therefore, such accessories are not recommended.

- Use caution when adding electrical accessories. If electrical accessories exceed the capacity of the motorcycle's electrical system, an electric failure could result, which could cause a dangerous loss of lights or engine power.

Aftermarket Tires and Rims

The tires and rims that came with your motorcycle were designed to match the performance capabilities and to provide the best combination of handling, braking, and comfort. Other tires, rims, sizes, and combinations may not be appropriate. Refer to page 7-15 for tire specifications and more information on replacing your tires.

Transporting the Motorcycle

Be sure to observe following instructions before transporting the motorcycle in another vehicle.

- Remove all loose items from the motorcycle.

- Check that the fuel cock (if equipped) is in the "OFF" position and that there are no fuel leaks.
- Point the front wheel straight ahead on the trailer or in the truck bed, and choke it in a rail to prevent movement.
- Shift the transmission in gear (for models with a manual transmission).
- Secure the motorcycle with tie-downs or suitable straps that are attached to solid parts of the motorcycle, such as the frame or upper front fork triple clamp (and not, for example, to rubber-mounted handlebars or turn signals, or parts that could break). Choose the location for the straps carefully so the straps will not rub against painted surfaces during transport.
- The suspension should be compressed somewhat by the tie-downs, if possible, so that the motorcycle will not bounce excessively during transport.

DESCRIPTION

EAU10410

Left view

3

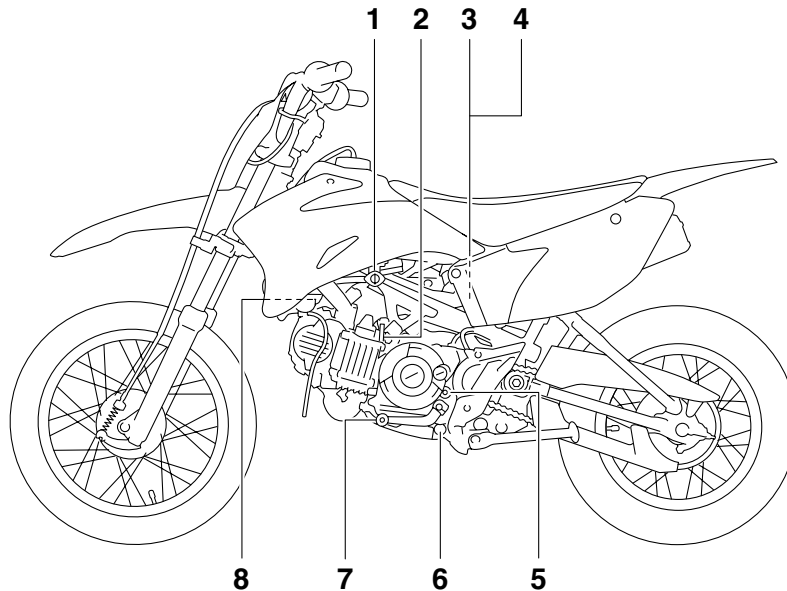

1. Fuel cock (page 4-5)
2. Starter (choke) lever (page 4-6)
3. Fuse (page 7-27)
4. Battery (page 7-26)
5. Clutch adjusting screw (page 7-17)
6. Engine oil drain bolt (page 7-9)
7. Shift pedal (page 4-2)
8. Throttle stop screw (page 7-14)

Right view

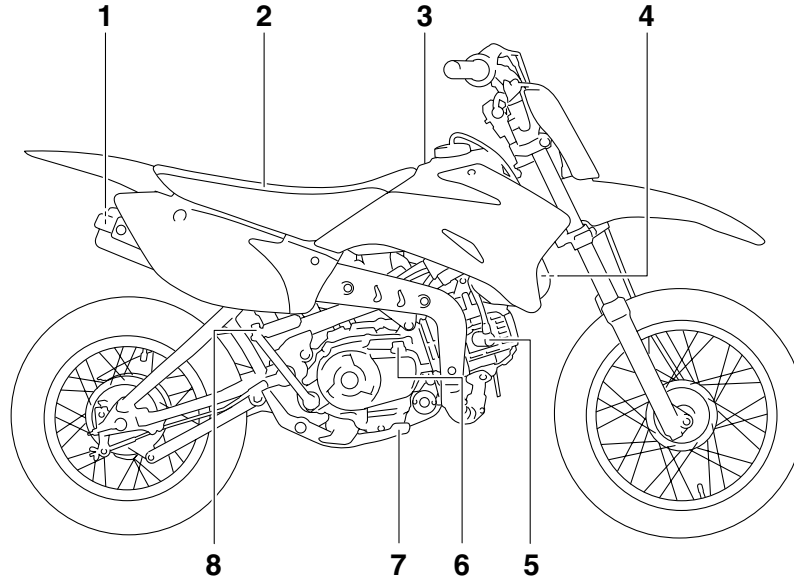

1. Spark arrester (page 7-13)
2. Seat (page 4-7)
3. Fuel tank (page 4-3)
4. Air filter element (page 7-11)
5. Spark plug cap (page 7-8)
6. Engine oil filler cap (page 7-9)
7. Brake pedal (page 4-3)
8. Kickstarter (page 4-6)

DESCRIPTION

EAU10430

Controls and instruments

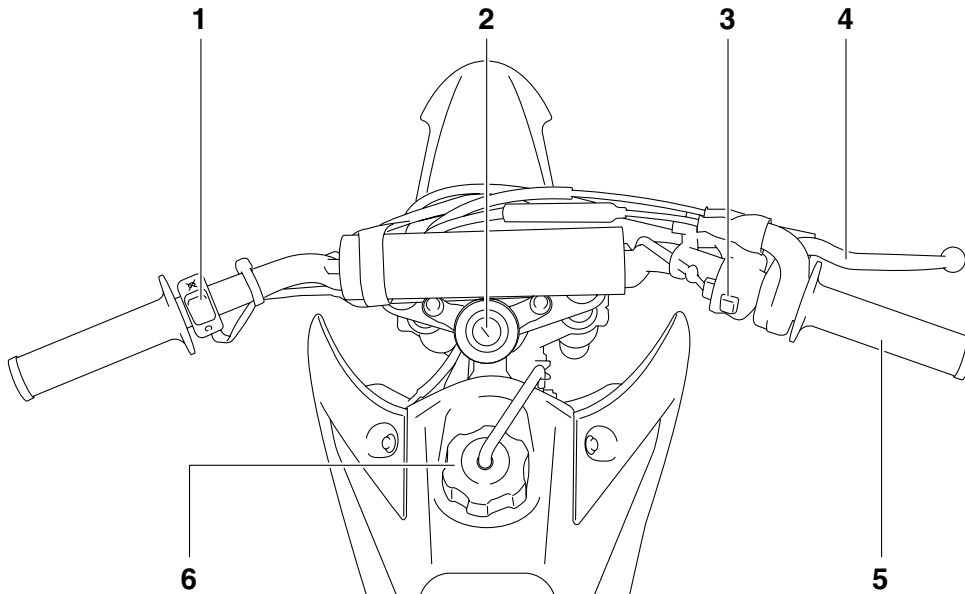

1. Engine stop switch (page 4-1)
2. Main switch (page 4-1)
3. Start switch (page 4-1)
4. Brake lever (page 4-2)
5. Throttle grip (page 7-15)
6. Fuel tank cap (page 4-3)

Main switch

EAU40340

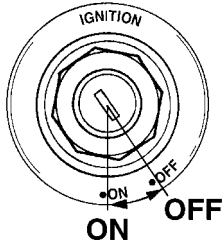

The main switch controls the ignition system. The main switch positions are described below.

ON

EAU10630

All electrical systems are supplied with power, and the engine can be started. The key cannot be removed.

OFF

EAU45751

All electrical systems are off. The key can be removed.

WARNING

EWA10072

Never turn the key to "OFF" while the vehicle is moving, otherwise the electrical systems will be switched off, which may result in loss of control or an accident.

Handlebar switches

EAU12348

Left

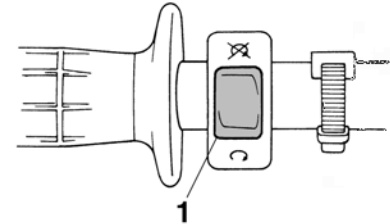

1. Engine stop switch "⊙/⊗"

Right

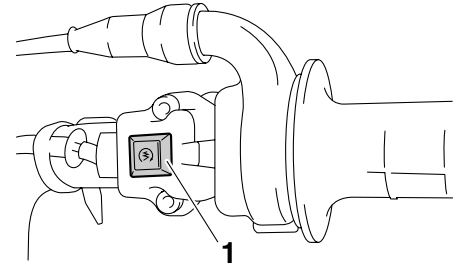



1. Start switch "⊕"

INSTRUMENT AND CONTROL FUNCTIONS

Engine stop switch “/”

EAU12660

Set this switch to “” before starting the engine. Set this switch to “” to stop the engine in case of an emergency, such as when the vehicle overturns or when the throttle cable is stuck.

Start switch “”

EAU12711

Push this switch to crank the engine with the starter. See page 6-1 for starting instructions prior to starting the engine.

Shift pedal

EAU39851

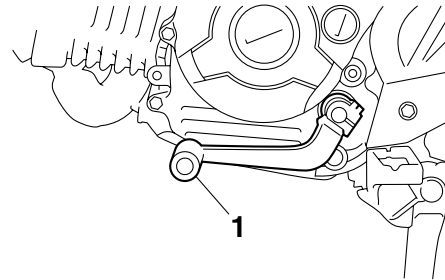

1. Shift pedal

This motorcycle is equipped with a constant-mesh 4-speed transmission. The shift pedal is located on the left side of the motorcycle. Neutral is at the bottom position.

Brake lever

EAU12890

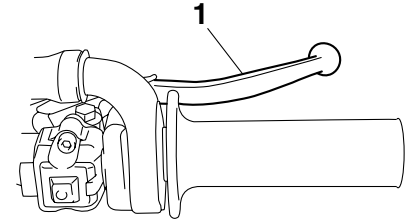

1. Brake lever

The brake lever is located at the right handlebar grip. To apply the front brake, pull the lever toward the handlebar grip.

Brake pedal

EAU12941

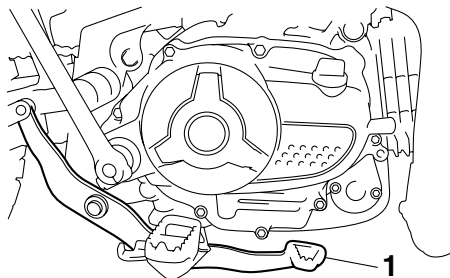

1. Brake pedal

The brake pedal is on the right side of the motorcycle. To apply the rear brake, press down on the brake pedal.

Fuel tank cap

EAU13182

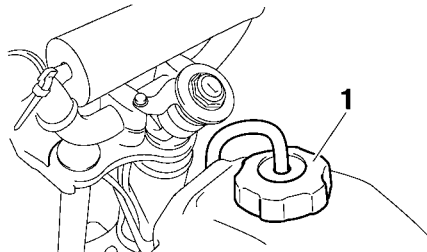

1. Fuel tank cap

To remove the fuel tank cap, turn it counterclockwise, and then pull it off. To install the fuel tank cap, insert it into the tank opening, and then turn it clockwise.

! WARNING

Make sure that the fuel tank cap is properly closed after filling fuel. Leaking fuel is a fire hazard.

EWA11091

Fuel

EAU13212

Make sure there is sufficient gasoline in the tank.

EWA10881

! WARNING

Gasoline and gasoline vapors are extremely flammable. To avoid fires and explosions and to reduce the risk of injury when refueling, follow these instructions.

1. Before refueling, turn off the engine and be sure that no one is sitting on the vehicle. Never refuel while smoking, or while in the vicinity of sparks, open flames, or other sources of ignition such as the pilot lights of water heaters and clothes dryers.
2. Do not overfill the fuel tank. Stop filling when the fuel reaches the bottom of the filler tube. Because fuel expands when it heats up, heat from the engine or the sun can cause fuel to spill out of the fuel tank.

INSTRUMENT AND CONTROL FUNCTIONS

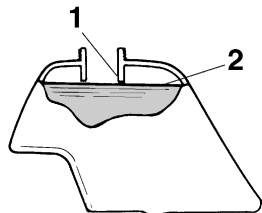

4

1. Fuel tank filler tube
2. Maximum fuel level
3. Wipe up any spilled fuel immediately. **NOTICE: Immediately wipe off spilled fuel with a clean, dry, soft cloth, since fuel may deteriorate painted surfaces or plastic parts.** [ECA10071]
4. Be sure to securely close the fuel tank cap.

EWA15151

WARNING

Gasoline is poisonous and can cause injury or death. Handle gasoline with care. Never siphon gasoline by mouth. If you should swallow some gasoline or inhale a lot of gasoline vapor, or get some gasoline in your eyes, see your doctor immedi-

ately. If gasoline spills on your skin, wash with soap and water. If gasoline spills on your clothing, change your clothes.

EAU50250

Recommended fuel:

TT-R110E Regular unleaded gasoline or gasohol (E10)
TT-R110EB Regular unleaded gasoline or gasohol (E10) (CAN)(ZAF)
TT-R110EB Unleaded gasoline or gasohol (E10) (AUS)

Fuel tank capacity:

3.8 L (1.00 US gal, 0.84 Imp.gal)

Fuel reserve amount:

0.5 L (0.13 US gal, 0.11 Imp.gal)

ECA11400

NOTICE

Use only unleaded gasoline. The use of leaded gasoline will cause severe damage to internal engine parts, such as the valves and piston rings, as well as to the exhaust system.

Your Yamaha engine has been designed to use regular unleaded gasoline with a pump octane number $[(R+M)/2]$ of 86 or higher, or a research

octane number of 91 or higher. If knocking (or pinging) occurs, use a gasoline of a different brand or premium unleaded fuel. Use of unleaded fuel will extend spark plug life and reduce maintenance costs.

Gasohol

There are two types of gasohol: gasohol containing ethanol and that containing methanol. Gasohol containing ethanol can be used if the ethanol content does not exceed 10% (E10). Gasohol containing methanol is not recommended by Yamaha because it can cause damage to the fuel system or vehicle performance problems.

INSTRUMENT AND CONTROL FUNCTIONS

Fuel tank breather hose

EAU13412

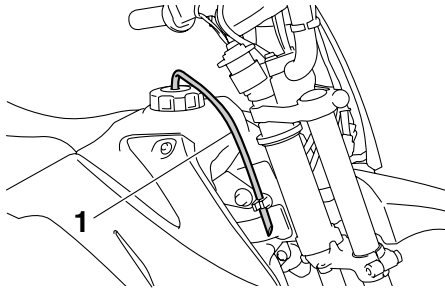

1. Fuel tank breather hose

Before operating the motorcycle:

- Check the fuel tank breather hose connection.
- Check the fuel tank breather hose for cracks or damage, and replace it if damaged.
- Make sure that the fuel tank breather hose is not blocked, and clean it if necessary.

Fuel cock

EAU13561

The fuel cock supplies fuel from the tank to the carburetor while filtering it also.

The fuel cock has three positions:

OFF

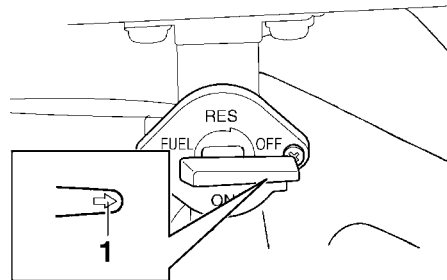

1. Arrow mark positioned over "OFF"

With the lever in this position, fuel will not flow. Always return the lever to this position when the engine is not running.

ON

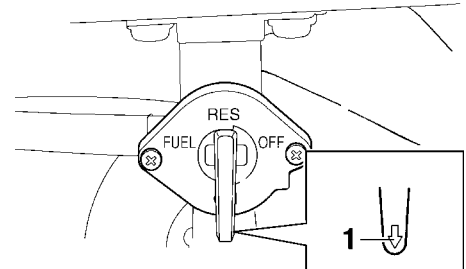

1. Arrow mark positioned over "ON"

With the lever in this position, fuel flows to the carburetor. Normal riding is done with the lever in this position.

RES

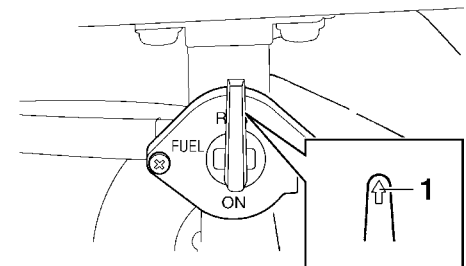

1. Arrow mark positioned over "RES"

INSTRUMENT AND CONTROL FUNCTIONS

This indicates reserve. If you run out of fuel while riding, move the lever to this position. Fill the tank at the first opportunity. Be sure to set the lever back to “ON” after refueling!

4

Starter (choke) lever “” EAU13590

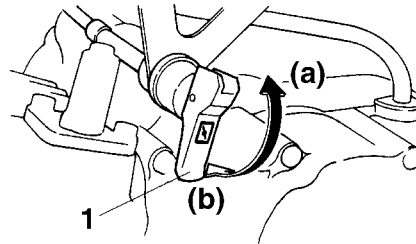

1. Starter (choke) lever “”

Starting a cold engine requires a richer air-fuel mixture, which is supplied by the starter (choke).

Move the lever in direction (a) to turn on the starter (choke).

Move the lever in direction (b) to turn off the starter (choke).

Kickstarter EAU37650

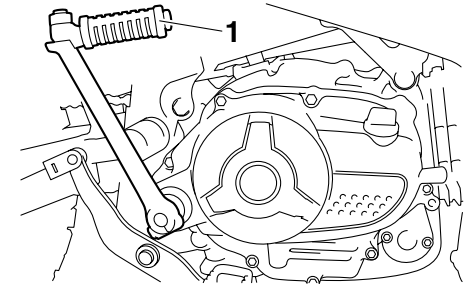

1. Kickstarter lever

If the engine fails to start by pushing the start switch, try to start it by using the kickstarter. To start the engine, fold out the kickstarter lever, move it down lightly with your foot until the gears engage, and then push it down smoothly but forcefully.

Seat

EAU46281

To remove the seat

Remove the bolts, and then slide the seat to the rear and pull upward.

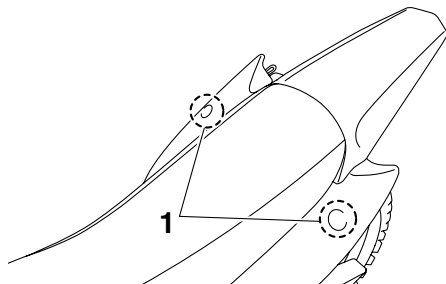

1. Bolt

To install the seat

1. Fit the slot in the seat onto the projection on the fuel tank, and insert the projection on the seat into the seat holder as shown.

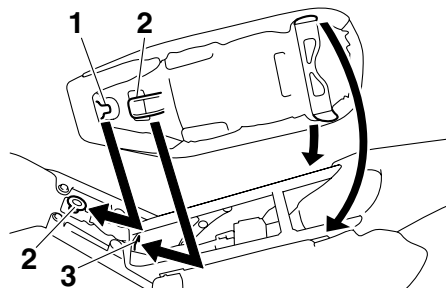

1. Slot
2. Projection
3. Seat holder

2. Place the seat in the original position, and then tighten the bolts.

TIP

Make sure that the seat is properly secured before riding.

Shock absorber assembly

EAU46021

EWA10221

⚠ WARNING

This shock absorber assembly contains highly pressurized nitrogen gas. Read and understand the following information before handling the shock absorber assembly.

- Do not tamper with or attempt to open the cylinder assembly.
- Do not subject the shock absorber assembly to an open flame or other high heat source. This may cause the unit to explode due to excessive gas pressure.
- Do not deform or damage the cylinder in any way. Cylinder damage will result in poor damping performance.
- Do not dispose of a damaged or worn-out shock absorber assembly yourself. Take the shock absorber assembly to a Yamaha dealer for any service.

INSTRUMENT AND CONTROL FUNCTIONS

Sidestand

EAU37490

The sidestand is located on the left side of the frame. Raise the sidestand or lower it with your foot while holding the vehicle upright.

EWA14190



The vehicle must not be ridden with the sidestand down, or if the sidestand cannot be properly moved up (or does not stay up), otherwise the sidestand could contact the ground and distract the operator, resulting in a possible loss of control.

Starting circuit cut-off system

EAU41611

The starting circuit cut-off system prevents starting when the transmission is in gear.

Periodically check the operation of the starting circuit cut-off system according to the following procedure.

TIP

This check is most reliable if performed with a warmed-up engine.

INSTRUMENT AND CONTROL FUNCTIONS

With the engine turned off:
1. Make sure that the engine stop switch is set to “○”.
2. Turn the key to “ON”.
3. Shift the transmission into gear.
4. Keep the front or rear brake applied.
5. Push the start switch.
Does the engine start?

NO YES

6. Shift the transmission into the neutral position.
7. Push the start switch.
Does the engine start?

YES NO

The system is OK. **The motorcycle can be ridden.**

WARNING

If a malfunction is noted, have a Yamaha dealer check the system before riding.

The neutral switch may not be working correctly.
The motorcycle should not be ridden until checked by a Yamaha dealer.

The neutral switch may not be working correctly.
The motorcycle should not be ridden until checked by a Yamaha dealer.

FOR YOUR SAFETY – PRE-OPERATION CHECKS

EAU15596

Inspect your vehicle each time you use it to make sure the vehicle is in safe operating condition. Always follow the inspection and maintenance procedures and schedules described in the Owner's Manual.

EWA11151

WARNING

Failure to inspect or maintain the vehicle properly increases the possibility of an accident or equipment damage. Do not operate the vehicle if you find any problem. If a problem cannot be corrected by the procedures provided in this manual, have the vehicle inspected by a Yamaha dealer.

Before using this vehicle, check the following points:

ITEM	CHECKS	PAGE
Fuel	<ul style="list-style-type: none">• Check fuel level in fuel tank.• Refuel if necessary.• Check fuel line for leakage.• Check fuel tank breather hose for obstructions, cracks or damage, and check hose connection.	4-3, 4-5
Engine oil	<ul style="list-style-type: none">• Check oil level in engine.• If necessary, add recommended oil to specified level.• Check vehicle for oil leakage.	7-9
Front brake	<ul style="list-style-type: none">• Check operation.• Lubricate cable if necessary.• Check lever free play.• Adjust if necessary.	7-18, 7-20
Rear brake	<ul style="list-style-type: none">• Check operation.• Check pedal free play.• Adjust if necessary.	7-19, 7-20
Throttle grip	<ul style="list-style-type: none">• Make sure that operation is smooth.• Check throttle grip free play.• If necessary, have Yamaha dealer adjust throttle grip free play and lubricate cable and grip housing.	7-15, 7-23

FOR YOUR SAFETY – PRE-OPERATION CHECKS

ITEM	CHECKS	PAGE
Control cables	<ul style="list-style-type: none"> • Make sure that operation is smooth. • Lubricate if necessary. 	7-22
Drive chain	<ul style="list-style-type: none"> • Check chain slack. • Adjust if necessary. • Check chain condition. • Lubricate if necessary. 	7-20, 7-22
Wheels and tires	<ul style="list-style-type: none"> • Check for damage. • Check tire condition and tread depth. • Check air pressure. • Correct if necessary. 	7-15, 7-17
Shift pedal	<ul style="list-style-type: none"> • Make sure that operation is smooth. • Correct if necessary. 	7-19
Brake pedal	<ul style="list-style-type: none"> • Make sure that operation is smooth. • Lubricate pedal pivoting point if necessary. 	7-23
Brake lever	<ul style="list-style-type: none"> • Make sure that operation is smooth. • Lubricate lever pivoting point if necessary. 	7-23
Sidestand	<ul style="list-style-type: none"> • Make sure that operation is smooth. • Lubricate pivot if necessary. 	7-24
Chassis fasteners	<ul style="list-style-type: none"> • Make sure that all nuts, bolts and screws are properly tightened. • Tighten if necessary. 	—
Engine stop switch	<ul style="list-style-type: none"> • Check operation. 	4-1

OPERATION AND IMPORTANT RIDING POINTS

EAU15951

Read the Owner's Manual carefully to become familiar with all controls. If there is a control or function you do not understand, ask your Yamaha dealer.

EWA10271

WARNING

Failure to familiarize yourself with the controls can lead to loss of control, which could cause an accident or injury.

EAU44814

Starting and warming up a cold engine

1. Turn the fuel cock lever to "ON".
2. Turn the key to "ON" and make sure that the engine stop switch is set to "○".
3. Shift the transmission into the neutral position.

EWA14410

WARNING

- Be sure to shift the transmission into neutral before starting the engine.
- Never ride with the sidestand down.

4. Turn the starter (choke) on and completely close the throttle. (See page 4-6.)
5. Start the engine by pushing the start switch or by pushing the kick-starter lever down.
6. When the engine is warm, turn the starter (choke) off.

TIP

The engine is warm when it responds quickly to the throttle with the starter (choke) turned off.

ECA11042

NOTICE

For maximum engine life, never accelerate hard when the engine is cold!

OPERATION AND IMPORTANT RIDING POINTS

Starting a warm engine

EAU16640

Follow the same procedure as for starting a cold engine with the exception that the starter (choke) is not required when the engine is warm.

Shifting

EAU39901

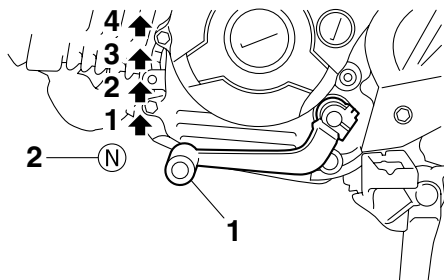

1. Shift pedal
2. Neutral position

This motorcycle has a 4-speed transmission with a centrifugal, automatic clutch. Shifting gears lets you control the amount of engine power available for starting off, accelerating, climbing hills, etc.

The gear positions are shown in the illustration.

TIP

To shift the transmission into the neutral position, press the shift pedal down repeatedly until it reaches the end of its travel.

NOTICE

ECA15441

- Even with the transmission in the neutral position, do not coast for long periods of time with the engine off, and do not tow the motorcycle for long distances. The transmission is properly lubricated only when the engine is running. Inadequate lubrication may damage the transmission.
- Always release the throttle grip before changing gears to avoid damaging the engine, transmission, and drive train, which are not designed to withstand the shock of shifting when the throttle grip is open.

6

EAU39911

To start out and accelerate

1. Close the throttle.
2. Shift into first gear and release the shift pedal. **NOTICE:** Always close the throttle before shifting gears, otherwise damage to the engine and drive train may result. [ECA15461]

OPERATION AND IMPORTANT RIDING POINTS

3. Open the throttle gradually.
4. Once the motorcycle has reached a speed high enough to change gears, close the throttle.
5. Shift into second gear and release the shift pedal.
6. Open the throttle gradually.
7. Follow the same procedure when shifting to the next higher gear.

EAU16710

To decelerate

1. Close the throttle and apply both the front and the rear brakes to slow the motorcycle.
2. Downshift through the gears and shift the transmission into the neutral position when the motorcycle is almost completely stopped.

Engine break-in

EAU39920

There is never a more important period in the life of your engine than the first 5 hours of riding. It is also important to acustom the rider to the motorcycle during this time. Please read the following information carefully.

Since the engine is brand new, do not put an excessive load on it for the first 5 hours of operation. The various parts in the engine wear and polish themselves to the correct operating clearances. During this period, prolonged full-throttle operation or any condition that might result in engine overheating must be avoided. However, momentary full-throttle operation under load (i.e., two to three seconds maximum) does not harm the engine. Each full-throttle acceleration should be followed with a substantial rest period for the engine. To allow the engine to cool down from the temporary buildup of heat, cruise at a lower engine speed.

After the first 5 hours of operation, thoroughly check the motorcycle for loose parts, oil leakage and any other problems. Be sure to inspect and make ad-

justments thoroughly, especially cable and drive chain slack and loose spokes. In addition, check all fittings and fasteners for looseness, and tighten if necessary.

ECA10270

NOTICE

If any engine trouble should occur during the engine break-in period, immediately have a Yamaha dealer check the vehicle.

EAU17171

Parking

When parking, stop the engine, remove the key from the main switch, and then turn the fuel cock lever to “OFF”.

EWA10311

WARNING

- **Since the engine and exhaust system can become very hot, park in a place where pedestrians or children are not likely to touch them and be burned.**
 - **Do not park on a slope or on soft ground, otherwise the vehicle may overturn, increasing the risk of a fuel leak and fire.**
 - **Do not park near grass or other flammable materials which might catch fire.**
-

PERIODIC MAINTENANCE AND ADJUSTMENT

EAU17244

EWA15122

EAU17302

Periodic inspection, adjustment, and lubrication will keep your vehicle in the safest and most efficient condition possible. Safety is an obligation of the vehicle owner/operator. The most important points of vehicle inspection, adjustment, and lubrication are explained on the following pages.

The intervals given in the periodic maintenance charts should be simply considered as a general guide under normal riding conditions. However, depending on the weather, terrain, geographical location, and individual use, the maintenance intervals may need to be shortened.

WARNING

Turn off the engine when performing maintenance unless otherwise specified.

- **A running engine has moving parts that can catch on body parts or clothing and electrical parts that can cause shocks or fires.**
- **Running the engine while servicing can lead to eye injury, burns, fire, or carbon monoxide poisoning – possibly leading to death. See page 2-2 for more information about carbon monoxide.**

Emission controls not only function to ensure cleaner air, but are also vital to proper engine operation and maximum performance. In the following periodic maintenance charts, the services related to emissions control are grouped separately. These services require specialized data, knowledge, and equipment. Maintenance, replacement, or repair of the emission control devices and systems may be performed by any repair establishment or individual that is certified (if applicable). Yamaha dealers are trained and equipped to perform these particular services.

7

EWA10321

EWA15460

WARNING

Failure to properly maintain the vehicle or performing maintenance activities incorrectly may increase your risk of injury or death during service or while using the vehicle. If you are not familiar with vehicle service, have a Yamaha dealer perform service.

WARNING

Brake discs, calipers, drums, and linings can become very hot during use. To avoid possible burns, let brake components cool before touching them.

EAU17311

Owner's tool kit

The service information included in this manual and the tools provided in the owner's tool kit are intended to assist you in the performance of preventive maintenance and minor repairs. However, additional tools such as a torque wrench may be necessary to perform certain maintenance work correctly.

TIP _____

If you do not have the tools or experience required for a particular job, have a Yamaha dealer perform it for you.

PERIODIC MAINTENANCE AND ADJUSTMENT

EAU39944

Periodic maintenance chart for the emission control system

TIP

- From 7000 km (4200 mi) or 18 months, repeat the maintenance intervals starting from 3000 km (1800 mi) or 6 months.
- Items marked with an asterisk should be performed by a Yamaha dealer as they require special tools, data and technical skills.

No.	ITEM	CHECKS AND MAINTENANCE JOBS	INITIAL	ODOMETER READINGS	
			1000 km (600 mi) or 1 month or 30 hours	3000 km (1800 mi) or 6 months or 90 hours	5000 km (3000 mi) or 12 months or 150 hours
1	* Fuel line	<ul style="list-style-type: none"> • Check fuel hoses for cracks or damage. • Replace if necessary. 		√	√
2	Spark plug	<ul style="list-style-type: none"> • Check condition. • Adjust gap and clean. 		√	√
3	* Valve clearance	<ul style="list-style-type: none"> • Check and adjust valve clearance when engine is cold. 			√
4	Air filter element	<ul style="list-style-type: none"> • Clean with solvent. • Replace if necessary. 		√	√
5	* Crankcase breather system	<ul style="list-style-type: none"> • Check ventilation hose for cracks or damage and drain any deposits. • Replace if necessary. 	√	√	√
6	* Carburetor	<ul style="list-style-type: none"> • Check engine idling speed and starter operation. • Adjust if necessary. 	√	√	√
7	Exhaust system	<ul style="list-style-type: none"> • Check for leakage. • Tighten if necessary. • Replace gasket(s) if necessary. 		√	√
8	* Spark arrester	<ul style="list-style-type: none"> • Clean. 			√
9	Engine oil	<ul style="list-style-type: none"> • Change (warm engine before draining). 	√	√	√

7

PERIODIC MAINTENANCE AND ADJUSTMENT

EAU3534B

General maintenance and lubrication chart

TIP

- From 7000 km (4200 mi) or 18 months, repeat the maintenance intervals starting from 3000 km (1800 mi) or 6 months.
- Items marked with an asterisk should be performed by a Yamaha dealer as they require special tools, data and technical skills.

No.	ITEM	CHECKS AND MAINTENANCE JOBS	INITIAL	ODOMETER READINGS	
			1000 km (600 mi) or 1 month or 30 hours	3000 km (1800 mi) or 6 months or 90 hours	5000 km (3000 mi) or 12 months or 150 hours
1	* Clutch	<ul style="list-style-type: none"> • Check operation. • Adjust if necessary. 	√	√	√
2	* Front brake	<ul style="list-style-type: none"> • Check operation. • Adjust brake lever free play and replace brake shoes if necessary. 	√	√	√
3	* Rear brake	<ul style="list-style-type: none"> • Check operation. • Adjust brake pedal free play and replace brake shoes if necessary. 	√	√	√
4	* Wheels	<ul style="list-style-type: none"> • Check runout, spoke tightness and for damage. • Tighten spokes if necessary. 	√	√	√
5	* Tires	<ul style="list-style-type: none"> • Check tread depth and for damage. • Replace if necessary. • Check air pressure. • Correct if necessary. 		√	√
6	* Wheel bearings	<ul style="list-style-type: none"> • Check bearings for smooth operation. • Replace if necessary. 		√	√
7	* Swingarm pivot bearings	<ul style="list-style-type: none"> • Check bearing assemblies for looseness. • Moderately repack with lithium-soap-based grease. 		√	√

PERIODIC MAINTENANCE AND ADJUSTMENT

No.	ITEM	CHECKS AND MAINTENANCE JOBS	INITIAL	ODOMETER READINGS	
			1000 km (600 mi) or 1 month or 30 hours	3000 km (1800 mi) or 6 months or 90 hours	5000 km (3000 mi) or 12 months or 150 hours
8	Drive chain	<ul style="list-style-type: none"> • Check chain slack/alignment and condition. • Adjust and lubricate chain with Yamaha chain and cable lube thoroughly. 	Every ride		
9	* Steering bearings	<ul style="list-style-type: none"> • Check bearing assemblies for looseness. • Moderately repack with lithium-soap-based grease. 	√		√
10	* Chassis fasteners	<ul style="list-style-type: none"> • Check all chassis fitting and fasteners. • Correct if necessary. 	√	√	√
11	Brake lever pivot shaft	<ul style="list-style-type: none"> • Apply lithium-soap-based grease lightly. 		√	√
12	Brake pedal pivot shaft	<ul style="list-style-type: none"> • Apply lithium-soap-based grease lightly. 		√	√
13	Sidestand pivot	<ul style="list-style-type: none"> • Check operation. • Apply lithium-soap-based grease lightly. 	√		√
14	* Front fork	<ul style="list-style-type: none"> • Check operation and for oil leakage. • Replace if necessary. 		√	√
15	* Shock absorber assembly	<ul style="list-style-type: none"> • Check operation and for oil leakage. • Replace if necessary. 			√
16	* Control cables	<ul style="list-style-type: none"> • Apply Yamaha chain and cable lube or engine oil thoroughly. 	√	√	√
17	* Throttle grip	<ul style="list-style-type: none"> • Check operation. • Check throttle grip free play, and adjust if necessary. • Lubricate cable and grip housing. 	√	√	√

PERIODIC MAINTENANCE AND ADJUSTMENT

EAU40000

TIP _____
The air filter needs more frequent service if you are riding in unusually wet or dusty areas.

PERIODIC MAINTENANCE AND ADJUSTMENT

Removing and installing panels

EAU18771

The panels shown need to be removed to perform some of the maintenance jobs described in this chapter. Refer to this section each time a panel needs to be removed and installed.

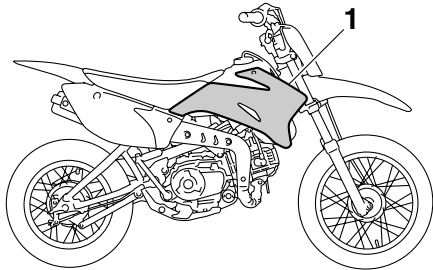

1. Panel A

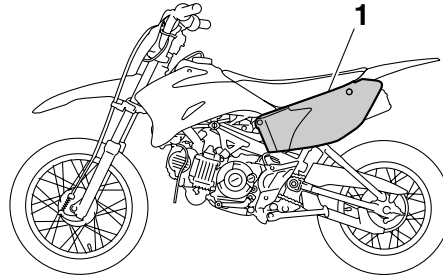

1. Panel B

Panel A

To remove the panel

1. Remove the seat. (See page 4-7.)
2. Remove the bolts and the quick fastener screws, and then take the panel off.

EAU41110

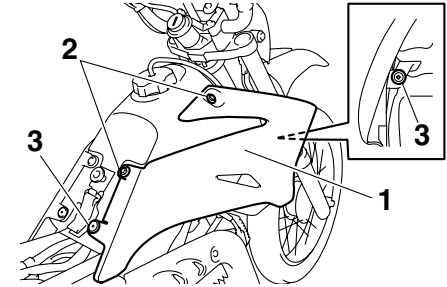

1. Panel A
2. Bolt
3. Quick fastener screw

To install the panel

1. Place the panel in the original position, and then install the bolts and the quick fastener screws.
2. Install the seat.

Panel B

EAU33020

To remove the panel

1. Remove the seat. (See page 4-7.)
2. Remove the bolt, and then pull the panel off as shown.

PERIODIC MAINTENANCE AND ADJUSTMENT

EAU19604

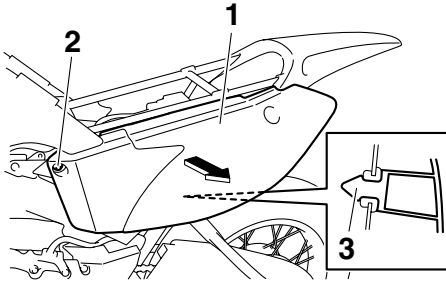

1. Panel B
2. Bolt
3. Projection

To install the panel

1. Place the panel in the original position, and then install the bolt.
2. Install the seat.

Checking the spark plug

The spark plug is an important engine component, which is easy to check. Since heat and deposits will cause any spark plug to slowly erode, the spark plug should be removed and checked in accordance with the periodic maintenance and lubrication chart. In addition, the condition of the spark plug can reveal the condition of the engine.

To remove the spark plug

1. Remove the spark plug cap.

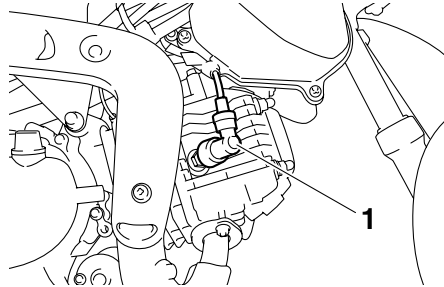

1. Spark plug cap

2. Remove the spark plug as shown, with the spark plug wrench included in the owner's tool kit.

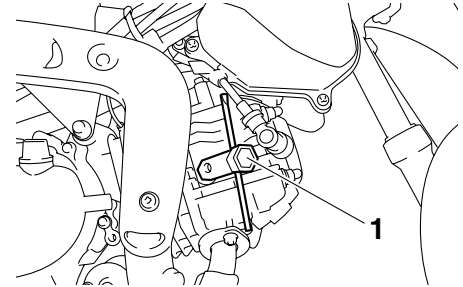

1. Spark plug wrench

To check the spark plug

1. Check that the porcelain insulator around the center electrode of the spark plug is a medium-to-light tan (the ideal color when the vehicle is ridden normally).

TIP

If the spark plug shows a distinctly different color, the engine could be operating improperly. Do not attempt to diagnose such problems yourself. Instead, have a Yamaha dealer check the vehicle.

PERIODIC MAINTENANCE AND ADJUSTMENT

EAU39845

2. Check the spark plug for electrode erosion and excessive carbon or other deposits, and replace it if necessary.

Specified spark plug:
NGK/CR6HSA

3. Measure the spark plug gap with a wire thickness gauge and, if necessary, adjust the gap to specification.

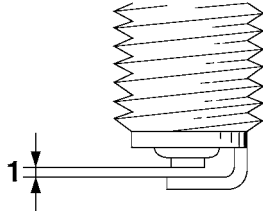

1. Spark plug gap

Spark plug gap:
0.6–0.7 mm (0.024–0.028 in)

To install the spark plug

1. Clean the surface of the spark plug gasket and its mating surface, and then wipe off any grime from the spark plug threads.
2. Install the spark plug with the spark plug wrench, and then tighten it to the specified torque.

Tightening torque:

Spark plug:
13 Nm (1.3 m·kgf, 9.4 ft·lbf)

TIP

If a torque wrench is not available when installing a spark plug, a good estimate of the correct torque is 1/4–1/2 turn past finger tight. However, the spark plug should be tightened to the specified torque as soon as possible.

3. Install the spark plug cap.

Engine oil

The engine oil level should be checked before each ride. In addition, the oil must be changed at the intervals specified in the periodic maintenance and lubrication chart.

To check the engine oil level

1. Place the motorcycle on a level surface and hold it in an upright position. A slight tilt to the side can result in a false reading.
2. Start the engine, warm it up for several minutes, and then turn it off.
3. Wait a few minutes until the oil settles, remove the engine oil filler cap, wipe the engine oil dipstick clean, insert it back into the oil filler hole (without screwing it in), and then remove it again to check the oil level.

TIP

The engine oil should be between the tip of the dipstick and the maximum level mark.

PERIODIC MAINTENANCE AND ADJUSTMENT

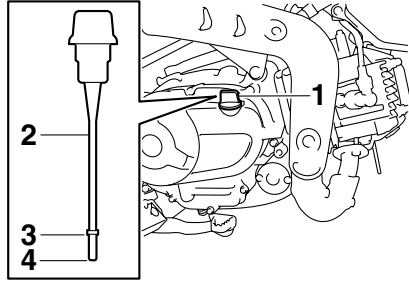

1. Engine oil filler cap
2. Engine oil dipstick
3. Maximum level mark
4. Tip of the engine oil dipstick

4. If the engine oil is not between the tip of the dipstick and the maximum level mark, add sufficient oil of the recommended type to raise it to the correct level.
5. Insert the dipstick into the oil filler hole, and then tighten the oil filler cap.

To change the engine oil

1. Start the engine, warm it up for several minutes, and then turn it off.
2. Place an oil pan under the engine to collect the used oil.

3. Remove the engine oil filler cap, the engine oil drain bolt and its gasket to drain the oil from the crankcase.

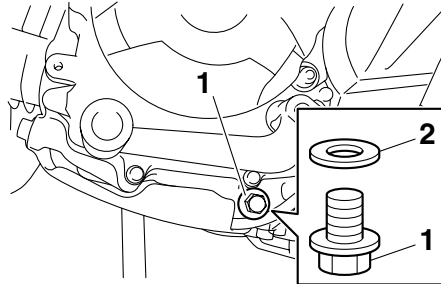

1. Engine oil drain bolt
2. Gasket

4. Install a new gasket and the drain bolt, and then tighten the drain bolt to the specified torque.

Tightening torque:

Engine oil drain bolt:
20 Nm (2.0 m·kgf, 14 ft·lbf)

5. Refill with the specified amount of the recommended engine oil, and then install and tighten the oil filler cap.

Recommended engine oil:

See page 9-1.

Oil change quantity:

0.80 L (0.85 US qt, 0.70 Imp.qt)

ECA11620

NOTICE

- In order to prevent clutch slippage (since the engine oil also lubricates the clutch), do not mix any chemical additives. Do not use oils with a diesel specification of “CD” or oils of a higher quality than specified. In addition, do not use oils labeled “ENERGY CONSERVING II” or higher.
- Make sure that no foreign material enters the crankcase.

6. Start the engine, and then let it idle for several minutes while checking it for oil leakage. If oil is leaking, immediately turn the engine off and check for the cause.
7. Turn the engine off, and then check the oil level and correct it if necessary.

PERIODIC MAINTENANCE AND ADJUSTMENT

EAU41636

Cleaning the air filter element

The air filter element should be cleaned or replaced at the intervals specified in the periodic maintenance and lubrication chart. Clean or, if necessary, replace the air filter element more frequently if you are riding in unusually wet or dusty areas.

To clean the air filter element

1. Remove panel A. (See page 7-7.)
2. Remove the air filter case cover by removing the screws.

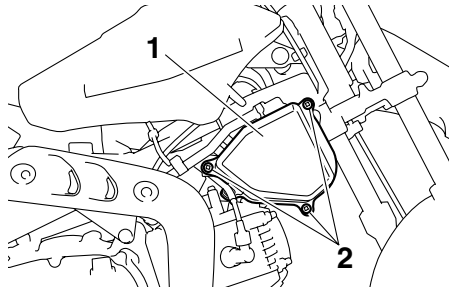

1. Air filter case cover
2. Screw

3. Pull the sponge material and the mesh out.

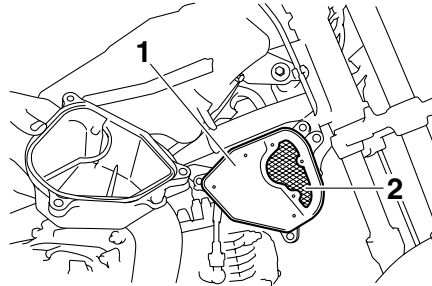

1. Sponge material
2. Air filter mesh

4. Clean the mesh with solvent, and then wipe the solvent off.
5. Clean the sponge material with solvent, and then squeeze the remaining solvent out. **WARNING!** Use only a dedicated parts cleaning solvent. To avoid the risk of fire or explosion, do not use gasoline or solvents with a low flash point. [EWA10431] **NOTICE:** To avoid damaging the foam material, handle it gently and do not twist or wring it. [ECA10511]

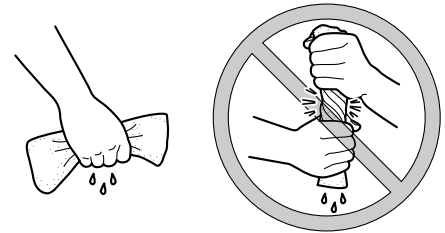

6. Apply oil of the recommended type to the entire surface of the sponge material, and then squeeze the excess oil out.

TIP

The sponge material should be wet but not dripping.

Recommended oil:

Yamaha foam air filter oil or other quality foam air filter oil

7. Insert the mesh and the sponge material into the air filter case. **NOTICE:** Make sure that the mesh and the sponge material are properly seated in the air filter case. The engine should never be operated without the

PERIODIC MAINTENANCE AND ADJUSTMENT

mesh and the sponge material installed, otherwise the piston(s) and/or cylinder(s) may become excessively worn.

[ECA15572]

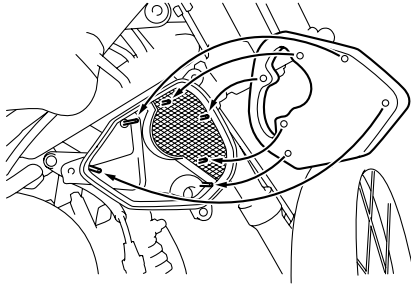

8. Install the air filter case cover by installing the screws.

TIP

Make sure that the spark plug lead is inserted into the guide as shown.

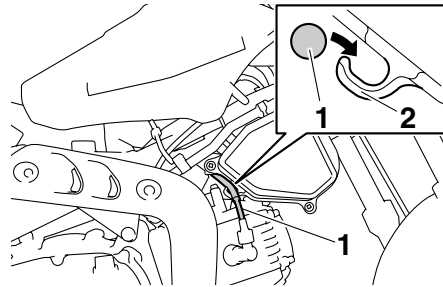

1. Spark plug lead
2. Guide

9. Install the panel.

To clean the air filter check hose

1. Check the hoses at the bottom of the air filter case for accumulated dirt or water.

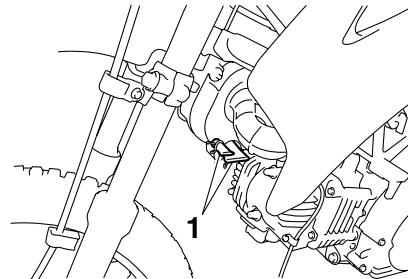

1. Air filter check hose

2. If dirt or water is visible, remove the hoses, clean them, and then reinstall them.

PERIODIC MAINTENANCE AND ADJUSTMENT

EAU40421

Cleaning the spark arrester

The spark arrester should be cleaned at the intervals specified in the periodic maintenance and lubrication chart.

EWA10980

WARNING

- Always let the exhaust system cool prior to touching exhaust components.
- Do not start the engine when cleaning the exhaust system.

TIP

Make sure to select a well-ventilated area free of combustible materials to clean the spark arrester.

7

1. Remove the tailpipe by removing the bolts, and then pulling it out of the muffler.

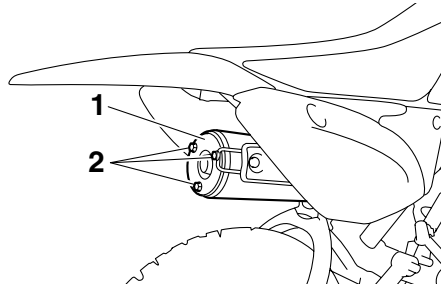

1. Tailpipe
2. Tailpipe bolt

2. Tap the tailpipe lightly, and then use a wire brush to remove any carbon deposits from the spark arrester portion of the tailpipe and inside of the tailpipe housing.

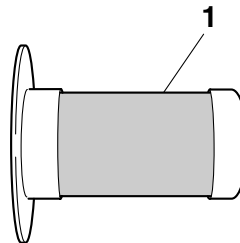

1. Spark arrester

3. Insert the tailpipe into the muffler, and then install and tighten the bolts to the specified torque.

Tightening torque:

Tailpipe bolt:
10 Nm (1.0 m·kgf, 7.2 ft·lbf)

TIP

Make sure to align the bolt holes when inserting the tailpipe.

PERIODIC MAINTENANCE AND ADJUSTMENT

Adjusting the carburetor

EAU39930

The carburetor is an important part of the engine and requires very sophisticated adjustment. Therefore, most carburetor adjustments should be left to a Yamaha dealer, who has the necessary professional knowledge and experience. The adjustment described in the following section, however, may be serviced by the owner as part of routine maintenance.

ECA10550

NOTICE

The carburetor has been set and extensively tested at the Yamaha factory. Changing these settings without sufficient technical knowledge may result in poor performance of or damage to the engine.

Adjusting the engine idling speed

EAU21362

The engine idling speed must be checked and, if necessary, adjusted as follows at the intervals specified in the periodic maintenance and lubrication chart.

TIP

A diagnostic tachometer is needed to make this adjustment.

1. Attach the tachometer to the spark plug lead.
2. Start the engine and warm it up for several minutes at 1000–2000 r/min while occasionally revving it to 4000–5000 r/min.

TIP

The engine is warm when it quickly responds to the throttle.

3. Check the engine idling speed and, if necessary, adjust it to specification by turning the throttle stop screw. To increase the engine idling speed, turn the screw in di-

rection (a). To decrease the engine idling speed, turn the screw in direction (b).

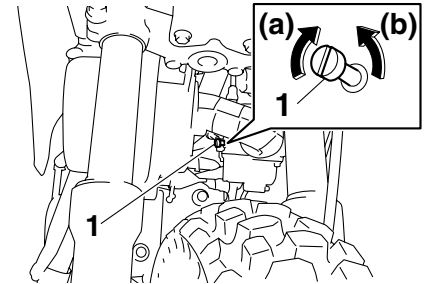

1. Throttle stop screw

Engine idling speed:
1600–1800 r/min

TIP

If the specified idling speed cannot be obtained as described above, have a Yamaha dealer make the adjustment.

PERIODIC MAINTENANCE AND ADJUSTMENT

Checking the throttle grip free play

EAU21384

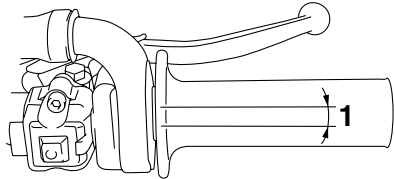

1. Throttle grip free play

The throttle grip free play should measure 4.0–6.0 mm (0.16–0.24 in) at the inner edge of the throttle grip. Periodically check the throttle grip free play and, if necessary, have a Yamaha dealer adjust it.

Valve clearance

EAU21401

The valve clearance changes with use, resulting in improper air-fuel mixture and/or engine noise. To prevent this from occurring, the valve clearance must be adjusted by a Yamaha dealer at the intervals specified in the periodic maintenance and lubrication chart.

Tires

EAU39824

To maximize the performance, durability, and safe operation of your motorcycle, note the following points regarding the specified tires.

Tire air pressure

The tire air pressure should be checked and, if necessary, adjusted before each ride.

EWA15370

⚠ WARNING

Operation of this vehicle with improper tire pressure may cause severe injury or death from loss of control.

The tire air pressure must be checked and adjusted on cold tires (i.e., when the temperature of the tires equals the ambient temperature).

Standard tire air pressure:

Front:

100 kPa (1.00 kgf/cm², 15 psi)

Rear:

100 kPa (1.00 kgf/cm², 15 psi)

PERIODIC MAINTENANCE AND ADJUSTMENT

Tire inspection

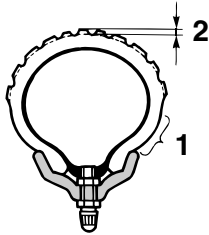

1. Tire sidewall
2. Tire tread depth

The tires must be checked before each ride. If the center tread depth reaches the specified limit, if the tire has a nail or glass fragments in it, or if the sidewall is cracked, have a Yamaha dealer replace the tire immediately.

Minimum tire tread depth (front and rear):
4.0 mm (0.16 in)

Tire information

This motorcycle is equipped with spoke wheels and tube tires.

EWA10461

! WARNING

The front and rear tires should be of the same make and design, otherwise the handling characteristics of the vehicle may be different, which could lead to an accident.

After extensive tests, only the tires listed below have been approved for this model by Yamaha Motor Co., Ltd.

Front tire:

Size:
2.50-14 4PR
Manufacturer/model:
CHEN SHIN/C-803-2

Rear tire:

Size:
3.00-12 4PR
Manufacturer/model:
CHEN SHIN/C-803-2

EWA15541

! WARNING

- Have a Yamaha dealer replace excessively worn tires. Operating the motorcycle with excessively worn tires decreases riding stability and can lead to loss of control.

- The replacement of all wheel- and brake-related parts, including the tires, should be left to a Yamaha dealer, who has the necessary professional knowledge and experience.
- It is not recommended to patch a punctured tube. If unavoidable, however, patch the tube very carefully and replace it as soon as possible with a high-quality product.
- Ride conservatively after changing a tire since the tire must seat itself on the rim properly. Failure to allow proper seating may cause tire failure, which may result in damage to the motorcycle and injury to the rider.

PERIODIC MAINTENANCE AND ADJUSTMENT

Spoke wheels

EAU21943

EWA10610

WARNING

The wheels on this model are not designed for use with tubeless tires. Do not attempt to use tubeless tires on this model.

To maximize the performance, durability, and safe operation of your motorcycle, note the following points regarding the specified wheels.

- The wheel rims should be checked for cracks, bends, warpage or other damage, and the spokes for looseness or damage before each ride. If any damage is found, have a Yamaha dealer replace the wheel. Do not attempt even the smallest repair to the wheel. A deformed or cracked wheel must be replaced.
- The wheel should be balanced whenever either the tire or wheel has been changed or replaced. An unbalanced wheel can result in poor performance, adverse handling characteristics, and a shortened tire life.

EAU44663

Adjusting the clutch free play

The clutch free play must be checked and, if necessary, adjusted as follows at the intervals specified in the periodic maintenance and lubrication chart.

1. Loosen the locknut.
2. Slowly turn the clutch adjusting screw in direction (a) until resistance is felt, and then turn it 1/8 turn in direction (b).

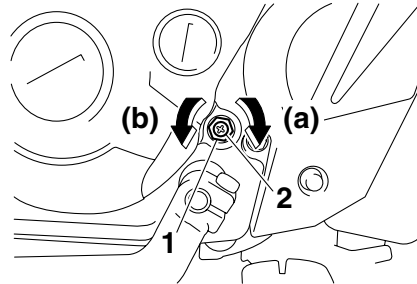

1. Locknut
2. Clutch adjusting screw
3. Tighten the locknut to the specified torque.

Tightening torque:

Locknut:

8 Nm (0.8 m·kgf, 5.8 ft·lbf)

TIP

When tightening the locknut, hold the clutch adjusting screw with a screwdriver so that it does not turn together with the locknut.

PERIODIC MAINTENANCE AND ADJUSTMENT

Adjusting the brake lever free play

EAU44884

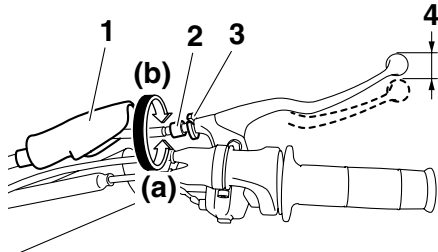

1. Rubber cover
2. Brake lever free play adjusting bolt
3. Locknut
4. Brake lever free play

The brake lever free play should measure 10.0–20.0 mm (0.39–0.79 in) as shown. Periodically check the brake lever free play and, if necessary, adjust it as follows.

1. Slide the rubber cover back.
2. Loosen the locknut at the brake lever.
3. To increase the brake lever free play, turn the brake lever free play adjusting bolt in direction (a). To

decrease the brake lever free play, turn the adjusting bolt in direction (b).

TIP

Skip steps 4–7 if the specified brake lever free play could be obtained as described above.

4. Fully turn the adjusting bolt at the brake lever in direction (a) to loosen the brake cable.
5. Loosen the locknut at the brake shoe plate.
6. To increase the brake lever free play, turn the adjusting bolt at the brake shoe plate in direction (a). To decrease the brake lever free play, turn the adjusting bolt in direction (b).

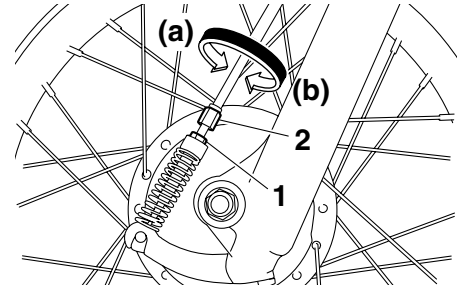

1. Locknut
2. Brake lever free play adjusting bolt
7. Tighten the locknut at the brake shoe plate.
8. Tighten the locknut at the brake lever, and then slide the rubber cover to its original position.

PERIODIC MAINTENANCE AND ADJUSTMENT

Adjusting the brake pedal free play

EAU44671

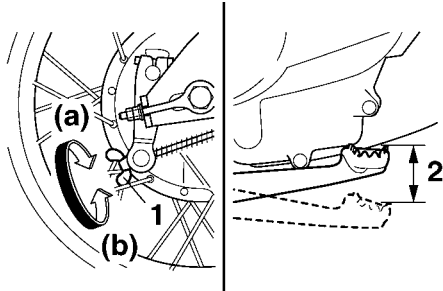

1. Brake pedal free play adjusting nut
2. Brake pedal free play

The brake pedal free play should measure 10.0–20.0 mm (0.39–0.79 in) at the brake pedal end as shown. Periodically check the brake pedal free play and, if necessary, adjust it as follows.

To increase the brake pedal free play, turn the brake pedal free play adjusting nut at the brake rod in direction (a). To decrease the brake pedal free play, turn the adjusting nut in direction (b).

EWA14820

WARNING

- After adjusting the drive chain slack or removing and installing the rear wheel, always check the brake pedal free play.
- If proper adjustment cannot be obtained as described, have a Yamaha dealer make this adjustment.

EAU44820

Checking the shift pedal

The operation of the shift pedal should be checked before each ride. If operation is not smooth, have a Yamaha dealer check the vehicle.

PERIODIC MAINTENANCE AND ADJUSTMENT

Checking the front and rear brake shoes

EAU22361

Front

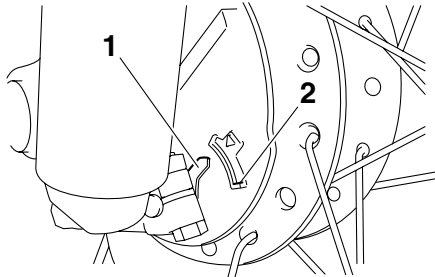

1. Brake shoe wear indicator
2. Brake shoe wear limit line

Rear

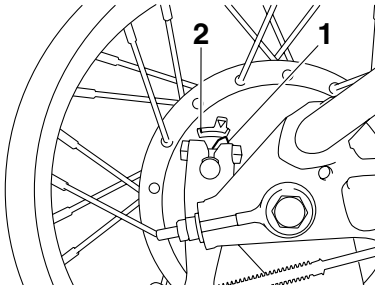

1. Brake shoe wear indicator
2. Brake shoe wear limit line

The front and rear brake shoes must be checked for wear at the intervals specified in the periodic maintenance and lubrication chart. Each brake is provided with a wear indicator, which allows you to check the brake shoe wear without having to disassemble the brake. To check the brake shoe wear, check the position of the wear indicator while applying the brake. If a brake shoe has worn to the point that the wear indicator reaches the wear limit line, have a Yamaha dealer replace the brake shoes as a set.

Drive chain slack

EAU22760

The drive chain slack should be checked before each ride and adjusted if necessary.

EAU22774

To check the drive chain slack

1. Place the motorcycle on the side-stand.

TIP

When checking and adjusting the drive chain slack, there should be no weight on the motorcycle.

2. Shift the transmission into the neutral position.
3. Measure the drive chain slack as shown.

Drive chain slack:
40.0–56.0 mm (1.57–2.20 in)

PERIODIC MAINTENANCE AND ADJUSTMENT

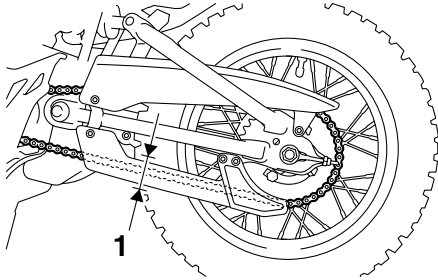

1. Drive chain slack

4. If the drive chain slack is incorrect, adjust it as follows.

To adjust the drive chain slack

EAU40114

Consult a Yamaha dealer before adjusting the drive chain slack.

1. Loosen the brake pedal free play adjusting nut, axle nut, and locknut at each end of the swingarm.

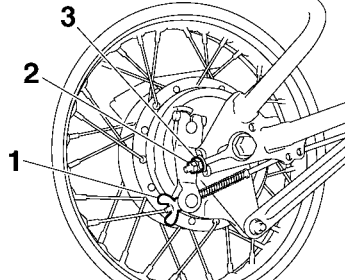

1. Brake pedal free play adjusting nut
2. Locknut
3. Drive chain slack adjusting nut

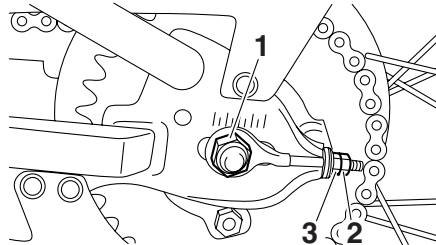

1. Axle nut
2. Locknut
3. Drive chain slack adjusting nut

2. To tighten the drive chain, turn the drive chain slack adjusting nut at each end of the swingarm in direc-

tion (a). To loosen the drive chain, turn the adjusting nut at each end of the swingarm in direction (b), and then push the rear wheel forward. **NOTICE: Improper drive chain slack will overload the engine as well as other vital parts of the motorcycle and can lead to chain slippage or breakage. To prevent this from occurring, keep the drive chain slack within the specified limits.** [ECA10571]

TIP

Using the alignment marks on each side of the swingarm, make sure that both drive chain pullers are in the same position for proper wheel alignment.

PERIODIC MAINTENANCE AND ADJUSTMENT

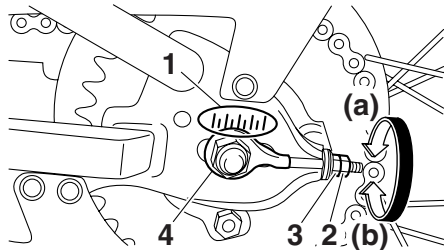

1. Alignment marks
 2. Locknut
 3. Drive chain slack adjusting nut
 4. Drive chain puller
3. Tighten the axle nut and both locknuts to the specified torques.

Tightening torques:

Axle nut:

60 Nm (6.0 m·kgf, 43 ft·lbf)

Locknut:

7 Nm (0.7 m·kgf, 5.1 ft·lbf)

4. Adjust the brake pedal free play. (See page 7-19.)
5. Make sure that the drive chain pullers are in the same position, the drive chain slack is correct, and the drive chain moves smoothly.

Cleaning and lubricating the drive chain

EAU23016

The drive chain must be cleaned and lubricated at the intervals specified in the periodic maintenance and lubrication chart, otherwise it will quickly wear out, especially when riding in dusty or wet areas. Service the drive chain as follows.

NOTICE

ECA10583

The drive chain must be lubricated after washing the motorcycle, riding in the rain or riding in wet areas.

1. Remove all dirt and mud from the drive chain with a brush or cloth.

TIP

For a thorough cleaning, have a Yamaha dealer remove the drive chain and soak it in solvent.

2. Spray Yamaha Chain and Cable Lube or a high-quality spray-type drive chain lubricant on the entire chain, making sure that all side plates and rollers have been sufficiently oiled.

Checking and lubricating the cables

EAU23095

The operation of all control cables and the condition of the cables should be checked before each ride, and the cables and cable ends should be lubricated if necessary. If a cable is damaged or does not move smoothly, have a Yamaha dealer check or replace it.

WARNING! Damage to the outer housing of cables may result in internal rusting and cause interference with cable movement. Replace damaged cables as soon as possible to prevent unsafe conditions.

[EWA10711]

Recommended lubricant:

Yamaha Chain and Cable Lube or engine oil

PERIODIC MAINTENANCE AND ADJUSTMENT

Checking and lubricating the throttle grip and cable

EAU23114

The operation of the throttle grip should be checked before each ride. In addition, the cable should be lubricated by a Yamaha dealer at the intervals specified in the periodic maintenance chart. The throttle cable is equipped with a rubber cover. Make sure that the cover is securely installed. Even though the cover is installed correctly, it does not completely protect the cable from water entry. Therefore, use care not to pour water directly onto the cover or cable when washing the vehicle. If the cable or cover becomes dirty, wipe clean with a moist cloth.

Checking and lubricating the brake lever

EAU43622

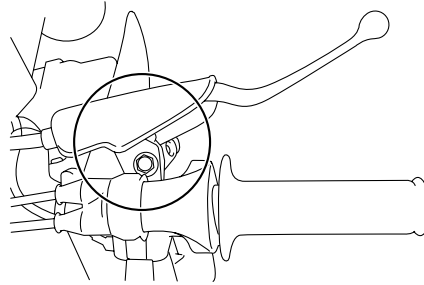

The operation of the brake lever should be checked before each ride, and the lever pivot should be lubricated if necessary.

Recommended lubricant:
Lithium-soap-based grease

Checking and lubricating the brake pedal

EAU23182

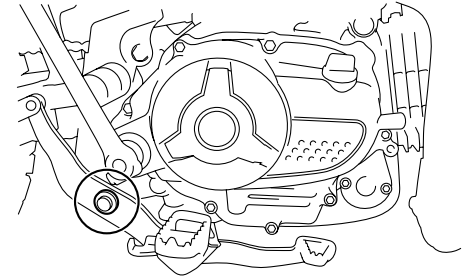

The operation of the brake pedal should be checked before each ride, and the pedal pivot should be lubricated if necessary.

Recommended lubricant:
Lithium-soap-based grease

PERIODIC MAINTENANCE AND ADJUSTMENT

Checking and lubricating the sidestand

EAU23202

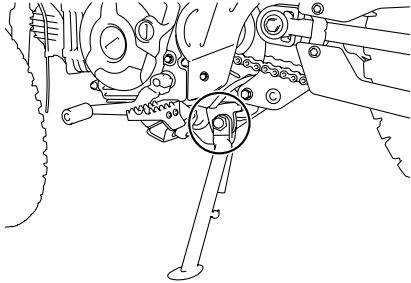

The operation of the sidestand should be checked before each ride, and the sidestand pivot and metal-to-metal contact surfaces should be lubricated if necessary.

EWA10731

WARNING

If the sidestand does not move up and down smoothly, have a Yamaha dealer check or repair it. Otherwise, the sidestand could contact the ground and distract the operator, resulting in a possible loss of control.

Recommended lubricant:
Lithium-soap-based grease

Lubricating the swingarm pivots

EAUM1652

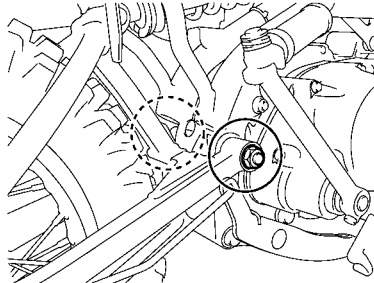

The swingarm pivots must be lubricated by a Yamaha dealer at the intervals specified in the periodic maintenance and lubrication chart.

Recommended lubricant:
Lithium-soap-based grease

Checking the front fork

EAU23272

The condition and operation of the front fork must be checked as follows at the intervals specified in the periodic maintenance and lubrication chart.

To check the condition

Check the inner tubes for scratches, damage and excessive oil leakage.

To check the operation

1. Place the vehicle on a level surface and hold it in an upright position. **WARNING! To avoid injury, securely support the vehicle so there is no danger of it falling over.** ^[EWA10751]
2. While applying the front brake, push down hard on the handlebars several times to check if the front fork compresses and rebounds smoothly.

PERIODIC MAINTENANCE AND ADJUSTMENT

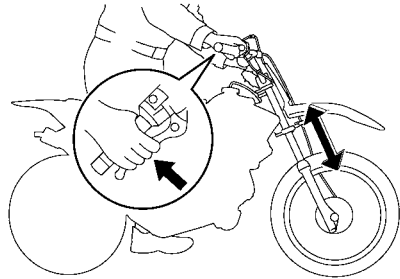

ECA10590

NOTICE

If any damage is found or the front fork does not operate smoothly, have a Yamaha dealer check or repair it.

Checking the steering

EAU23283

Worn or loose steering bearings may cause danger. Therefore, the operation of the steering must be checked as follows at the intervals specified in the periodic maintenance and lubrication chart.

1. Place a stand under the engine to raise the front wheel off the ground. (See page 7-28 for more information.) **WARNING! To avoid injury, securely support the vehicle so there is no danger of it falling over.** [EWA10751]
2. Hold the lower ends of the front fork legs and try to move them forward and backward. If any free play can be felt, have a Yamaha dealer check or repair the steering.

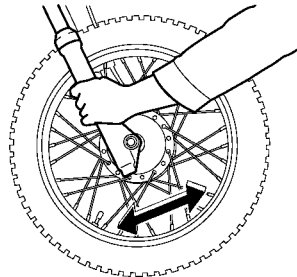

7-25

Checking the wheel bearings

EAU23291

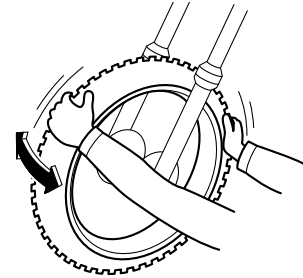

The front and rear wheel bearings must be checked at the intervals specified in the periodic maintenance and lubrication chart. If there is play in the wheel hub or if the wheel does not turn smoothly, have a Yamaha dealer check the wheel bearings.

PERIODIC MAINTENANCE AND ADJUSTMENT

Battery

EAU23396

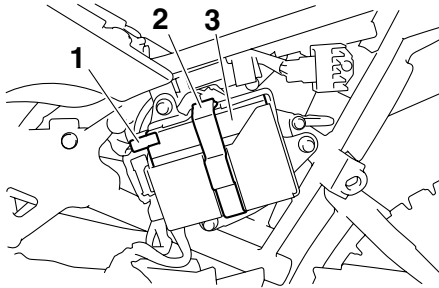

1. Battery coupler
2. Battery band
3. Battery

The battery is located behind panel B. (See page 7-7.)

This model is equipped with a VRLA (Valve Regulated Lead Acid) battery. There is no need to check the electrolyte or to add distilled water. However, the battery coupler needs to be checked and, if necessary, securely fastened.

EWA10760

WARNING

- **Electrolyte is poisonous and dangerous since it contains sulfuric acid, which causes severe**

burns. Avoid any contact with skin, eyes or clothing and always shield your eyes when working near batteries. In case of contact, administer the following **FIRST AID**.

- **EXTERNAL:** Flush with plenty of water.
- **INTERNAL:** Drink large quantities of water or milk and immediately call a physician.
- **EYES:** Flush with water for 15 minutes and seek prompt medical attention.
- **Batteries produce explosive hydrogen gas. Therefore, keep sparks, flames, cigarettes, etc., away from the battery and provide sufficient ventilation when charging it in an enclosed space.**
- **KEEP THIS AND ALL BATTERIES OUT OF THE REACH OF CHILDREN.**

To charge the battery

Have a Yamaha dealer charge the battery as soon as possible if it seems to have discharged. Keep in mind that the

battery tends to discharge more quickly if the vehicle is equipped with optional electrical accessories.

ECA16521

NOTICE

To charge a VRLA (Valve Regulated Lead Acid) battery, a special (constant-voltage) battery charger is required. Using a conventional battery charger will damage the battery.

To store the battery

1. If the model will not be used for more than one month, remove the battery, fully charge it, and then place it in a cool, dry place. **NOTICE: When removing the battery, be sure the key is turned to "OFF" before disconnecting the coupler.** [ECA16322]
2. If the battery will be stored for more than two months, check it at least once a month and fully charge it if necessary.
3. Fully charge the battery before installation. **NOTICE: When installing the battery, be sure the key is turned to "OFF" before connecting the coupler.** [ECA16930]

PERIODIC MAINTENANCE AND ADJUSTMENT

ECA16530

EAU50430

NOTICE

Always keep the battery charged. Storing a discharged battery can cause permanent battery damage.

Replacing the fuse

The fuse is located inside the battery coupler. (See page 7-26.)

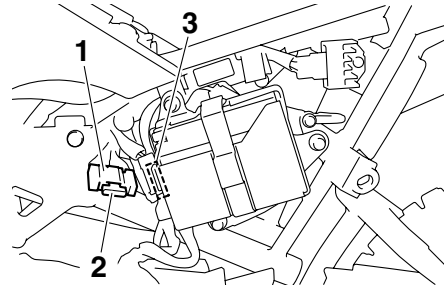

1. Battery coupler
2. Fuse
3. Spare fuse

If the fuse is blown, replace it as follows.

1. Turn the key to “OFF” and turn off all electrical circuits.
2. Disconnect the battery coupler.
3. Remove the blown fuse, and then install a new fuse of the specified amperage. **WARNING! Do not use a fuse of a higher amperage rating than recommended to**

avoid causing extensive damage to the electrical system and possibly a fire. [EWA15131]

Specified fuse:

10.0 A

4. Connect the battery coupler.
5. Turn the key to “ON”.
6. If the fuse immediately blows again, have a Yamaha dealer check the electrical system.

PERIODIC MAINTENANCE AND ADJUSTMENT

Supporting the motorcycle

EAU24350

Since this model is not equipped with a centerstand, follow these precautions when removing the front and rear wheel or performing other maintenance requiring the motorcycle to stand upright. Check that the motorcycle is in a stable and level position before starting any maintenance. A strong wooden box can be placed under the engine for added stability.

To service the front wheel

1. Stabilize the rear of the motorcycle by using a motorcycle stand or, if an additional motorcycle stand is not available, by placing a jack under the frame in front of the rear wheel.
2. Raise the front wheel off the ground by using a motorcycle stand.

To service the rear wheel

Raise the rear wheel off the ground by using a motorcycle stand or, if a motorcycle stand is not available, by placing

a jack either under each side of the frame in front of the rear wheel or under each side of the swingarm.

Front wheel

EAU24360

To remove the front wheel

EAU41815

EWA10821



To avoid injury, securely support the vehicle so there is no danger of it falling over.

1. Slide the rubber cover back at the brake lever.
2. Loosen the locknut, and then turn the brake lever free play adjusting bolt fully in direction (a).

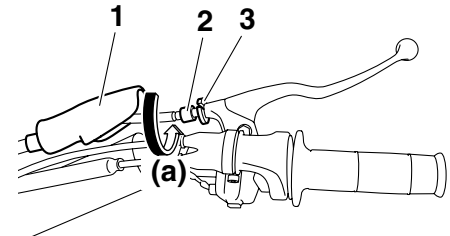

1. Rubber cover
2. Brake lever free play adjusting bolt
3. Locknut

3. Loosen the axle nut.

PERIODIC MAINTENANCE AND ADJUSTMENT

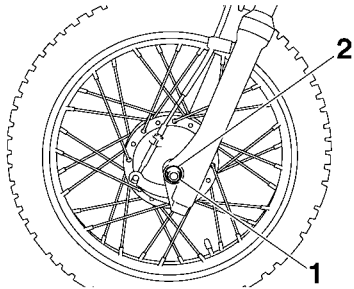

1. Axle nut
2. Washer

4. Lift the front wheel off the ground according to the procedure in the previous section "Supporting the motorcycle".
5. Remove the axle nut and washer.
6. Pull the wheel axle out.

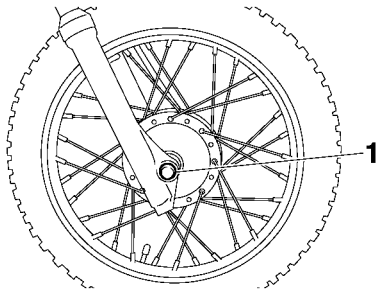

1. Wheel axle

7. Remove the brake shoe assembly from the wheel hub by pulling it out.

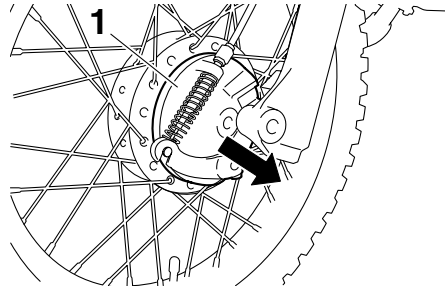

1. Brake shoe assembly

8. Remove the wheel.

To install the front wheel

EAU41693

1. Install the brake shoe assembly into the wheel hub.
2. Lift the wheel up between the fork legs.

TIP

Make sure that the slot in the brake shoe plate fits over the retainer on the fork leg.

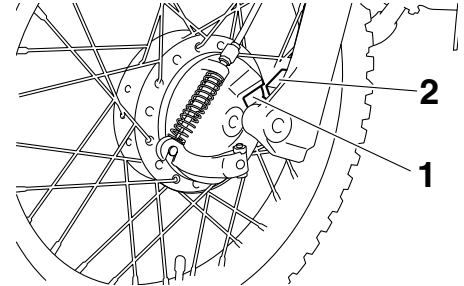

1. Slot
2. Retainer

3. Insert the wheel axle from the right-hand side, and then install the washer and the axle nut.
4. Lower the front wheel so that it is on the ground, and then put the sidestand down.
5. Tighten the axle nut to the specified torque.

Tightening torque:

Axle nut:
35 Nm (3.5 m·kgf, 25 ft·lbf)

6. Adjust the brake lever free play. (See page 7-18.)

PERIODIC MAINTENANCE AND ADJUSTMENT

7. While applying the front brake, push down hard on the handlebar several times to check for proper fork operation.

Rear wheel

EAU25080

EAU41645

EWA10821

To remove the rear wheel

WARNING

To avoid injury, securely support the vehicle so there is no danger of it falling over.

1. Disconnect the brake torque rod from the brake shoe plate by removing the cotter pin, the nut and the bolt.

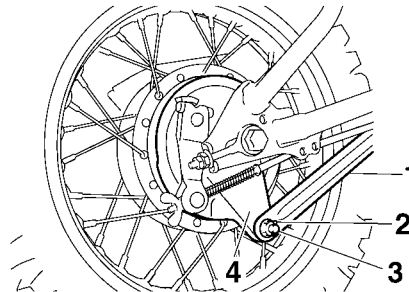

1. Brake torque rod
2. Cotter pin
3. Brake torque rod bolt and nut
4. Brake shoe plate

2. Remove the brake pedal free play adjusting nut, and then disconnect the brake rod at the brake camshaft lever.

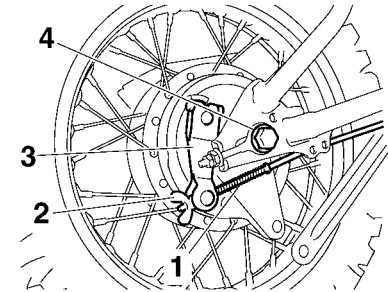

1. Brake rod
2. Brake pedal free play adjusting nut
3. Brake camshaft lever
4. Wheel axle

3. Fully loosen the locknut and the drive chain slack adjusting nut on both ends of the swingarm.

PERIODIC MAINTENANCE AND ADJUSTMENT

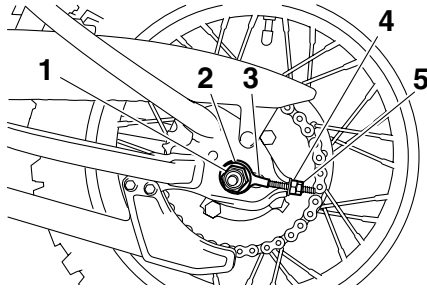

1. Axle nut
2. Washer
3. Drive chain puller
4. Drive chain slack adjusting nut
5. Locknut

4. Loosen the axle nut.
5. Lift the rear wheel off the ground according to the procedure on page 7-28.
6. Remove the axle nut, washer and the drive chain puller at the left-hand side, then pull the wheel axle out together with the drive chain puller from the right-hand side.
7. Push the wheel forward, and then remove the drive chain from the rear sprocket.

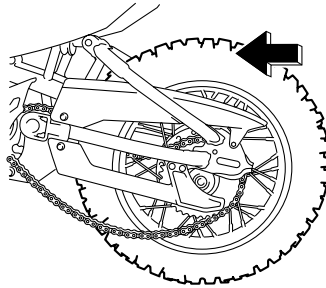

TIP

The drive chain does not need to be disassembled in order to remove and install the wheel.

8. Remove the wheel.

To install the rear wheel

1. Install the drive chain onto the rear sprocket.
2. Lift the rear wheel off the ground, and then install the drive chain puller and the wheel by inserting the wheel axle from the right-hand side.
3. Install the drive chain puller, washer and axle nut.

4. Lower the rear wheel so that it is on the ground, and then put the sidestand down.
5. Install the brake rod onto the brake camshaft lever, and then install the brake pedal free play adjusting nut onto the brake rod.
6. Connect the brake torque rod to the brake shoe plate by installing the bolt and nut, and then tighten the nut to the specified torque.

Tightening torque:

Brake torque rod nut:
26 Nm (2.6 m·kgf, 19 ft·lbf)

7. Insert a new cotter pin.
8. Adjust the drive chain slack. (See page 7-20.)
9. Tighten the axle nut to the specified torque.

Tightening torque:

Axle nut:
60 Nm (6.0 m·kgf, 43 ft·lbf)

10. Adjust the brake pedal free play. (See page 7-19.)

EAU25851

Troubleshooting

Although Yamaha motorcycles receive a thorough inspection before shipment from the factory, trouble may occur during operation. Any problem in the fuel, compression, or ignition systems, for example, can cause poor starting and loss of power.

The following troubleshooting chart represents a quick and easy procedure for checking these vital systems yourself. However, should your motorcycle require any repair, take it to a Yamaha dealer, whose skilled technicians have the necessary tools, experience, and know-how to service the motorcycle properly.

Use only genuine Yamaha replacement parts. Imitation parts may look like Yamaha parts, but they are often inferior, have a shorter service life and can lead to expensive repair bills.

EWA15141



When checking the fuel system, do not smoke, and make sure there are no open flames or sparks in the area, including pilot lights from water

heaters or furnaces. Gasoline or gasoline vapors can ignite or explode, causing severe injury or property damage.

PERIODIC MAINTENANCE AND ADJUSTMENT

EAU25903

Troubleshooting chart

1. Fuel

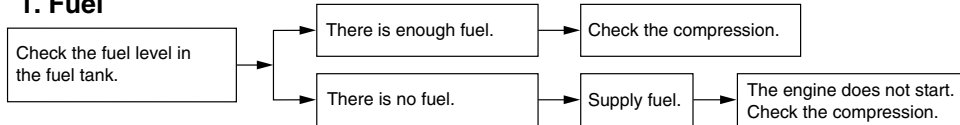

2. Compression

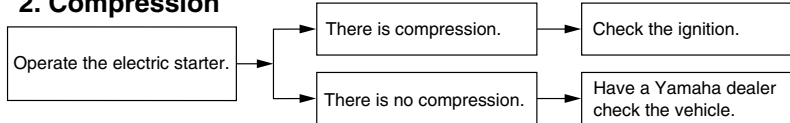

3. Ignition

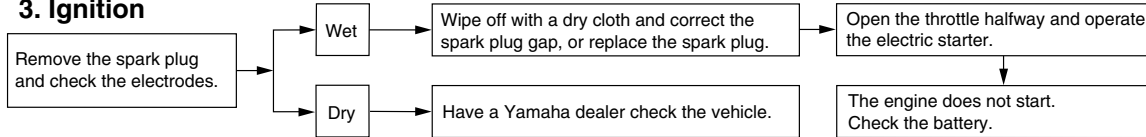

4. Battery

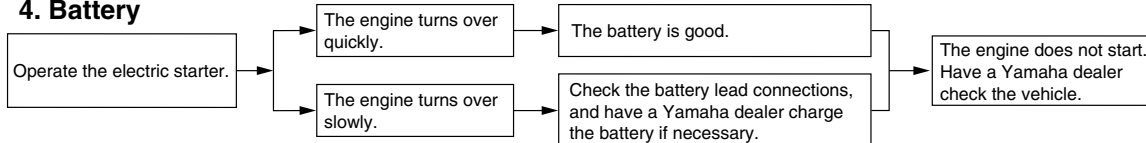

7

Matte color caution

EAU37833

EAU40465

NOTICE

Some models are equipped with matte colored finished parts. Be sure to consult a Yamaha dealer for advice on what products to use before cleaning the vehicle. Using a brush, harsh chemical products or cleaning compounds when cleaning these parts will scratch or damage their surface. Wax also should not be applied to any matte colored finished parts.

ECA15192

Care

While the open design of a motorcycle reveals the attractiveness of the technology, it also makes it more vulnerable. Rust and corrosion can develop even if high-quality components are used. A rusty exhaust pipe may go unnoticed on a car, however, it detracts from the overall appearance of a motorcycle. Frequent and proper care does not only comply with the terms of the warranty, but it will also keep your motorcycle looking good, extend its life and optimize its performance.

Before cleaning

1. Cover the muffler outlet with a plastic bag after the engine has cooled down.
2. Make sure that all caps and covers as well as all electrical couplers and connectors, including the spark plug cap, are tightly installed.
3. Remove extremely stubborn dirt, like oil burnt onto the crankcase, with a degreasing agent and a brush, but never apply such prod-

ucts onto seals, gaskets, sprockets, the drive chain and wheel axles. Always rinse the dirt and degreaser off with water.

Cleaning

ECA10772

NOTICE

- Avoid using strong acidic wheel cleaners, especially on spoked wheels. If such products are used on hard-to-remove dirt, do not leave the cleaner on the affected area any longer than instructed. Also, thoroughly rinse the area off with water, immediately dry it, and then apply a corrosion protection spray.
- Improper cleaning can damage plastic parts (such as cowlings, panels, windshields, headlight lenses, meter lenses, etc.) and the mufflers. Use only a soft, clean cloth or sponge with water to clean plastic. However, if the plastic parts cannot be thoroughly cleaned with water, diluted mild detergent with water may be used. Be sure to rinse

MOTORCYCLE CARE AND STORAGE

off any detergent residue using plenty of water, as it is harmful to plastic parts.

- Do not use any harsh chemical products on plastic parts. Be sure to avoid using cloths or sponges which have been in contact with strong or abrasive cleaning products, solvent or thinner, fuel (gasoline), rust removers or inhibitors, brake fluid, antifreeze or electrolyte.
- Do not use high-pressure washers or steam-jet cleaners since they cause water seepage and deterioration in the following areas: seals (of wheel and swing-arm bearings, fork and brakes), electric components (couplers, connectors, instruments, switches and lights), breather hoses and vents.
- For motorcycles equipped with a windshield: Do not use strong cleaners or hard sponges as they will cause dulling or scratching. Some cleaning compounds for plastic may leave scratches on the windshield.

Test the product on a small hidden part of the windshield to make sure that it does not leave any marks. If the windshield is scratched, use a quality plastic polishing compound after washing.

After normal use

Remove dirt with warm water, a mild detergent, and a soft, clean sponge, and then rinse thoroughly with clean water. Use a toothbrush or bottlebrush for hard-to-reach areas. Stubborn dirt and insects will come off more easily if the area is covered with a wet cloth for a few minutes before cleaning.

After riding in the rain or near the sea

Since sea salt is extremely corrosive, carry out the following steps after each ride in the rain or near the sea.

1. Clean the motorcycle with cold water and a mild detergent, after the engine has cooled down.
NOTICE: Do not use warm water since it increases the corrosive action of the salt. [ECA10791]

2. Apply a corrosion protection spray on all metal, including chrome- and nickel-plated, surfaces to prevent corrosion.

After cleaning

1. Dry the motorcycle with a chamois or an absorbing cloth.
2. Immediately dry the drive chain and lubricate it to prevent it from rusting.
3. Use a chrome polish to shine chrome, aluminum and stainless-steel parts, including the exhaust system. (Even the thermally induced discoloring of stainless-steel exhaust systems can be removed through polishing.)
4. To prevent corrosion, it is recommended to apply a corrosion protection spray on all metal, including chrome- and nickel-plated, surfaces.
5. Use spray oil as a universal cleaner to remove any remaining dirt.
6. Touch up minor paint damage caused by stones, etc.
7. Wax all painted surfaces.

- Let the motorcycle dry completely before storing or covering it.

EWA14501

WARNING

Contaminants on the brakes or tires can cause loss of control.

- **Make sure that there is no oil or wax on the tires.**
- **If necessary, wash the tires with warm water and a mild detergent. Before riding at higher speeds, test the motorcycle's braking performance and cornering behavior.**

ECA10800

NOTICE

- **Apply spray oil and wax sparingly and make sure to wipe off any excess.**
- **Never apply oil or wax to any rubber and plastic parts, but treat them with a suitable care product.**
- **Avoid using abrasive polishing compounds as they will wear away the paint.**

TIP

Consult a Yamaha dealer for advice on what products to use.

Storage

EAU26152

Short-term

Always store your motorcycle in a cool, dry place and, if necessary, protect it against dust with a porous cover. Be sure the engine and the exhaust system are cool before covering the motorcycle.

ECA10810

NOTICE

- **Storing the motorcycle in a poorly ventilated room or covering it with a tarp, while it is still wet, will allow water and humidity to seep in and cause rust.**
- **To prevent corrosion, avoid damp cellars, stables (because of the presence of ammonia) and areas where strong chemicals are stored.**

Long-term

Before storing your motorcycle for several months:

- Follow all the instructions in the "Care" section of this chapter.

MOTORCYCLE CARE AND STORAGE

2. For motorcycles equipped with a fuel cock that has an “OFF” position: Turn the fuel cock lever to “OFF”.
3. Drain the carburetor float chamber by loosening the drain bolt; this will prevent fuel deposits from building up. Pour the drained fuel into the fuel tank.
4. Fill up the fuel tank and add fuel stabilizer (if available) to prevent the fuel tank from rusting and the fuel from deteriorating.
5. Perform the following steps to protect the cylinder, piston rings, etc. from corrosion.
 - a. Remove the spark plug cap and spark plug.
 - b. Pour a teaspoonful of engine oil into the spark plug bore.
 - c. Install the spark plug cap onto the spark plug, and then place the spark plug on the cylinder head so that the electrodes are grounded. (This will limit sparking during the next step.)
 - d. Turn the engine over several times with the starter. (This will coat the cylinder wall with oil.)

WARNING! To prevent damage or injury from sparking, make sure to ground the spark plug electrodes while turning the engine over.

[EWA10951]

- e. Remove the spark plug cap from the spark plug, and then install the spark plug and the spark plug cap.
6. Lubricate all control cables and the pivoting points of all levers and pedals as well as of the side-stand/centerstand.
7. Check and, if necessary, correct the tire air pressure, and then lift the motorcycle so that both of its wheels are off the ground. Alternatively, turn the wheels a little every month in order to prevent the tires from becoming degraded in one spot.
8. Cover the muffler outlet with a plastic bag to prevent moisture from entering it.
9. Remove the battery and fully charge it. Store it in a cool, dry place and charge it once a month. Do not store the battery in an ex-

cessively cold or warm place [less than 0 °C (30 °F) or more than 30 °C (90 °F)]. For more information on storing the battery, see page 7-26.

TIP

Make any necessary repairs before storing the motorcycle.

Dimensions:

- Overall length:
1565 mm (61.6 in)
- Overall width:
680 mm (26.8 in)
- Overall height:
923 mm (36.3 in)
- Seat height:
670 mm (26.4 in)
- Wheelbase:
1080 mm (42.5 in)
- Ground clearance:
180 mm (7.09 in)
- Minimum turning radius:
1660 mm (65.4 in)

Weight:

- Curb weight:
72 kg (159 lb)

Noise and vibration level:

- Noise level (77/311/EEC):
TT-R110E 78.9 dB(A)
TT-R110EB 78.9 dB(A) (ZAF)
- Vibration on seat (EN1032, ISO5008):
TT-R110E Will not exceed 0.5 m/s²
TT-R110EB Will not exceed 0.5 m/s² (ZAF)
- Vibration on handlebar (EN1032, ISO5008):
TT-R110E Will not exceed 2.5 m/s²
TT-R110EB Will not exceed 2.5 m/s² (ZAF)

Engine:

- Engine type:
Air cooled 4-stroke, SOHC
- Cylinder arrangement:
Single cylinder

- Displacement:
110 cm³
- Bore × stroke:
51.0 × 54.0 mm (2.01 × 2.13 in)
- Compression ratio:
9.30 : 1
- Starting system:
Electric starter and kickstarter
- Lubrication system:
Wet sump

Engine oil:

- Recommended brand:
YAMALUBE
- Type:
SAE 10W-30, 10W-40, 10W-50, 15W-40,
20W-40 or 20W-50

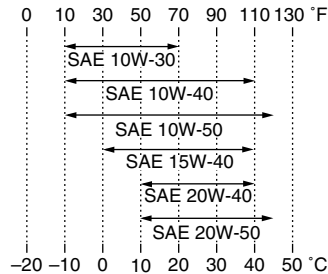

- Recommended engine oil grade:
API service SG type or higher, JASO
standard MA
- Engine oil quantity:
Periodic oil change:
0.80 L (0.85 US qt, 0.70 Imp.qt)

Air filter:

- Air filter element:
Wet element

Fuel:

- Recommended fuel:
TT-R110E Regular unleaded gasoline or
gasohol (E10)
TT-R110EB Regular unleaded gasoline or
gasohol (E10) (CAN)(ZAF)
TT-R110EB Unleaded gasoline or gasohol
(E10) (AUS)
- Fuel tank capacity:
3.8 L (1.00 US gal, 0.84 Imp.gal)
- Fuel reserve amount:
0.5 L (0.13 US gal, 0.11 Imp.gal)

Carburetor:

- Type × quantity:
VM16 x 1

Spark plug(s):

- Manufacturer/model:
NGK/CR6HSA
- Spark plug gap:
0.6–0.7 mm (0.024–0.028 in)

Clutch:

- Clutch type:
Wet, multiple-disc and centrifugal
automatic

Transmission:

- Primary reduction ratio:
3.722 (67/18)
- Final drive:
Chain
- Secondary reduction ratio:
2.500 (35/14)

SPECIFICATIONS

Transmission type:

Constant mesh 4-speed

Operation:

Left foot operation

Gear ratio:

1st:

3.166 (38/12)

2nd:

1.941 (33/17)

3rd:

1.380 (29/21)

4th:

1.095 (23/21)

Chassis:

Frame type:

Backbone

Caster angle:

26.00 °

Trail:

60 mm (2.4 in)

Front tire:

Type:

With tube

Size:

2.50-14 4PR

Manufacturer/model:

CHEN SHIN/C-803-2

Rear tire:

Type:

With tube

Size:

3.00-12 4PR

Manufacturer/model:

CHEN SHIN/C-803-2

Loading:

Maximum rider weight:

60.0 kg (132 lb)

Tire air pressure (measured on cold tires):

Front:

100 kPa (1.00 kgf/cm², 15 psi)

Rear:

100 kPa (1.00 kgf/cm², 15 psi)

Front wheel:

Wheel type:

Spoke wheel

Rim size:

14x1.40

Rear wheel:

Wheel type:

Spoke wheel

Rim size:

12x1.60

Front brake:

Type:

Drum brake

Operation:

Right hand operation

Rear brake:

Type:

Drum brake

Operation:

Right foot operation

Front suspension:

Type:

Telescopic fork

Spring/shock absorber type:

Coil spring/oil damper

Wheel travel:

115.0 mm (4.53 in)

Rear suspension:

Type:

Swingarm

Spring/shock absorber type:

Coil spring/gas-oil damper

Wheel travel:

110.0 mm (4.33 in)

Electrical system:

Ignition system:

DC CDI

Charging system:

AC magneto

Battery:

Model:

GT4B-5

Voltage, capacity:

12 V, 2.5 Ah

Fuse:

Fuse:

10.0 A

EAU51130

For EUR only

The figures quoted are emission levels and are not necessarily safe working levels. Whilst there is a correlation between the emission and exposure levels, this cannot be used reliably to determine whether or not further precautions are required. Factors that influence the actual level of exposure of work-force include the characteristics of the work room, the other sources of noise, etc. i.e. the number of machines and other adjacent processes, and the length of time for which an operator is exposed to the noise. Also the permissible exposure level can vary from country. This information, however, will enable the user of the machine to make a better evaluation of the hazard and risk.

CONSUMER INFORMATION

EAU40792

Identification numbers

Record the vehicle identification number and model label information in the spaces provided below for assistance when ordering spare parts from a Yamaha dealer or for reference in case the vehicle is stolen.

VEHICLE IDENTIFICATION
NUMBER:

MODEL LABEL INFORMATION:

EAU26400

Vehicle identification number

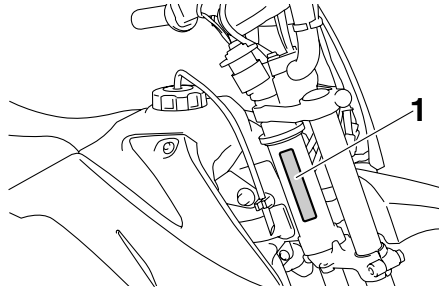

1. Vehicle identification number

The vehicle identification number is stamped into the steering head pipe. Record this number in the space provided.

TIP

The vehicle identification number is used to identify your motorcycle and may be used to register your motorcycle with the licensing authority in your area.

EAU36980

Model label

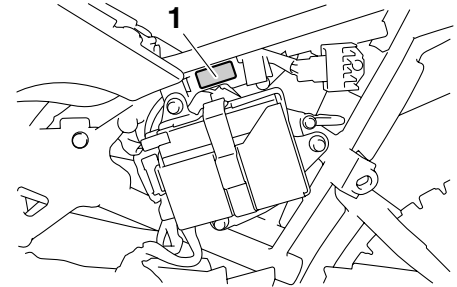

1. Model label

The model label is affixed to the frame behind panel B. (See page 7-7.) Record the information on this label in the space provided. This information will be needed when ordering spare parts from a Yamaha dealer.

EAU48120

Vehicle Emission Control Information label (For Canada)

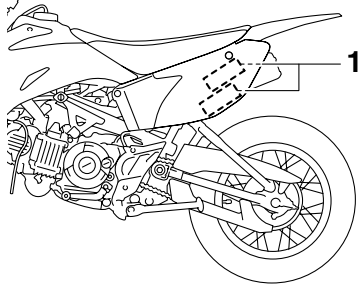

1. Vehicle Emission Control Information label

The Vehicle Emission Control Information label is affixed at the location in the illustration. This label shows specifications related to exhaust emissions as required by federal law, state law and Environment Canada.

INDEX

- A**
 - Air filter element, cleaning..... 7-11
- B**
 - Battery..... 7-26
 - Brake lever..... 4-2
 - Brake lever, checking and lubricating ... 7-23
 - Brake lever free play, adjusting..... 7-18
 - Brake pedal..... 4-3
 - Brake pedal, checking and lubricating 7-23
 - Brake pedal free play, adjusting..... 7-19
 - Brake shoes, checking 7-20
- C**
 - Cables, checking and lubricating 7-22
 - Carburetor, adjusting 7-14
 - Care 8-1
 - Clutch free play, adjusting..... 7-17
- D**
 - Drive chain, cleaning and lubricating 7-22
 - Drive chain slack..... 7-20
- E**
 - Engine break-in..... 6-3
 - Engine idling speed..... 7-14
 - Engine oil 7-9
 - Engine, starting a warm 6-2
 - Engine stop switch 4-2
- F**
 - Front fork, checking 7-24
 - Fuel..... 4-3
 - Fuel cock..... 4-5
 - Fuel tank breather hose..... 4-5
 - Fuel tank cap 4-3
 - Fuse, replacing 7-27
- H**
 - Handlebar switches 4-1
- I**
 - Identification numbers 10-1
- K**
 - Kickstarter..... 4-6
- L**
 - Labels, location..... 1-1
- M**
 - Main switch..... 4-1
 - Maintenance and lubrication, periodic 7-4
 - Maintenance, emission control system... 7-3
 - Matte color, caution 8-1
 - Model label 10-1
- P**
 - Panels, removing and installing..... 7-7
 - Parking 6-4
 - Part locations..... 3-1
- S**
 - Safety information..... 2-1
 - Seat 4-7
 - Shifting..... 6-2
 - Shift pedal..... 4-2
 - Shift pedal, checking 7-19
 - Shock absorber assembly 4-7
 - Sidestand..... 4-8
 - Sidestand, checking and lubricating 7-24
 - Spark arrester, cleaning 7-13
 - Spark plug, checking 7-8
 - Specifications 9-1
 - Starter (choke) lever 4-6
 - Starting and warming up a cold engine 6-1
 - Starting circuit cut-off system 4-8
- T**
 - Start switch..... 4-2
 - Steering, checking..... 7-25
 - Storage..... 8-3
 - Supporting the motorcycle 7-28
 - Swingarm pivots, lubricating 7-24
- T**
 - Throttle grip and cable, checking and lubricating 7-23
 - Throttle grip free play, checking 7-15
 - Tires 7-15
 - Tool kit..... 7-2
 - Troubleshooting 7-32
 - Troubleshooting chart 7-33
- V**
 - Valve clearance..... 7-15
 - Vehicle Emission Control Information label (For Canada)..... 10-2
 - Vehicle identification number 10-1
- W**
 - Wheel bearings, checking 7-25
 - Wheel (front) 7-28
 - Wheel (rear) 7-30
 - Wheels 7-17



PRINTED ON RECYCLED PAPER

PRINTED IN JAPAN
2011.06-0.5×1 CR
(E)