



OWNER'S MANUAL

**Need's**

**YN50**

**5C2-F819D-E0**

# INTRODUCTION

---

EAU10110

Welcome to the Yamaha world of motorcycling!

As the owner of the YN50, you are benefiting from Yamaha's vast experience and newest technology regarding the design and manufacture of high-quality products, which have earned Yamaha a reputation for dependability.

Please take the time to read this manual thoroughly, so as to enjoy all advantages of your YN50. The owner's manual does not only instruct you in how to operate, inspect and maintain your scooter, but also in how to safeguard yourself and others from trouble and injury.

In addition, the many tips given in this manual will help keep your scooter in the best possible condition. If you have any further questions, do not hesitate to contact your Yamaha dealer.

The Yamaha team wishes you many safe and pleasant rides. So, remember to put safety first!

# IMPORTANT MANUAL INFORMATION

EAU84111

Particularly important information is distinguished in this manual by the following notations:

	<b>The Safety Alert Symbol means ATTENTION! BECOME ALERT! YOUR SAFETY IS INVOLVED!</b>
<b>⚠ WARNING</b>	<b>Failure to follow WARNING instructions <u>could result in severe injury or death</u> to the scooter operator, a bystander, or a person inspecting or repairing the scooter.</b>
<b>CAUTION:</b>	<b>A CAUTION indicates special precautions that must be taken to avoid damage to the scooter.</b>
<b>NOTE:</b>	A NOTE provides key information to make procedures easier or clearer.

## NOTE:

- This manual should be considered a permanent part of this scooter and should remain with it even if the scooter is subsequently sold.
- Yamaha continually seeks advancements in product design and quality. Therefore, while this manual contains the most current product information available at the time of printing, there may be minor discrepancies between your scooter and this manual. If you have any questions concerning this manual, please consult your Yamaha dealer.

EWA12410

## **⚠ WARNING**

**PLEASE READ THIS MANUAL CAREFULLY AND COMPLETELY BEFORE OPERATING THIS SCOOTER.**

\*Product and specifications are subject to change without notice.

# IMPORTANT MANUAL INFORMATION

---

EAUS1172

**YN50  
OWNER'S MANUAL  
©2007 by YAMAHA MOTOR ESPAÑA S.A.  
1st edition, March 2007  
All rights reserved.  
Any reprinting or unauthorized use  
without the written permission of  
YAMAHA MOTOR ESPAÑA S.A.  
is expressly prohibited.  
Printed in Neederland.**

# TABLE OF CONTENTS

## INTRODUCTION

## IMPORTANT MANUAL INFORMATION

## TABLE OF CONTENTS

<b>SAFETY INFORMATION</b> .....	1-1
Further safe-riding points .....	1-4

<b>DESCRIPTION</b> .....	2-1
Left view .....	2-1
Right view .....	2-2
Controls and instruments .....	2-3

## INSTRUMENT AND CONTROL

<b>FUNCTIONS</b> .....	3-1
Main switch/steering lock.....	3-1
Indicator and warning lights .....	3-2
Multi-function display .....	3-3
Handlebar switches .....	3-5
Front brake lever.....	3-6
Rear brake lever.....	3-6
Fuel and 2-stroke engine oil tank caps.....	3-6
Fuel .....	3-7
Fuel tank breather/overflow hose .....	3-8
Catalytic converter.....	3-8
2-stroke engine oil .....	3-8
Kickstarter .....	3-9
Seat.....	3-9
Storage compartment.....	3-10

Luggage hook.....	3-11
-------------------	------

<b>PRE-OPERATION CHECKS</b> .....	4-1
Pre-operation check list.....	4-2

## OPERATION AND IMPORTANT

<b>RIDING POINTS</b> .....	5-1
Starting a cold engine .....	5-1
Starting off .....	5-2
Acceleration and deceleration .....	5-2
Braking.....	5-2
Tips for reducing fuel consumption.....	5-3
Engine break-in.....	5-3
Parking.....	5-4

## PERIODIC MAINTENANCE AND

<b>MINOR REPAIR</b> .....	6-1
Periodic maintenance and lubrication chart .....	6-2
Removing and installing the cowling and panel.....	6-5
Checking the spark plug .....	6-6
Final transmission oil .....	6-7
Air filter element.....	6-8
Adjusting the carburetor .....	6-8
Adjusting the throttle cable free play.....	6-8
Tires .....	6-9
Cast wheels .....	6-11

Checking the front brake lever free play.....	6-11
Adjusting the rear brake lever free play.....	6-11
Checking the front brake pads and rear brake shoes .....	6-12
Checking the front brake fluid level .....	6-13
Changing the brake fluid .....	6-14
Checking and lubricating the cables.....	6-14
Checking and lubricating the throttle grip and cable .....	6-14
Adjusting the Autolube pump.....	6-15
Lubricating the front and rear brake levers .....	6-15
Checking and lubricating the centerstand .....	6-15
Checking the front fork.....	6-16
Checking the steering.....	6-16
Checking the wheel bearings .....	6-17
Battery .....	6-17
Replacing the fuse.....	6-19
Replacing the headlight bulb.....	6-20
Replacing a front turn signal light bulb.....	6-21
Replacing a turn signal light bulb or the tail/brake light bulb .....	6-22
Troubleshooting .....	6-23
Troubleshooting chart.....	6-24

# TABLE OF CONTENTS

---

---

## **SCOOTER CARE AND STORAGE** .....7-1

Matte color caution.....7-1

Care .....7-1

Storage .....7-3

## **SPECIFICATIONS** .....8-1

## **CONSUMER INFORMATION** .....9-1

Identification numbers .....9-1

EAUT1010

SCOOTERS ARE SINGLE TRACK VEHICLES. THEIR SAFE USE AND OPERATION ARE DEPENDENT UPON THE USE OF PROPER RIDING TECHNIQUES AS WELL AS THE EXPERTISE OF THE OPERATOR. EVERY OPERATOR SHOULD KNOW THE FOLLOWING REQUIREMENTS BEFORE RIDING THIS SCOOTER. HE OR SHE SHOULD:

- OBTAIN THOROUGH INSTRUCTIONS FROM A COMPETENT SOURCE ON ALL ASPECTS OF SCOOTER OPERATION.
- OBSERVE THE WARNINGS AND MAINTENANCE REQUIREMENTS IN THE OWNER'S MANUAL.
- OBTAIN QUALIFIED TRAINING IN SAFE AND PROPER RIDING TECHNIQUES.
- OBTAIN PROFESSIONAL TECHNICAL SERVICE AS INDICATED BY THE OWNER'S MANUAL AND/OR WHEN MADE NECESSARY BY MECHANICAL CONDITIONS.

## Safe riding

- Always make pre-operation checks. Careful checks may help prevent an accident.
- This scooter is designed to carry the operator and passenger.

## NOTE: \_\_\_\_\_

Although this scooter is designed to carry a passenger, always comply with the local regulations.

- The failure of motorists to detect and recognize scooters in traffic is the predominating cause of automobile/scooter accidents. Many accidents have been caused by an automobile driver who did not see the scooter. Making yourself conspicuous appears to be very effective in reducing the chance of this type of accident.

## Therefore:

- Wear a brightly colored jacket.
- Use extra caution when approaching and passing through intersections, since intersections are the most likely places for scooter accidents to occur.

- Ride where other motorists can see you. Avoid riding in another motorist's blind spot.
- Many accidents involve inexperienced operators. In fact, many operators who have been involved in accidents do not even have a current driver's license.
- Make sure that you are qualified and that you only lend your scooter to other qualified operators.
- Know your skills and limits. Staying within your limits may help you to avoid an accident.
- We recommend that you practice riding your scooter where there is no traffic until you have become thoroughly familiar with the scooter and all of its controls.
- Many accidents have been caused by error of the scooter operator. A typical error made by the operator is veering wide on a turn due to EXCESSIVE SPEED or under cornering (insufficient lean angle for the speed).

# SAFETY INFORMATION

---

1

- Always obey the speed limit and never travel faster than warranted by road and traffic conditions.
- Always signal before turning or changing lanes. Make sure that other motorists can see you.
- The posture of the operator and passenger is important for proper control.
- The operator should keep both hands on the handlebar and both feet on the footboard during operation to maintain control of the scooter.
- The passenger should always hold onto the operator, the seat strap or grab bar, if equipped, with both hands and keep both feet on the passenger footrests.
- Never carry a passenger unless he or she can firmly place both feet on the passenger footrests.
- Never ride under the influence of alcohol or other drugs.

- This scooter is designed for on-road use only. It is not suitable for off-road use.

## **Protective apparel**

The majority of fatalities from scooter accidents are the result of head injuries. The use of a safety helmet is the single most critical factor in the prevention or reduction of head injuries.

- Always wear an approved helmet.
- Wear a face shield or goggles. Wind in your unprotected eyes could contribute to an impairment of vision which could delay seeing a hazard.
- The use of a jacket, substantial shoes, trousers, gloves, etc., is effective in preventing or reducing abrasions or lacerations.
- Never wear loose-fitting clothes, otherwise they could catch on the control levers or wheels and cause injury or an accident.
- Never touch the engine or exhaust system during or after operation. They become very hot and can cause burns. Always wear protective clothing that

covers your legs, ankles, and feet.

- Passengers should also observe the above precautions.

## **Modifications**

Modifications made to this scooter not approved by Yamaha, or the removal of original equipment, may render the scooter unsafe for use and may cause severe personal injury. Modifications may also make your scooter illegal to use.

## **Loading and accessories**

Adding accessories or cargo to your scooter can adversely affect stability and handling if the weight distribution of the scooter is changed. To avoid the possibility of an accident, use extreme caution when adding cargo or accessories to your scooter. Use extra care when riding a scooter that has added cargo or accessories. Here are some general guidelines to follow if loading cargo or adding accessories to your scooter:



## Loading

The total weight of the operator, passenger, accessories and cargo must not exceed the maximum load limit of 163 kg (359 lb). When loading within this weight limit, keep the following in mind:

- Cargo and accessory weight should be kept as low and close to the scooter as possible. Make sure to distribute the weight as evenly as possible on both sides of the scooter to minimize imbalance or instability.
- Shifting weights can create a sudden imbalance. Make sure that accessories and cargo are securely attached to the scooter before riding. Check accessory mounts and cargo restraints frequently.
- Never attach any large or heavy items to the handlebar, front fork, or front fender. Such items can create unstable handling or a slow steering response.

## Accessories

Genuine Yamaha accessories have been specifically designed for use on this scooter. Since Yamaha cannot test all other accessories that may be available, you must personally be responsible for the proper selection, installation and use of non-Yamaha accessories. Use extreme caution when selecting and installing any accessories.

Keep the following guidelines in mind, as well as those provided under “Loading” when mounting accessories.

- Never install accessories or carry cargo that would impair the performance of your scooter. Carefully inspect the accessory before using it to make sure that it does not in any way reduce ground clearance or cornering clearance, limit suspension travel, steering travel or control operation, or obscure lights or reflectors.

- Accessories fitted to the handlebar or the front fork area can create instability due to improper weight distribution or aerodynamic changes. If accessories are added to the handlebar or front fork area, they must be as lightweight as possible and should be kept to a minimum.
- Bulky or large accessories may seriously affect the stability of the scooter due to aerodynamic effects. Wind may attempt to lift the scooter, or the scooter may become unstable in cross winds. These accessories may also cause instability when passing or being passed by large vehicles.
- Certain accessories can displace the operator from his or her normal riding position. This improper position limits the freedom of movement of the operator and may limit control ability, therefore, such accessories are not recommended.

# SAFETY INFORMATION

EAU10371

- Use caution when adding electrical accessories. If electrical accessories exceed the capacity of the scooter's electrical system an electric failure could result, which could cause a dangerous loss of lights or engine power.

## Gasoline and exhaust gas

- **GASOLINE IS HIGHLY FLAMMABLE:**
  - Always turn the engine off when refueling.
  - Take care not to spill any gasoline on the engine or exhaust system when refueling.
  - Never refuel while smoking or in the vicinity of an open flame.
- Never start the engine or let it run for any length of time in a closed area. The exhaust fumes are poisonous and may cause loss of consciousness and death within a short time. Always operate your scooter in an area that has adequate ventilation.

- Always turn the engine off before leaving the scooter unattended and remove the key from the main switch. When parking the scooter, note the following:
  - The engine and exhaust system may be hot, therefore, park the scooter in a place where pedestrians or children are not likely to touch these hot areas.
  - Do not park the scooter on a slope or soft ground, otherwise it may fall over.
  - Do not park the scooter near a flammable source (e.g., a kerosene heater, or near an open flame), otherwise it could catch fire.
- If you should swallow any gasoline, inhale a lot of gasoline vapor, or allow gasoline to get into your eyes, see your doctor immediately. If any gasoline spills on your skin or clothing, immediately wash the affected area with soap and water and change your clothes.

## Further safe-riding points

- Be sure to signal clearly when making turns.
- Braking can be extremely difficult on a wet road. Avoid hard braking, because the scooter could slide. Apply the brakes slowly when stopping on a wet surface.
- Slow down as you approach a corner or turn. Once you have completed a turn, accelerate slowly.
- Be careful when passing parked cars. A driver might not see you and open a door in your path.
- Railroad crossings, streetcar rails, iron plates on road construction sites, and manhole covers become extremely slippery when wet. Slow down and cross them with caution. Keep the scooter upright, otherwise it could slide out from under you.
- The brake pads could get wet when you wash the scooter. After washing the scooter, check the brakes before riding.

- Always wear a helmet, gloves, trousers (tapered around the cuff and ankle so they do not flap), and a bright colored jacket.
- Do not carry too much luggage on the scooter. An overloaded scooter is unstable.

# DESCRIPTION

EAU10410

## Left view

2

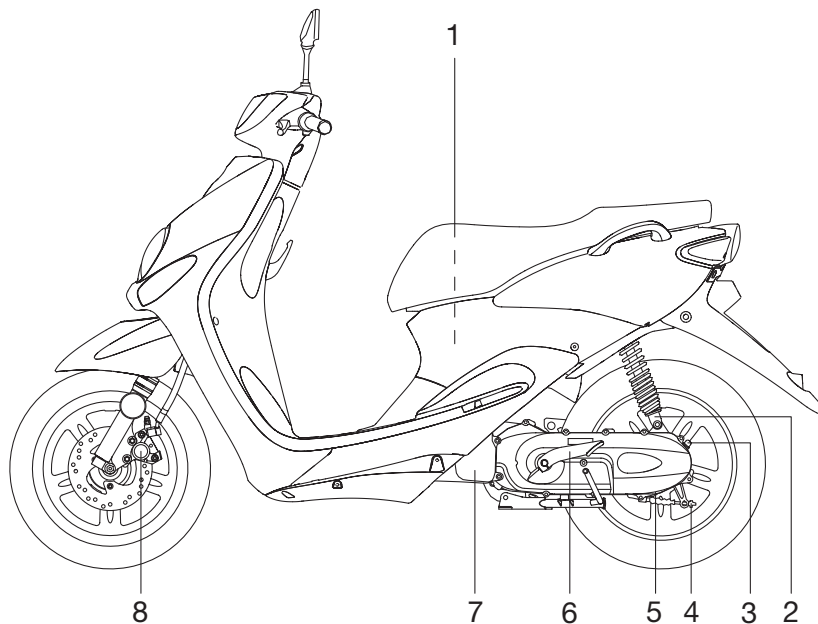

1. Storage compartment (page 3-10)

2. Shock absorber assembly

3. Final transmission oil filler cap (page 6-7)

4. Adjusting nut (page 6-11)

5. Final transmission oil drain bolt (page 6-7)

6. Kickstarter (page 3-9)

7. Air filter element (page 6-8)

8. Front brake pads (page 6-12)

## Right view

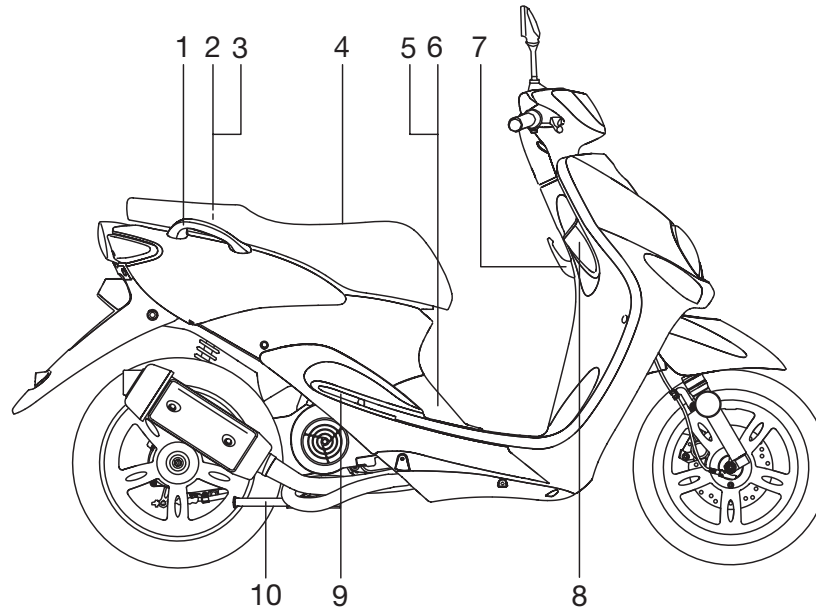

1. Grab bar (page 5-2)
2. Oil tank cap (page 3-6)
3. Fuel tank cap (page 3-6)
4. Seat (page 3-9)
5. Battery (page 6-17)

6. Fuse (page 6-19)
7. Luggage hook (page 3-11)
8. Main switch / steering lock (page 3-1)
9. Passenger footrest
10. Centerstand (page 6-15)

# DESCRIPTION

EAU10430

## Controls and instruments

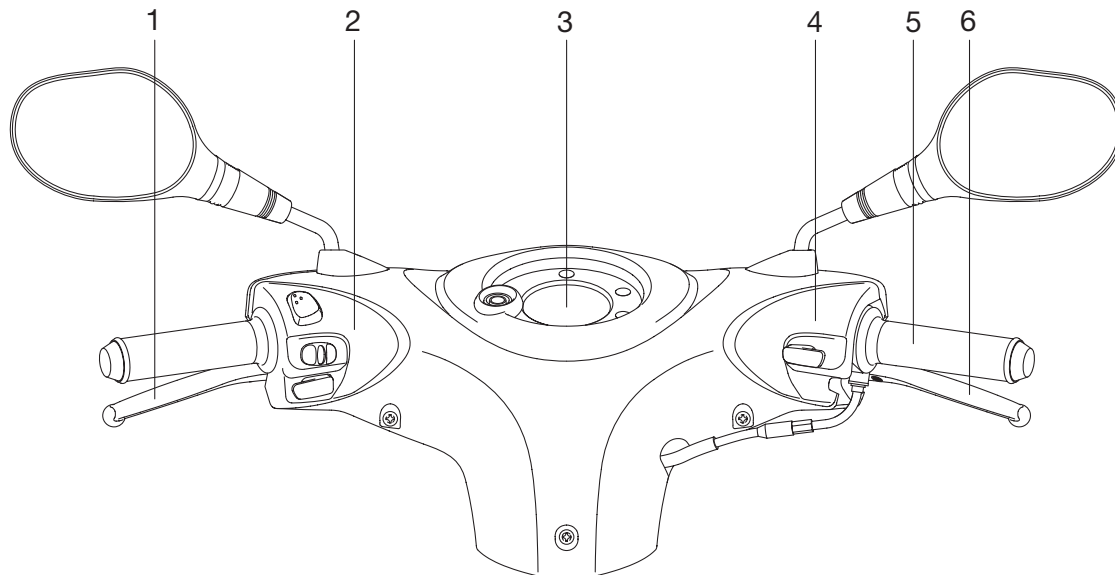

1. Rear brake lever (page 3-6)
2. Left handlebar switches (page 3-5)
3. Multi-function display (page 3-3)

4. Right handlebar switches (page 3-5)
5. Throttle grip (page 6-8)
6. Front brake lever (page 3-6)

# INSTRUMENT AND CONTROL FUNCTIONS

## Main switch/steering lock

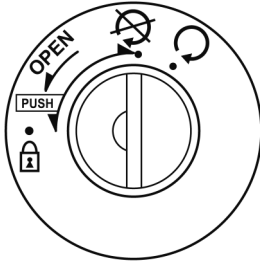

ZAJM0253

The main switch/steering lock controls the ignition and lighting systems, and is used to lock the steering. The various positions are described below.

### ON “○”

All electrical circuits are supplied with power, the meter lighting comes on, and the engine can be started. The key cannot be removed.

### NOTE:

The headlight and taillight come on automatically when the engine is started.

EAU10460

### OFF “☒”

All electrical systems are off. The key can be removed.

### LOCK “🔒”

The steering is locked, and all electrical systems are off. The key can be removed.

#### To lock the steering

1. Turn the handlebars all the way to the left.
2. Push the key in from the “☒” position, and then turn it to “🔒” while still pushing it.
3. Remove the key.

#### To unlock the steering

Push the key in, and then turn it to “☒” while still pushing it.

EAU10660

EAU10680

### **⚠ WARNING**

**Never turn the key to “☒” or “🔒” while the vehicle is moving, otherwise the electrical systems will be switched off, which may result in loss of control or an accident. Make sure that the vehicle is stopped before turning the key to “☒” or “🔒”.**

# INSTRUMENT AND CONTROL FUNCTIONS

EAU11003

## Indicator and warning lights

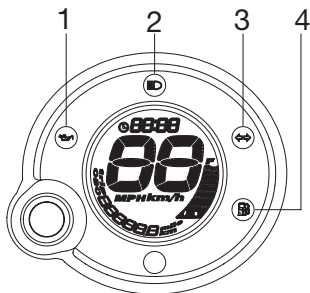

1. Oil level warning light “”
2. High beam indicator light “”
3. Turn signal indicator light “”
4. Fuel level warning light “”

EAU11020

### Turn signal indicator light “”

This indicator light flashes when the turn signal switch is pushed to the left or right.

EAU11080

### High beam indicator light “”

This indicator light comes on when the high beam of the headlight is switched on.

EAUM1061

### Oil level warning light “”

This warning light comes when the oil level in the 2-stroke engine oil tank is low during operation. If the warning light comes on during operation, stop immediately and fill the oil tank with 2-stroke engine oil of either JASO grade "FC" or ISO grades "EG-C" or "EG-D". The warning light should go off after the 2-stroke engine oil tank has been refilled.

#### NOTE: \_\_\_\_\_

The electrical circuit of the warning light can be checked by turning the key to "O".

If the warning light does not come on for a few seconds, then go off, or does not go off after the 2-stroke engine oil tank has been refilled, have a Yamaha dealer check the electrical circuit.

ECA10010

#### CAUTION: \_\_\_\_\_

**Do not operate the vehicle until you know that the engine oil level is sufficient.**

EAU11350

### Fuel level warning light “”

This warning light comes on when the fuel level drops below approximately 1.4L (0.37 US gal) (0.31 Imp gal). When this occurs, refuel as soon as possible.

The electrical circuit of the warning light can be checked by turning the key to "O".

If the warning light does not come on for a few seconds, then go off, have a Yamaha dealer check the electrical circuit.



# INSTRUMENT AND CONTROL FUNCTIONS

## Multi-function display

EAUS1391

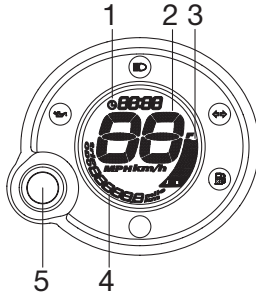

1. Digital clock
2. Digital speedometer
3. Fuel meter
4. Odometer/tripmeters
5. Button

### NOTE:

The multi-function display performs the following self-test for three seconds in order to check the electrical circuit.

- The speedometer digits display from 0 to 99, and then from 99 to 0 in kilometers. If the speedometer is set to miles, the digits display from 0 to 65, and then from 65 to 0.

- All LCD segments and warning lights come on and then go off.

### WARNING

**Be sure to stop the vehicle before making any setting changes to the multi-function display.**

EWA12311

The multi-function display is equipped with the following:

- a digital clock
- a digital speedometer (which shows riding speed)
- an odometer (which shows the total distance traveled)
- a tripmeter (which shows the distance traveled since it was last set to zero)
- a fuel reserve tripmeter (which shows the distance traveled on the fuel reserve)
- a fuel gauge
- a self-diagnosis device

### NOTE:

- Be sure to turn the key to “O” before using the button.
- For the U.K. only: To switch the speedometer and odometer/tripmeter displays between kilometers and miles, when the main switch is turned to “O”, press the button for at least eight seconds.

To set the clock:

1. Select the odometer and push the button for at least three seconds.
2. When the hour digits start flashing, push the button to set the hours.

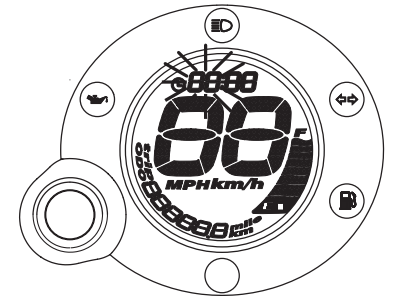

# INSTRUMENT AND CONTROL FUNCTIONS

3. To change the minutes digits, push the button for at least three seconds.
4. When the minutes digits start flashing, push the button to set the minutes.

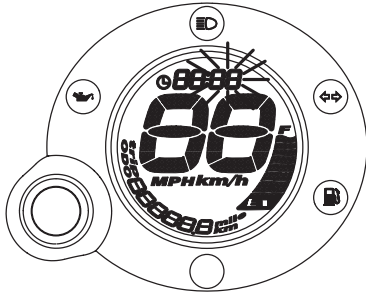

3

5. Push the button for at least three seconds to start the clock.

**NOTE:** \_\_\_\_\_  
 After setting the clock, be sure to push the button for at least three seconds before turning the key to "⊗", otherwise the clock will not be set.

## Odometer and tripmeter modes

Pushing the button switches the display between the odometer mode "ODO" and the tripmeter "TRIP" in the following order:

ODO → TRIP → ODO

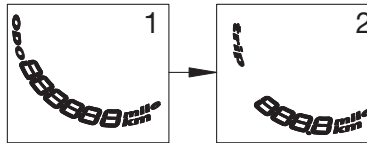

1. Odometer
2. Tripmeter

If the fuel level warning indicator comes on (see page 3-2), the odometer display will automatically change to the fuel reserve tripmeter mode "TRIP F" and start counting the distance traveled from that point. In that case, pushing the button switches the display between the various tripmeter and odometer modes in the following order:

TRIP F → ODO → TRIP → TRIP F

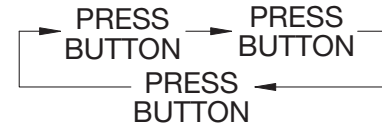

1. Fuel reserve tripmeter
2. Odometer
3. Tripmeter

To reset a tripmeter, select it by pushing the button, and then push it again for at least three seconds. If you do not reset the fuel reserve tripmeter manually, it will reset itself automatically and the display will return to the prior mode after refueling and traveling 5 km (3 mi).

**NOTE:** \_\_\_\_\_  
 The display cannot be changed back to "TRIP F" after pushing the button.

# INSTRUMENT AND CONTROL FUNCTIONS

## Fuel gauge

The fuel gauge indicates the amount of fuel in the fuel tank. The display segments of the fuel gauge disappear towards “E” (Empty) as the fuel level decreases. When only two segments are left near “E”, the fuel level warning indicator comes on. Refuel as soon as possible.

## Self-diagnosis device

This model is equipped with a self-diagnosis device for the fuel electrical circuit.

If the fuel electrical circuit is defective, all LCD segments of the fuel gauge and the fuel level warning indicator will flash. If this occurs, have a Yamaha dealer check the vehicle.

EAU12347

## Handlebar switches

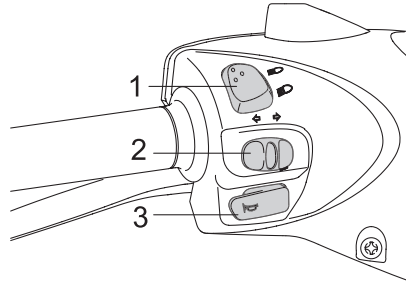

1. Dimmer switch “ $\equiv D / \equiv D$ ”
2. Turn signal switch “ $\blacktriangleleft / \blacktriangleright$ ”
3. Horn switch “ $\text{H}$ ”

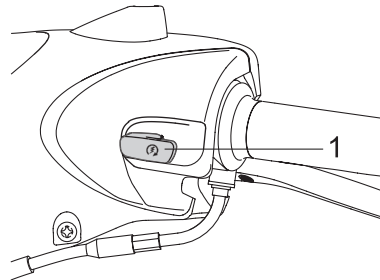

1. Start switch “ $\text{S}$ ”

EAU12400

## Dimmer switch “ $\equiv D / \equiv D$ ”

Set this switch to “ $\equiv D$ ” for the high beam and to “ $\equiv D$ ” for the low beam.

EAU12460

## Turn signal switch “ $\blacktriangleleft / \blacktriangleright$ ”

To signal a right-hand turn, push this switch to “ $\blacktriangleright$ ”. To signal a left-hand turn, push this switch to “ $\blacktriangleleft$ ”. When released, the switch returns to the center position. To cancel the turn signal lights, push the switch in after it has returned to the center position.

EAU12500

## Horn switch “ $\text{H}$ ”

Press this switch to sound the horn.

EAUM1131

## Start switch “ $\text{S}$ ”

Push this switch while applying the front or rear brake to crank the engine with the starter.

ECA10050

## CAUTION:

See page 5-1 for starting instructions prior to starting the engine.

# INSTRUMENT AND CONTROL FUNCTIONS

EAU12900

## Front brake lever

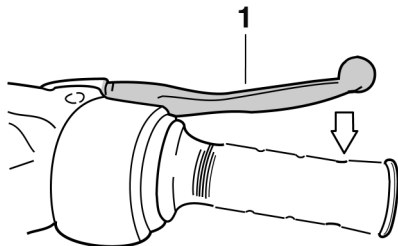

ZAUJ0084

### 1. Front brake lever

The front brake lever is located on the right handlebar grip. To apply the front brake, pull this lever toward the handlebar grip.

EAU12950

## Rear brake lever

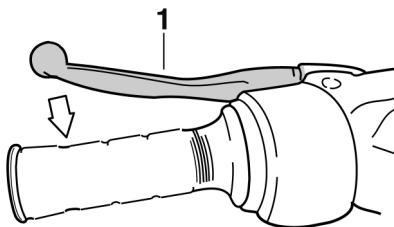

ZAUJ0085

### 1. Rear brake lever

The rear brake lever is located on the left handlebar grip. To apply the rear brake, pull this lever toward the handlebar grip.

EAU13201

## Fuel and 2-stroke engine oil tank caps

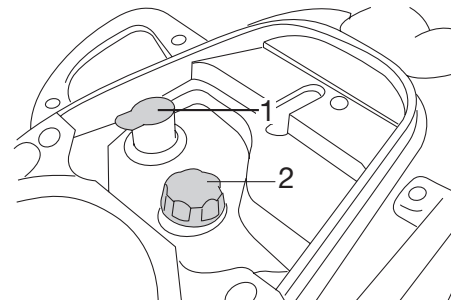

1. Oil tank cap
2. Fuel tank cap

The fuel tank cap and the 2-stroke engine oil tank cap are located under the seat. (See page 3-9.)

### Fuel tank cap

To remove the fuel tank cap, turn it counterclockwise, and then pull it off. To install the fuel tank cap, turn it clockwise.

### 2-stroke engine oil tank cap

To remove the 2-stroke engine oil tank cap, pull it off.

To install the 2-stroke engine oil tank cap, push it into the oil tank opening.

# INSTRUMENT AND CONTROL FUNCTIONS

## **⚠ WARNING**

EWA10140

Make sure that the fuel and 2-stroke engine oil tank caps are properly installed before riding the scooter.

## Fuel

EAU13211

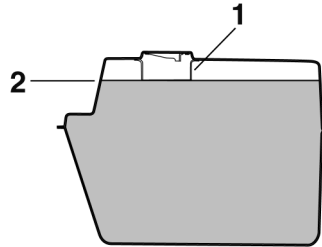

ZAJM0020

1. Fuel tank filler tube
2. Fuel level

Make sure that there is sufficient fuel in the tank. Fill the fuel tank to the bottom of the filler tube as shown.

## **⚠ WARNING**

EWA10880

- Do not overfill the fuel tank, otherwise it may overflow when the fuel warms up and expands.
- Avoid spilling fuel on the hot engine.

## **CAUTION:**

ECA10070

Immediately wipe off spilled fuel with a clean, dry, soft cloth, since fuel may deteriorate painted surfaces or plastic parts.

EAU13270

**Recommended fuel:**  
REGULAR UNLEADED GASOLINE ONLY  
**Fuel tank capacity:**  
6.1 L (1.61 US gal) (1.34 Imp.gal)  
**Fuel reserve amount:**  
1.4 L (0.37 US gal) (0.31 Imp.gal)

Your Yamaha engine has been designed to use regular unleaded gasoline with a research octane number of 91 or higher. If knocking (or pinging) occurs, use a gasoline of a different brand or premium unleaded fuel. Use of unleaded fuel will extend spark plug life and reduce maintenance costs.

# INSTRUMENT AND CONTROL FUNCTIONS

EAUB1300

## Fuel tank breather/overflow hose

Before operating the motorcycle:

- Check the fuel tank breather/overflow hose connection.
- Check the fuel tank breather/overflow hose for cracks or damage, and replace it if damaged.
- Make sure that the end of the fuel tank breather/overflow hose is not blocked, and clean it if necessary.
- Make sure that the end of the fuel tank breather/overflow hose is positioned inside of the clamp.

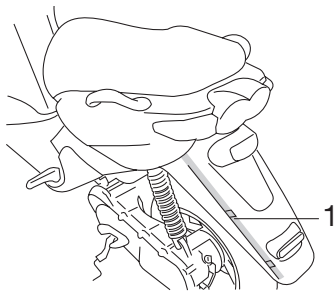

1. Fuel tank breather/overflow hose

EAU13431

## Catalytic converter

This model is equipped with a catalytic converter in the exhaust system.

EWA10860

### **⚠ WARNING**

**The exhaust system is hot after operation. Make sure that the exhaust system has cooled down before doing any maintenance work.**

ECA10700

### **CAUTION:**

**The following precautions must be observed to prevent a fire hazard or other damages.**

- Use only unleaded gasoline. The use of leaded gasoline will cause unreparable damage to the catalytic converter.
- Never park the vehicle near possible fire hazards such as grass or other materials that easily burn.
- Do not allow the engine to idle too long.

EAUM1150

## 2-stroke engine oil

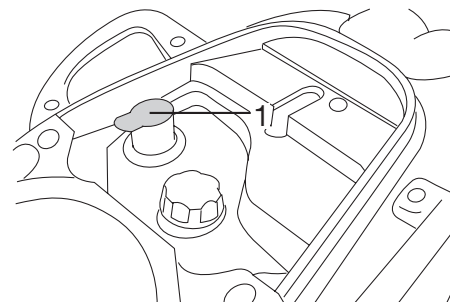

1. Oil tank cap

Make sure that there is sufficient oil in the 2-stroke engine oil tank. Add the recommended 2-stroke engine oil if necessary.

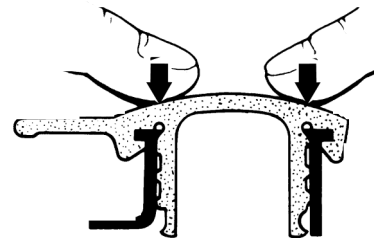

ZAM.com

# INSTRUMENT AND CONTROL FUNCTIONS

EAUS1050

EAU13932

**NOTE:**  
Make sure that the 2-stroke engine oil tank cap is properly installed.

**Recommended oil:**

2-stroke engine oil (JASO grade "FC", or ISO grades "EG-C" or "EG-D")

**Oil quantity:**

1.5 L (1.59 US qt) (1.32 Imp.qt)

## Kickstarter

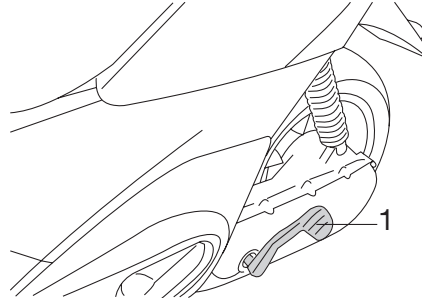

1. Kickstarter

To start the engine, push the kickstarter down lightly with your foot until the gears engage, and then push it down smoothly but forcefully.

## Seat

### To open the seat

1. Place the scooter on the centers-stand.
2. Insert the key into the main switch, and then turn it counter-clockwise to "OPEN".

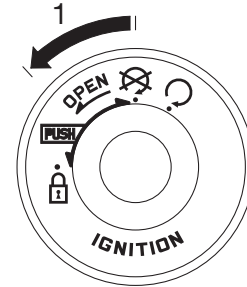

1. Open

**NOTE:**  
Do not push inward when turning the key.

3. Fold the seat up.

# INSTRUMENT AND CONTROL FUNCTIONS

3

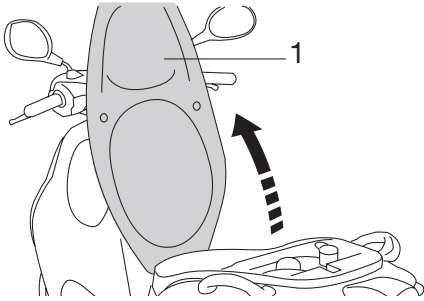

1. Seat

## To close the seat

1. Fold the seat down, and then push it down to lock it in place.
2. Remove the key from the main switch if the scooter will be left unattended.

**NOTE:** \_\_\_\_\_  
Make sure that the seat is properly secured before riding.  
\_\_\_\_\_

## Storage compartment

EAUM1191

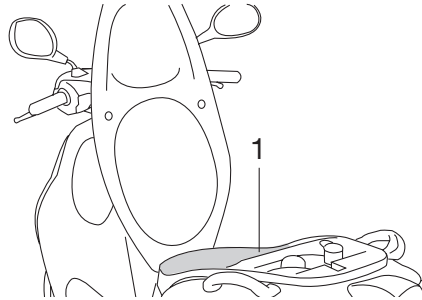

1. Storage compartment

There is a storage compartment under the seat. (See page 3-9.)

EWA10961

## **WARNING**

- Do not exceed the load limit of 5 kg (11.0 lb) for the storage compartment.
- Do not exceed the maximum load of 163 kg (359 lb) for the vehicle.

ECA10080

## **CAUTION:**

Keep the following points in mind when using the storage compartment.

- Since the storage compartment accumulates heat when exposed to the sun, do not store anything susceptible to heat inside it.
- To avoid humidity from spreading through the storage compartment, wrap wet articles in a plastic bag before storing them in the compartment.
- Since the storage compartment may get wet while the scooter is being washed, wrap any articles stored in the compartment in a plastic bag.
- Do not keep anything valuable or breakable in the storage compartment.

To store a helmet in the storage compartment, place the helmet with the front facing backward.

## **NOTE:**

- Some helmets cannot be stored in the storage compartment because of their size or shape.
- Do not leave your scooter unattended with the seat open.



EAUT1070

## Luggage hook

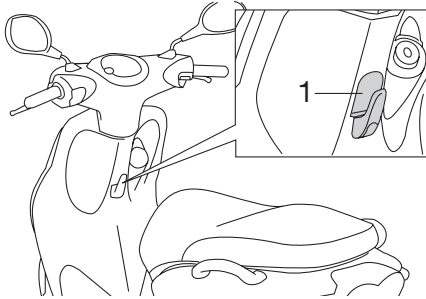

1. Luggage hook

EWAT1030

### **⚠ WARNING**

- Do not exceed the load limit of 3 kg (6.6 lb) for the luggage hook.
- Do not exceed the maximum load of 163 kg (359 lb) for the vehicle.

# PRE-OPERATION CHECKS

---

---

EAU15592

The condition of a vehicle is the owner's responsibility. Vital components can start to deteriorate quickly and unexpectedly, even if the vehicle remains unused (for example, as a result of exposure to the elements). Any damage, fluid leakage or loss of tire air pressure could have serious consequences. Therefore, it is very important, in addition to a thorough visual inspection, to check the following points before each ride.

## NOTE:

Pre-operation checks should be made each time the vehicle is used. Such an inspection can be accomplished in a very short time; and the added safety it assures is more than worth the time involved.

EWA11150

4

## **WARNING**

**If any item in the Pre-operation check list is not working properly, have it inspected and repaired before operating the vehicle.**

---

# PRE-OPERATION CHECKS

EAU15605

## Pre-operation check list

ITEM	CHECKS	PAGE
<b>Fuel</b>	<ul style="list-style-type: none"> <li>• Check fuel level in fuel tank.</li> <li>• Refuel if necessary.</li> <li>• Check fuel line for leakage.</li> </ul>	3-7, 3-8
<b>2-stroke engine oil</b>	<ul style="list-style-type: none"> <li>• Check oil level in oil tank.</li> <li>• If necessary, add recommended oil to specified level.</li> <li>• Check vehicle for oil leakage.</li> </ul>	3-6, 3-8
<b>Final transmission oil</b>	<ul style="list-style-type: none"> <li>• Check vehicle for oil leakage.</li> </ul>	6-7
<b>Front brake</b>	<ul style="list-style-type: none"> <li>• Check operation.</li> <li>• If soft or spongy, have Yamaha dealer bleed hydraulic system.</li> <li>• Check lever free play.</li> <li>• Adjust if necessary.</li> <li>• Check brake pads for wear.</li> <li>• Replace if necessary.</li> <li>• Check fluid level in reservoir.</li> <li>• If necessary, add recommended brake fluid to specified level.</li> <li>• Check hydraulic system for leakage.</li> </ul>	3-6, 6-11 ~ 6-14
<b>Rear brake</b>	<ul style="list-style-type: none"> <li>• Check operation.</li> <li>• Lubricate cable if necessary.</li> <li>• Check lever free play.</li> <li>• Adjust if necessary.</li> </ul>	3-6, 6-11, 6-12
<b>Throttle grip</b>	<ul style="list-style-type: none"> <li>• Make sure that operation is smooth.</li> <li>• Check cable free play.</li> <li>• If necessary, have Yamaha dealer adjust cable free play and lubricate cable and grip housing.</li> </ul>	6-8, 6-14
<b>Control cables</b>	<ul style="list-style-type: none"> <li>• Make sure that operation is smooth.</li> <li>• Lubricate if necessary.</li> </ul>	6-14
<b>Wheels and tires</b>	<ul style="list-style-type: none"> <li>• Check for damage.</li> <li>• Check tire condition and tread depth.</li> <li>• Check air pressure.</li> <li>• Correct if necessary.</li> </ul>	6-9, 6-11
<b>Brake levers</b>	<ul style="list-style-type: none"> <li>• Make sure that operation is smooth.</li> <li>• Lubricate lever pivoting points if necessary.</li> </ul>	3-6, 6-15

# PRE-OPERATION CHECKS

ITEM	CHECKS	PAGE
Centerstand	<ul style="list-style-type: none"><li>• Make sure that operation is smooth.</li><li>• Lubricate pivot if necessary.</li></ul>	6-15
Chassis fasteners	<ul style="list-style-type: none"><li>• Make sure that all nuts, bolts and screws are properly tightened.</li><li>• Tighten if necessary.</li></ul>	—
Instruments, lights, signals and switches	<ul style="list-style-type: none"><li>• Check operation.</li><li>• Correct if necessary.</li></ul>	—
Battery	<ul style="list-style-type: none"><li>• Check fluid level.</li><li>• Fill with distilled water if necessary.</li></ul>	6-17

# OPERATION AND IMPORTANT RIDING POINTS

EAU15980  
EWA10870

## **⚠ WARNING**

- Become thoroughly familiar with all operating controls and their functions before riding. Consult a Yamaha dealer regarding any control or function that you do not thoroughly understand.
- Never start the engine or operate it in a closed area for any length of time. Exhaust fumes are poisonous, and inhaling them can cause loss of consciousness and death within a short time. Always make sure that there is adequate ventilation.
- For safety, always start the engine with the centerstand down.

## Starting a cold engine

EAUT1100

ECA10250

### **CAUTION:**

See page 5-3 for engine break-in instructions prior to operating the vehicle for the first time.

1. Turn the key to “O”.
2. Close the throttle grip completely.
3. Start the engine by pushing the start switch or by kicking the kickstarter, while applying the front or rear brake.

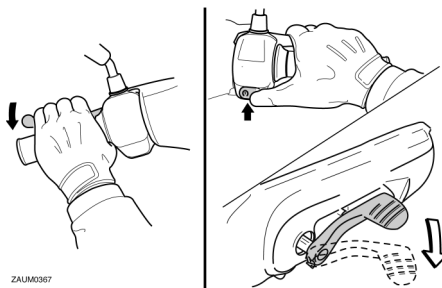

ZAJM0367

### **NOTE:**

If the engine fails to start by pushing the start switch, release the switch, wait a few seconds, and then try again. Each starting attempt should be as short as possible to preserve the battery. Do not crank the engine more than 5 seconds on any one attempt. If the engine does not start with the starter motor, try using the kickstarter.

ECA11040

### **CAUTION:**

For maximum engine life, never accelerate hard when the engine is cold!

# OPERATION AND IMPORTANT RIDING POINTS

EAU16760

## Starting off

### NOTE:

Before starting off, allow the engine to warm up.

1. While pulling the rear brake lever with your left hand and holding the grab bar with your right hand, push the scooter off the centerstand.

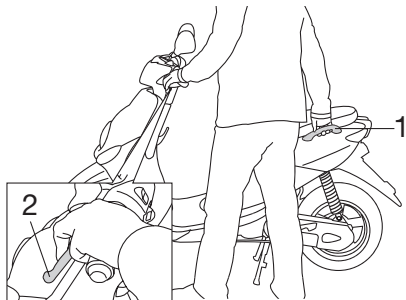

1. Grab bar
2. Rear brake lever

2. Sit astride the seat, and then adjust the rear view mirrors.
3. Switch the turn signal on.
4. Check for oncoming traffic, and then slowly turn the throttle grip (on the right) in order to take off.
5. Switch the turn signal off.

## Acceleration and deceleration

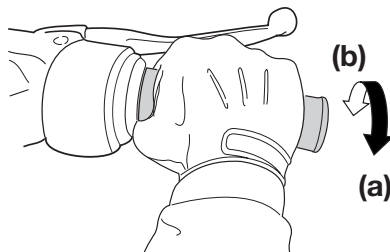

ZAUM0199

The speed can be adjusted by opening and closing the throttle. To increase the speed, turn the throttle grip in direction (a). To reduce the speed, turn the throttle grip in direction (b).

EAU16780

## Braking

1. Close the throttle completely.
2. Apply both front and rear brakes simultaneously while gradually increasing the pressure.

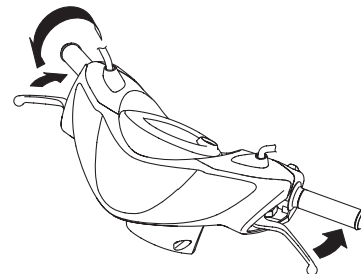

EWA10300

### **WARNING**

- **Avoid braking hard or suddenly (especially when leaning over to one side), otherwise the scooter may skid or overturn.**
- **Railroad crossings, streetcar rails, iron plates on road construction sites, and manhole covers become extremely slippery when wet. Therefore, slow**

# OPERATION AND IMPORTANT RIDING POINTS

down when approaching such areas and cross them with caution.

- **Keep in mind that braking on a wet road is much more difficult.**
- **Ride slowly down a hill, as braking downhill can be very difficult.**

EAU16820

## Tips for reducing fuel consumption

Fuel consumption depends largely on your riding style. Consider the following tips to reduce fuel consumption:

- Avoid high engine speeds during acceleration.
- Avoid high engine speeds with no load on the engine.
- Turn the engine off instead of letting it idle for an extended length of time (e.g., in traffic jams, at traffic lights or at railroad crossings).

EAU16830

## Engine break-in

There is never a more important period in the life of your engine than the period between 0 and 1000 km (600 mi). For this reason, you should read the following material carefully. Since the engine is brand new, do not put an excessive load on it for the first 1000 km (600 mi). The various parts in the engine wear and polish themselves to the correct operating clearances. During this period, prolonged full-throttle operation or any condition that might result in engine overheating must be avoided.

EAUM2090

### 0~150 km (0~90 mi)

Avoid prolonged operation above 1/3 throttle. Vary the speed of the scooter from time to time. Do not operate it at one set throttle position.

### 150~500 km (90~300 mi)

Avoid prolonged operation above 1/2 throttle.

### 500~1000 km (300~600 mi)

Avoid cruising speeds in excess of 3/4 throttle.

# OPERATION AND IMPORTANT RIDING POINTS

---

ECAM1070

## CAUTION:

After 1000 km (600 mi) of operation, the final transmission oil must be changed.

## 1000 km (600 mi) and beyond

Avoid prolonged full throttle operation. Vary speeds occasionally.

ECA10270

## CAUTION:

If any engine trouble should occur during the engine break-in period, immediately have a Yamaha dealer check the vehicle.

EAU17212

## Parking

When parking, stop the engine, and then remove the key from the main switch.

EWA10310

## WARNING

- Since the engine and exhaust system can become very hot, park in a place where pedestrians or children are not likely to touch them.
- Do not park on a slope or on soft ground, otherwise the vehicle may overturn.

ECA10380

## CAUTION:

Never park in an area where there are fire hazards such as grass or other flammable materials.



# PERIODIC MAINTENANCE AND MINOR REPAIR

---

EAU17280

Safety is an obligation of the owner. Periodic inspection, adjustment and lubrication will keep your vehicle in the safest and most efficient condition possible. The most important points of inspection, adjustment, and lubrication are explained on the following pages.

The intervals given in the periodic maintenance and lubrication chart should be simply considered as a general guide under normal riding conditions. However, DEPENDING ON THE WEATHER, TERRAIN, GEOGRAPHICAL LOCATION, AND INDIVIDUAL USE, THE MAINTENANCE INTERVALS MAY NEED TO BE SHORTENED.

EWA10320

## **WARNING**

---

**If you are not familiar with maintenance work, have a Yamaha dealer do it for you.**

---

EWA10330

## **WARNING**

---

**This scooter is designed for use on paved roads only. If this scooter is operated in abnormally dusty, muddy or wet conditions, the air filter element should be cleaned or replaced more frequently, otherwise rapid engine wear may result. Consult a Yamaha dealer for proper maintenance intervals.**

---

# PERIODIC MAINTENANCE AND MINOR REPAIR

EAU17711

## Periodic maintenance and lubrication chart

### NOTE:

- The annual checks must be performed every year, except if a kilometer-based maintenance is performed instead.
- From 30000 km, repeat the maintenance intervals starting from 6000 km.
- Items marked with an asterisk should be performed by a Yamaha dealer as they require special tools, data and technical skills.

NO.	ITEM	CHECK OR MAINTENANCE JOB	ODOMETER READING (x 1000 Km)					ANNUAL CHECK
			1	6	12	18	24	
1	* Fuel line	• Check fuel and vacuum hoses for cracks or damage.		√	√	√	√	√
2	* Spark plug	• Replace.		√	√	√	√	√
3	* Air filter element	• Clean.		√		√		
		• Replace.			√		√	
4	* Battery	• Check electrolyte level and specific gravity. • Make sure that the breather hose is properly routed.		√	√	√	√	√
5	* Front brake	• Check operation, fluid level and vehicle for fluid leakage.	√	√	√	√	√	√
		• Replace brake pads.	Whenever worn to the limit					
6	* Rear brake	• Check operation and adjust brake lever free play.	√	√	√	√	√	√
		• Replace brake shoes.	Whenever worn to the limit					
7	* Brake hose	• Check for cracks or damage.		√	√	√	√	√
		• Replace.	Every 4 years					
8	* Wheels	• Check runout and for damage.		√	√	√	√	

6

# PERIODIC MAINTENANCE AND MINOR REPAIR

NO.	ITEM	CHECK OR MAINTENANCE JOB	ODOMETER READING (x 1000 Km)					ANNUAL CHECK
			1	6	12	18	24	
9	* Tires	<ul style="list-style-type: none"> <li>• Check tread depth and for damage.</li> <li>• Replace if necessary.</li> <li>• Check air pressure.</li> <li>• Correct if necessary.</li> </ul>		√	√	√	√	√
10	* Wheel bearings	<ul style="list-style-type: none"> <li>• Check bearing for looseness or damage.</li> </ul>		√	√	√	√	
11	* Steering bearings	<ul style="list-style-type: none"> <li>• Check bearing play and steering for roughness.</li> <li>• Lubricate with lithium-soap-based grease.</li> </ul>	√	√	√	√	√	
12	* Chassis fasteners	<ul style="list-style-type: none"> <li>• Make sure that all nuts, bolts and screws are properly tightened.</li> </ul>		√	√	√	√	√
13	Sidestand, centerstand	<ul style="list-style-type: none"> <li>• Check operation.</li> <li>• Lubricate.</li> </ul>		√	√	√	√	√
14	* Front fork	<ul style="list-style-type: none"> <li>• Check operation and for oil leakage.</li> </ul>		√	√	√	√	
15	* Shock absorber assembly	<ul style="list-style-type: none"> <li>• Check operation and shock absorber for oil leakage.</li> </ul>		√	√	√	√	
16	* Carburetor	<ul style="list-style-type: none"> <li>• Adjust engine idling speed.</li> </ul>	√	√	√	√	√	√
17	* Autolube pump	<ul style="list-style-type: none"> <li>• Check operation.</li> <li>• Bleed if necessary.</li> </ul>	√		√		√	√
18	Final transmission oil	<ul style="list-style-type: none"> <li>• Check vehicle for oil leakage.</li> <li>• Initial 500 km</li> <li>• Change.</li> </ul>	√		√			
19	* V-belt	<ul style="list-style-type: none"> <li>• Replace.</li> </ul>						
20	* Front and rear brake switches	<ul style="list-style-type: none"> <li>• Check operation.</li> </ul>	√	√	√	√	√	√
21	Moving parts and cables	<ul style="list-style-type: none"> <li>• Lubricate.</li> </ul>		√	√	√	√	√

# PERIODIC MAINTENANCE AND MINOR REPAIR

NO.	ITEM	CHECK OR MAINTENANCE JOB	ODOMETER READING (x 1000 Km)					ANNUAL CHECK
			1	6	12	18	24	
22	* Throttle grip housing and cable	<ul style="list-style-type: none"> <li>• Check operation and free play.</li> <li>• Adjust the throttle cable free play if necessary.</li> <li>• Lubricate the throttle grip housing and cable.</li> </ul>		√	√	√	√	√
23	* Lights, signals and switches	<ul style="list-style-type: none"> <li>• Check operation.</li> <li>• Adjust headlight beam.</li> </ul>	√	√	√	√	√	√

EAUM2070

## NOTE:

- The air filter needs more frequent service if you are riding in unusually wet or dusty areas.
- Hydraulic brake service
  - Regularly check and, if necessary, correct the brake fluid level.
  - Every two years change the brake fluid.
  - Replace the brake hoses every four years and if cracked or damaged.

# PERIODIC MAINTENANCE AND MINOR REPAIR

EAU18740

## Removing and installing the cowling and panel

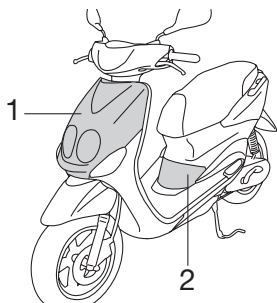

1. Cowling A
2. Panel A

The cowling and panel shown above need to be removed to perform some of the maintenance jobs described in this chapter. Refer to this section each time a cowling or panel needs to be removed and installed.

EAU18850

### Cowling A

#### To remove the cowling

Remove the cowling screws, and then pull the cowling off as shown.

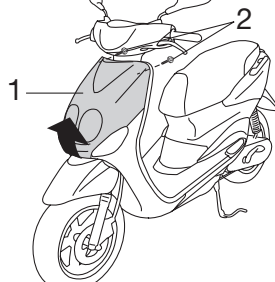

1. Cowling A
2. Screw

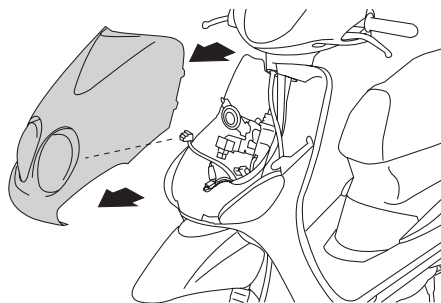

#### To install the cowling

Place the cowling in the original position, and then install the screws.

EAU19280

### Panel A

#### To remove the panel

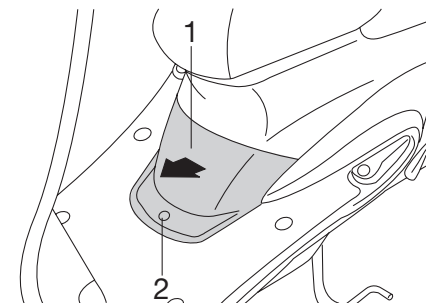

1. Panel A
2. Screw

Remove the screw, and then pull the panel off as shown.

#### To install the panel

Place the panel in the original position, and then install the screw.

# PERIODIC MAINTENANCE AND MINOR REPAIR

## Checking the spark plug

EAU19621

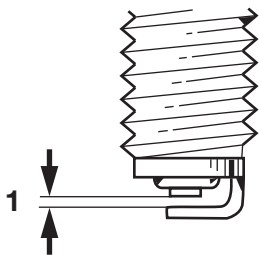

ZAU1M0037

### 1. Spark plug gap

The spark plug is an important engine component, which should be checked periodically, preferably by a Yamaha dealer. Since heat and deposits will cause any spark plug to slowly erode, it should be removed and checked in accordance with the periodic maintenance and lubrication chart. In addition, the condition of the spark plug can reveal the condition of the engine.

The porcelain insulator around the center electrode of the spark plug should be a medium-to-light tan (the ideal color when the vehicle is ridden normally). If the spark plug shows a distinctly different color, the engine could be operating improperly. Do not attempt to diagnose such problems yourself. Instead, have a Yamaha dealer check the vehicle.

If the spark plug shows signs of electrode erosion and excessive carbon or other deposits, it should be replaced.

#### Specified spark plug:

Std version: NGK / BR8HS  
Mofa version: NGK / BPR4HS

Before installing a spark plug, the spark plug gap should be measured with a wire thickness gauge and, if necessary, adjusted to specification.

#### Spark plug gap:

Std version: 0.6 ~ 0.7 mm (0.024 ~ 0.028 in)  
Mofa version: 0.6 ~ 0.7 mm (0.024 ~ 0.028 in)

Clean the surface of the spark plug gasket and its mating surface, and then wipe off any grime from the spark plug threads.

#### Tightening torque:

Spark plug:  
20 Nm (2.0 m•kgf, 14.5 ft•lbf)

#### NOTE:

If a torque wrench is not available when installing a spark plug, a good estimate of the correct torque is 1/4~1/2 turn past finger tight. However, the spark plug should be tightened to the specified torque as soon as possible.

# PERIODIC MAINTENANCE AND MINOR REPAIR

EAU20061

EWA11310

## Final transmission oil

The final transmission case must be checked for oil leakage before each ride. If any leakage is found, have a Yamaha dealer check and repair the scooter. In addition, the final transmission oil must be changed as follows at the intervals specified in the periodic maintenance and lubrication chart.

1. Start the engine, warm up the final transmission oil by riding the scooter for several minutes, and then stop the engine.
2. Place the scooter on the centerstand.
3. Place an oil pan under the final transmission case to collect the used oil.
4. Remove the oil filler cap and drain bolt to drain the oil from the final transmission case.

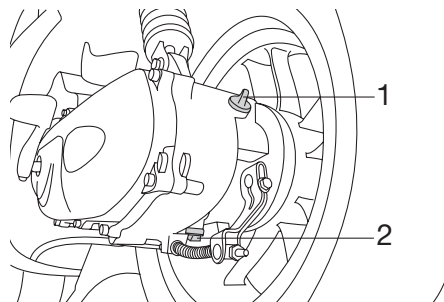

1. Final transmission oil filler cap
2. Final transmission oil drain bolt

5. Install the final transmission oil drain bolt, and then tighten it to the specified torque.

### Tightening torque:

Final transmission oil drain bolt:  
18 Nm (1.8 m•kgf, 13.0 ft•lbf)

6. Add the specified amount of the recommended final transmission oil, and then install and tighten the oil filler cap.

### Recommended final transmission oil:

See page 8-1.

### Oil quantity:

0.11 L (0.12 US qt) (0.10 Imp.qt)

## ⚠ WARNING

- Make sure that no foreign material enters the final transmission case.
- Make sure that no oil gets on the tire or wheel.

7. Check the final transmission case for oil leakage. If oil is leaking, check for the cause.

# PERIODIC MAINTENANCE AND MINOR REPAIR

EAU40370

## Air filter element

The air filter element must be cleaned and replaced at the intervals specified in the periodic maintenance and lubrication chart. Have a Yamaha dealer clean and replace the air filter element.

EAU21300

## Adjusting the carburetor

The carburetor is an important part of the engine and requires very sophisticated adjustment. Therefore, all carburetor adjustments should be left to a Yamaha dealer, who has the necessary professional knowledge and experience.

EAU21370

## Adjusting the throttle cable free play

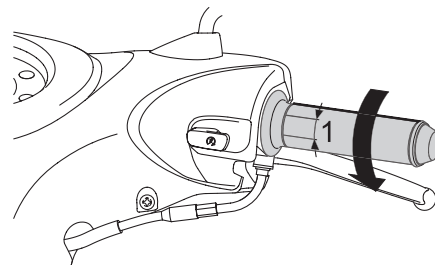

1. Throttle cable free play

The throttle cable free play should measure 4 ~ 6 mm (0.16 ~ 0.24 in) at the throttle grip. Periodically check the throttle cable free play and, if necessary, adjust it as follows.

**NOTE:** \_\_\_\_\_

The engine idling speed must be correctly adjusted before checking and adjusting the throttle cable free play.



# PERIODIC MAINTENANCE AND MINOR REPAIR

EAU33600

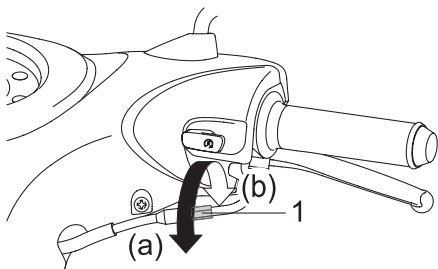

1. Adjusting nut

1. To increase the throttle cable free play, turn the adjusting nut in direction (a). To decrease the throttle cable free play, turn the adjusting nut in direction (b).

## Tires

To maximize the performance, durability, and safe operation of your vehicle, note the following points regarding the specified tires.

### Tire air pressure

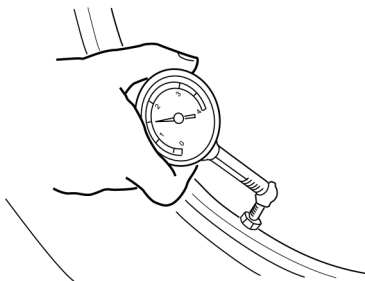

The tire air pressure should be checked and, if necessary, adjusted before each ride.

EWA10500

### **⚠ WARNING**

- The tire air pressure must be checked and adjusted on cold tires (i.e., when the temperature of the tires equals the ambient temperature).

- The tire air pressure must be adjusted in accordance with the riding speed and with the total weight of rider, passenger, cargo, and accessories approved for this model.

### Tire air pressure (measured on cold tires):

0~90 kg (0~198 lb):

Front:

175 kPa (25 psi) (1.75 kgf/cm<sup>2</sup>)

Rear:

200 kPa (28 psi) (2.00 kgf/cm<sup>2</sup>)

90 kg~163 kg (198 lb~359 lb):

Front:

175 kPa (25 psi) (1.75 kgf/cm<sup>2</sup>)

Rear:

225 kPa (32psi) (2.25kgf/cm<sup>2</sup>)

### Maximum load\*:

163 kg (359 lb)

\* Total weight of rider, passenger, cargo and accessories

# PERIODIC MAINTENANCE AND MINOR REPAIR

EWA11200

## ⚠ WARNING

Because loading has an enormous impact on the handling, braking, performance and safety characteristics of your vehicle, you should keep the following precautions in mind.

- **NEVER OVERLOAD THE VEHICLE!** Operation of an overloaded motorcycle may result in tire damage, loss of control, or severe injury. Make sure that the total weight of rider, passenger, cargo, and accessories does not exceed the specified maximum load for the vehicle.
- Do not carry along loosely packed items, which can shift during a ride.
- Securely pack the heaviest items close to the center of the vehicle and distribute the weight evenly on both sides.
- Adjust the tire air pressure with regard to the load.
- Check the tire condition and air pressure before each ride.

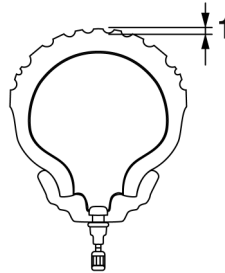

ZAJUM0054

1. Tire tread depth

## Tire inspection

The tires must be checked before each ride. If the center tread depth reaches the specified limit, if the tire has a nail or glass fragments in it, or if the sidewall is cracked, have a Yamaha dealer replace the tire immediately.

**Minimum tire tread depth (front and rear):**  
1.6 mm (0.06 in)

## NOTE:

The tire tread depth limits may differ from country to country. Always comply with the local regulations.

## Tire information

This model is equipped with tubeless tires.

### Front tire:

Size:

120/70 - 12 51L

Manufacturer/model:

Vee Rubber

Continental / Zippy 1

Pirelli / SL26

### Rear tire:

Size:

130/70 - 12 56L

Manufacturer/model:

Vee Rubber

Continental / Zippy 1

Pirelli / SL26

EWA10470

## ⚠ WARNING

- **Have a Yamaha dealer replace excessively worn tires. Besides being illegal, operating the vehicle with excessively worn tires decreases riding stability and can lead to loss of control.**
- **The replacement of all wheel and brake related parts, including the tires, should be left to a Yamaha dealer, who has the necessary professional knowledge and experience.**

# PERIODIC MAINTENANCE AND MINOR REPAIR

EAU21960

## Cast wheels

To maximize the performance, durability, and safe operation of your motorcycle, note the following points regarding the specified wheels.

- The wheel rims should be checked for cracks, bends or warpage before each ride. If any damage is found, have a Yamaha dealer replace the wheel. Do not attempt even the smallest repair to the wheel. A deformed or cracked wheel must be replaced.
- The wheel should be balanced whenever either the tire or wheel has been changed or replaced. An unbalanced wheel can result in poor performance, adverse handling characteristics, and a shortened tire life.
- Ride at moderate speeds after changing a tire since the tire surface must first be “broken in” for it to develop its optimal characteristics.

EAUT1220

## Checking the front brake lever free play

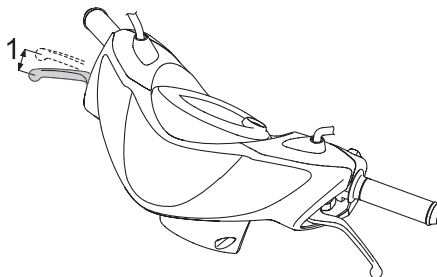

1. Front brake lever free play

The brake lever free play should measure 2 ~ 5 mm (0.08 ~ 0.20 in) as shown. Periodically check the brake lever free play and, if necessary, have a Yamaha dealer check the brake system.

EWA10640

### **⚠ WARNING**

**An incorrect brake lever free play indicates a hazardous condition in the brake system. Do not operate the motorcycle until the brake system has been checked or repaired by a Yamaha dealer.**

EAU22170

## Adjusting the rear brake lever free play

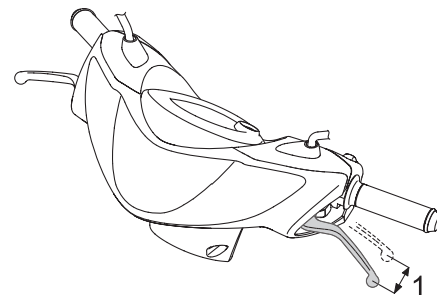

1. Rear brake lever free play

The brake lever free play should measure 5 ~ 10 mm (0.20 ~ 0.39 in) as shown. Periodically check the brake lever free play and, if necessary, adjust it as follows.

# PERIODIC MAINTENANCE AND MINOR REPAIR

EAU22380

EAU43170

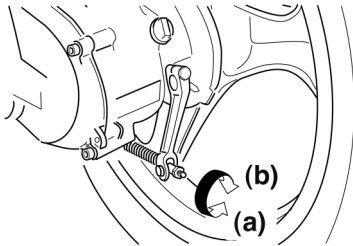

ZAUJ0320

## 1. Adjusting nut

To increase the brake lever free play, turn the adjusting nut at the brake shoe plate in direction (a). To decrease the brake lever free play, turn the adjusting nut in direction (b).

EWA10650

## **⚠ WARNING**

If proper adjustment cannot be obtained as described, have a Yamaha dealer make this adjustment.

## Checking the front brake pads and rear brake shoes

The front brake pads and the rear brake shoes must be checked for wear at the intervals specified in the periodic maintenance and lubrication chart.

EAU22400

### Front brake pads

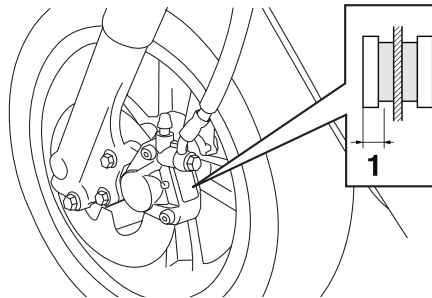

#### 1. Lining thickness

Check each front brake pad for damage and measure the lining thickness. If a brake pad is damaged or if the lining thickness is less than 3.1 mm (0.12 in), have a Yamaha dealer replace the brake pads as a set.

### Rear brake shoes

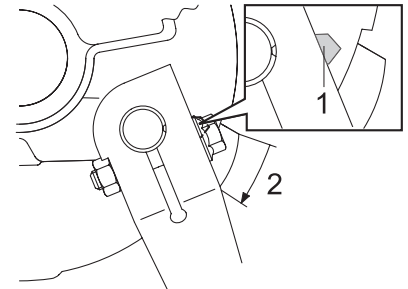

1. Wear indicator
2. Wear limit

The rear brake is provided with a wear indicator, which allows you to check the brake shoe wear without having to disassemble the brake. To check the brake shoe wear, check the position of the wear indicator while applying the brake. If a brake shoe has worn to the point that the wear indicator reaches the wear limit mark, have a Yamaha dealer replace the brake shoes as a set.

# PERIODIC MAINTENANCE AND MINOR REPAIR

EAU32343

## Checking the front brake fluid level

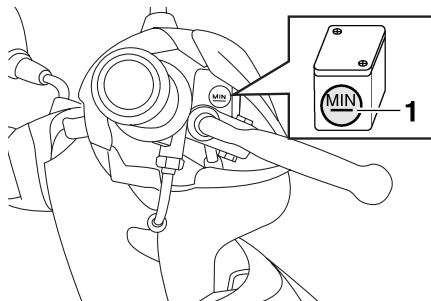

1. Minimum level mark

Insufficient brake fluid may allow air to enter the brake system, possibly causing it to become ineffective. Before riding, check that the brake fluid is above the minimum level mark and replenish if necessary. A low brake fluid level may indicate worn brake pads and/or brake system leakage. If the brake fluid level is low, be sure to check the brake pads for wear and the brake system for leakage. Observe these precautions:

- When checking the fluid level, make sure that the top of the master cylinder is level by turning the handlebars.
- Use only the recommended quality brake fluid, otherwise the rubber seals may deteriorate, causing leakage and poor braking performance.
- As the brake pads wear, it is normal for the brake fluid level to gradually go down. However, if the brake fluid level goes down suddenly, have a Yamaha dealer check the cause.

**Recommended brake fluid:**  
DOT 4

- Refill with the same type of brake fluid. Mixing fluids may result in a harmful chemical reaction and lead to poor braking performance.
- Be careful that water does not enter the master cylinder when refilling. Water will significantly lower the boiling point of the fluid and may result in vapor lock.
- Brake fluid may deteriorate painted surfaces or plastic parts. Always clean up spilled fluid immediately.

# PERIODIC MAINTENANCE AND MINOR REPAIR

---

EAUM1360

## Changing the brake fluid

Have a Yamaha dealer change the brake fluid at the intervals specified in the periodic maintenance and lubrication chart. In addition, have the brake hose replaced every four years or whenever it is damaged or leaking.

EAU23100

## Checking and lubricating the cables

The operation of all control cables and the condition of the cables should be checked before each ride, and the cables and cable ends should be lubricated if necessary. If a cable is damaged or does not move smoothly, have a Yamaha dealer check or replace it.

EAU23111

## Checking and lubricating the throttle grip and cable

The operation of the throttle grip should be checked before each ride. In addition, the cable should be lubricated at the intervals specified in the periodic maintenance chart.

**Recommended lubricant:**

Engine oil

6

EWA10720

 **WARNING**

**Damage to the outer sheath may interfere with proper cable operation and will cause the inner cable to rust. Replace a damaged cable as soon as possible to prevent unsafe conditions.**

---

# PERIODIC MAINTENANCE AND MINOR REPAIR

EAU23120

## Adjusting the Autolube pump

The Autolube pump is a vital and sophisticated component of the engine, which must be adjusted by a Yamaha dealer at the intervals specified in the periodic maintenance and lubrication chart.

## Lubricating the front and rear brake levers

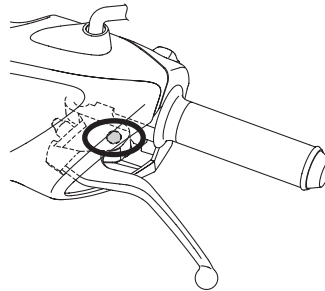
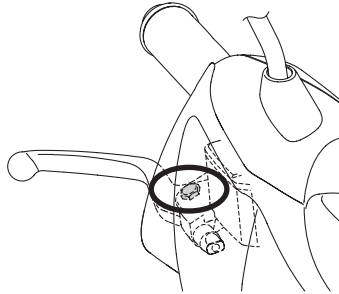

The pivoting points of the front and rear brake levers must be lubricated at the intervals specified in the periodic maintenance and lubrication chart.

**Recommended lubricant:**  
Silicone grease

EAU23172

## Checking and lubricating the centerstand

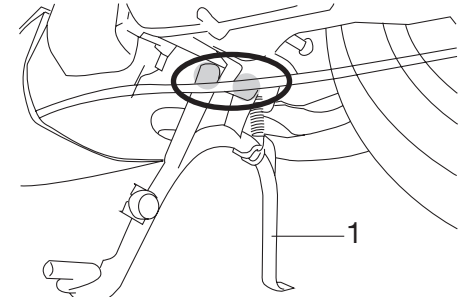

1. Centerstand

The operation of the centerstand should be checked before each ride, and the pivots and metal-to-metal contact surfaces should be lubricated if necessary.

**⚠ WARNING**

**If the centerstand does not move up and down smoothly, have a Yamaha dealer check or repair it.**

**Recommended lubricant:**

Lithium-soap-based grease (all-purpose grease)

EAU23191

# PERIODIC MAINTENANCE AND MINOR REPAIR

EAU23271

## Checking the front fork

The condition and operation of the front fork must be checked as follows at the intervals specified in the periodic maintenance and lubrication chart.

### To check the condition

EWA10750

#### **⚠ WARNING**

**Securely support the motorcycle so that there is no danger of it falling over.**

Check the inner tubes for scratches, damage and excessive oil leakage.

### To check the operation

1. Place the motorcycle on a level surface and hold it in an upright position.
2. While applying the front brake, push down hard on the handlebars several times to check if the front fork compresses and rebounds smoothly.

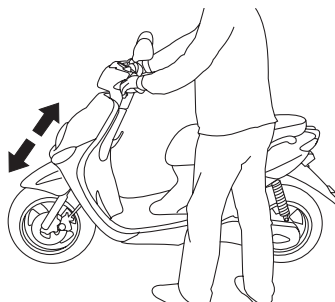

ECA10590

#### **CAUTION:**

**If any damage is found or the front fork does not operate smoothly, have a Yamaha dealer check or repair it.**

EAU23280

## Checking the steering

Worn or loose steering bearings may cause danger. Therefore, the operation of the steering must be checked as follows at the intervals specified in the periodic maintenance and lubrication chart.

1. Place a stand under the engine to raise the front wheel off the ground.

EWA10750

#### **⚠ WARNING**

**Securely support the motorcycle so that there is no danger of it falling over.**

2. Hold the lower ends of the front fork legs and try to move them forward and backward. If any free play can be felt, have a Yamaha dealer check or repair the steering.



# PERIODIC MAINTENANCE AND MINOR REPAIR

EAU23290

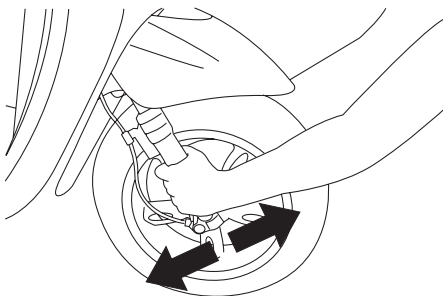

## Checking the wheel bearings

The front and rear wheel bearings must be checked at the intervals specified in the periodic maintenance and lubrication chart. If there is play in the wheel hub or if the wheel does not turn smoothly, have a Yamaha dealer check the wheel bearings.

EAU23321

## Battery

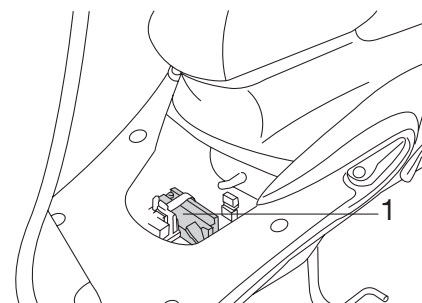

1. Battery

A poorly maintained battery will corrode and discharge quickly. The electrolyte level, battery lead connections and breather hose routing should be checked before each ride and at the intervals specified in the periodic maintenance and lubrication chart.

# PERIODIC MAINTENANCE AND MINOR REPAIR

## To check the electrolyte level

1. Place the vehicle on a level surface and hold it in an upright position.

### NOTE:

Make sure that the vehicle is positioned straight up when checking the electrolyte level.

2. Remove panel A. (See page 6-5.)
3. Check the electrolyte level in the battery.

### NOTE:

The electrolyte should be between the minimum and maximum level marks.

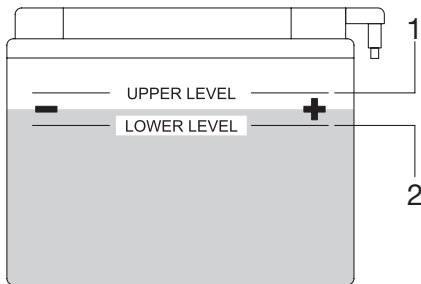

1. Maximum level mark
2. Minimum level mark

4. If the electrolyte is at or below the minimum level mark, add distilled water to raise it to the maximum level mark.

EWA10770

### **⚠ WARNING**

- **Electrolyte is poisonous and dangerous since it contains sulfuric acid, which causes severe burns. Avoid any contact with skin, eyes or clothing and always shield your eyes when working near batteries. In case of contact, administer the following FIRST AID.**
  - **EXTERNAL:** Flush with plenty of water.
  - **INTERNAL:** Drink large quantities of water or milk and immediately call a physician.
  - **EYES:** Flush with water for 15 minutes and seek prompt medical attention.

- **Batteries produce explosive hydrogen gas. Therefore, keep sparks, flames, cigarettes, etc., away from the battery and provide sufficient ventilation when charging it in an enclosed space.**
- **Take care not to spill electrolyte on the drive chain, as this may weaken it, shorten chain life and possibly result in an accident.**
- **KEEP THIS AND ALL BATTERIES OUT OF THE REACH OF CHILDREN.**

ECA10610

### **CAUTION:**

Use only distilled water, as tap water contains minerals that are harmful to the battery.

5. Check and, if necessary, tighten the battery lead connections and correct the breather hose routing.
6. Install the panel.

# PERIODIC MAINTENANCE AND MINOR REPAIR

EAU23502

ECA10640

## To store the battery

1. If the vehicle will not be used for more than one month, remove the battery, fully charge it, and then place it in a cool, dry place.
2. If the battery will be stored for more than two months, check the specific gravity of the electrolyte at least once a month and fully charge the battery whenever necessary.
3. Fully charge the battery before installation.
4. After installation, make sure that the battery leads are properly connected to the battery terminals and that the breather hose is properly routed, in good condition, and not obstructed.

ECA10600

### CAUTION:

If the breather hose is positioned in such a way that the frame is exposed to electrolyte or gas expelled from the battery, the frame could suffer structural and external damages.

## Replacing the fuse

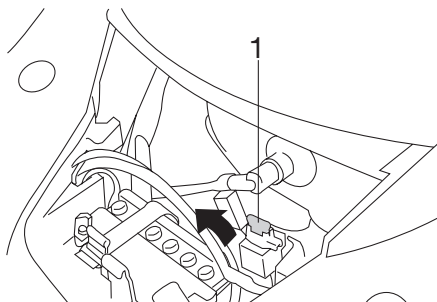

1. Main fuse

The fuse holder is located behind panel A. (See page 6-5.)

If the fuse is blown, replace it as follows.

1. Turn the key to “ $\otimes$ ” and turn off all electrical circuits.
2. Remove the blown fuse, and then install a new fuse of the specified amperage.

Specified fuse:

7.5 A

### CAUTION:

Do not use a fuse of a higher amperage rating than recommended to avoid causing extensive damage to the electrical system and possibly a fire.

3. Turn the key to “ $\circ$ ” and turn on the electrical circuits to check if the devices operate.
4. If the fuse immediately blows again, have a Yamaha dealer check the electrical system.

# PERIODIC MAINTENANCE AND MINOR REPAIR

E AUS1400

## Replacing the headlight bulb

If the headlight bulb burns out, replace it as follows.

E CA10670

### CAUTION:

It is advisable to have a Yamaha dealer perform this job.

1. Place the scooter on the centerstand.
2. Remove cowling A. (See page 6-5.)
3. Disconnect the headlight coupler.

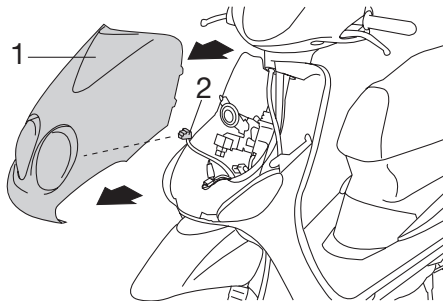

1. Cowling A
2. Headlight coupler

4. Remove the headlight bulb cover.

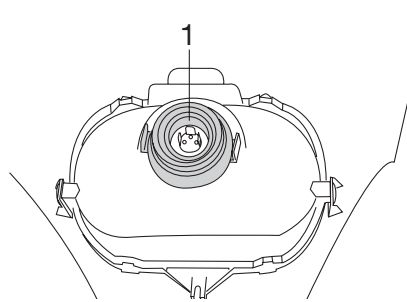

1. Headlight bulb cover

5. Unhook the headlight bulb holder, and then remove the defective bulb.

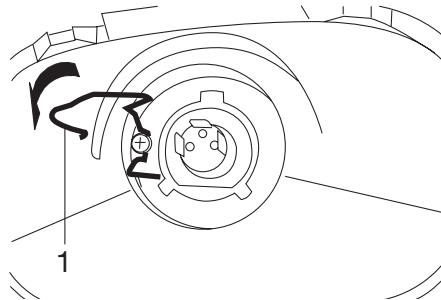

1. Headlight bulb holder

E WA10790

### WARNING

Headlight bulbs get very hot. Therefore, keep flammable products away from a lit headlight bulb, and do not touch the bulb until it has cooled down.

6. Place a new headlight bulb into position, and then secure it with the bulb holder.

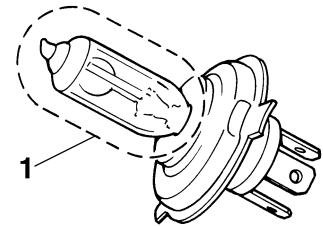

1. Do not touch the glass part of the bulb

### CAUTION:

Take care not to damage the following parts:

- Headlight bulb

E CA10650

# PERIODIC MAINTENANCE AND MINOR REPAIR

Do not touch the glass part of the headlight bulb to keep it free from oil, otherwise the transparency of the glass, the luminosity of the bulb, and the bulb life will be adversely affected. Thoroughly clean off any dirt and fingerprints on the headlight bulb using a cloth moistened with alcohol or thinner.

## ● Headlight lens

- Do not affix any type of tinted film or stickers to the headlight lens.
- Do not use a headlight bulb of a wattage higher than specified.

7. Install the headlight bulb cover.
8. Connect the headlight coupler.
9. Install the cowling.
10. Have a Yamaha dealer adjust the headlight beam if necessary.

## Replacing a front turn signal light bulb

EAUT1260

ECA10670

### CAUTION:

It is advisable to have a Yamaha dealer perform this job.

1. Place the scooter on the centerstand.
2. Remove cowling A. (See page 6-5.)
3. Remove the socket (together with the bulb) by turning it counterclockwise.

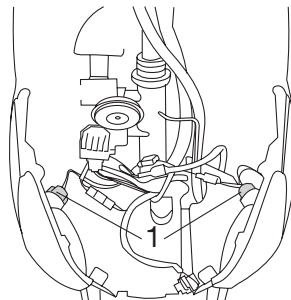

1. Turn signal light bulb socket

4. Remove the defective bulb by pushing it in and turning it counterclockwise.

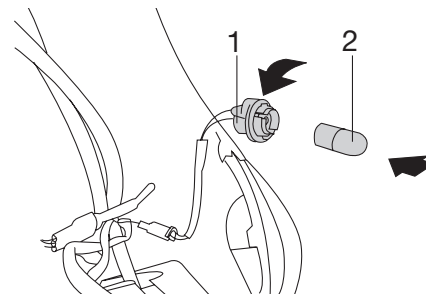

1. Turn signal light bulb socket
2. Front turn signal light bulb

5. Insert a new bulb into the socket, push it in, and then turn it clockwise until it stops.

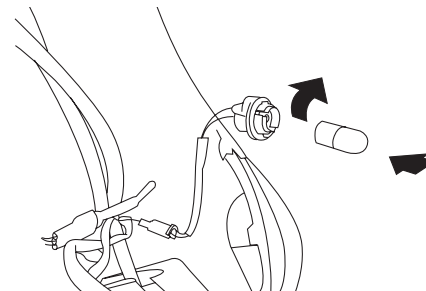

6. Install the socket (together with the bulb) by turning it clockwise.
7. Install the cowling.

# PERIODIC MAINTENANCE AND MINOR REPAIR

EAU24281

ECA10680

## Replacing a turn signal light bulb or the tail/brake light bulb

1. Remove the lens by removing the screws.

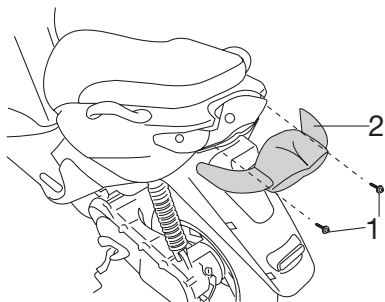

1. Screw
2. Lens

2. Remove the defective bulb by pushing it in and turning it counterclockwise.

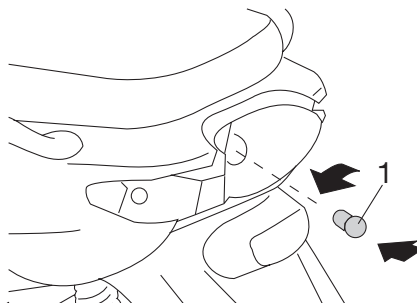

1. Tail/brake light bulb



1. Rear turn signal light bulb

3. Insert a new bulb into the socket, push it in, and then turn it clockwise until it stops.
4. Install the lens by installing the screws.

### CAUTION:

Do not overtighten the screws, otherwise the lens may break.

EAU25860

## Troubleshooting

Although Yamaha scooters receive a thorough inspection before shipment from the factory, trouble may occur during operation. Any problem in the fuel, compression, or ignition systems, for example, can cause poor starting and loss of power.

The following troubleshooting chart represents a quick and easy procedure for checking these vital systems yourself. However, should your scooter require any repair, take it to a Yamaha dealer, whose skilled technicians have the necessary tools, experience, and know-how to service the scooter properly.

Use only genuine Yamaha replacement parts. Imitation parts may look like Yamaha parts, but they are often inferior, have a shorter service life and can lead to expensive repair bills.

# PERIODIC MAINTENANCE AND MINOR REPAIR

EAU25962

## Troubleshooting chart

EWA10840

### **⚠ WARNING**

**Keep away open flames and do not smoke while checking or working on the fuel system.**

### 1. Fuel

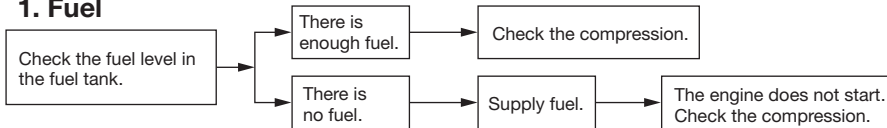

### 2. Compression

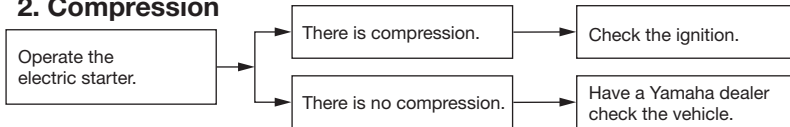

### 3. Ignition

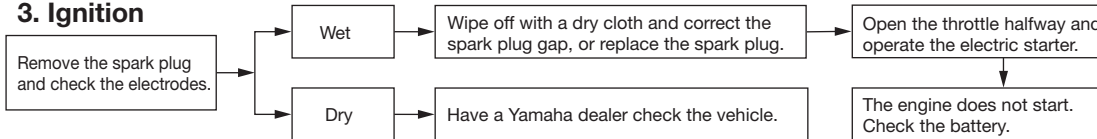

### 4. Battery

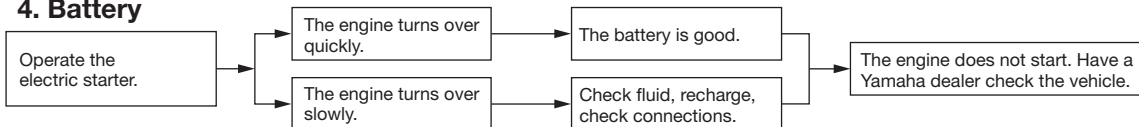



# SCOOTER CARE AND STORAGE

## Matte color caution

EAU37833

EAU26091

### CAUTION:

Some models are equipped with matte colored finished parts. Be sure to consult a Yamaha dealer for advice on what products to use before cleaning the vehicle. Using a brush, harsh chemical products or cleaning compounds when cleaning these parts will scratch or damage their surface. Wax also should not be applied to any matte colored finished parts.

ECA15192

## Care

While the open design of a scooter reveals the attractiveness of the technology, it also makes it more vulnerable. Rust and corrosion can develop even if high-quality components are used. A rusty exhaust pipe may go unnoticed on a car, however, it detracts from the overall appearance of a scooter. Frequent and proper care does not only comply with the terms of the warranty, but it will also keep your scooter looking good, extend its life and optimize its performance.

### Before cleaning

1. Cover the muffler outlet with a plastic bag after the engine has cooled down.
2. Make sure that all caps and covers as well as all electrical couplers and connectors, including the spark plug cap, are tightly installed.

3. Remove extremely stubborn dirt, like oil burnt onto the crankcase, with a degreasing agent and a brush, but never apply such products onto seals, gaskets and wheel axles. Always rinse the dirt and degreaser off with water.

### Cleaning

ECA10781

### CAUTION:

- Avoid using strong acidic wheel cleaners, especially on spoked wheels. If such products are used on hard-to-remove dirt, do not leave the cleaner on the affected area any longer than instructed. Also, thoroughly rinse the area off with water, immediately dry it, and then apply a corrosion protection spray.
- Improper cleaning can damage plastic parts such as cowlings, panels, windshields, headlight lenses, meter lenses, etc. Use only a soft, clean cloth or sponge with mild detergent and water to clean plastic.

# SCOOTER CARE AND STORAGE

---

- Do not use any harsh chemical products on plastic parts. Be sure to avoid using cloths or sponges which have been in contact with strong or abrasive cleaning products, solvent or thinner, fuel (gasoline), rust removers or inhibitors, brake fluid, antifreeze or electrolyte.
- Do not use high-pressure washers or steam-jet cleaners since they cause water seepage and deterioration in the following areas: seals (of wheel and swingarm bearings, fork and brakes), electric components (couplers, connectors, instruments, switches and lights), breather hoses and vents.

- For scooters equipped with a windshield: Do not use strong cleaners or hard sponges as they will cause dulling or scratching. Some cleaning compounds for plastic may leave scratches on the windshield. Test the product on a small hidden part of the windshield to make sure that it does not leave any marks. If the windshield is scratched, use a quality plastic polishing compound after washing.

---

### After normal use

Remove dirt with warm water, a mild detergent, and a soft, clean sponge, and then rinse thoroughly with clean water. Use a toothbrush or bottlebrush for hard-to-reach areas. Stubborn dirt and insects will come off more easily if the area is covered with a wet cloth for a few minutes before cleaning.

### After riding in the rain, near the sea or on salt-sprayed roads

Since sea salt or salt sprayed on the roads during winter are extremely corrosive in combination with water, carry out the following steps after each ride in the rain, near the sea or on salt-sprayed roads.

### **NOTE:** \_\_\_\_\_

Salt sprayed on roads in the winter may remain well into spring.

1. Clean the scooter with cold water and a mild detergent after the engine has cooled down.

ECA10790

### **CAUTION:** \_\_\_\_\_

**Do not use warm water since it increases the corrosive action of the salt.**

2. Apply a corrosion protection spray on all metal, including chrome- and nickel-plated, surfaces to prevent corrosion.

### **After cleaning**

1. Dry the scooter with a chamois or an absorbing cloth.

# SCOOTER CARE AND STORAGE

EAU26300

2. Use a chrome polish to shine chrome, aluminum and stainless-steel parts, including the exhaust system. (Even the thermally induced discoloring of stainless-steel exhaust systems can be removed through polishing.)
3. To prevent corrosion, it is recommended to apply a corrosion protection spray on all metal, including chrome- and nickel-plated, surfaces.
4. Use spray oil as a universal cleaner to remove any remaining dirt.
5. Touch up minor paint damage caused by stones, etc.
6. Wax all painted surfaces.
7. Let the scooter dry completely before storing or covering it.

EWA10940

## WARNING

- **Make sure that there is no oil or wax on the brakes or tires. If necessary, clean the brake discs and brake linings with a regular brake disc cleaner or acetone, and wash the tires with warm water and a mild detergent.**

- **Before operating the scooter test its braking performance and cornering behavior.**

ECA10800

## CAUTION:

- **Apply spray oil and wax sparingly and make sure to wipe off any excess.**
- **Never apply oil or wax to any rubber and plastic parts, but treat them with a suitable care product.**
- **Avoid using abrasive polishing compounds as they will wear away the paint.**

## NOTE:

Consult a Yamaha dealer for advice on what products to use.

## Storage Short-term

Always store your scooter in a cool, dry place and, if necessary, protect it against dust with a porous cover.

ECA10820

## CAUTION:

- **Storing the scooter in a poorly ventilated room or covering it with a tarp, while it is still wet, will allow water and humidity to seep in and cause rust.**
- **To prevent corrosion, avoid damp cellars, stables (because of the presence of ammonia) and areas where strong chemicals are stored.**

## Long-term

Before storing your scooter for several months:

1. Follow all the instructions in the “Care” section of this chapter.
2. Drain the carburetor float chamber by loosening the drain bolt; this will prevent fuel deposits from building up. Pour the drained fuel into the fuel tank.

# SCOOTER CARE AND STORAGE

---

EWA10950

## **WARNING**

**To prevent damage or injury from sparking, make sure to ground the spark plug electrodes while turning the engine over.**

---

3. Fill up the fuel tank and add fuel stabilizer (if available) to prevent the fuel tank from rusting and the fuel from deteriorating.
4. Perform the following steps to protect the cylinder, piston rings, etc. from corrosion.
  - a. Remove the spark plug cap and spark plug.
  - b. Pour a teaspoonful of engine oil into the spark plug bore.
  - c. Install the spark plug cap onto the spark plug, and then place the spark plug on the cylinder head so that the electrodes are grounded. (This will limit sparking during the next step.)
  - d. Turn the engine over several times with the starter. (This will coat the cylinder wall with oil.)
  - e. Remove the spark plug cap from the spark plug, and then install the spark plug and the spark plug cap.

5. Lubricate all control cables and the pivoting points of all levers and pedals as well as of the sidestand/centerstand.
6. Check and, if necessary, correct the tire air pressure, and then lift the scooter so that both of its wheels are off the ground. Alternatively, turn the wheels a little every month in order to prevent the tires from becoming degraded in one spot.
7. Cover the muffler outlet with a plastic bag to prevent moisture from entering it.

8. Remove the battery and fully charge it. Store it in a cool, dry place and charge it once a month. Do not store the battery in an excessively cold or warm place [less than 0 °C (30 °F) or more than 30 °C (90 °F)]. For more information on storing the battery, see page 6-17.

**NOTE:** \_\_\_\_\_  
Make any necessary repairs before storing the scooter.

---

# SPECIFICATIONS

## Dimensions:

- Overall length:  
1,840 mm (72.4 in)
- Overall width:  
770 mm (30.3 in)
- Overall height:  
1,245 mm (49.0 in)
- Seat height:  
793 mm (31.22 in)
- Wheelbase:  
1,275 mm (50.2 in)
- Ground clearance:  
153 mm (6.02 in)
- Minimum turning radius:  
3,880 mm (152.7 in)

## Weight:

- With oil and fuel:  
88 kg (194 lb)

## Engine:

- Engine type:  
Air cooled 2-stroke
- Cylinder arrangement:  
Forward-inclined single cylinder
- Displacement:  
49.2 cm x (2.99 cu.in)
- Bore x stroke:  
40.0 x 39.2 mm (1.57 x 1.54 in)
- Compression ratio:  
Std version: 11.0 :1  
Mofa version: 10.0 :1
- Starting system:  
Electric starter and kickstarter
- Lubrication system:  
Separate lubrication (Yamaha autolube)

## Engine oil:

- Type:  
YAMALUBE 2-cycle oil or 2-stroke engine oil (JASO FC grade) or (ISO EG-C or EG-D grade)

## Engine oil quantity:

- Quantity:  
1.5 L (1.59 US qt) (1.32 Imp.qt)

## Final transmission oil:

- Type:  
Yamalube 4 or SAE10W30 TYPE SE motor oil
- Quantity:  
0.11 L (0.12 US qt) (0.10 Imp.qt)

## Air filter:

- Air filter element:  
Wet element

## Fuel:

- Recommended fuel:  
Regular unleaded gasoline only
- Fuel tank capacity:  
6.1 L (1.61 US gal) (1.34 Imp.gal)
- Fuel reserve amount:  
1.4 L (0.37 US gal) (0.31 Imp.gal)

## Carburetor:

- Manufacturer:  
Gurtner
- Type x quantity:  
Std version: PY12 x 1  
Mofa version: PY12 x 1

## Spark plug(s):

- Manufacturer/model:  
Std version: NGK/BR8HS  
Mofa version: NGK/BPR4HS

## Spark plug gap:

- Std version: 0.6–0.7 mm (0.024–0.028 in)
- Mofa version: 0.6–0.7 mm (0.024–0.028 in)

## Clutch:

- Clutch type:  
Dry, centrifugal automatic

## Final transmission oil:

- Primary reduction system:  
Helical gear
- Primary reduction ratio:  
Std version: 52/13 (4.000)  
Mofa version: 52/12 (4.333)
- Secondary reduction system:  
Spur gear
- Secondary reduction ratio:  
Std version: 42/13 (3.230)  
Mofa version: 45/13 (3.461)
- Transmission type:  
V-belt automatic
- Operation:  
Centrifugal automatic type

## Chassis:

- Frame type:  
Steel tube underbone
- Caster angle:  
26.5 °
- Trail:  
92.6 mm (3.65 in)

## Front tire:

- Type:  
Tubeless
- Size:  
120/70 - 12 51L

# SPECIFICATIONS

---

Manufacturer/model:  
Vee Rubber  
Manufacturer/model:  
Continental / Zippy 1  
Manufacturer/model:  
Pirelli / SL26

## Rear tire:

Type:  
Tubeless  
Size:  
130/70 - 12 56L

Manufacturer/model:  
Vee Rubber  
Manufacturer/model:  
Continental / Zippy 1  
Manufacturer/model:  
Pirelli / SL26

## Loading:

Maximum load:  
163 kg (359 lb)  
(Total weight of rider, passenger, cargo  
and accessories)

## Tire air pressure (measured on cold tires):

Loading condition:  
0–90 kg (0–198 lb)  
Front:  
175 kPa (25 psi) (1.75 kgf/cm<sup>2</sup>)  
Rear:  
200 kPa (28 psi) (2.00 kgf/cm<sup>2</sup>)  
Loading condition:  
90 kg–163 kg (198 lb–359 lb)  
Front:  
175 kPa (25 psi) (1.75 kgf/cm<sup>2</sup>)

Rear:  
225 kPa (32 psi) (2.25 kgf/cm<sup>2</sup>)

## Front wheel:

Wheel type:  
Cast wheel  
Rim size:  
12xMT3.5

## Rear wheel:

Wheel type:  
Cast wheel  
Rim size:  
12xMT3.5

## Front brake:

Type:  
Single disc brake  
Operation:  
Right hand operation  
Recommended fluid:  
DOT 4

## Rear brake:

Type:  
Drum brake  
Operation:  
Left hand operation

## Front suspension:

Type:  
Telescopic fork  
Spring/shock absorber type:  
Coil spring/oil damper  
Wheel travel:  
70.0 mm (2.75 in)

## Rear suspension:

Type:  
Unit swing

Spring/shock absorber type:  
Coil spring/Oil damper  
Wheel travel:  
60.0 mm (2.36 in)

## Electrical system:

Ignition system:  
C.D.I.  
Charging system:  
Flywheel magneto

## Battery:

Model:  
YB 4L-B  
Voltage, capacity:  
12 V, 4.0 Ah

## Headlight:

Bulb type:  
Halogen bulb

## Bulb voltage, wattage x quantity:

Headlight:  
12 V, 35/35 W x 1  
Tail/brake light:  
12 V, 21/5 W x 1  
Front turn signal light:  
12 V, 10 W x 2  
Rear turn signal light:  
12 V, 10 W x 2  
Meter lighting:  
LED  
Oil level warning lamp  
LED  
High beam Indicator light  
LED  
Turn signal indicator light  
LED

Fuel level warning lamp  
LED

**Fuses:**

Main fuse:  
7.5 A

Backup fuse:  
7.5 A

# CONSUMER INFORMATION

EAU26351

## Identification numbers

Record the key identification number, vehicle identification number and model label information in the spaces provided below for assistance when ordering spare parts from a Yamaha dealer or for reference in case the vehicle is stolen.

KEY IDENTIFICATION NUMBER:

VEHICLE IDENTIFICATION NUMBER:

MODEL LABEL INFORMATION:

EAU26381

## Key identification number

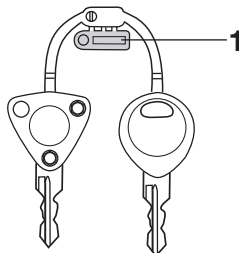

ZAUM0070

1. Key identification number

The key identification number is stamped into the key tag. Record this number in the space provided and use it for reference when ordering a new key.

EAU26410

## Vehicle identification number

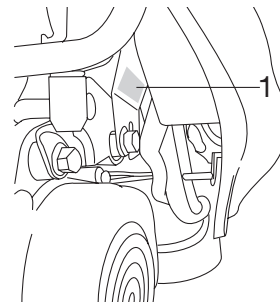

1. Vehicle identification number

The vehicle identification number is stamped into the frame.

**NOTE:** \_\_\_\_\_

The vehicle identification number is used to identify your motorcycle and may be used to register your motorcycle with the licensing authority in your area.

\_\_\_\_\_



EAU26490

## Model label

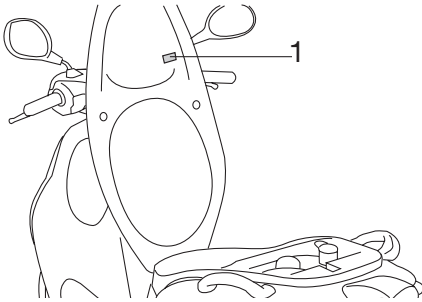

### 1. Model label

The model label is affixed to the bottom of the seat. (See page 3-9.) Record the information on this label in the space provided. This information will be needed when ordering spare parts from a Yamaha dealer.

# INDEX

---

- A**  
2-stroke engine oil .....3-8  
Acceleration and deceleration .....5-2  
Adjusting the throttle cable free play .....6-8  
Air filter element .....6-8  
Autolube pump, adjusting.....6-15
- B**  
Battery.....6-17  
Brake fluid level, checking .....6-13  
Brake fluid, changing .....6-14  
Brake lever, front.....3-6  
Brake lever, rear .....3-6  
Brake levers, lubricating .....6-15  
Brake pads and shoes, checking .....6-12  
Braking.....5-2
- C**  
Cables, checking and lubricating .....6-14  
Carburetor,adjusting.....6-8  
Care.....7-1  
Catalytic converter.....3-8  
Centerstand, checking and lubricating.....6-15  
Cowling and panel, removing and installing.....6-5
- D**  
Dimmer switch .....3-5
- E**  
Engine break-in.....5-3
- F**  
Final transmission oil .....6-7  
Front brake lever free play, checking.....6-11  
Front fork, checking .....6-16  
Fuel .....3-7  
Fuel and 2-stroke engine oil tank caps .....3-6  
Fuel consumption, tips for reducing.....5-3
- Fuel level warning light .....3-2  
Fuel tank breather/overflow hose .....3-8  
Fuse, replacing.....6-19
- H**  
Handlebar switches .....3-5  
Headlight bulb, replacing .....6-20  
High beam indicator light.....3-2  
Horn switch.....3-5
- I**  
Identification numbers .....9-1  
Indicator and warning lights .....3-2
- K**  
Key identification number .....9-1  
Kickstarter .....3-9
- L**  
Luggage hook .....3-11
- M**  
Main switch/steering lock .....3-1  
Matte color, caution .....7-1  
Model label .....9-2  
Multi-function display .....3-3
- O**  
Oil level warning light.....3-2
- P**  
Parking .....5-4  
Part locations .....2-1  
Periodic maintenance and lubrication chart.....6-2  
Pre-operation check list.....4-2
- R**  
Rear brake lever free play, adjusting .....6-11
- S**  
Safe-riding points.....1-4  
Safety information.....1-1
- Seat .....3-9  
Spark plug, checking .....6-6  
Specifications.....8-1  
Start switch .....3-5  
Starting a cold engine.....5-1  
Starting off .....5-2  
Steering, checking .....6-16  
Storage.....7-3  
Storage compartment.....3-10
- T**  
Throttle grip and cable, checking and lubricating .....6-14  
Tires .....6-9  
Troubleshooting .....6-23  
Troubleshooting chart .....6-24  
Turn signal indicator light.....3-2  
Turn signal light bulb (front), replacing ....6-21  
Turn signal light bulb or tail/brake light bulb, replacing .....6-22  
Turn signal switch .....3-5
- V**  
Vehicle identification number .....9-1
- W**  
Wheel bearings, checking.....6-17  
Wheels .....6-11





PRINTED IN NEEDEERLAND  
2007.03  
(E)