



**OWNER'S MANUAL**

**Fazer**

**FZS600  
FZS600SP  
5DM-28199-E3**

Welcome to the Yamaha world of motorcycling!

As the owner of a FZS600/FZS600SP, you are benefiting from Yamaha's vast experience in and newest technology for the design and the manufacture of high-quality products, which have earned Yamaha a reputation for dependability.

Please take the time to read this manual thoroughly, so as to enjoy all your FZS600/FZS600SP's advantages. The owner's manual does not only instruct you in how to operate, inspect and maintain your motorcycle, but also in how to safeguard yourself and others from trouble and injury.

In addition, the many tips given in this manual will help to keep your motorcycle in the best possible condition. If you have any further questions, do not hesitate to contact your Yamaha dealer.

The Yamaha team wishes you many safe and pleasant rides. So, remember to put safety first!

# IMPORTANT MANUAL INFORMATION

---

---

Particularly important information is distinguished in this manual by the following notations:



The Safety Alert Symbol means ATTENTION! BECOME ALERT! YOUR SAFETY IS INVOLVED!



Failure to follow **WARNING** instructions could result in severe injury or death to the motorcycle operator, a bystander or a person inspecting or repairing the motorcycle.

**CAUTION:**

A **CAUTION** indicates special precautions that must be taken to avoid damage to the motorcycle.

**NOTE:**

A **NOTE** provides key information to make procedures easier or clearer.

**NOTE:**

- This manual should be considered a permanent part of this motorcycle and should remain with it even if the motorcycle is subsequently sold.
  - Yamaha continually seeks advancements in product design and quality. Therefore, while this manual contains the most current product information available at the time of printing, there may be minor discrepancies between your motorcycle and this manual. If there is any question concerning this manual, please consult your Yamaha dealer.
-

# IMPORTANT MANUAL INFORMATION

---

---

EW000002

 **WARNING**

**PLEASE READ THIS MANUAL CAREFULLY AND COMPLETELY BEFORE OPERATING THIS MOTORCYCLE.**

---

# **IMPORTANT MANUAL INFORMATION**

---

---

EAU00008

**FZS600/FZS600SP  
OWNER'S MANUAL**

**© 1999 by Yamaha Motor Co., Ltd.**

**1st Edition, September 1999**

**All rights reserved. Any reprinting or  
unauthorized use without the written  
permission of Yamaha Motor Co., Ltd.  
is expressly prohibited.**

**Printed in Japan.**

1 GIVE SAFETY THE RIGHT OF WAY	1
2 DESCRIPTION	2
3 INSTRUMENT AND CONTROL FUNCTIONS	3
4 PRE-OPERATION CHECKS	4
5 OPERATION AND IMPORTANT RIDING POINTS	5
6 PERIODIC MAINTENANCE AND MINOR REPAIR	6
7 MOTORCYCLE CARE AND STORAGE	7
8 SPECIFICATIONS	8
9 CONSUMER INFORMATION	9
INDEX	





# GIVE SAFETY THE RIGHT OF WAY

---

---

GIVE SAFETY THE RIGHT OF WAY..... 1-1





# GIVE SAFETY THE RIGHT OF WAY

---

---

EAU00021

Motorcycles are fascinating vehicles, which can give you an unsurpassed feeling of power and freedom. However, they also impose certain limits, which you must accept; even the best motorcycle does not ignore the laws of physics.

Regular care and maintenance are essential for preserving your motorcycle's value and operating condition. Moreover, what is true for the motorcycle is also true for the rider: good performance depends on being in good shape. Riding under the influence of medication, drugs and alcohol is, of course, out of the question. Motorcycle riders - more than car drivers - must always be at their mental and physical best. Under the influence of even small amounts of alcohol, there is a tendency to take dangerous risks.

Protective clothing is as essential for the motorcycle rider as seat belts are for car drivers and passengers. Always wear a complete motorcycle suit (whether made of leather or tear-resistant synthetic materials with protectors), sturdy boots, motorcycle gloves and a properly fitting helmet. Optimum protective wear, however, should not encourage carelessness. Though full-coverage helmets and suits, in particular, create an illusion of total safety and protection, motorcyclists will always be vulnerable. Riders who lack critical self-control run the risk of going too fast and are apt to take chances. This is even more dangerous in wet weather. The good motorcyclist rides safely, predictably and defensively - avoiding all dangers, including those caused by others.

Enjoy your ride!

Left view .....	2-1
Right view.....	2-2
Controls/Instruments.....	2-3

## Left view

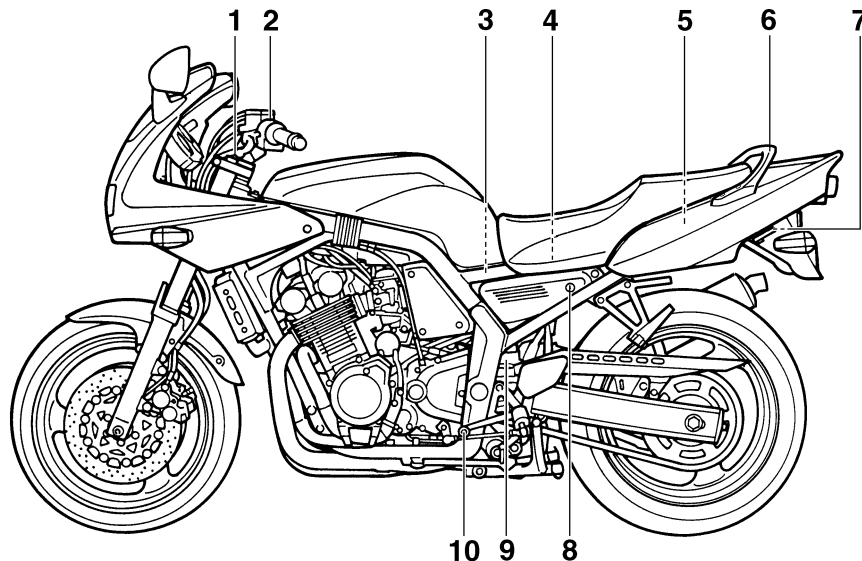

- |   |             |   |             |
|---|-------------|---|-------------|
| 1. Front fork spring preload adjusting bolt | (page 3-16) | 7. Luggage strap holder                                 | (page 3-17) |
| 2. Starter (choke) “  \”                    | (page 3-14) | 8. Seat lock  | (page 3-14) |
| 3. Air filter                               | (page 6-15) | 9. Rear shock absorber spring preload<br>adjusting ring | (page 3-17) |
| 4. Fuses                                    | (page 6-33) | 10. Shift pedal   | (page 3-11) |
| 5. Storage compartment                      | (page 3-15) |   |             |
| 6. Grab bar                                 |             |   |             |

## Right view

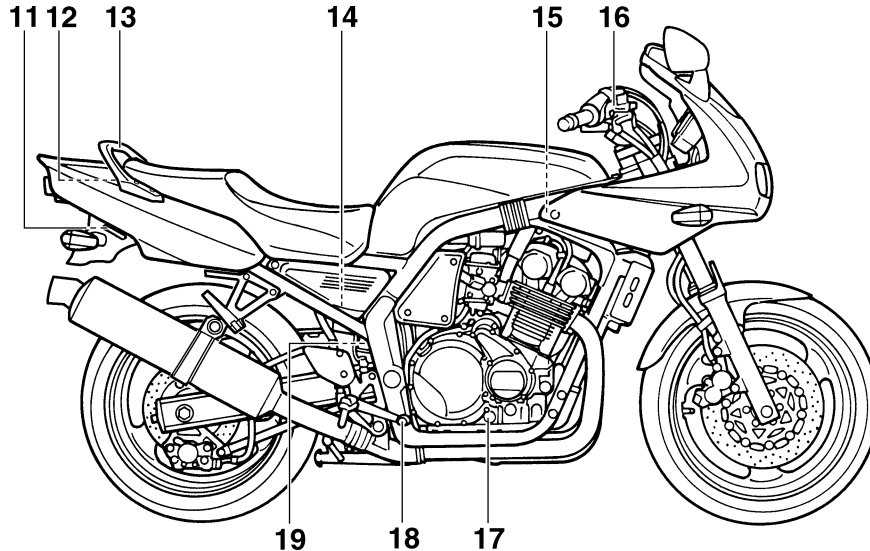

- |                                      |             |                                       |             |
|--------------------------------------|-------------|---------------------------------------|-------------|
| 11. Luggage strap holder             | (page 3-17) | 16. Front brake fluid master cylinder | (page 6-25) |
| 12. Tool kit                         | (page 6-1)  | 17. Oil level check window            | (page 6-9)  |
| 13. Grab bar                         |             | 18. Rear brake pedal                  | (page 3-11) |
| 14. Rear brake fluid master cylinder | (page 6-26) | 19. Coolant reservoir cap             | (page 6-13) |
| 15. Radiator cap                     | (page 6-14) |                                       |             |

# DESCRIPTION

---

---

## Controls/Instruments

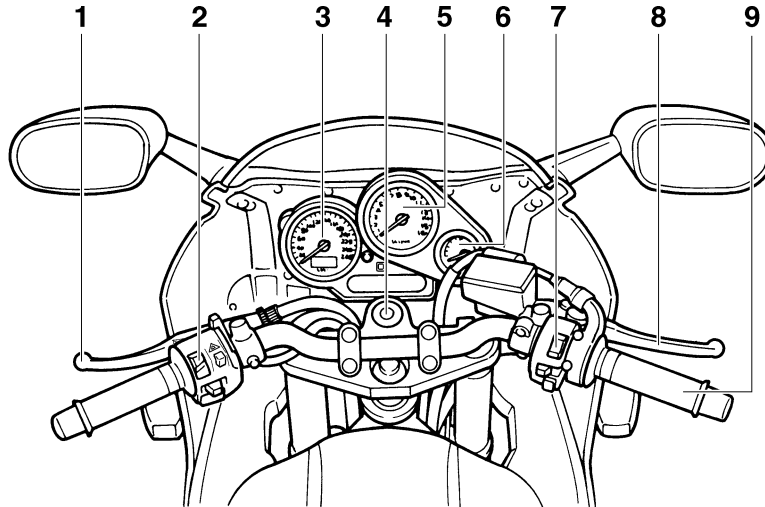

- |                             |             |
|-----------------------------|-------------|
| 1. Clutch lever             | (page 3-10) |
| 2. Left handlebar switches  | (page 3-9)  |
| 3. Speedometer              | (page 3-6)  |
| 4. Main switch              | (page 3-1)  |
| 5. Tachometer               | (page 3-7)  |
| 6. Fuel gauge               | (page 3-8)  |
| 7. Right handlebar switches | (page 3-10) |
| 8. Front brake lever        | (page 3-11) |
| 9. Throttle grip            | (page 6-19) |

# INSTRUMENT AND CONTROL FUNCTIONS

Main switch/Steering lock .....	3-1	Rear brake pedal.....	3-11
Indicator lights .....	3-3	Fuel tank cap .....	3-12
Oil level indicator circuit check.....	3-4	Fuel .....	3-13
Fuel indicator circuit check .....	3-5	Fuel tank breather hose .....	3-13
Speedometer .....	3-6	Starter (choke) “ ↘ ”.....	3-14
Tachometer .....	3-7	Seat.....	3-14
Diagnosis device.....	3-7	Helmet holder.....	3-15
Antitheft alarm (optional) .....	3-8	Storage compartment .....	3-15
Fuel gauge.....	3-8	Front fork adjustment .....	3-16
Handlebar switches .....	3-9	Rear shock absorber adjustment .....	3-17
Clutch lever .....	3-10	Luggage strap holders .....	3-17
Shift pedal.....	3-11	Sidestand .....	3-18
Front brake lever .....	3-11	Sidestand/clutch switch operation check.....	3-19

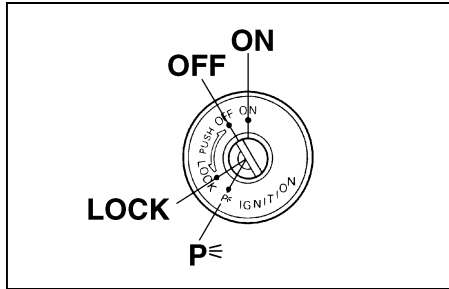

EAU00029

## Main switch/Steering lock

The main switch controls the ignition and lighting systems. Its operation is described below.

EAU00036

### ON

Electrical circuits are switched on. The engine can be started. The key cannot be removed in this position.

EAU00038

### OFF

All electrical circuits are switched off. The key can be removed in this position.

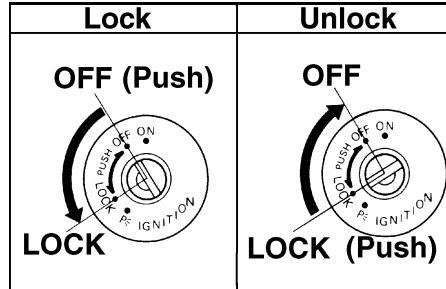

EAU00040

## LOCK

The steering is locked in this position and all electrical circuits are switched off. The key can be removed in this position. To lock the steering, turn the handlebars all the way to the left. While pushing the key into the main switch, turn it from "OFF" to "LOCK" and remove it. To release the lock, turn the key to "OFF" while pushing.

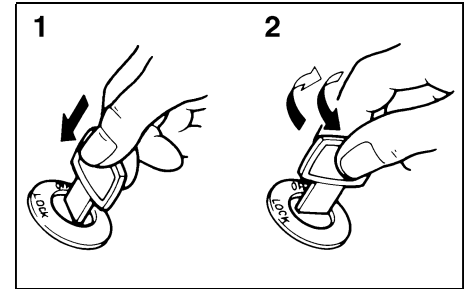

1. Push
2. Turn

EW000016

## **! WARNING**

**Never turn the key to "OFF" or "LOCK" when the motorcycle is moving. The electrical circuits will be switched off which may result in loss of control or an accident. Be sure the motorcycle is stopped before turning the key to "OFF" or "LOCK".**

EAU03013

## **P⊆ (Parking)**

The steering is locked in this position, and the taillights and auxiliary light come on but all other circuits are off. The key can be removed in this position.

To use the parking position, first lock the steering, then turn the key to “P⊆”.

Do not use this position for an extended length of time as the battery may discharge.



# INSTRUMENT AND CONTROL FUNCTIONS

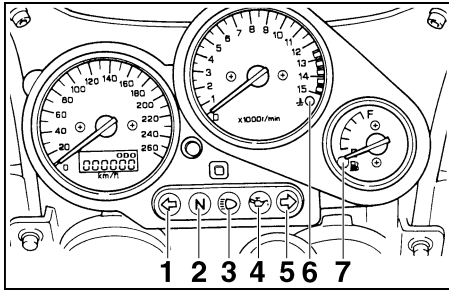

1. Left turn indicator light “←”
2. Neutral indicator light “N”
3. High beam indicator light “≡”
4. Oil level indicator light “”
5. Right turn indicator light “→”
6. Coolant temperature indicator light “”
7. Fuel indicator light “”

EAU00056

## Indicator lights

### Turn indicator lights “←” “→”

EAU00058

The corresponding indicator flashes when the turn switch is moved to the left or right.

### Neutral indicator light “N”

EAU00061

This indicator comes on when the transmission is in neutral.

EAU00063

### High beam indicator light “≡”

This indicator comes on when the headlight high beam is used.

EAU01313

### Oil level indicator light “”

This indicator comes on when the oil level is low. This light circuit can be checked by the procedure on page 3-4.

EC000000

#### CAUTION:

**Do not run the motorcycle until you know it has sufficient engine oil.**

#### NOTE:

Even if the oil is filled to the specified level, the indicator light may flicker when riding on a slope or during sudden acceleration or deceleration, but this is normal.

EAU01716

### Coolant temperature indicator light “”

This indicator light comes on when the engine overheats. If the light comes on, stop the engine immediately and allow the engine to cool.

EC000002

#### CAUTION:

**When the engine is overheated, do not continue riding.**

EAU01154

### Fuel indicator light “”

When the fuel level drops below approximately 3.5 L, this light will come on. When this light comes on, fill the tank at the first opportunity. This light circuit can be checked by the procedure on page 3-5.

# INSTRUMENT AND CONTROL FUNCTIONS

EAU00071

## Oil level indicator circuit check

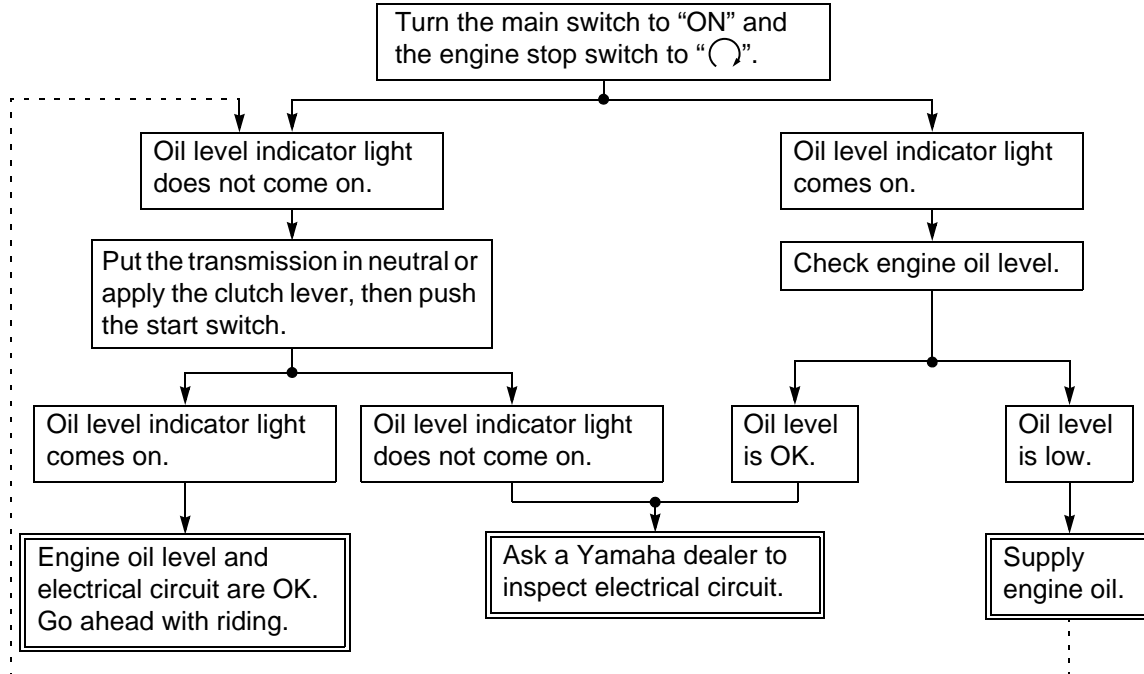

# INSTRUMENT AND CONTROL FUNCTIONS

EAU00085

## Fuel indicator circuit check

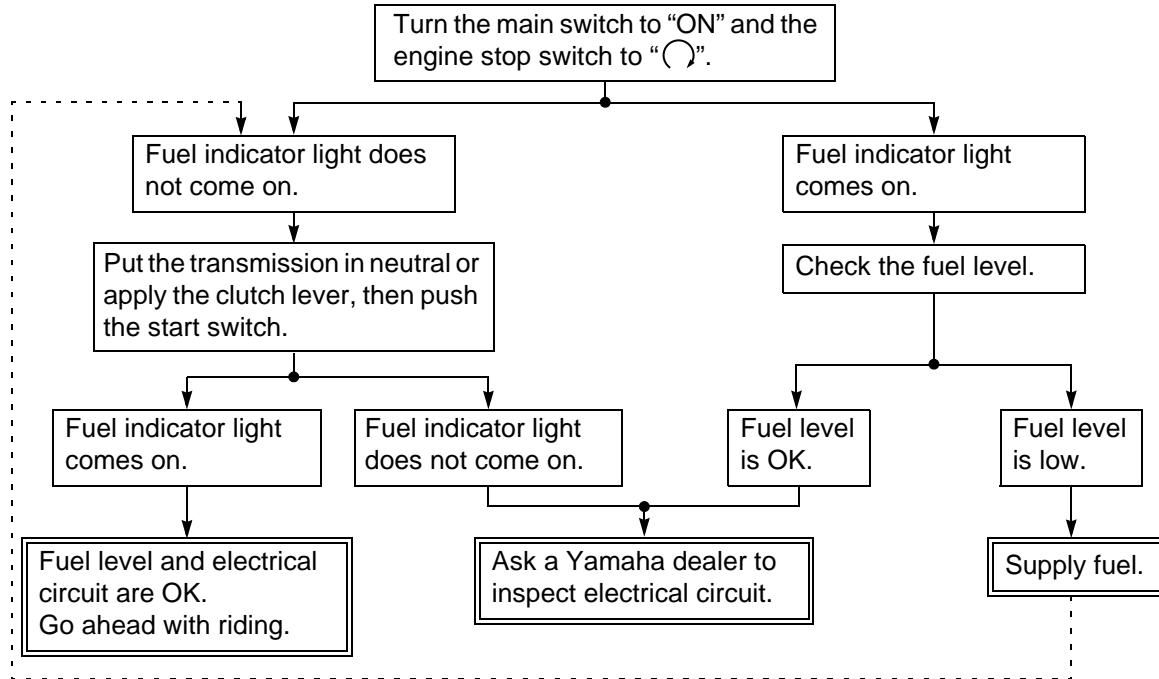

3

# INSTRUMENT AND CONTROL FUNCTIONS

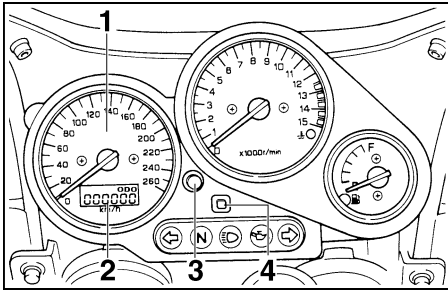

1. Speedometer
2. Odometer/Tripmeter/Clock
3. "SELECT" button
4. "RESET" button

EAU03028\*

## Speedometer

This speedometer is equipped with:

- an odometer
- two tripmeters
- a clock

## Odometer and tripmeter modes

When set to "ODO", the motorcycle's total mileage is indicated.

When set to "TRIP 1" or "TRIP 2", the motorcycle's mileage since the tripmeter was last reset is indicated. Use the tripmeters to estimate how far you can

ride on a tank of fuel. This information will enable you to plan fuel stops in the future.

## Selecting a mode

Push the "SELECT" button to change between the odometer mode "ODO", the tripmeter modes "TRIP 1" and "TRIP 2", and the clock mode in the following order:

"ODO" → "TRIP 1" → "TRIP 2" →  
Clock → "ODO"

## Resetting a meter

To reset either tripmeter 1 or 2 to 0.0, select either by pushing the "SELECT" button and push the "RESET" button for at least one second.

## Clock mode

To change the display to the clock mode, push the "SELECT" button.

To change the display back to the odometer mode, push the "SELECT" button.

## To set the clock

1. Push both the "SELECT" and "RESET" buttons for at least two seconds.
2. When the hour digits start flashing, push the "RESET" button to set the hours.
3. Push the "SELECT" button to change the minutes.
4. When the minute digits start flashing, push the "RESET" button to set the minutes.
5. Push the "SELECT" button to start the clock.

## NOTE:

After setting the clock, be sure to push the "SELECT" button before turning the main switch to "OFF", otherwise the clock will not be set.

# INSTRUMENT AND CONTROL FUNCTIONS

3

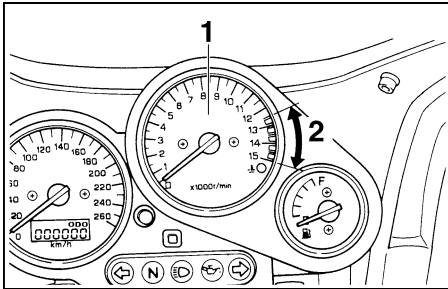

1. Tachometer
2. Red zone

EAU00101

## Tachometer

This model is equipped with an electric tachometer so the rider can monitor the engine speed and keep it within the ideal power range.

EC000003

### CAUTION:

Do not operate in the red zone.  
Red zone: 12,500 r/min and above

EAU01322\*

## Diagnosis device

This model is equipped with a diagnosis device for the Throttle Position Sensor (T.P.S.) circuit.

If some trouble should occur in the circuit, the tachometer will repeatedly display as follows:

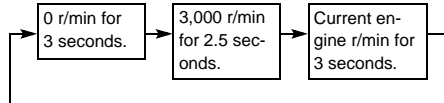

If the tachometer displays as described above, take your motorcycle to a Yamaha dealer for repair.

EC000004

### CAUTION:

To prevent engine damage, be sure to consult a Yamaha dealer as soon as possible if the tachometer displays a repeated change in r/min.

### NOTE:

If the tachometer should display 4,000 instead of 3,000 r/min, the speed sensor may be disconnected or short-circuited. In this case, ask a Yamaha dealer to inspect the motorcycle.

# INSTRUMENT AND CONTROL FUNCTIONS

## Antitheft alarm (optional)

EAU00109

An antitheft alarm can be equipped to this motorcycle. Consult your Yamaha dealer to obtain and install the alarm.

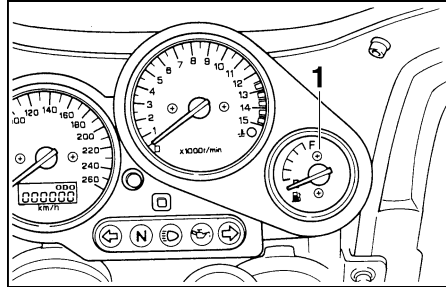

1. Fuel gauge

EAU00110

## Fuel gauge

This model is equipped with an electric fuel gauge so the rider can monitor the fuel level in the fuel tank. When the needle indicates “E” (Empty), about 3.5 L remain in the fuel tank.

# INSTRUMENT AND CONTROL FUNCTIONS

3

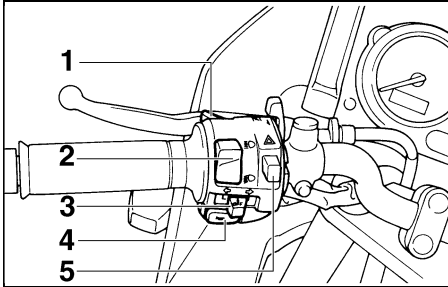

1. Pass switch "PASS"
2. Dimmer switch
3. Turn signal switch
4. Horn switch "📣"
5. Hazard switch "⚠️"

## Handlebar switches

EAU00118

### Pass switch "PASS"

Press the switch to operate the passing light.

EAU00120

### Dimmer switch

Turn the switch to "☰" for the high beam and to "☷" for the low beam.

EAU00121

EAU00127

### Turn signal switch

To signal a right-hand turn, push the switch to "➡️". To signal a left-hand turn, push the switch to "⬅️". Once the switch is released it will return to the center position. To cancel the signal, push the switch in after it has returned to the center position.

EAU00129

### Horn switch "📣"

Press the switch to sound the horn.

EAU00144

### Hazard switch "⚠️"

The hazard switch should be turned on under emergency or hazardous conditions. All turn signal lights will flash simultaneously when this switch is turned on with the main switch in the "ON" or "P" position.

EC000006

### CAUTION:

The battery can discharge from extended use, making it difficult to operate the starter.

### NOTE:

Turn on the hazard switch to warn other drivers if your motorcycle must be stopped where it might be a traffic hazard.

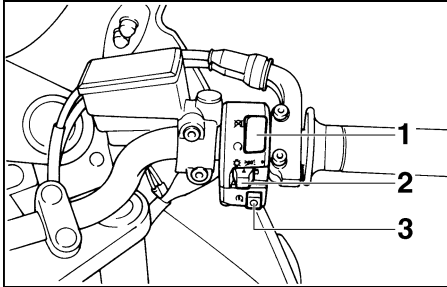

# INSTRUMENT AND CONTROL FUNCTIONS





1. Engine stop switch
2. Lights switch
3. Start switch “”

EAU00138

## Engine stop switch

The engine stop switch is a safety device for use in an emergency such as when the motorcycle overturns or if trouble occurs in the throttle system. Turn the switch to “” to start the engine. In case of emergency, turn the switch to “” to stop the engine.

## Lights switch

Turning the light switch to “”, turns on the auxiliary light, meter lights and taillight. Turning the light switch to “” turns the headlight on also.

EAU00134

## Start switch “”

The starter motor cranks the engine when pushing the start switch.

EAU00143

EC000005

## CAUTION:

**See starting instructions prior to starting the engine.**

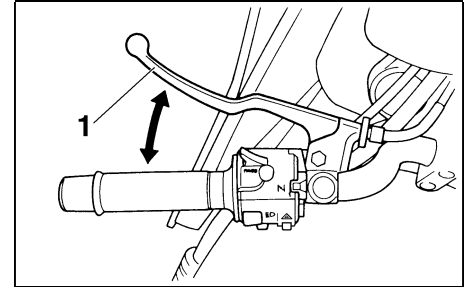

1. Clutch lever

EAU00152

## Clutch lever

The clutch lever is located on the left handlebar, and the ignition circuit cut-off system is incorporated in the clutch lever holder. Pull the clutch lever to the handlebar to disengage the clutch, and release the lever to engage the clutch. The lever should be pulled rapidly and released slowly for smooth clutch operation. (Refer to the engine starting procedures for a description of the ignition circuit cut-off system.)



# INSTRUMENT AND CONTROL FUNCTIONS

3

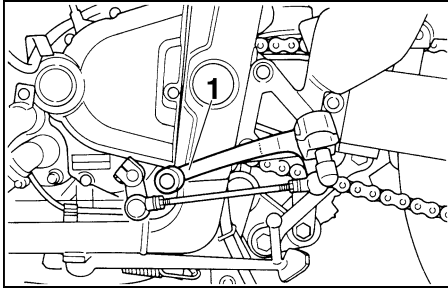

1. Shift pedal

EAU00157

## Shift pedal

This motorcycle is equipped with a constant-mesh 6-speed transmission.

The shift pedal is located on the left side of the engine and is used in combination with the clutch when shifting.

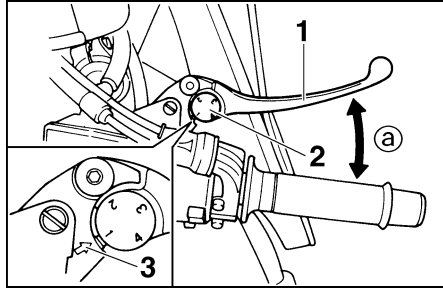

- 1. Front brake lever
- 2. Lever position adjuster
- 3. Arrow mark
- a. Lever distance

EAU00161

## Front brake lever

The front brake lever is located on the right handlebar and is equipped with a brake lever adjusting dial. To activate the front brake, pull the lever toward the handlebar. To adjust the front brake lever position, turn the brake lever adjusting dial while pulling the lever forward. Make sure the setting on the brake lever adjusting dial is aligned with the arrow mark.

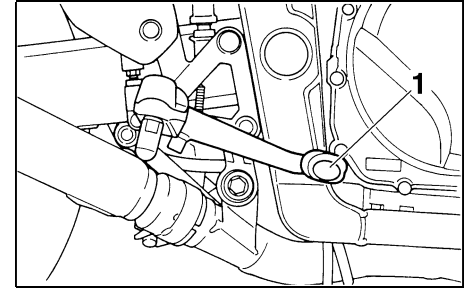

1. Rear brake pedal

EAU00162

## Rear brake pedal

The rear brake pedal is on the right side of the motorcycle. Press down on the brake pedal to apply the rear brake.

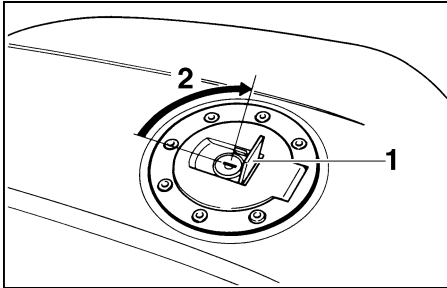

1. Lock cover
2. Open

EAU02935

## Fuel tank cap

### To open

Open the lock cover. Insert the key and turn it 1/4 turn clockwise. The lock will be released and the cap can be opened.

### To close

Push the tank cap into position with the key inserted. To remove the key, turn it counterclockwise to the original position. Then, close the lock cover.

**NOTE:** \_\_\_\_\_  
This tank cap cannot be closed unless the key is in the lock. The key cannot be removed if the cap is not locked properly.

EW000023

### **WARNING**

Be sure the cap is properly installed and locked in place before riding the motorcycle.

# INSTRUMENT AND CONTROL FUNCTIONS

3

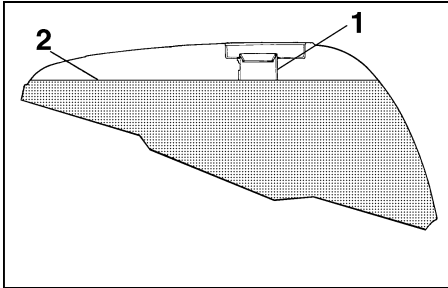

1. Filler tube
2. Fuel level

EAU001183

## Fuel

Make sure there is sufficient fuel in the tank. Fill the fuel tank to the bottom of the filler tube as shown in the illustration.

EW000130

## WARNING

**Do not overfill the fuel tank. Avoid spilling fuel on the hot engine. Do not fill the fuel tank above the bottom of the filler tube or it may overflow when the fuel heats up later and expands.**

EAU00185

## CAUTION:

**Always wipe off spilled fuel immediately with a dry and clean soft cloth. Fuel may deteriorate painted surfaces or plastic parts.**

EAU00191

## Recommended fuel:

Regular unleaded gasoline with a research octane number of 91 or higher.

## Fuel tank capacity:

Total:

20 L

Reserve:

3.5 L

## NOTE:

If knocking or pinging occurs, use a different brand of gasoline or higher octane grade.

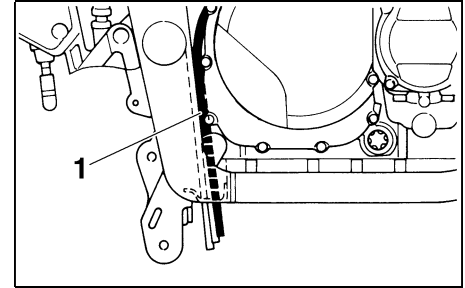

1. Fuel tank breather hose

EAU02955

## Fuel tank breather hose

This model is equipped with a fuel tank breather hose.

Before using this motorcycle:

- Check the fuel tank breather hose connection.
- Check the fuel tank breather hose for cracks or damage and replace it if damaged.
- Make sure the end of the fuel tank breather hose is not blocked and clean it if necessary.

# INSTRUMENT AND CONTROL FUNCTIONS

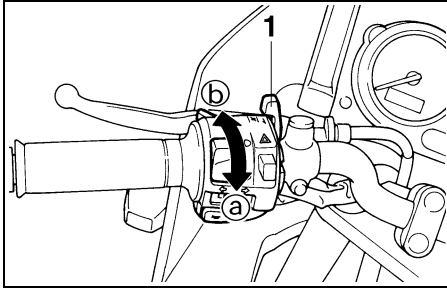

1. Starter (choke) “\”

EAU02976

## Starter (choke) “/”

Starting a cold engine requires a richer air-fuel mixture. A separate starter circuit supplies this mixture.

Move in direction ① to turn on the starter (choke).

Move in direction ② to turn off the starter (choke).

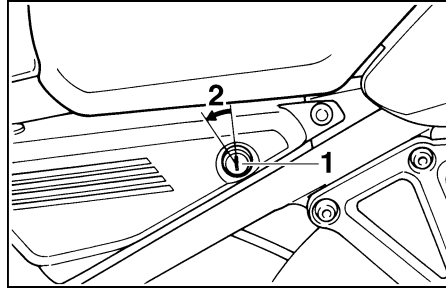

1. Seat lock  
2. Open

EAU01319

## Seat

### To remove

Insert the key into the seat lock and turn it counterclockwise. While holding the key in that position, lift up the front of the seat.

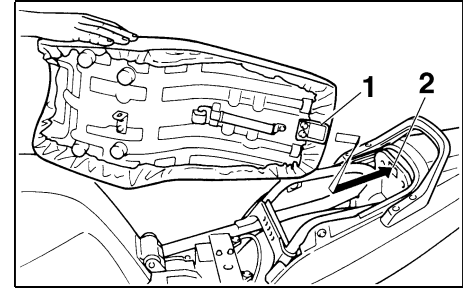

1. Projection  
2. Seat holder

### To install

Insert the projection on the rear of the seat into the seat holder, then push down on the front of the seat.

# INSTRUMENT AND CONTROL FUNCTIONS

3

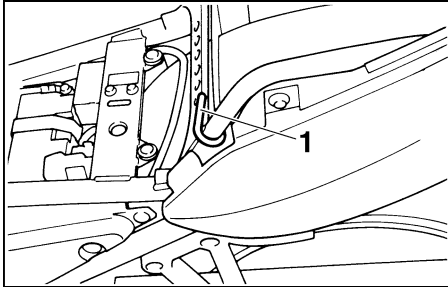

1. Helmet holder

EAU00263

## Helmet holder

The helmet holder is under the seat. Remove the seat and hook the helmet on the helmet holder. Then, reinstall the seat and lock it.

EW000030

### **WARNING**

**Never ride with a helmet in the helmet holder. The helmet may hit objects, causing loss of control and possibly an accident.**

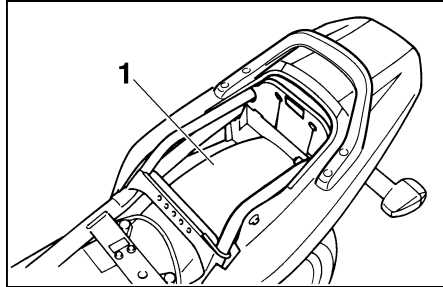

1. Storage compartment

EAU01688

## Storage compartment

This compartment is designed to store a genuine Yamaha U-LOCK. (Other locks may not fit.)

Be sure the lock is fastened securely with the straps when storing it in the compartment.

To prevent losing the straps, be sure to secure them even when a U-LOCK is not being stored in the compartment.

When storing this Owner's manual or other documents in the compartment, be sure to put them in a vinyl bag so they do not get wet. When washing the motorcycle, be careful not to flood this compartment with water.

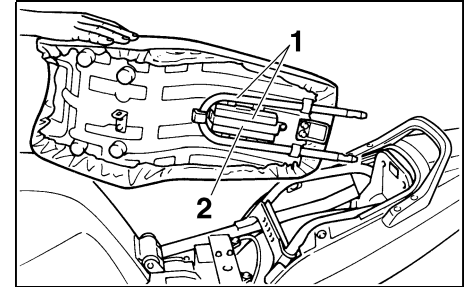

1. U-LOCK

2. Strap

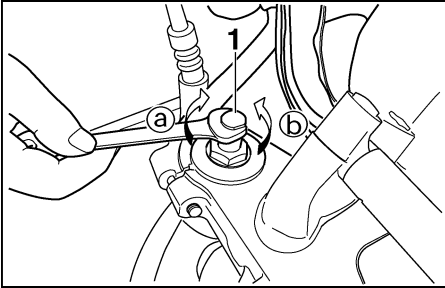

1. Spring preload adjusting bolt

EAU00285

## Front fork adjustment

This front fork is equipped with spring preload adjusting bolts.

EW000037

### **! WARNING**

Each fork leg must be set to the same pressure. Uneven setting can cause poor handling and loss of stability.

Adjust spring preload as follows. Turn the adjusting bolts in direction ① to increase spring preload and in direction ② to decrease spring preload.

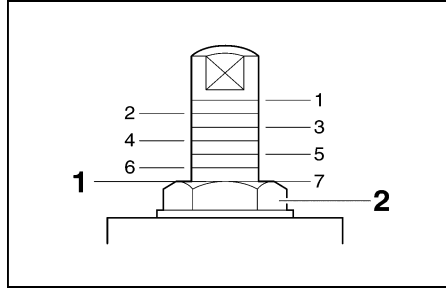

1. Setting position

2. Front fork cap

EC000013

### **CAUTION:**

The grooves are provided to show the adjustment level. Always keep the adjustment level equal on both fork legs.

	Hard				Standard	Soft	
Adjusting position	1	2	3	4	5	6	7

# INSTRUMENT AND CONTROL FUNCTIONS

3

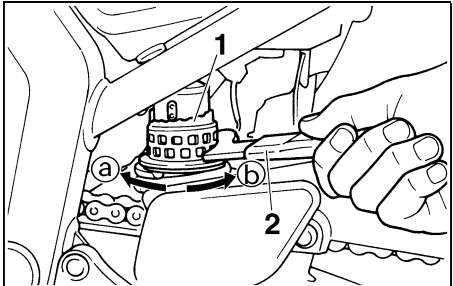

1. Spring preload adjusting ring
2. Special wrench

EAU00295

## Rear shock absorber adjustment

This shock absorber is equipped with a spring preload adjusting ring. Adjust spring preload as follows. Turn the adjusting ring in direction (a) to increase spring preload and in direction (b) to decrease spring preload. Make sure that the appropriate notch in the adjusting ring is aligned with the position indicator on the rear shock absorber.

	Hard					Standard	Soft			
Adjusting position	9	8	7	6	5	4	3	2	1	

EAU00315

### **⚠ WARNING**

This shock absorber contains highly pressurized nitrogen gas. Read and understand the following information before handling the shock absorber. The manufacturer cannot be held responsible for property damage or personal injury that may result from improper handling.

- Do not tamper with or attempt to open the cylinder assembly.
- Do not subject the shock absorber to an open flame or other high heat source. This may cause the unit to explode due to excessive gas pressure.
- Do not deform or damage the cylinder in any way. Cylinder damage will result in poor damping performance.
- Take your shock absorber to a Yamaha dealer for any service.

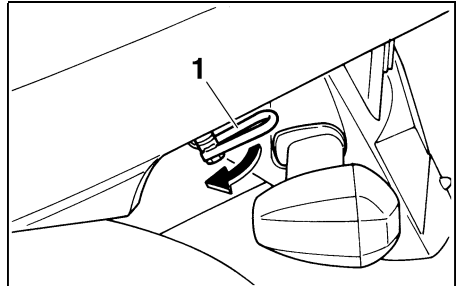

1. Luggage strap holder (x 2)

EAU01311

## Luggage strap holders

There are two luggage strap holders below the rear of the seat which can be turned outward for easier access.

EAU00330

EW000044

## Sidestand

This model is equipped with an ignition circuit cut-off system. The motorcycle must not be ridden when the sidestand is down. The sidestand is located on the left side of the frame. (Refer to page 5-1 for an explanation of this system.)

### **WARNING**

**This motorcycle must not be operated with the sidestand in the down position. If the stand is not properly retracted, it could contact the ground and distract the operator, resulting in a possible loss of control. Yamaha has designed into this motorcycle a lockout system to assist the operator in fulfilling the responsibility of retracting the sidestand. Please check carefully the operating instructions listed below and if there is any indication of a malfunction, return the motorcycle to a Yamaha dealer immediately for repair.**



# INSTRUMENT AND CONTROL FUNCTIONS

## Sidestand/clutch switch operation check

EAU00332

Check the operation of the sidestand switch and clutch switch against the information below.

EW000046

### WARNING

- Be sure to use the centerstand during this inspection.
- If improper operation is noted, consult a Yamaha dealer.

TURN MAIN SWITCH TO "ON" AND ENGINE STOP SWITCH TO "⏻".

TRANSMISSION IS IN GEAR AND SIDESTAND IS UP.

PULL IN CLUTCH LEVER AND PUSH START SWITCH.

ENGINE WILL START.

CLUTCH SWITCH IS OK.

SIDESTAND IS DOWN.

ENGINE WILL STALL.

SIDESTAND SWITCH IS OK.

Pre-operation check list..... 4-1

# PRE-OPERATION CHECKS

Owners are personally responsible for their vehicle's condition. Your motorcycle's vital functions can start to deteriorate quickly and unexpectedly, even if it remains unused (for instance, if it is exposed to the elements). Any damage, fluid leak or loss of tire pressure could have serious consequences. Therefore, it is very important that, in addition to a thorough visual inspection, you check the following points before each ride.

## PRE-OPERATION CHECK LIST

ITEM	CHECKS	PAGE
Front brake	<ul style="list-style-type: none"><li>• Check operation, free play, fluid level and fluid leakage.</li><li>• Fill with DOT 4 brake fluid if necessary.</li></ul>	6-24 ~ 6-26
Rear brake		
Clutch	<ul style="list-style-type: none"><li>• Check operation condition and free play.</li><li>• Adjust if necessary.</li></ul>	6-23
Throttle grip and housing	<ul style="list-style-type: none"><li>• Check for smooth operation.</li><li>• Lubricate if necessary.</li></ul>	6-19, 6-28
Engine oil	<ul style="list-style-type: none"><li>• Check oil level.</li><li>• Fill with oil if necessary.</li></ul>	6-9 ~ 6-11
Coolant reservoir tank	<ul style="list-style-type: none"><li>• Check coolant level.</li><li>• Fill with coolant if necessary.</li></ul>	6-12 ~ 6-15
Drive chain	<ul style="list-style-type: none"><li>• Check chain slack and condition.</li><li>• Adjust if necessary.</li></ul>	6-27 ~ 6-28
Wheels and tires	<ul style="list-style-type: none"><li>• Check tire pressure, wear and damage.</li></ul>	6-19 ~ 6-22 6-35 ~ 6-38
Control cables	<ul style="list-style-type: none"><li>• Check for smooth operation.</li><li>• Lubricate if necessary.</li></ul>	6-28
Brake and shift pedal shafts	<ul style="list-style-type: none"><li>• Check for smooth operation.</li><li>• Lubricate if necessary.</li></ul>	6-29
Brake and clutch lever pivots	<ul style="list-style-type: none"><li>• Check for smooth operation.</li><li>• Lubricate if necessary.</li></ul>	6-29

# PRE-OPERATION CHECKS

ITEM	CHECKS	PAGE
<b>Center and sidestand pivots</b>	<ul style="list-style-type: none"><li>• Check for smooth operation.</li><li>• Lubricate if necessary.</li></ul>	6-29
<b>Chassis fasteners</b>	<ul style="list-style-type: none"><li>• Make sure that all nuts, bolts and screws are properly tightened.</li><li>• Tighten if necessary.</li></ul>	—
<b>Fuel</b>	<ul style="list-style-type: none"><li>• Check fuel level.</li><li>• Fill with fuel if necessary.</li></ul>	3-12 ~ 3-13
<b>Lights, signals and switches</b>	<ul style="list-style-type: none"><li>• Check for proper operation.</li></ul>	6-33 ~ 6-35

**NOTE:** \_\_\_\_\_  
Pre-operation checks should be made each time the motorcycle is used. Such an inspection can be thoroughly accomplished in a very short time; and the added safety it assures is more than worth the time involved.

 **WARNING**

**If any item in the PRE-OPERATION CHECK is not working properly, have it inspected and repaired before operating the motorcycle.**



# OPERATION AND IMPORTANT RIDING POINTS

---

Starting the engine .....	5-1
Starting a warm engine .....	5-4
Shifting .....	5-4
Recommended shift points (for Switzerland only) .....	5-5
Tips for reducing fuel consumption .....	5-5
Engine break-in .....	5-5
Parking .....	5-6

EAU00373

EAU01627\*

**! WARNING**

- Before riding this motorcycle, become thoroughly familiar with all operating controls and their functions. Consult a Yamaha dealer regarding any control or function that you do not thoroughly understand.
- Never start your engine or let it run for any length of time in a closed area. The exhaust fumes are poisonous and can cause loss of consciousness and death within a short time. Always operate your motorcycle in an area with adequate ventilation.
- Before starting out, always be sure the sidestand is up. Failure to retract the sidestand completely can result in a serious accident when you try to turn a corner.

## Starting the engine

**NOTE:**

This motorcycle is equipped with an ignition circuit cut-off system.

The engine can be started only under one of the following conditions:

- The transmission is in neutral.
- The sidestand is up, the transmission is in gear and the clutch is disengaged.

The motorcycle must not be ridden when the sidestand is down.

EW000054

**! WARNING**

Before going through the following steps, check the function of the sidestand switch and clutch switch. (Refer to page 3-19.)

# OPERATION AND IMPORTANT RIDING POINTS

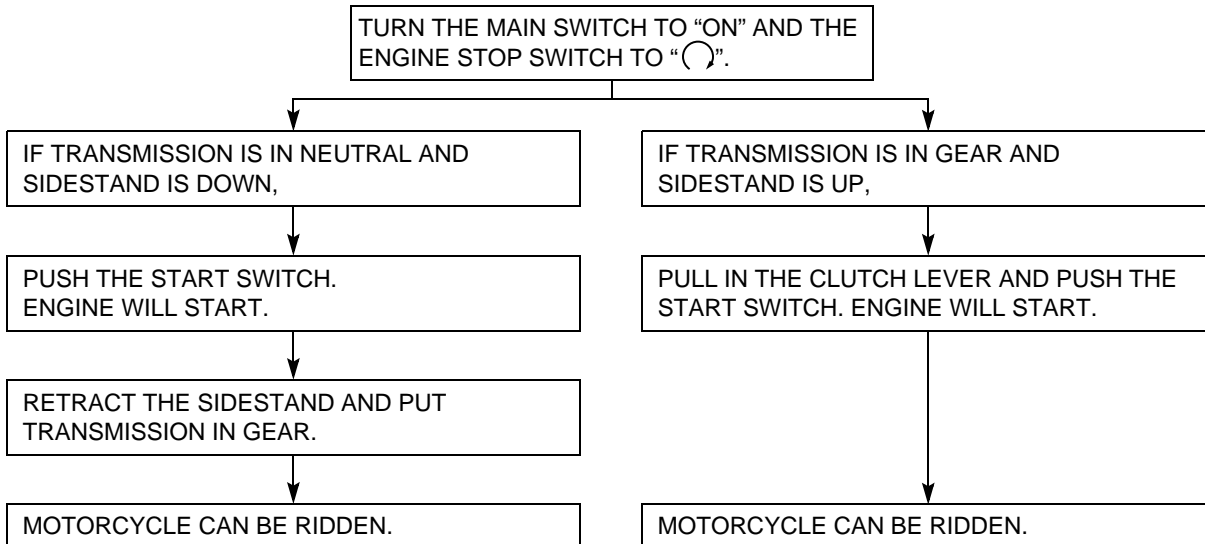



# OPERATION AND IMPORTANT RIDING POINTS

---

---

1. Turn the main switch to “ON” and the engine stop switch to “”.

EC000035

**CAUTION:** \_\_\_\_\_

**If the fuel indicator light comes on, check the fuel level. If necessary, fill the tank with fuel.**

---

2. Shift the transmission into neutral.

**NOTE:** \_\_\_\_\_

When the transmission is in neutral, the neutral indicator light should be on. If the light does not come on, ask a Yamaha dealer to inspect it.

---

3. Turn on the starter (choke) and completely close the throttle grip.
4. Start the engine by pushing the start switch.

**NOTE:** \_\_\_\_\_

If the engine fails to start, release the start switch, wait a few seconds, then try again. Each attempt should be as short as possible to preserve the battery. Do not crank the engine more than 10 seconds on any one attempt.

---

EC000036

**CAUTION:** \_\_\_\_\_

**The oil level indicator light and fuel indicator light should come on when the start switch is pushed and should go off when the start switch is released. If the oil level indicator light flickers or remains on, immediately stop the engine and check the engine oil level and for oil leakage. If necessary, fill the engine with oil and check to see that the oil level indicator light goes off. If not, consult a Yamaha dealer.**

---

5. After starting the engine, move the starter (choke) to the halfway position.

**NOTE:** \_\_\_\_\_

For maximum engine life, never accelerate hard with a cold engine!

---

6. After the engine is warm, turn off the starter (choke) completely.

**NOTE:** \_\_\_\_\_

The engine is warm when it responds normally to the throttle with the starter (choke) turned off.

---

## Starting a warm engine

EAU01258

The starter (choke) is not required when the engine is warm.

EC000046

### CAUTION:

See the “Engine break-in” section prior to operating the motorcycle for the first time.

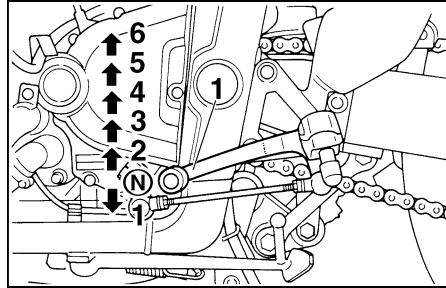

- 1. Shift pedal
- N. Neutral

EAU00423

## Shifting

The transmission lets you control the amount of power you have available at a given speed for starting, accelerating, climbing hills, etc. The use of the shift pedal is shown in the illustration.

To shift into neutral, depress the shift pedal repeatedly until it reaches the end of its travel, then raise the pedal slightly.

EC000048

### CAUTION:

- Do not coast for long periods with the engine off, and do not tow the motorcycle a long distance. Even with gears in neutral, the transmission is only properly lubricated when the engine is running. Inadequate lubrication may damage the transmission.
- Always use the clutch when changing gears. The engine, transmission, and driveline are not designed to withstand the shock of forced shifting and can be damaged by shifting without using the clutch.

# OPERATION AND IMPORTANT RIDING POINTS

EAU02937

## Recommended shift points (for Switzerland only)

The recommended shift points are shown in the table below.

	Acceleration shift point (km/h)
1st → 2nd	20
2nd → 3rd	30
3rd → 4th	40
4th → 5th	50
5th → 6th	60

**NOTE:** \_\_\_\_\_  
When shifting two gears down from 5th to 3rd, bring your motorcycle to a speed of 35 km/h.

EAU00424

## Tips for reducing fuel consumption

Your motorcycle's fuel consumption depends to a large extent on your riding style. The following tips can help reduce fuel consumption:

- Warm up the engine before riding.
- Turn off the starter (choke) as soon as possible.
- Shift up swiftly and avoid high engine speeds during acceleration.
- Do not double-clutch or rev the engine while shifting down and avoid high engine speeds with no load on the engine.
- Turn off the engine instead of letting it idle for an extended length of time, i.e. in traffic jams, at traffic lights or railroad crossings.

EAU01128

## Engine break-in

There is never a more important period in the life of your motorcycle than the period between zero and 1,600 km. For this reason we ask that you carefully read the following material. Because the engine is brand new, you must not put an excessive load on it for the first 1,600 km. The various parts in the engine wear and polish themselves to the correct operating clearances. During this period, prolonged full throttle operation, or any condition which might result in excessive heating of the engine, must be avoided.

# OPERATION AND IMPORTANT RIDING POINTS

## 0 ~ 1,000 km

EAU01329

Avoid operation above 5,000 r/min.

## 1,000 ~ 1,600 km

Avoid cruising speeds in excess of 6,000 r/min.

EC000052

### CAUTION:

After 1,000 km of operation, be sure to replace the engine oil and oil filter.

## 1,600 km and beyond

Proceed with normal riding.

EC000053

### CAUTION:

- Never let engine speeds enter the red zone.
- If any engine trouble should occur during the break-in period, consult a Yamaha dealer immediately.

## Parking

EAU00460

When parking the motorcycle, stop the engine and remove the ignition key.

EW000058

### WARNING

The exhaust system is hot. Park the motorcycle in a place where pedestrians or children are not likely to touch the motorcycle. Do not park the motorcycle on a slope or soft ground; the motorcycle may overturn.



# PERIODIC MAINTENANCE AND MINOR REPAIR

Tool kit.....	6-1	Drive chain slack adjustment .....	6-27
Periodic maintenance and lubrication.....	6-2	Drive chain lubrication.....	6-28
Panel removal and installation .....	6-5	Cable inspection and lubrication .....	6-28
Panel A, C.....	6-5	Throttle cable and grip lubrication .....	6-28
Panel B .....	6-6	Brake and shift pedal lubrication .....	6-29
Spark plugs.....	6-7	Brake and clutch lever lubrication .....	6-29
Engine oil .....	6-9	Center and sidestand lubrication .....	6-29
Cooling system .....	6-12	Rear suspension lubrication.....	6-30
Changing the coolant.....	6-13	Front fork inspection.....	6-30
Air filter .....	6-15	Steering inspection .....	6-31
Carburetor adjustment .....	6-18	Wheel bearings .....	6-31
Idle speed adjustment .....	6-18	Battery.....	6-31
Throttle cable free play inspection .....	6-19	Fuse replacement .....	6-33
Valve clearance adjustment.....	6-19	Headlight bulb replacement .....	6-33
Tires.....	6-19	Taillight bulb replacement.....	6-35
Wheels.....	6-22	Turn signal light bulb replacement.....	6-35
Clutch lever free play adjustment.....	6-23	Front wheel removal.....	6-35
Rear brake pedal height check .....	6-23	Front wheel installation .....	6-36
Brake light switch adjustment .....	6-24	Rear wheel removal .....	6-37
Checking the front and rear brake pads.....	6-25	Rear wheel installation.....	6-38
Inspecting the brake fluid level.....	6-25	Troubleshooting .....	6-39
Brake fluid replacement .....	6-26	Troubleshooting chart.....	6-40
Drive chain slack check .....	6-27		

EAU00464

Periodic inspection, adjustment and lubrication will keep your motorcycle in the safest and most efficient condition possible. Safety is an obligation of the motorcycle owner. The maintenance and lubrication schedule chart should be considered strictly as a guide to general maintenance and lubrication intervals. YOU MUST TAKE INTO CONSIDERATION THAT WEATHER, TERRAIN, GEOGRAPHICAL LOCATIONS, AND A VARIETY OF INDIVIDUAL USES ALL TEND TO DEMAND THAT EACH OWNER ALTER THIS TIME SCHEDULE TO SHORTER INTERVALS TO MATCH THE ENVIRONMENT. The most important points of motorcycle inspection, adjustment, and lubrication are explained in the following pages.

EW000060

**⚠ WARNING**

If you are not familiar with motorcycle service, this work should be done by a Yamaha dealer.

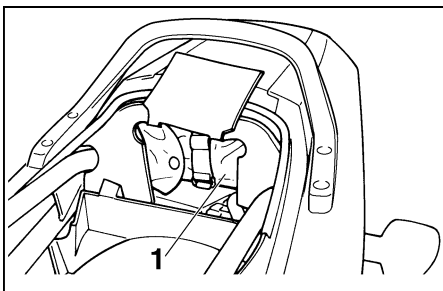

1. Tool kit

EAU01299

## Tool kit

The tool kit is located inside the storage compartment under the seat. (See page 3-14 for seat opening procedures.) The tools provided in the owner's tool kit are to assist you in the performance of periodic maintenance. However, some other tools such as a torque wrench are also necessary to perform the maintenance correctly.

The service information included in this manual is intended to provide you, the owner, with the necessary information for completing some of your own preventive maintenance and minor repairs.

**NOTE:**

If you do not have necessary tools required during a service operation, take your motorcycle to a Yamaha dealer for service.

EW000063

**⚠ WARNING**

Modifications to this motorcycle not approved by Yamaha may cause loss of performance, and render it unsafe for use. Consult a Yamaha dealer before attempting any changes.

# PERIODIC MAINTENANCE AND MINOR REPAIR

EAU00473

## PERIODIC MAINTENANCE AND LUBRICATION

NO.	ITEM	CHECKS AND MAINTENANCE JOBS	INITIAL (1,000 km)	EVERY	
				6,000 km or 6 months (whichever comes first)	12,000 km or 12 months (whichever comes first)
1	* Fuel line	<ul style="list-style-type: none"> <li>• Check fuel hoses for cracks or damage.</li> <li>• Replace if necessary.</li> </ul>		√	√
2	* Fuel filter	<ul style="list-style-type: none"> <li>• Check condition.</li> <li>• Replace if necessary.</li> </ul>			√
3	Spark plugs	<ul style="list-style-type: none"> <li>• Check condition.</li> <li>• Clean, regap or replace if necessary.</li> </ul>	√	√	√
4	* Valves	<ul style="list-style-type: none"> <li>• Check valve clearance.</li> <li>• Adjust if necessary.</li> </ul>	Every 42,000 km or 42 months (whichever comes first)		
5	Air filter	<ul style="list-style-type: none"> <li>• Clean or replace if necessary.</li> </ul>		√	√
6	Clutch	<ul style="list-style-type: none"> <li>• Check operation.</li> <li>• Adjust or replace cable.</li> </ul>	√	√	√
7	* Front brake	<ul style="list-style-type: none"> <li>• Check operation, fluid level and vehicle for fluid leakage. (See NOTE on page 6-4.)</li> <li>• Correct accordingly.</li> <li>• Replace brake pads if necessary.</li> </ul>	√	√	√
8	* Rear brake	<ul style="list-style-type: none"> <li>• Check operation, fluid level and vehicle for fluid leakage. (See NOTE on page 6-4.)</li> <li>• Correct accordingly.</li> <li>• Replace brake pads if necessary.</li> </ul>	√	√	√
9	* Wheels	<ul style="list-style-type: none"> <li>• Check balance, runout and for damage.</li> <li>• Rebalance or replace if necessary.</li> </ul>		√	√
10	* Tires	<ul style="list-style-type: none"> <li>• Check tread depth and for damage.</li> <li>• Replace if necessary.</li> <li>• Check air pressure.</li> <li>• Correct if necessary.</li> </ul>		√	√



# PERIODIC MAINTENANCE AND MINOR REPAIR

NO.	ITEM	CHECKS AND MAINTENANCE JOBS	INITIAL (1,000 km)	EVERY	
				6,000 km or 6 months (whichever comes first)	12,000 km or 12 months (whichever comes first)
11	* Wheel bearings	<ul style="list-style-type: none"> <li>• Check bearing for looseness or damage.</li> <li>• Replace if necessary.</li> </ul>		√	√
12	* Swingarm	<ul style="list-style-type: none"> <li>• Check swingarm pivoting point for play.</li> <li>• Correct if necessary.</li> <li>• Lubricate with molybdenum disulfide grease every 24,000 km or 24 months (whichever comes first).</li> </ul>		√	√
13	Drive chain	<ul style="list-style-type: none"> <li>• Check chain slack.</li> <li>• Adjust if necessary. Make sure that the rear wheel is properly aligned.</li> <li>• Clean and lubricate.</li> </ul>	Every 1,000 km and after washing the motorcycle or riding in the rain		
14	* Steering bearings	<ul style="list-style-type: none"> <li>• Check bearing play and steering for roughness.</li> <li>• Correct accordingly.</li> <li>• Lubricate with lithium soap base grease every 24,000 km or 24 months (whichever comes first).</li> </ul>		√	√
15	* Chassis fasteners	<ul style="list-style-type: none"> <li>• Make sure that all nuts, bolts and screws are properly tightened.</li> <li>• Tighten if necessary.</li> </ul>		√	√
16	Sidestand/centerstand	<ul style="list-style-type: none"> <li>• Check operation.</li> <li>• Lubricate and repair if necessary.</li> </ul>		√	√
17	* Sidestand switch	<ul style="list-style-type: none"> <li>• Check operation.</li> <li>• Replace if necessary.</li> </ul>	√	√	√
18	* Front fork	<ul style="list-style-type: none"> <li>• Check operation and for oil leakage.</li> <li>• Correct accordingly.</li> </ul>		√	√
19	* Rear shock absorber assembly	<ul style="list-style-type: none"> <li>• Check operation and shock absorber for oil leakage.</li> <li>• Replace shock absorber assembly if necessary.</li> </ul>		√	√
20	* Rear suspension relay arm and connecting arm pivoting points	<ul style="list-style-type: none"> <li>• Check operation.</li> <li>• Lubricate with molybdenum disulfide grease every 24,000 km or 24 months (whichever comes first).</li> </ul>		√	√

# PERIODIC MAINTENANCE AND MINOR REPAIR

NO.	ITEM	CHECKS AND MAINTENANCE JOBS	INITIAL (1,000 km)	EVERY	
				6,000 km or 6 months (whichever comes first)	12,000 km or 12 months (whichever comes first)
21	* Carburetors	<ul style="list-style-type: none"> <li>• Check engine idling speed, synchronization and starter operation.</li> <li>• Adjust if necessary.</li> </ul>	√	√	√
22	Engine oil	<ul style="list-style-type: none"> <li>• Check oil level and vehicle for oil leakage.</li> <li>• Correct if necessary.</li> <li>• Change. (Warm engine before draining.)</li> </ul>	√	√	√
23	Engine oil filter cartridge	<ul style="list-style-type: none"> <li>• Replace.</li> </ul>	√		√
24	* Cooling system	<ul style="list-style-type: none"> <li>• Check coolant level and vehicle for coolant leakage.</li> <li>• Correct if necessary.</li> <li>• Change coolant every 24,000 km or 24 months (whichever comes first).</li> </ul>		√	√

\* Since these items require special tools, data and technical skills, they should be serviced by a Yamaha dealer.

EAU02970

## NOTE:

- The air filter needs more frequent service if you are riding in unusually wet or dusty areas.
- Hydraulic brake system
  - When disassembling the master cylinder or caliper, always replace the brake fluid. Check the brake fluid level regularly and fill as required.
  - Replace the oil seals on the inner parts of the master cylinder and caliper every two years.
  - Replace the brake hoses every four years or if cracked or damaged.

# PERIODIC MAINTENANCE AND MINOR REPAIR

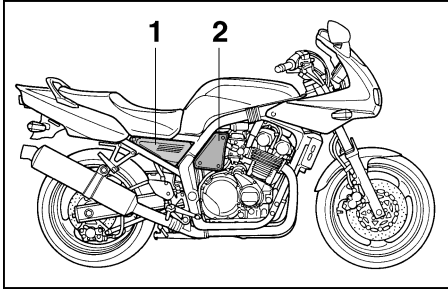

1. Panel A
2. Panel B

EAU01122

## Panel removal and installation

The panels illustrated need to be removed to perform some of the maintenance described in this chapter. Refer to this section each time a panel has to be removed or reinstalled.

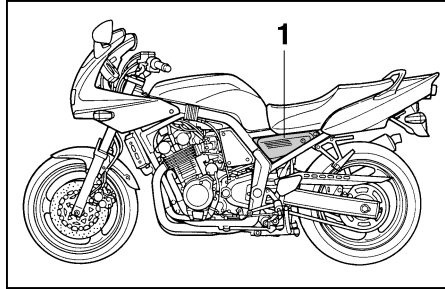

1. Panel C

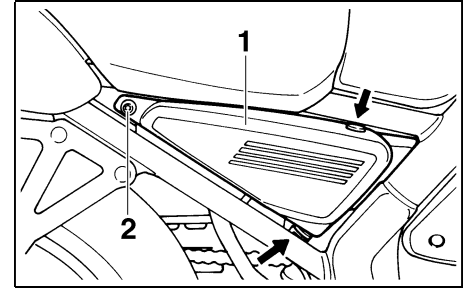

1. Panel A
2. Bolt

EAU00491

## Panel A, C

### To remove

Remove the bolt and pull outward on the areas shown.

### To install

Place the panel in its original position and install the bolt.

# PERIODIC MAINTENANCE AND MINOR REPAIR

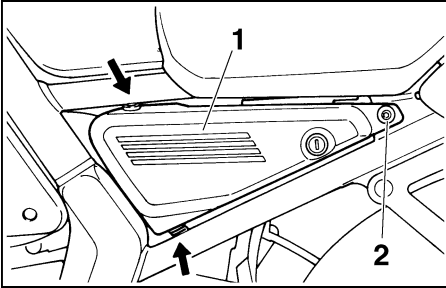

1. Panel C
2. Bolt

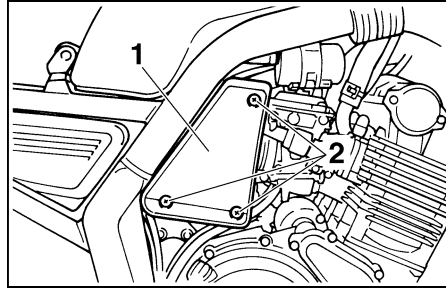

1. Panel B
2. Screw (× 3)

EAU01315

## Panel B

### To remove

Remove the screws.

### To install

Place the panel in the original position and install the screws.

# PERIODIC MAINTENANCE AND MINOR REPAIR

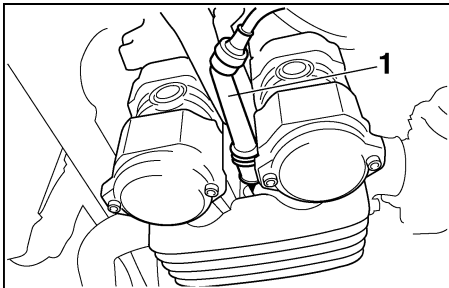

1. Spark plug cap

EAU01485\*

## Spark plugs

### Removal

1. Remove the spark plug caps.
2. Use the spark plug wrench in the tool kit to remove the spark plugs as shown.

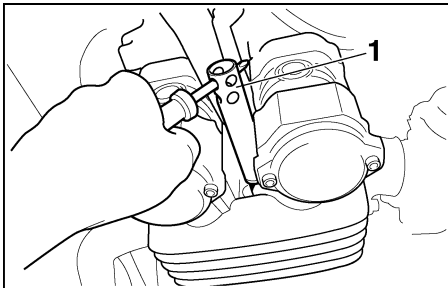

1. Spark plug wrench

### Inspection

The spark plug is an important engine component and is easy to inspect. The condition of the spark plug can indicate the condition of the engine. Normally, all spark plugs from the same engine should have the same color on the white insulator around the center electrode. The ideal color at this point is a medium-to-light tan color for a motorcycle that is being ridden normally. If one spark plug shows a distinctly different color, there could be something wrong with the engine. Do not attempt to diagnose such problems yourself. Instead, take the motorcycle to a Yamaha dealer. You should periodical-

ly remove and inspect the spark plugs because heat and deposits will cause any spark plug to slowly break down and erode. If electrode erosion becomes excessive, or if carbon and other deposits are excessive, you should replace the spark plug with the specified plug.

### Specified spark plug:

Except for D, F

CR8E, CR9E (NGK) or  
U24ESR-N, U27ESR-N  
(DENSO)

For D, F

CR7E, CR8E, CR9E (NGK) or  
U22ESR-N, U24ESR-N,  
U27ESR-N (DENSO)

# PERIODIC MAINTENANCE AND MINOR REPAIR

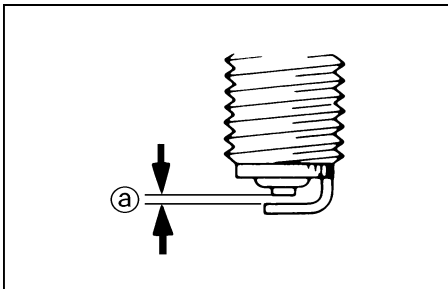

a. Spark plug gap

## Installation

1. Measure the electrode gap with a wire thickness gauge and, if necessary, adjust the gap to specification.

Spark plug gap:  
0.7 ~ 0.8 mm

2. Clean the gasket surface. Wipe off any grime from the threads.

3. Install the spark plug and tighten it to the specified torque.

Tightening torque:  
Spark plug:  
12.5 Nm (1.25 m·kg)

**NOTE:** \_\_\_\_\_  
If a torque wrench is not available when you are installing a spark plug, a good estimate of the correct torque is 1/4 to 1/2 turn past finger tight. Have the spark plug tightened to the specified torque as soon as possible.  
\_\_\_\_\_

# PERIODIC MAINTENANCE AND MINOR REPAIR

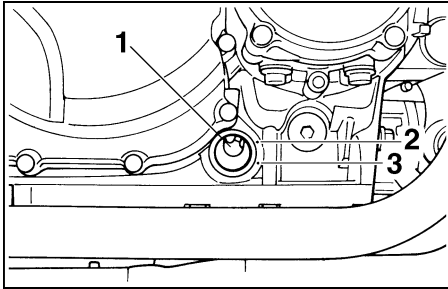

1. Oil level check window
2. Maximum level mark
3. Minimum level mark

EAU01717

## Engine oil

### Oil level inspection

1. Place the motorcycle on the centerstand. Warm up the engine for several minutes.

**NOTE:** \_\_\_\_\_

Be sure the motorcycle is positioned straight up when checking the oil level. A slight tilt toward the side can result in false readings.

---

2. With the engine stopped, check the oil level through the level window located at the lower part of the right side crankcase cover.

**NOTE:** \_\_\_\_\_  
Wait a few minutes until the oil level settles before checking.

---

3. The oil level should be between the maximum and minimum marks. If the level is low, fill the engine with sufficient oil to reach the specified level.

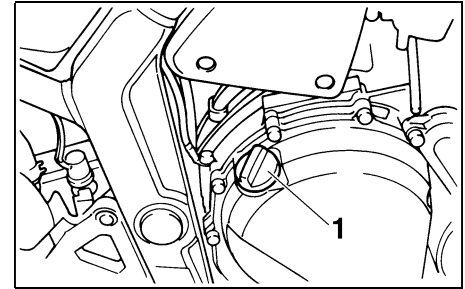

1. Engine oil filler cap

### Engine oil and oil filter cartridge replacement

1. Warm up the engine for several minutes.
2. Stop the engine. Place an oil pan under the engine and remove the oil filler cap.

# PERIODIC MAINTENANCE AND MINOR REPAIR

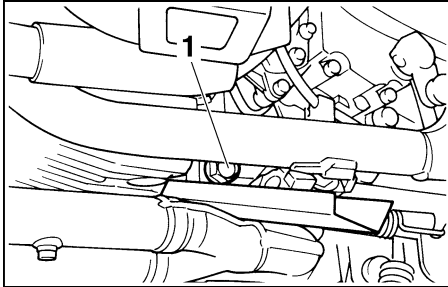

1. Engine oil drain bolt
3. Remove the drain bolt and drain the oil.

**NOTE:** \_\_\_\_\_  
When draining the engine oil, use a funnel or similar device to keep oil away from the exhaust pipe.

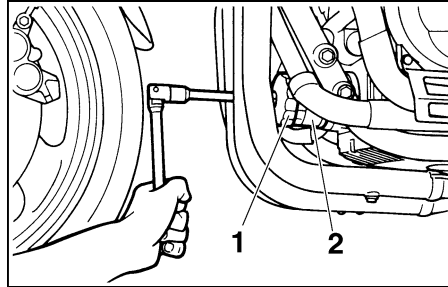

1. Oil filter wrench
2. Oil filter cartridge
4. Remove the oil filter by using an oil filter wrench.

**NOTE:** \_\_\_\_\_  
An oil filter wrench is available at a nearby Yamaha dealer.

5. Reinstall the drain bolt and tighten it to the specified torque.

Tightening torque:  
Drain bolt:  
43 Nm (4.3 m·kg)

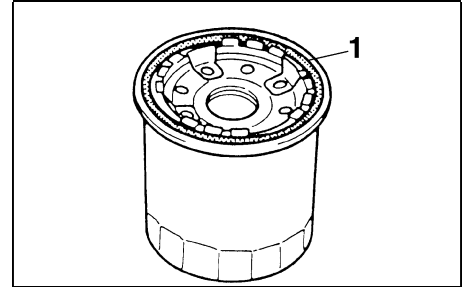

1. O-ring
6. Apply a light coat of engine oil to the O-ring of the new oil filter.

**NOTE:** \_\_\_\_\_  
Make sure the O-ring is seated properly.



# PERIODIC MAINTENANCE AND MINOR REPAIR

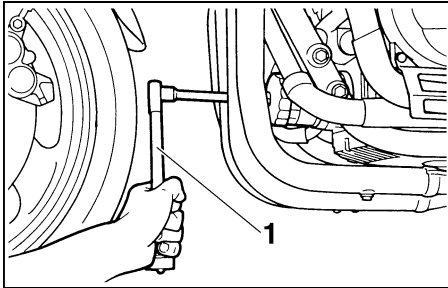

1. Torque wrench

7. Install the new oil filter and tighten it to the specified torque with an oil filter wrench.

**NOTE:** \_\_\_\_\_  
When installing the oil filter, tighten it to the proper torque by using a torque wrench.

Tightening torque:

Oil filter:

17 Nm (1.7 m·kg)

8. Fill the engine with sufficient oil to reach the specified level. Install the oil filler cap and tighten it.

Recommended oil:

See page 8-1.

Oil quantity:

Total amount:

3.5 L

Periodic oil change:

2.5 L

With oil filter replacement:

2.7 L

EC000066

**CAUTION:** \_\_\_\_\_

- Do not put in any chemical additives. Engine oil also lubricates the clutch and additives could cause clutch slippage.
- Be sure no foreign material enters the crankcase.

9. Start the engine and warm it up for several minutes. While warming up, check for oil leakage. If oil leakage is found, stop the engine immediately and check for the cause.

**NOTE:** \_\_\_\_\_

After the engine is started, the oil level indicator light should go off if the oil is at the specified level.

EC000067

**CAUTION:** \_\_\_\_\_

If the indicator light flickers or remains on, immediately stop the engine and consult with a Yamaha dealer.

# PERIODIC MAINTENANCE AND MINOR REPAIR

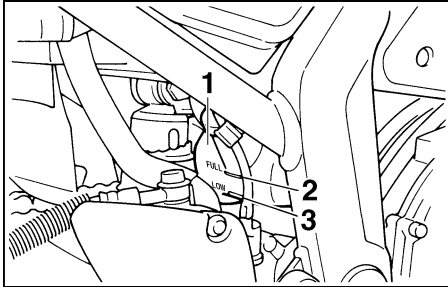

1. Reservoir tank
2. Maximum level mark
3. Minimum level mark

EAU01718

## Cooling system

1. Remove panel A. (See page 6-5 for panel removal and installation procedures.)
2. Check the coolant level in the reservoir tank when the engine is cold as the coolant level will vary with engine temperature. The coolant level should be between the maximum and minimum marks.
3. If the level is low, add coolant or distilled water to raise it to the specified level.
4. Install the panel.

Reservoir tank capacity:  
0.61 L

EC000080

### CAUTION:

**Hard water or salt water is harmful to the engine. You may use distilled water if you can't get soft water.**

### NOTE:

- If water is added, have a Yamaha dealer check the antifreeze content of the coolant as soon as possible.
- The radiator fan operation is completely automatic. It is switched on or off according to the coolant temperature in the radiator.

If your motorcycle overheats, see page 6-41 for details.

# PERIODIC MAINTENANCE AND MINOR REPAIR

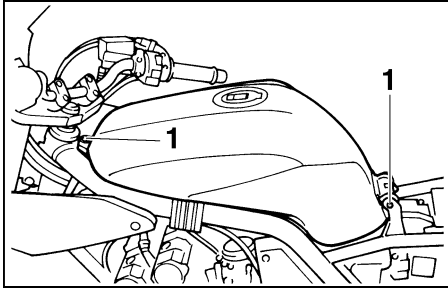

1. Bolt (× 2)

EAU01719\*

## Changing the coolant

1. Place the motorcycle on the centerstand.
2. Remove the seat.
3. Remove the fuel tank bolts.

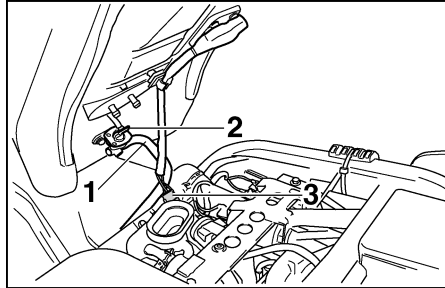

1. Hose
2. Fuel cock
3. Fuel level sensor connector
4. Lift the fuel tank upward and turn the fuel cock to "OFF".
5. Disconnect the fuel level sensor connector.
6. Pull the hose off the fuel cock, then remove the tank.

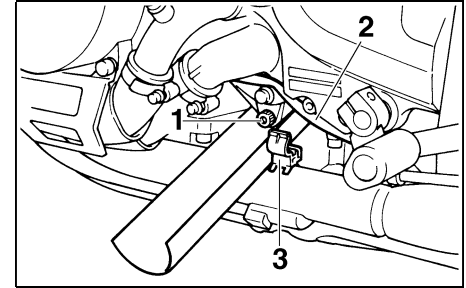

1. Coolant drain bolt
2. Sidestand switch lead
3. Plastic holder
7. Remove the sidestand switch lead from its holder.
8. Place a container under the engine and remove the coolant drain bolt to drain the coolant from the water pump.
9. Hold the container close to the drain hole and remove the radiator cap to drain the remaining coolant.

**NOTE:** \_\_\_\_\_  
When draining the coolant, use a funnel or similar object to keep coolant away from the frame.

# PERIODIC MAINTENANCE AND MINOR REPAIR

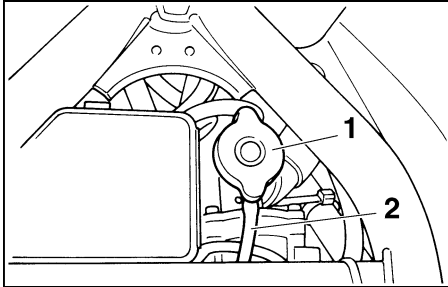

1. Radiator cap
2. Overflow hose

EW000067

## **⚠ WARNING**

**Do not remove the radiator cap when the engine is hot.**

10. Remove the coolant reservoir tank cap.
11. Remove the radiator overflow hose from the top of the radiator.

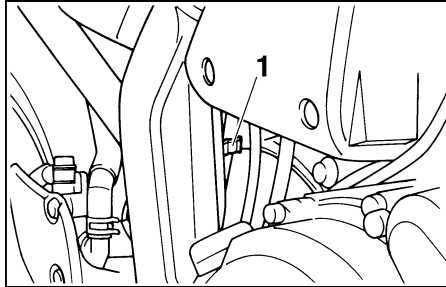

1. Plastic holder
12. Remove the hose holder from the frame.

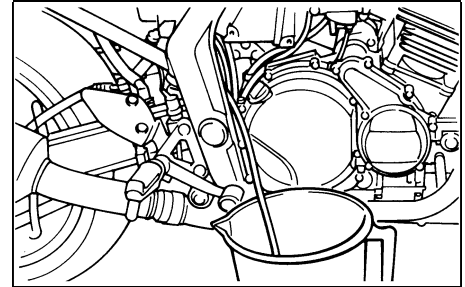

13. Pull the hose all the way down and to the outside while making sure to keep the end up. Then, tilt the hose downward into the container to drain the coolant from the reservoir tank.

**NOTE:** Take careful note of the radiator overflow hose's original routing to ensure proper installation.

14. After draining the coolant, thoroughly flush the cooling system with clean tap water.

# PERIODIC MAINTENANCE AND MINOR REPAIR

15. Replace the coolant drain bolt washer if it is damaged and tighten the coolant drain bolt to the specified torque.

Tightening torque:  
Coolant drain bolt:  
10 Nm (1.0 m·kg)

16. Install the radiator overflow hose. Make sure it is properly routed.
17. Pour the recommended coolant into the radiator until it is full.

Recommended antifreeze:  
High quality ethylene glycol antifreeze containing corrosion inhibitors for aluminum engines.  
Antifreeze and water mixing ratio:  
1:1  
Total amount:  
1.95 L  
Reservoir tank capacity:  
0.61 L

EC000080

## CAUTION:

**Hard water or salt water is harmful to the engine. You may use distilled water if you can't get soft water.**

18. Install the hose to the fuel cock, turn the fuel cock to "ON" and temporarily place back the fuel tank.
19. Run the engine several minutes. Stop the engine, lift the fuel tank slightly upward and recheck the coolant level in the radiator. If it is low, add more coolant until it reaches the top of the radiator.
20. Fill the reservoir tank with coolant up to the maximum level.
21. Install the radiator cap and reservoir tank cap. Check for coolant leakage.

## NOTE:

If any leakage is found, ask a Yamaha dealer to inspect the cooling system.

22. Install the fuel tank bolts.

EAU03016

## Air filter

The air filter element should be cleaned at the specified intervals. It should be cleaned more frequently if you are riding in unusually wet or dusty areas.

1. Remove the seat. (See page 3-14 for seat removal and installation procedures.)
2. Remove the fuel tank. (Refer to "Changing the coolant" for details on how to remove the fuel tank.)

EW000071

## WARNING

- Support the fuel tank carefully during this procedure.
  - Do not tilt the fuel tank too much or pull it too hard because the fuel hose connections may become loose causing fuel leakage.
3. Remove panels A, B and C. (See pages 6-5 and 6-6 for panel removal and installation procedures.)

# PERIODIC MAINTENANCE AND MINOR REPAIR

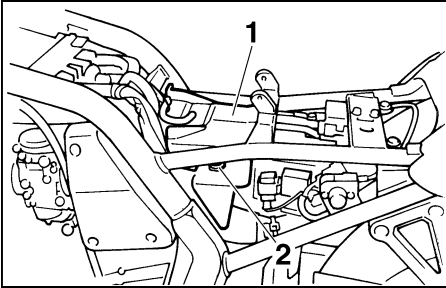

1. Rubber cover
2. Holder

4. Remove the rubber cover from its holders by pushing it downward. Then pull it upward and back as shown, away from the air filter case.

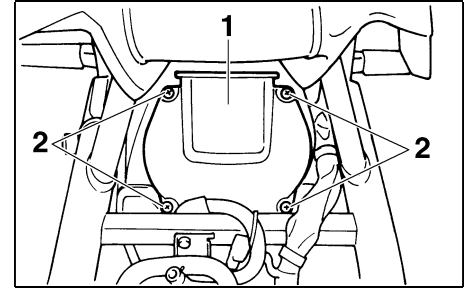
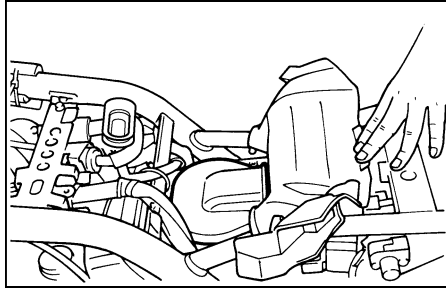

1. Air filter case cover
  2. Screw (× 4)
5. Remove the screws holding the air filter case cover.

# PERIODIC MAINTENANCE AND MINOR REPAIR

EW000072

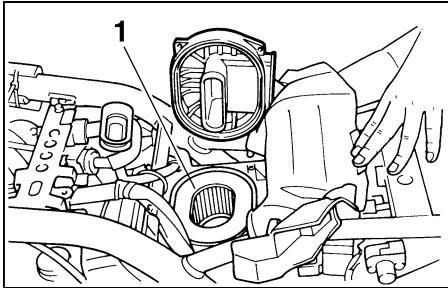

1. Air filter element

6. Pull out the air filter element.

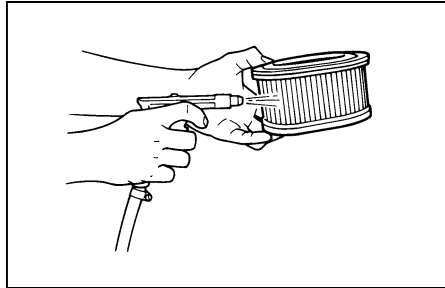

7. Tap the air filter element lightly to remove most of the dust and dirt. Blow out the remaining dirt with compressed air from the mesh side of the air filter element. If it is damaged, replace it.

8. Install by reversing the removal procedure.

EC000085

## CAUTION:

- Make sure the air filter is properly seated in the filter case.
- The engine should never be run without the air filter installed. Excessive piston and/or cylinder wear may result.

## WARNING

- Before reinstallation, make sure that the fuel hoses are not damaged at all. If any damage is found, it may result in a fuel leak, so do not start the engine. Ask a Yamaha dealer for repairs.
- Always make sure that the fuel hoses are properly connected, in place, and not pinched.

# PERIODIC MAINTENANCE AND MINOR REPAIR

## Carburetor adjustment

EAU00630

The carburetors are important parts of the engine and require very sophisticated adjustment. Most adjustments should be left to a Yamaha dealer who has the professional knowledge and experience to do so. However, the idle speed may be adjusted by the owner as part of routine maintenance.

EC000095

### CAUTION:

**The carburetors were set at the Yamaha factory after many tests. If they are changed, poor engine performance and damage may result.**

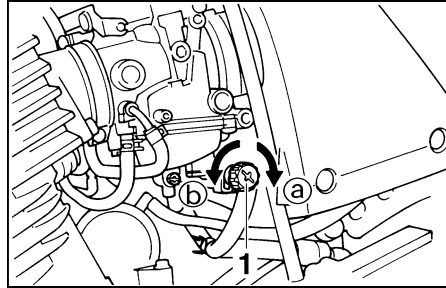

1. Throttle stop screw

EAU00632

## Idle speed adjustment

1. Start the engine and warm it up for a few minutes at approximately 1,000 to 2,000 r/min. Occasionally rev the engine to 4,000 to 5,000 r/min. The engine is warm when it quickly responds to the throttle.
2. Set the idle to the specified engine speed by adjusting the throttle stop screw. Turn the screw in direction (a) to increase engine speed and in direction (b) to decrease engine speed.

Standard idle speed:  
1,150 ~ 1,250 r/min

### NOTE:

If the specified idle speed cannot be obtained by performing the above adjustment, consult a Yamaha dealer.



# PERIODIC MAINTENANCE AND MINOR REPAIR

EAU00637

EAU00658

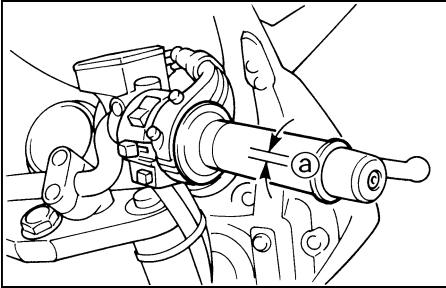

a. Free play

EAU00635

## Throttle cable free play inspection

There should be a free play of 3 ~ 5 mm at the throttle grip. If the free play is incorrect, ask a Yamaha dealer to make this adjustment.

6

## Valve clearance adjustment

The correct valve clearance changes with use, resulting in improper fuel/air supply or engine noise. To prevent this, the valve clearance must be adjusted regularly. This adjustment however, should be left to a professional Yamaha service technician.

## Tires

To ensure maximum performance, long service and safe operation, note the following:

### Tire air pressure

Always check and adjust the tire pressure before operating the motorcycle.

EW000082

### **WARNING**

Tire inflation pressure should be checked and adjusted when the temperature of the tire equals the ambient air temperature. Tire inflation pressure must be adjusted according to total weight of cargo, rider, passenger, and accessories (fairing, saddlebags, etc. if approved for this model), and vehicle speed.

# PERIODIC MAINTENANCE AND MINOR REPAIR

Maximum load*	187 kg	
Cold tire pressure	Front	Rear
Up to 90 kg load*	225 kPa (2.25 kg/cm <sup>2</sup> , 2.25 bar)	250 kPa (2.50 kg/cm <sup>2</sup> , 2.50 bar)
90 kg Maximum load*	225 kPa (2.25 kg/cm <sup>2</sup> , 2.25 bar)	290 kPa (2.90 kg/cm <sup>2</sup> , 2.90 bar)
High speed riding	225 kPa (2.25 kg/cm <sup>2</sup> , 2.25 bar)	290 kPa (2.90 kg/cm <sup>2</sup> , 2.90 bar)

\* Load is the total weight of cargo, rider, passenger and accessories.

EW000083

## **⚠ WARNING**

**Proper loading of your motorcycle is important for several characteristics of your motorcycle, such as handling, braking, performance and safety. Do not carry loosely packed items that can shift. Securely pack your heaviest items close to the center of the motorcycle, and distribute the weight evenly from side to side. Properly adjust the suspension for your load, and check the condition and pressure of your tires. NEVER OVERLOAD YOUR MOTORCYCLE. Make sure the total weight of the cargo, rider, passenger, and accessories (fairing, saddlebags, etc. if approved for this model) does not exceed the maximum load of the motorcycle. Operation of an overloaded motorcycle could cause tire damage, an accident, or even injury.**

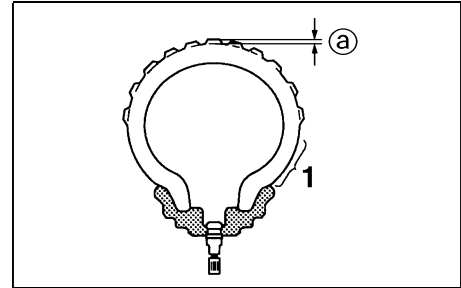

- 1. Side wall
- a. Tread depth

## **Tire inspection**

Always check the tires before operating the motorcycle. If center tread depth reaches the limit as shown, if the tire has a nail or glass fragments in it, or if the side wall is cracked, contact a Yamaha dealer immediately and have the tire replaced.

# PERIODIC MAINTENANCE AND MINOR REPAIR

EW000095

## ⚠ WARNING

Operating the motorcycle with excessively worn tires decrease riding stability and can lead to loss of control. Have excessively worn tires replaced by a Yamaha dealer immediately. Brakes, tires, and related wheel parts replacement should be left to a Yamaha Service Technician.

Minimum tire tread depth (front and rear)	1.6 mm
--	--------

## NOTE:

These limits may be different by regulation from country to country. If so, conform to the limits specified by the regulations of your own country.

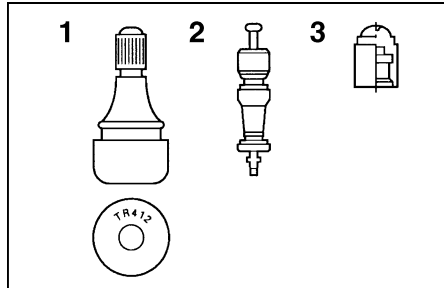

1. Tire valve
2. Valve core
3. Valve cap with seal

## Tire information

This motorcycle is equipped with tubeless tires, tire valves and cast wheels.

EW000080

## ⚠ WARNING

- After extensive tests, the tires mentioned below have been approved by Yamaha Motor Co., Ltd. for this model. No guarantee for handling characteristics can be given if tire combinations other than what is approved are used on this motorcycle. The front and rear tires should be of the same manufacture and design.
- The use of tire valves and valve cores other than listed below could cause tire deflation during extreme high speed riding. Always use genuine parts or their equivalent for replacement.
- Be sure to install the valve caps securely, as these are important to prevent air pressure leakage during extreme high speed riding.

# PERIODIC MAINTENANCE AND MINOR REPAIR

EAU00684

EAU00687

## FRONT

Manufacturer	Size	Type
Bridgestone	110/70 ZR17 (54W)	BT-57F
Dunlop	110/70 ZR17 (54W)	D207F
Metzeler	110/70 ZR17 (54W)	MEZ1 FRONT
Michelin	110/70 ZR17 (54W)	MACADAM 90X

## REAR

Manufacturer	Size	Type
Bridgestone	160/60 ZR17 (69W)	BT-57R
Dunlop	160/60 ZR17 (69W)	D207J
Metzeler	160/60 ZR17 (69W)	MEZ1
Michelin	160/60 ZR17 (69W)	MACADAM 90X

	Type
Tire valve	TR412
Valve core	#9000A (original)

## WARNING

**This motorcycle is fitted with super high-speed running tires. The following points must be observed in order for you to make fully effective use of these tires.**

- **Never fail to use the specified tires in tire replacement. Other tires may have a danger of bursting at super high-speeds.**
- **New tires have a relatively low grip on the road surface until they have been slightly worn. Therefore, approximately 100 km should be traveled at normal speed before any high-speed riding is done.**
- **Before any high-speed runs, the tires should be warmed-up sufficiently.**
- **Always inflate to the correct tire pressure according to the operating conditions.**

## Wheels

To ensure maximum performance, long service, and safe operation, note the following:

- Always inspect the wheels before a ride. Check for cracks, bends, or warpage of the wheels. If any abnormal condition exists in a wheel, consult a Yamaha dealer. Do not attempt even small repairs to the wheel. If a wheel is deformed or cracked, it must be replaced.
- Tires and wheels should be balanced whenever either one is changed or replaced. Failure to have a wheel balanced can result in poor performance, adverse handling characteristics, and shortened tire life.
- Ride at moderate speeds after changing a tire since the tire surface must first be broken in for it to develop its optimal characteristics.

# PERIODIC MAINTENANCE AND MINOR REPAIR

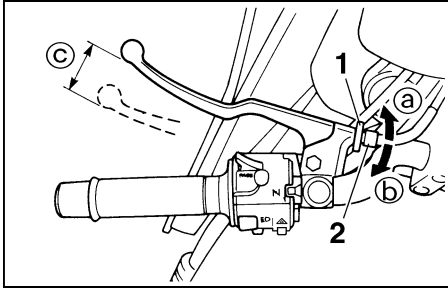

- 1. Locknut
- 2. Adjusting bolt
- c. Free play

EAU00692

## Clutch lever free play adjustment

The clutch lever free play should be adjusted to 10 ~ 15 mm. If the free play is incorrect, adjust as follows.

1. Loosen the locknut.
2. Turn the adjusting bolt at the clutch lever in direction (a) to increase free play or in direction (b) to decrease free play.
3. Tighten the locknut.

**NOTE:** \_\_\_\_\_  
If proper adjustment cannot be obtained or the clutch does not work correctly, ask a Yamaha dealer to inspect the internal clutch mechanism.  
\_\_\_\_\_

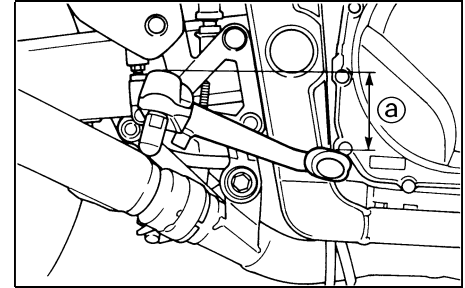

- a. Pedal height

EAU00712\*

## Rear brake pedal height check

The top of the brake pedal should be positioned 36.6 mm below the top of the footrest. If not, ask a Yamaha dealer to adjust it.

EW000109

## **! WARNING**

A soft or spongy feeling in the brake pedal can indicate the presence of air in the brake system. This air must be removed by bleeding the brake system before the motorcycle is operated. Air in the system will cause greatly diminished braking capability and can result in loss of control and an accident. Have a Yamaha dealer inspect and bleed the system if necessary.

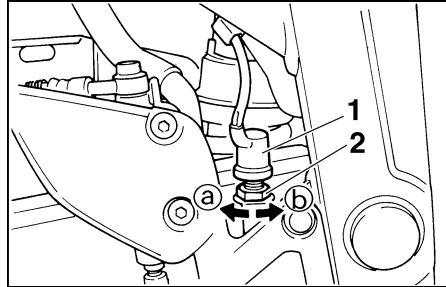

1. Brake light switch
2. Adjusting nut

EAU00713

## **Brake light switch adjustment**

The rear brake light switch is activated by the brake pedal and is properly adjusted when the brake light comes on just before braking takes effect. To adjust the rear brake light switch, hold the switch body so it does not rotate while turning the adjusting nut. Turn the adjusting nut in direction Ⓐ to make the brake light come on earlier. Turn the adjusting nut in direction Ⓑ to make the brake light come on later.

# PERIODIC MAINTENANCE AND MINOR REPAIR

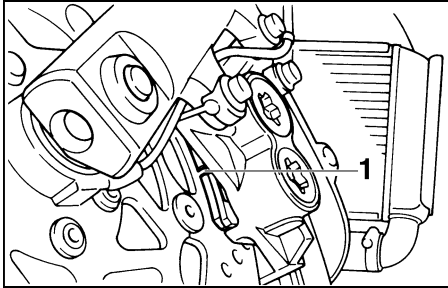

1. Wear indicator groove

EAU01314

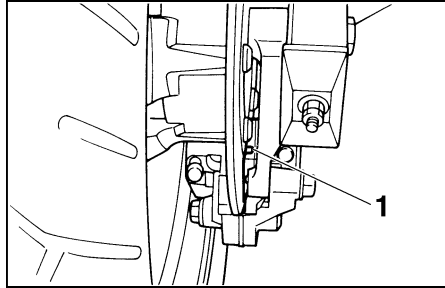

1. Wear indicator groove

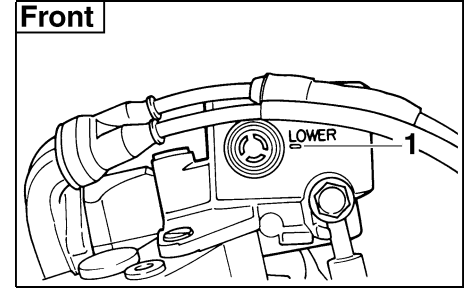

1. Minimum level mark

EAU00731

## Checking the front and rear brake pads

Each brake pad is provided with a wear indicator groove, which allows checking the brake pad for wear without disassembling the brake. Inspect each wear indicator groove and, as soon as one of them has almost worn away, ask a Yamaha dealer to replace the brake pads as a set.

## Inspecting the brake fluid level

Insufficient brake fluid may let air enter the brake system, possibly causing the brakes to become ineffective.

Before riding, check that the brake fluid is above the minimum level and replenish when necessary.

Observe these precautions:

- When checking the fluid level, make sure the top of the master cylinder is level by turning the handlebars.

# PERIODIC MAINTENANCE AND MINOR REPAIR

EAU00742

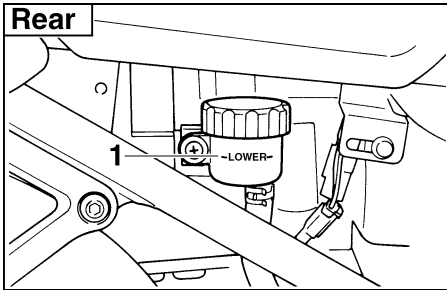

1. Minimum level mark

- Use only the designated quality brake fluid. Otherwise, the rubber seals may deteriorate, causing leakage and poor brake performance.

Recommended brake fluid: DOT 4

- Refill with the same type of brake fluid. Mixing fluids may result in a harmful chemical reaction and lead to poor brake performance.

- Be careful that water does not enter the master cylinder when refilling. Water will significantly lower the boiling point of the fluid and may result in vapor lock.
- Brake fluid may deteriorate painted surfaces or plastic parts. Always clean up spilled fluid immediately.
- Have a Yamaha dealer check the cause if the brake fluid level goes down.

## Brake fluid replacement

The brake fluid should be replaced only by trained Yamaha service personnel. Have the Yamaha dealer replace the following components during periodic maintenance or when they are damaged or leaking:

- oil seals (every two years)
- brake hoses (every four years)



# PERIODIC MAINTENANCE AND MINOR REPAIR

EC000096

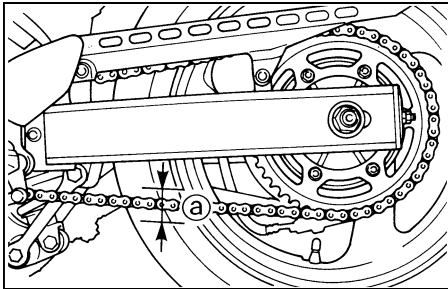

a. Chain slack

EAU00745

## Drive chain slack check

### NOTE:

Spin the wheel several times and find the tightest position of the chain. Check and/or adjust the chain slack while it's in this tightest position.

Inspect the drive chain when the motorcycle is on the centerstand. Check the slack at the position shown in the illustration. Normal slack is approximately 30 ~ 45 mm. If the slack exceeds 45 mm, adjust.

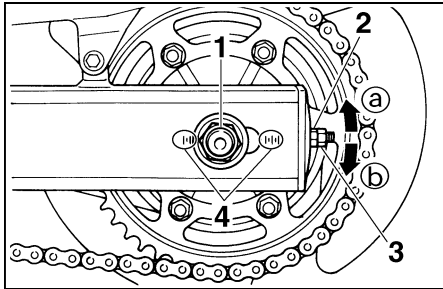

1. Axle nut
2. Chain adjusting nut
3. Locknut
4. Alignment marks

EAU00762

## Drive chain slack adjustment

1. Loosen the axle nut.
2. Loosen the locknuts on each side.

To tighten the chain, turn the chain adjusting nuts in direction ①. To loosen the chain, turn the adjusting nuts in direction ② and push the wheel forward. Turn each adjusting nut exactly the same amount to maintain correct axle alignment. There are marks on each side of the swingarm. Use these marks to align the rear wheel.

### CAUTION:

Too little chain slack will overload the engine and other vital parts. Keep the slack within the specified limits.

3. After adjusting, tighten the locknuts. Then tighten the axle nut to the specified torque.

Tightening torque:

Axle nut:

117 Nm (11,7 m·kg)

## Drive chain lubrication

EAU03006

The chain consists of many parts which work with each other. If the chain is not maintained properly, it will wear out quickly. Therefore, the chain must be serviced regularly. This service is especially necessary when riding in dusty areas. This motorcycle is equipped with a sealed type chain. Steam cleaning, high-pressure washers, and solvents can damage the drive chain, so do not use these for cleaning it. Use only kerosene to clean the drive chain. Wipe it dry, and thoroughly lubricate it with SAE 30 ~ 50W motor oil. Do not use any other lubricants on the drive chain. They may contain solvents that could damage the sealed chain.

EC000097

### **CAUTION:**

**Be sure to oil the chain after washing the motorcycle or riding in the rain.**

## Cable inspection and lubrication

EAU02962

EW000112



**Damage to the outer housing of cables may lead to internal rusting and interfere with the cable movement. Replace damaged cables as soon as possible to prevent unsafe conditions.**

Lubricate the cables and cable ends. If a cable does not operate smoothly, ask a Yamaha dealer to replace it.

Recommended lubricant:  
Engine oil

## Throttle cable and grip lubrication

EAU00773

The throttle twist grip assembly should be greased at the time that the cable is lubricated, since the grip must be removed to get at the end of the throttle cable. After removing the screws, hold the end of the cable up in the air and put in several drops of lubricant. With the throttle grip disassembled, coat the metal surface of the grip assembly with a suitable all-purpose grease.

# PERIODIC MAINTENANCE AND MINOR REPAIR

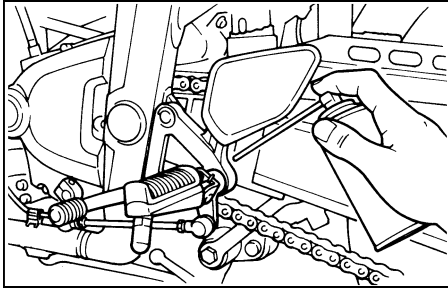

EAU02984

## Brake and shift pedal lubrication

Lubricate the pivoting parts.

Recommended lubricant:  
Engine oil

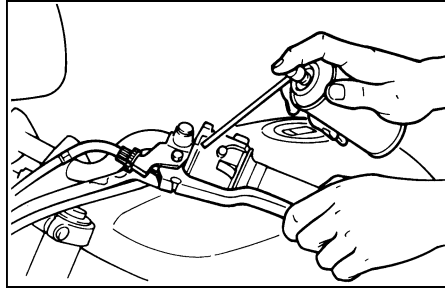

EAU02985

## Brake and clutch lever lubrication

Lubricate the pivoting parts.

Recommended lubricant:  
Engine oil

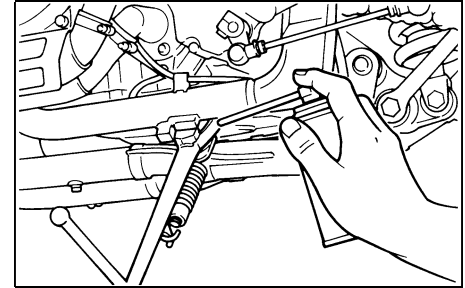

EAU02965

## Center and sidestand lubrication

Lubricate the pivoting and mating joints.

Check to see that the center and sidestand move up and down smoothly.

Recommended lubricant:  
Engine oil

EW000114

### **! WARNING**

If the center and/or sidestand does not move smoothly, consult a Yamaha dealer.

# PERIODIC MAINTENANCE AND MINOR REPAIR

## Rear suspension lubrication

EAU00790

Lubricate the pivoting parts.

Recommended lubricant:  
Molybdenum disulfide grease

## Front fork inspection

EAU02939

Visual check

EW000115



**Securely support the motorcycle so there is no danger of it falling over.**

Check for scratches or damage on the inner tube and excessive oil leakage from the front fork.

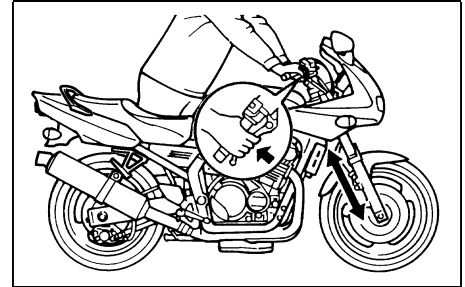

## Operation check

1. Place the motorcycle on a level place.
2. Hold the motorcycle in an upright position and apply the front brake.
3. Push down hard on the handlebars several times and check if the fork rebounds smoothly.

EC000098

## CAUTION:

**If any damage or unsmooth movement is found with the front fork, consult a Yamaha dealer.**

# PERIODIC MAINTENANCE AND MINOR REPAIR

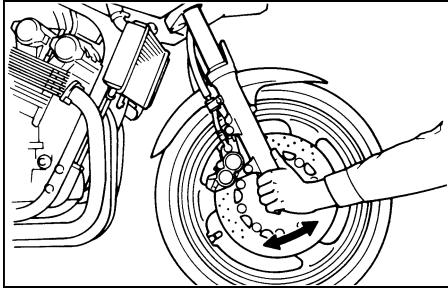

EAU00794

## Steering inspection

Periodically inspect the condition of the steering. Worn out or loose steering bearings may be dangerous. Place a stand under the engine to raise the front wheel off the ground. Hold the lower end of the front forks and try to move them forward and backward. If any free play can be felt, ask a Yamaha dealer to inspect and adjust the steering. Inspection is easier if the front wheel is removed.

EW000115

### **⚠ WARNING**

**Securely support the motorcycle so there is no danger of it falling over.**

EAU01144

## Wheel bearings

If there is play in the front or rear wheel hub or if the wheel does not turn smoothly, have a Yamaha dealer inspect the wheel bearings.

EAU01271

## Battery

This motorcycle is equipped with a sealed-type battery. Therefore it is not necessary to check the electrolyte or fill the battery with distilled water.

- If the battery seems to have discharged, consult a Yamaha dealer.
- If the motorcycle is equipped with optional electrical accessories, the battery tends to discharge more quickly, so be sure to recharge it periodically.

# PERIODIC MAINTENANCE AND MINOR REPAIR

EW000116

## **WARNING**

Battery electrolyte is poisonous and dangerous, causing severe burns, etc. It contains sulfuric acid. Avoid contact with skin, eyes or clothing.

### ANTIDOTE:

- **EXTERNAL:** Flush with water.
- **INTERNAL:** Drink large quantities of water or milk. Follow with milk of magnesia, beaten egg, or vegetable oil. Call a physician immediately.
- **EYES:** Flush with water for 15 minutes and get prompt medical attention.

Batteries produce explosive gases. Keep sparks, flame, cigarettes etc., away. Ventilate when charging or using in an enclosed space. Always shield your eyes when working near batteries. **KEEP OUT OF REACH OF CHILDREN.**

## **Battery storage**

When the motorcycle is not used for a month or longer, remove the battery, fully charge it and store it in a cool, dry place.

EC000102

## **CAUTION:**

- **Completely recharge the battery before storing.** Storing a discharged battery can cause permanent battery damage.
- **Use a battery charger designed for a sealed-type (MF) battery.** Using a conventional battery charger will cause battery damage. If you do not have a sealed-type battery charger, contact your Yamaha dealer.
- **Always make sure the connections are correct when reinstalling the battery.**

# PERIODIC MAINTENANCE AND MINOR REPAIR

EC000103

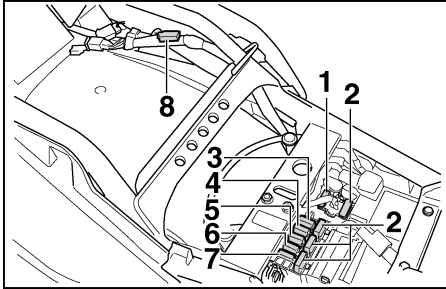

1. Main fuse
2. Spare fuse (× 4)
3. Ignition fuse
4. Signaling system fuse
5. Headlight fuse
6. Radiator fan fuse
7. Odometer fuse
8. Parking/Hazard lights fuse

EAU01720\*

## Fuse replacement

The fuse boxes are located under the seat. If any fuse is blown, turn off the main switch and the switch of the circuit in question. Install a new fuse of specified amperage. Turn on the switches and see if the electrical device operates. If a fuse immediately blows again, consult a Yamaha dealer.

### CAUTION:

Do not use fuses of higher amperage rating than those recommended. Substitution of a fuse of improper rating can cause extensive electrical system damage and possibly a fire.

#### Specified fuses:

Main fuse:	30 A
Headlight fuse:	20 A
Parking/Hazard lights fuse:	10 A
Ignition fuse:	20 A
Signaling system fuse:	20 A
Odometer fuse:	5 A
Radiator fan fuse:	10 A

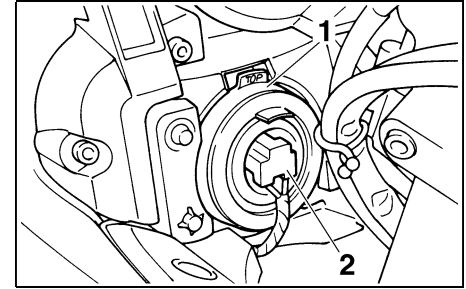

1. Bulb holder cover
2. Connector

EAU00826

## Headlight bulb replacement

This motorcycle is equipped with a quartz bulb headlight. If the headlight bulb burns out, replace the bulb as follows:

1. Remove the headlight connector and the bulb holder cover.

# PERIODIC MAINTENANCE AND MINOR REPAIR

EC000104

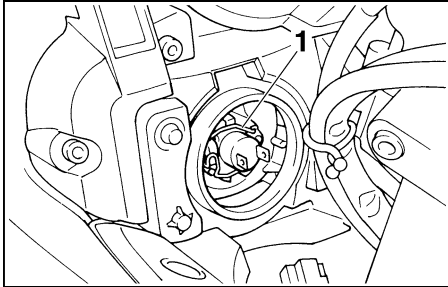

1. Bulb holder
2. Unhook the bulb holder and remove the defective bulb.

EW000119

## **WARNING**

Keep flammable products and your hands away from a bulb while it is on, as it is hot. Do not touch a bulb until it cools down.

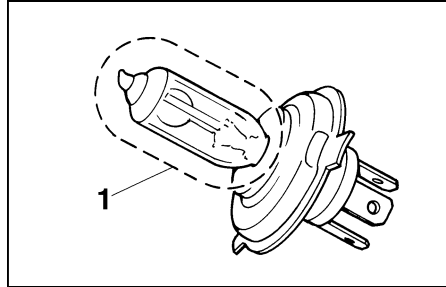

1. Don't touch
3. Put a new bulb into position and secure it in place with the bulb holder.

## **CAUTION:**

To prevent damage to the following:

- **Headlight bulb**  
Avoid touching the glass part of the bulb. Keep it free from oil; otherwise, the transparency of the glass, life of the bulb, and illuminous flux will be adversely affected. If oil gets on the bulb, thoroughly clean it with a cloth moistened with alcohol or lacquer thinner.
- **Headlight lens**
  - Do not affix any type of tinted film or stickers to the headlight lens.
  - Do not use headlight bulbs of wattage higher than specified.

4. Install the bulb holder cover and reconnect the headlight connector. If the headlight beam adjustment is necessary, ask a Yamaha dealer to make that adjustment.



# PERIODIC MAINTENANCE AND MINOR REPAIR

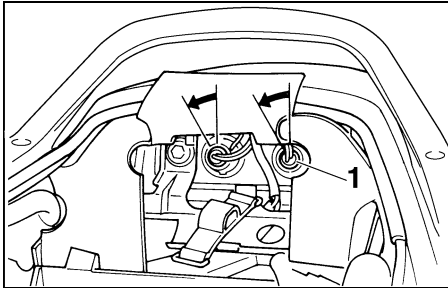

1. Socket

EAU00858

## Taillight bulb replacement

1. Remove the seat.
2. Remove the tool kit.
3. To remove the socket, turn it counterclockwise.
4. To remove the defective bulb, turn it counterclockwise.
5. Push a new bulb into the socket and turn it clockwise.
6. Install the socket and turn it clockwise.
7. Install the tool kit and seat.

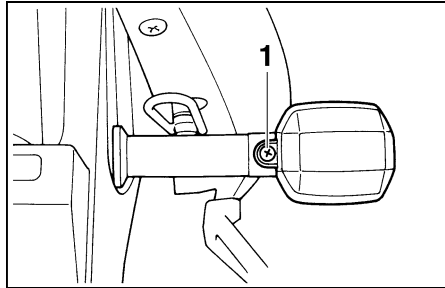

1. Screw

EAU01095

## Turn signal light bulb replacement

1. Remove the screw and the lens.
2. Remove the defective bulb by pushing it inward and turning it counterclockwise.
3. Install a new bulb by pushing it inward and turning it clockwise.
4. Install the lens and tighten the screw.

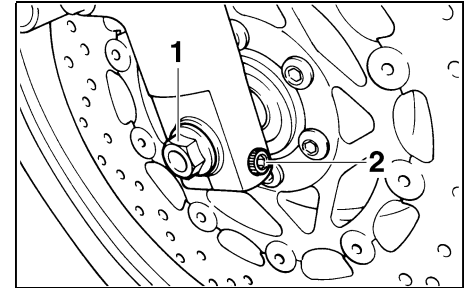

1. Axle

2. Pinch bolt

EAU01310

## Front wheel removal

EW000122

### **WARNING**

- It is advisable to have a Yamaha dealer service the wheel.
- Securely support the motorcycle so there is no danger of it falling over.

1. Place the motorcycle on the centerstand.
2. Loosen the pinch bolt, wheel axle and calipers bolts.
3. Elevate the front wheel.

# PERIODIC MAINTENANCE AND MINOR REPAIR

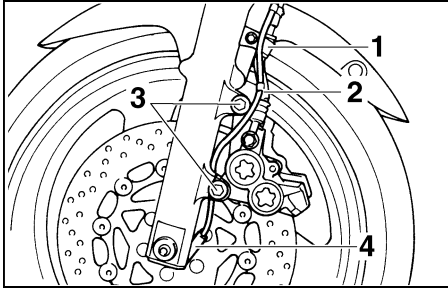

1. Brake hose holder
2. Plastic clamp
3. Caliper bolt (× 2)
4. Speed sensor
4. Remove the brake hose holders and calipers.
5. Remove the plastic clamp holding the speed sensor lead to the brake cable.

**NOTE:** \_\_\_\_\_  
Do not depress the brake lever when the calipers are off the discs as the brake pads will be forced shut.

6. While supporting the speed sensor, remove the axle. Make sure the motorcycle is properly supported.

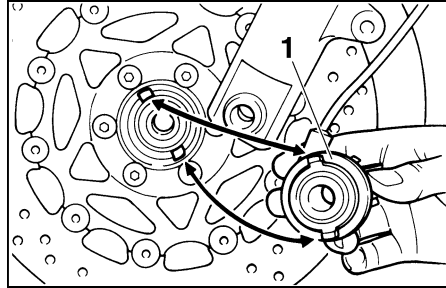

1. Speed sensor

## Front wheel installation

1. Lift up the wheel between the front fork legs.
2. Install the speed sensor onto the wheel hub. Make sure the speed sensor rotor projections are aligned with the notches in the wheel hub.

EAU01309

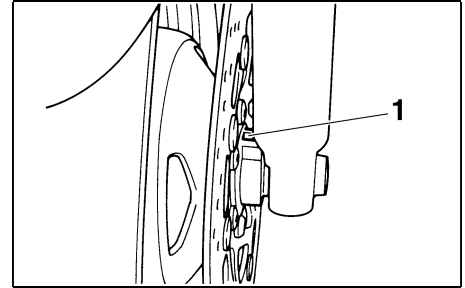

1. Stopper

3. Install the wheel axle (make sure the slot in the speed sensor fits over the stopper on the front fork outer tube) and let the motorcycle down.
4. Push down hard on the handlebars several times to check for proper fork operation.
5. Install the calipers, caliper bolts and brake hose holders. Make sure there is enough gap between the brake pads before installing the calipers onto the brake discs.
6. Attach the speed sensor cable to the brake hose with the plastic clamp.

# PERIODIC MAINTENANCE AND MINOR REPAIR

7. Tighten the wheel axle, pinch bolt and caliper bolts to the specified torques.

Tightening torque:

Wheel axle:

67 Nm (6.7 m·kg)

Pinch bolt:

20 Nm (2.0 m·kg)

Caliper bolt:

40 Nm (4.0 m·kg)

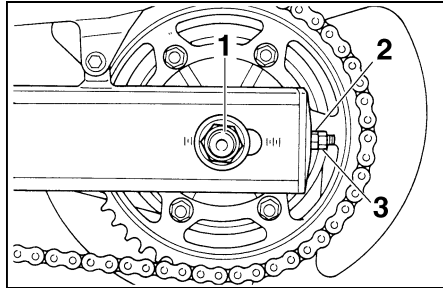

1. Axle nut
2. Chain adjusting nut
3. Locknut

EAU01318

## Rear wheel removal

EW000122

### WARNING

- It is advisable to have a Yamaha dealer service the wheel.
- Securely support the motorcycle so there is no danger of it falling over.

1. Loosen the axle nut and caliper bolts.
2. Remove the brake torque rod nut and bolt.

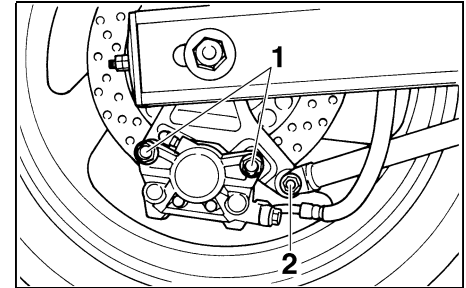

1. Caliper bolt (× 2)
2. Brake torque rod nut
3. Place the motorcycle on the centerstand.
4. Remove the axle nut, caliper bolts and caliper.
5. Loosen the locknuts and chain adjusting nuts on each side of the swingarm.
6. Push the wheel forward and remove the drive chain.
7. Support the caliper bracket, pull out the wheel axle and remove the wheel assembly by pulling it backwards.

# PERIODIC MAINTENANCE AND MINOR REPAIR

## NOTE:

- Do not depress the brake pedal when the caliper is off the disc as the brake pads will be forced shut.
- You do not have to disassemble the chain in order to remove or install the rear wheel.

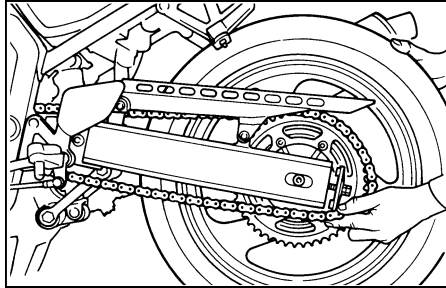

EAU01317

## Rear wheel installation

1. Install the caliper bracket and wheel assembly, then insert the axle.
2. Install and adjust the drive chain. (See page 6-27 for details about adjusting the drive chain slack.)
3. Install the brake torque rod bolt and nut.
4. Install the caliper and caliper bolts. Make sure there is enough gap between the brake pads before installing the caliper onto the brake disc.
5. Take the motorcycle off the centerstand.

6. Tighten the axle nut, caliper bolts and the brake torque rod nut to the specified torques.

### Tightening torque:

Axle nut:

117 Nm (11.7 m·kg)

Caliper bolt:

40 Nm (4.0 m·kg)

Brake torque rod nut:

23 Nm (2.3 m·kg)

# PERIODIC MAINTENANCE AND MINOR REPAIR

---

EAU01008

## Troubleshooting

Although Yamaha motorcycles receive a rigid inspection before shipment from the factory, trouble may occur during operation.

Any problem in the fuel, compression, or ignition systems can cause poor starting and loss of power. The troubleshooting chart describes a quick, easy procedure for making checks.

If your motorcycle requires any repair, bring it to a Yamaha dealer. The skilled technicians at a Yamaha dealership have the tools, experience, and know-how to properly service your motorcycle. Use only genuine Yamaha parts on your motorcycle. Imitation parts may look like Yamaha parts, but they are often inferior. Consequently, they have a shorter service life and can lead to expensive repair bills.

# PERIODIC MAINTENANCE AND MINOR REPAIR

## Troubleshooting chart

EAU02990\*

EW000125



**WARNING**

**Never check the fuel system while smoking or in the vicinity of an open flame.**

### 1. Fuel

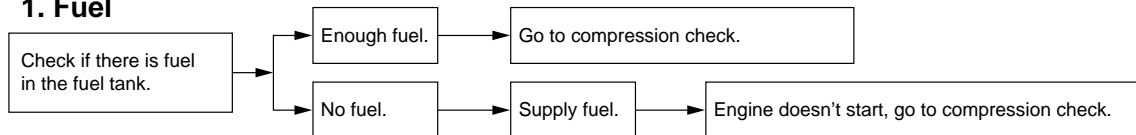

### 2. Compression

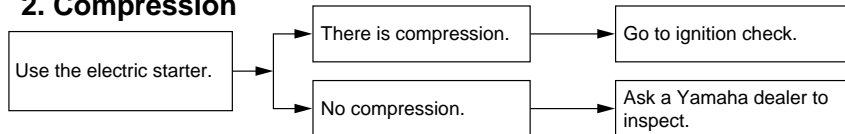

### 3. Ignition

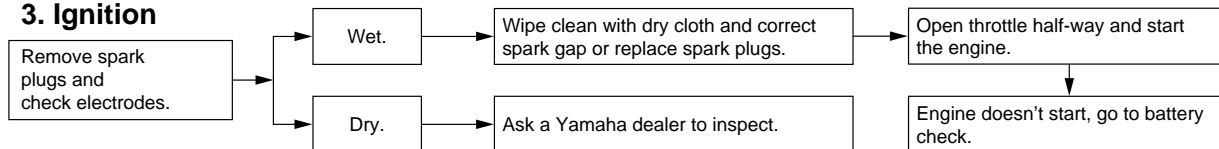

### 4. Battery

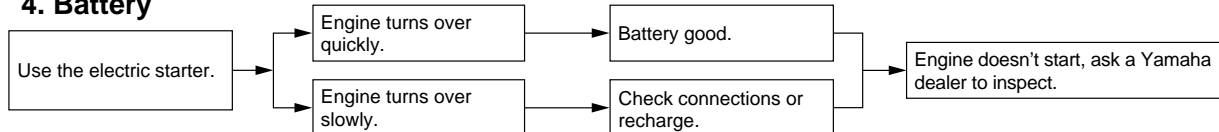

# PERIODIC MAINTENANCE AND MINOR REPAIR

## 5. Engine overheating

EW000070

### **⚠ WARNING**

Do not remove the radiator cap when the engine and radiator are hot. Scalding hot fluid and steam may be blown out under pressure, which could cause serious injury. Open the radiator cap as follows. Wait until the engine has cooled. Remove the radiator cap stopper by removing the screw. Place a thick rag like a towel over the radiator cap and slowly rotate the cap counterclockwise to the detent. This procedure allows any residual pressure to escape. When the hissing sound has stopped, press down on the cap while turning counterclockwise and remove it.

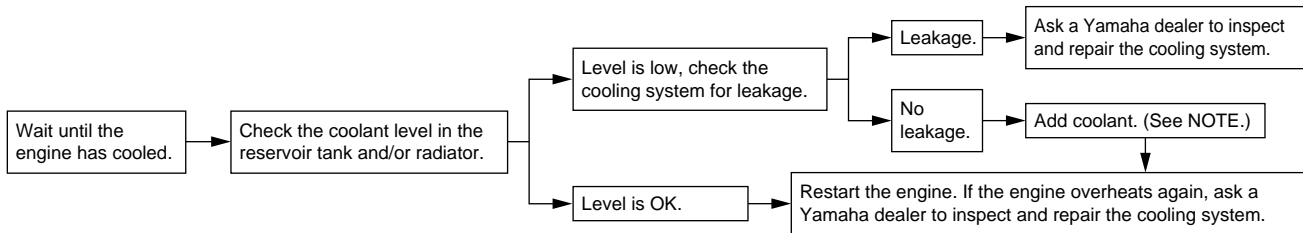

### **NOTE:**

If it is difficult to get the recommended coolant, tap water can be temporarily used, provided that it is changed to the recommended coolant as soon as possible.

# MOTORCYCLE CARE AND STORAGE

---

---

Care .....	7-1
Storage.....	7-4



## Care

The exposure of its technology makes a motorcycle charming but also vulnerable. Although high-quality components are used, they are not all rust-resistant. While a rusty exhaust pipe may remain unnoticed on a car, it does look unattractive on a motorcycle. Frequent and proper care, however, will keep your motorcycle looking good, extend its life and maintain its performance. Moreover, the warranty states that the vehicle must be properly taken care of. For all these reasons, it is recommended that you observe the following cleaning and storing precautions.

## Before cleaning

1. Cover up the muffler outlet with a plastic bag.
2. Make sure that all caps and covers as well as all electrical couplers and connectors, including the spark plug caps, are tightly installed.
3. Remove extremely stubborn dirt, like oil burnt onto the crankcase, with a degreasing agent and a brush, but never apply such products onto seals, gaskets, sprockets, the drive chain and wheel axles. Always rinse the dirt and degreaser off with water.

## Cleaning

### After normal use

Remove dirt with warm water, a neutral detergent and a soft clean sponge, then rinse with plenty of clean water. Use a tooth or bottle brush for hard-to-reach parts. Tougher dirt and insects will come off more easily if the area is covered with a wet cloth for a few minutes before cleaning.

# MOTORCYCLE CARE AND STORAGE

ECA00010

## CAUTION:

- Avoid using strong acidic wheel cleaners, especially on spoked wheels. If you do use such products for hard-to-remove dirt, do not leave it on any longer than instructed, then thoroughly rinse it off with water, immediately dry the area and apply a corrosion protection spray.
- Improper cleaning can damage windshields, cowlings, panels and other plastic parts. Use only a soft, clean cloth or sponge with mild detergent and water to clean plastic.
- Do not use any harsh chemical products on plastic parts. Be sure to avoid using cloths or sponges which have been in contact with strong or abrasive cleaning products, solvent or thinner, fuel (gasoline), rust removers or inhibitors, brake fluid, antifreeze or electrolyte.
- Do not use high-pressure washers or steam-jet cleaners since they cause water seepage and deterioration in the following areas: seals (of wheel bearings, swingarm bearings, forks and brakes), electric components (couplers, connectors, instruments, switches and lights), breather hoses and vents.
- For motorcycles equipped with a windshield: Do not use strong cleaners or hard sponges as they will cause dulling or scratching. Some cleaning compounds for plastic may leave scratches on the windshield. Test the product on a small hidden part of the windshield to make sure they do not leave any marks. If the windshield is scratched, use a quality plastic polishing compound after washing.

After riding in the rain, near the sea or on salt-sprayed roads

Since sea salt or salt sprayed on the roads in the winter are extremely corrosive in combination with water, carry out the following steps after each ride in the rain, near the sea or on salt-sprayed roads. (Salt sprayed in the winter may remain on the roads well into spring.)

# MOTORCYCLE CARE AND STORAGE

---

---

1. Clean your motorcycle with cold water and soap after the engine has cooled down.

ECA00012

## **CAUTION:**

**Do not use warm water since it increases the corrosive action of the salt.**

2. Be sure to apply a corrosion protection spray on all (even chrome- and nickel-plated) metal surfaces to prevent corrosion.

## **After cleaning**

1. Dry the motorcycle with a chamois or an absorbing cloth.
2. Immediately dry the drive chain and lubricate it to prevent it from rusting.
3. Use a chrome polish to shine chrome, aluminum and stainless-steel parts, including the exhaust system. (Even the thermally induced discoloring of stainless-steel exhaust systems can be removed through polishing.)
4. To prevent corrosion, it is recommended to apply a corrosion protection spray on all (even chrome- and nickel-plated) metal surfaces.
5. Use spray oil as a universal cleaner to remove any remaining dirt.
6. Touch up minor paint damage caused by stones, etc.
7. Wax all painted surfaces.
8. Let the motorcycle dry completely before storing it or covering it.

EWA00001

## **! WARNING**

**Make sure that there is no oil or wax on the brakes and tires. If necessary, clean the brake discs and linings with a regular brake disc cleaner or acetone, and wash the tires with warm water and mild soap. Then, carefully test the motorcycle for its braking performance and cornering behavior.**

# MOTORCYCLE CARE AND STORAGE

ECA00013

## CAUTION:

- Apply spray oil and wax sparingly and wipe off any excess.
- Never apply oil or wax on rubber and plastic parts, but treat them with a suitable care product.
- Avoid using abrasive polishing compounds as they wear away the paint.

## NOTE:

Consult a Yamaha dealer for advice on what products to use.

## Storage

### Short-term

Always store your motorcycle in a cool, dry place and, if necessary, protect it against dust with a porous cover.

ECA00014

## CAUTION:

- Storing the motorcycle in a poorly ventilated room or covering it with a tarp while it is still wet will allow water and humidity to seep in and cause rust.
- To prevent corrosion, avoid damp cellars, stables (because of the presence of ammonia) and areas where strong chemicals are stored.

## Long-term

Before storing your motorcycle for several months:

1. Follow all the instructions in the “Care” section of this chapter.
2. Drain the carburetor float chambers by loosening the drain bolts; this will prevent fuel deposits from building up. Pour the drained fuel into the fuel tank.
3. Only for motorcycles equipped with a fuel cock which has an “OFF” position: Turn the fuel cock to “OFF”.
4. Fill up the fuel tank and add fuel stabilizer (if available) to prevent the fuel tank from rusting and the fuel from deteriorating.
5. Perform the following steps to protect the cylinders, piston rings, etc. from corrosion.
  - a. Remove the spark plug caps and spark plugs.
  - b. Pour a teaspoonful of engine oil into each spark plug bore.

# MOTORCYCLE CARE AND STORAGE

---

---

- c. Install the spark plug caps onto the spark plugs and place the spark plugs on the cylinder head so that the electrodes are grounded. (This will limit sparking during the next step.)
  - d. Turn the engine over several times with the starter. (This will coat the cylinder walls with oil.)
  - e. Remove the spark plug caps from the spark plugs, install the spark plugs and then the spark plug caps.
7. Check and, if necessary, correct the tire air pressure, then raise the motorcycle so that both of its wheels are off the ground. Alternatively, turn the wheels a little every month in order to prevent the tires from becoming degraded in one spot.
  8. Cover up the muffler outlet with a plastic bag to prevent moisture from entering.
  9. Remove the battery and fully charge it. Store it in a cool, dry place and recharge it once a month. Do not store the battery in an excessively cold or warm place (less than 0°C or more than 30°C). For more information, see “Battery storage” in the chapter “PERIODIC MAINTENANCE AND MINOR REPAIRS”.

EWA00003

## WARNING

**When turning the engine over, be sure to ground the spark plug electrodes to prevent damage or injury from sparking.**

6. Lubricate all control cables and the pivoting points of all levers and pedals as well as of the sidestand/centerstand.

**NOTE:** \_\_\_\_\_  
Make any necessary repairs before storing the motorcycle.

---

Specifications ..... 8-1  
HOW TO USE THE CONVERSION TABLE ..... 8-5

## Specifications

<b>Model</b>	<b>FZS600/FZS600SP</b>
<b>Dimensions</b>	
Overall length	2,080 mm (except for N, SF) 2,175 mm (for N, SF)
Overall width	710 mm
Overall height	1,170 mm
Seat height	790 mm
Wheelbase	1,415 mm
Ground clearance	130 mm
Minimum turning radius	2,900 mm
<b>Basic weight (with oil and full fuel tank)</b>	<b>210 kg</b>
<b>Engine</b>	
Engine type	Liquid-cooled 4-stroke, DOHC
Cylinder arrangement	Forward-inclined parallel 4-cylinder
Displacement	599 cm <sup>3</sup>
Bore × Stroke	62.0 × 49.6 mm
Compression ratio	12:1
Starting system	Electric starter
Lubrication system	Wet sump

## Engine oil

Type

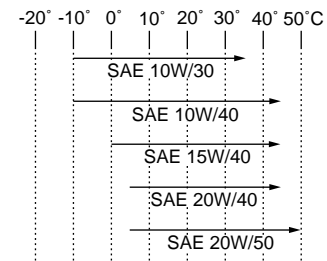

Recommended engine oil classification

API Service SE, SF, SG type or higher

### CAUTION:

**Be sure to use motor oils that do not contain anti-friction modifiers. Passenger car motor oils (often labeled “Energy Conserving”) contain anti-friction additives which will cause clutch and/or starter clutch slippage, resulting in reduced component life and poor engine performance.**

Quantity

Periodic oil change	2.5 L
With oil filter replacement	2.7 L
Total amount	3.5 L

# SPECIFICATIONS

<b>Cooling system total amount</b>	1.95 L
<b>Air filter</b>	Dry type element
<b>Fuel</b>	
Type	Regular unleaded gasoline
Fuel tank capacity	20 L
Fuel reserve amount	3.5 L
<b>Carburetor</b>	
Type × quantity	BSR33 × 4
Manufacturer	MIKUNI
<b>Spark plug</b>	
Manufacturer/Type	
Except for D, F	NGK / CR8E, CR9E or DENSO / U24ESR-N, U27ESR-N
For D, F	NGK / CR7E, CR8E, CR9E or DENSO / U22ESR-N, U24ESR-N, U27ESR-N
Gap	0.7 ~ 0.8 mm
<b>Clutch type</b>	Wet, multiple-disc
<b>Transmission</b>	
Primary reduction system	Spur gear
Primary reduction ratio	1.708
Secondary reduction system	Chain drive
Secondary reduction ratio	3.200

Number of drive chain sprocket teeth (rear/front)	48/15
Transmission type	Constant mesh 6-speed
Operation	Left foot operation
Gear ratio	
	1st 2.846
	2nd 1.947
	3rd 1.545
	4th 1.333
	5th 1.190
	6th 1.074

## Chassis

Frame type	Double cradle
Caster angle	24°
Trail	88 mm

## Tires

Front	
Type	Tubeless
Size	110 / 70 ZR17 (54W)
Manufacturer/ model	Bridgestone / BT-57F Dunlop / D207F Metzeler / MEZ1 FRONT Michelin / MACADAM 90X



# SPECIFICATIONS

## Rear

Type	Tubeless
Size	160 / 60 ZR17 (69W)
Manufacturer/ model	Bridgestone / BT-57R Dunlop / D207J Metzeler / MEZ1 Michelin / MACADAM 90X

Maximum load\* 187 kg

Air pressure (cold tire)

Up to 90 kg load\*

Front	225 kPa (2.25 kg/cm <sup>2</sup> , 2.25 bar)
Rear	250 kPa (2.50 kg/cm <sup>2</sup> , 2.50 bar)

90 kg load ~ maximum load\*

Front	225 kPa (2.25 kg/cm <sup>2</sup> , 2.25 bar)
Rear	290 kPa (2.90 kg/cm <sup>2</sup> , 2.90 bar)

High speed riding

Front	225 kPa (2.25 kg/cm <sup>2</sup> , 2.25 bar)
Rear	290 kPa (2.90 kg/cm <sup>2</sup> , 2.90 bar)

\* Load is total weight of cargo, rider, passenger and accessories.

## Wheels

### Front

Type	Cast
Size	17 × MT 3.00

## Rear

Type	Cast
Size	17 × MT 5.00

## Brakes

### Front

Type	Dual disc brake
Operation	Right hand operation
Fluid	DOT 4

### Rear

Type	Single disc brake
Operation	Right foot operation
Fluid	DOT 4

## Suspension

### Front

Type	Telescopic fork
------	-----------------

### Rear

Type	Swingarm (link suspension)
------	----------------------------

## Shock absorbers

Front	Coil spring / oil damper
Rear	Coil spring / gas-oil damper

## Wheel travel

Front	120 mm
Rear	120 mm

### Electrical system

Ignition system	T.C.I. (digital)
Charging system	
Type	A.C. magneto
Standard output	14 V, 18 A @ 5,000 r/min
Battery	
Type	GT12B-4
Voltage, capacity	12 V, 10 AH

### Headlight type

Quartz bulb (halogen)

### Bulb voltage, wattage × quantity

Headlight	12 V, 60/55 W × 1
	12 V, 55 W × 1
Auxiliary light	12 V, 5 W × 1
Tail/brake light	12 V, 5/21 W × 2
Turn signal light	12 V, 21 W × 4
Meter light	12 V, 2 W × 3
Neutral indicator light	14 V, 1.4 W × 1
High beam indicator light	14 V, 1.4 W × 1
Oil level indicator light	14 V, 1.4 W × 1
Turn indicator light	14 V, 1.4 W × 2
Fuel indicator light	12 V, 2 W × 1
Coolant temperature indicator light	LED

### Fuses

Main fuse	30 A
Headlight fuse	20 A
Signaling system fuse	20 A
Ignition fuse	20 A
Radiator fan fuse	10 A
Parking/Hazard lights fuse	10 A
Odometer fuse	5 A

# SPECIFICATIONS

EAU01064

## HOW TO USE THE CONVERSION TABLE

All specification data in this manual are listed in SI and METRIC UNITS.

Use this table to convert METRIC unit data to IMPERIAL unit data.

Ex.

METRIC		MULTIPLIER	=	IMPERIAL
**mm	×	0.03937	=	**in
2 mm	×	0.03937	=	0.08 in

## CONVERSION TABLE

METRIC TO IMPERIAL			
	Metric unit	Multiplier	Imperial unit
Torque	m-kg	7.233	ft-lb
	m-kg	86.794	in-lb
	cm-kg	0.0723	ft-lb
	cm-kg	0.8679	in-lb
Weight	kg	2.205	lb
	g	0.03527	oz
Speed	km/hr	0.6214	mph
Distance	km	0.6214	mi
	m	3.281	ft
	m	1.094	yd
	cm	0.3937	in
	mm	0.03937	in
Volume / Capacity	cc (cm <sup>3</sup> )	0.03527	oz (IMP liq.)
	cc (cm <sup>3</sup> )	0.06102	cu-in
	lt (liter)	0.8799	qt (IMP liq.)
	lt (liter)	0.2199	gal (IMP liq.)
Misc.	kg/mm	55.997	lb/in
	kg/cm <sup>2</sup>	14.2234	psi (lb/in <sup>2</sup> )
	Centigrade (°C)	9/5 + 32	Fahrenheit (°F)

Identification number records.....	9-1
Key identification number .....	9-1
Vehicle identification number.....	9-1
Model label.....	9-2

## Identification number records

EAU02944

Record the key identification number, vehicle identification number and model label information in the spaces provided for assistance when ordering spare parts from a Yamaha dealer or for reference in case the vehicle is stolen.

### 1. KEY IDENTIFICATION NUMBER:

### 2. VEHICLE IDENTIFICATION NUMBER:

### 3. MODEL LABEL INFORMATION:

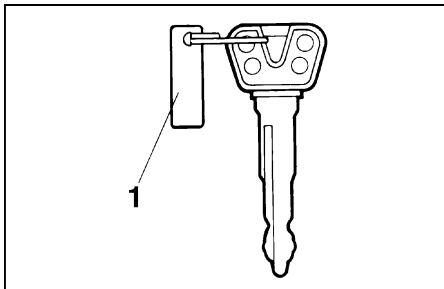

1. Key identification number

EAU01041

## Key identification number

The key identification number is stamped on the key tag. Record this number in the space provided and use it for reference when obtaining a new key.

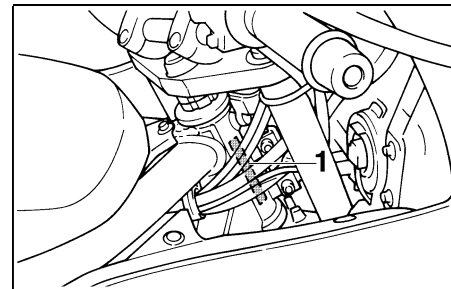

1. Vehicle identification number

EAU01043

## Vehicle identification number

The vehicle identification number is stamped into the steering head pipe. Record this number in the space provided.

### NOTE: \_\_\_\_\_

The vehicle identification number is used to identify your motorcycle and may be used to register your motorcycle with the licensing authority in your state.

---

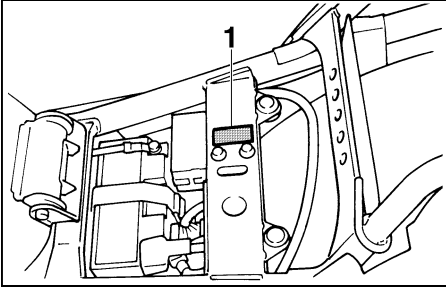

1. Model label

EAU01050

## Model label

The model label is affixed to the frame under the seat. (See page 3-14 for seat removal procedures.) Record the information on this label in the space provided. This information will be needed to order spare parts from your Yamaha dealer.

# INDEX

## A

- Air filter .....6-15
- Antitheft alarm (optional) .....3-8

## B

- Battery .....6-31
- Brake and clutch lever lubrication.....6-29
- Brake and shift pedal lubrication .....6-29
- Brake fluid replacement .....6-26
- Brake light switch adjustment.....6-24

## C

- Cable inspection and lubrication .....6-28
- Carburetor adjustment .....6-18
- Care .....7-1
- Center and sidestand lubrication .....6-29
- Changing the coolant .....6-13
- Checking the front and rear brake pads .....6-25
- Clutch lever .....3-10
- Clutch lever free play adjustment .....6-23
- Controls/Instruments .....2-3
- Coolant temperature indicator light.....3-3
- Cooling system .....6-12

## D

- Diagnosis device .....3-7
- Dimmer switch .....3-9
- Drive chain lubrication .....6-28
- Drive chain slack adjustment.....6-27
- Drive chain slack check.....6-27

## E

- Engine break-in .....5-5
- Engine oil .....6-9
- Engine stop switch.....3-10

## F

- Front brake lever .....3-11
- Front fork adjustment.....3-16
- Front fork inspection .....6-30
- Front wheel installation .....6-36
- Front wheel removal .....6-35
- Fuel .....3-13
- Fuel gauge .....3-8
- Fuel indicator circuit check.....3-5
- Fuel indicator light .....3-3
- Fuel tank breather hose.....3-13
- Fuel tank cap.....3-12
- Fuse replacement.....6-33

## G

- Give safety the right of way .....1-1

## H

- Handlebar switches .....3-9
  - Dimmer switch .....3-9
  - Engine stop switch .....3-10
  - Hazard switch .....3-9
  - Horn switch .....3-9
  - Lights switch .....3-10
  - Pass switch .....3-9
  - Start switch .....3-10
  - Turn signal switch .....3-9
- Hazard switch .....3-9
- Headlight bulb replacement .....6-33

- Helmet holder.....3-15
- High beam indicator light.....3-3
- Horn switch .....3-9

## I

- Identification number records .....9-1
- Idle speed adjustment .....6-18
- Indicator lights .....3-3
  - Coolant temperature indicator light .....3-3
  - Fuel indicator light.....3-3
  - High beam indicator light .....3-3
  - Neutral indicator light .....3-3
  - Oil level indicator light .....3-3
  - Turn indicator lights .....3-3
- Inspecting the brake fluid level .....6-25

## K

- Key identification number .....9-1

## L

- Left view .....2-1
- Lights switch .....3-10
- Luggage strap holders .....3-17

## M

- Main switch/Steering lock.....3-1
- Model label .....9-2

## N

- Neutral indicator light .....3-3

## O

- Oil level indicator circuit check .....3-4
- Oil level indicator light .....3-3

## P

Panel A, C .....	6-5
Panel B.....	6-6
Panel removal and installation .....	6-5
Parking.....	5-6
Pass switch .....	3-9
Periodic maintenance and lubrication .....	6-2
Pre-operation check list .....	4-1

## R

Rear brake pedal .....	3-11
Rear brake pedal height check .....	6-23
Rear shock absorber adjustment .....	3-17
Rear suspension lubrication.....	6-30
Rear wheel installation.....	6-38
Rear wheel removal.....	6-37
Recommended shift points (for Switzerland only).....	5-5
Right view.....	2-2

## S

Seat.....	3-14
Shifting .....	5-4
Shift pedal .....	3-11
Sidestand .....	3-18
Sidestand/clutch switch operation check .....	3-19
Spark plugs .....	6-7
Specifications .....	8-1
Speedometer.....	3-6
Starter (choke) “\” .....	3-14
Starting a warm engine.....	5-4
Starting the engine .....	5-1
Start switch.....	3-10

Steering inspection.....	6-31
Storage .....	7-4
Storage compartment.....	3-15

## T

Tachometer.....	3-7
Taillight bulb replacement .....	6-35
Throttle cable and grip lubrication.....	6-28
Throttle cable free play inspection.....	6-19
Tips for reducing fuel consumption.....	5-5
Tires.....	6-19
Tool kit .....	6-1
Troubleshooting .....	6-39
Troubleshooting chart .....	6-40
Turn indicator lights.....	3-3
Turn signal light bulb replacement.....	6-35
Turn signal switch .....	3-9

## V

Valve clearance adjustment .....	6-19
Vehicle identification number.....	9-1

## W

Wheel bearings .....	6-31
Wheels.....	6-22





PRINTED ON RECYCLED PAPER

PRINTED IN JAPAN  
99 · 10 - 0.3 × 1 CR  
(E)