



**OWNER'S MANUAL**

**Fazer**

**FZS600  
FZS600SP  
5DM-28199-E4**



Welcome to the Yamaha world of motorcycling!

As the owner of an FZS600/FZS600SP, you are benefiting from Yamaha's vast experience and newest technology regarding the design and manufacture of high-quality products, which have earned Yamaha a reputation for dependability.

Please take the time to read this manual thoroughly, so as to enjoy all advantages of your FZS600/FZS600SP. The owner's manual does not only instruct you in how to operate, inspect and maintain your motorcycle, but also in how to safeguard yourself and others from trouble and injury.

In addition, the many tips given in this manual will help keep your motorcycle in the best possible condition. If you have any further questions, do not hesitate to contact your Yamaha dealer.

The Yamaha team wishes you many safe and pleasant rides. So, remember to put safety first!

# IMPORTANT MANUAL INFORMATION

---

---

Particularly important information is distinguished in this manual by the following notations:



The Safety Alert Symbol means **ATTENTION! BECOME ALERT! YOUR SAFETY IS INVOLVED!**



Failure to follow **WARNING** instructions could result in severe injury or death to the motorcycle operator, a bystander, or a person inspecting or repairing the motorcycle.

**CAUTION:**

A **CAUTION** indicates special precautions that must be taken to avoid damage to the motorcycle.

**NOTE:**

A **NOTE** provides key information to make procedures easier or clearer.

**NOTE:** \_\_\_\_\_

- This manual should be considered a permanent part of this motorcycle and should remain with it even if the motorcycle is subsequently sold.
  - Yamaha continually seeks advancements in product design and quality. Therefore, while this manual contains the most current product information available at the time of printing, there may be minor discrepancies between your motorcycle and this manual. If you have any questions concerning this manual, please consult your Yamaha dealer.
-



# IMPORTANT MANUAL INFORMATION

---

---

EW000002

## **WARNING**

**PLEASE READ THIS MANUAL CAREFULLY AND COMPLETELY BEFORE OPERATING THIS MOTORCYCLE.**

---

# **IMPORTANT MANUAL INFORMATION**

---

---

EAU03337

**FZS600/FZS600SP  
OWNER'S MANUAL  
© 2000 by Yamaha Motor Co., Ltd.  
1st Edition, May 2000  
All rights reserved.  
Any reprinting or unauthorized use  
without the written permission of  
Yamaha Motor Co., Ltd.  
is expressly prohibited.  
Printed in Japan.**

|   |   |
|---|---|
| 1 GIVE SAFETY THE RIGHT OF WAY          | 1 |
| 2 DESCRIPTION                           | 2 |
| 3 INSTRUMENT AND CONTROL FUNCTIONS      | 3 |
| 4 PRE-OPERATION CHECKS                  | 4 |
| 5 OPERATION AND IMPORTANT RIDING POINTS | 5 |
| 6 PERIODIC MAINTENANCE AND MINOR REPAIR | 6 |
| 7 MOTORCYCLE CARE AND STORAGE           | 7 |
| 8 SPECIFICATIONS                        | 8 |
| 9 CONSUMER INFORMATION                  | 9 |
| INDEX                                   |   |





# GIVE SAFETY THE RIGHT OF WAY

---

---

GIVE SAFETY THE RIGHT OF WAY ..... 1-1



Motorcycles are fascinating vehicles, which can give you an unsurpassed feeling of power and freedom. However, they also impose certain limits, which you must accept; even the best motorcycle does not ignore the laws of physics.

Regular care and maintenance are essential for preserving value and operating condition of your motorcycle. Moreover, what is true for the motorcycle is also true for the rider: good performance depends on being in good shape. Riding under the influence of medication, drugs and alcohol is, of course, out of the question. Motorcycle riders—more than car drivers—must always be at their mental and physical best. Under the influence of even small amounts of alcohol, there is a tendency to take dangerous risks.

Protective clothing is as essential for the motorcycle rider as seat belts are for car drivers and passengers. Always wear a complete motorcycle suit (whether made of leather or tear-resistant synthetic materials with protectors), sturdy boots, motorcycle gloves and a properly fitting helmet. Optimum protective wear, however, should not encourage carelessness. Although full-coverage helmets and suits, in particular, create an illusion of total safety and protection, motorcyclists will always be vulnerable. Riders who lack critical self-control run the risk of going too fast and are apt to take chances. This is even more dangerous in wet weather. The good motorcyclist rides safely, predictably and defensively—avoiding all dangers, including those caused by others.

Enjoy your ride!

|                                |     |
|--------------------------------|-----|
| Left view .....                | 2-1 |
| Right view.....                | 2-2 |
| Controls and instruments ..... | 2-3 |

## Left view

2

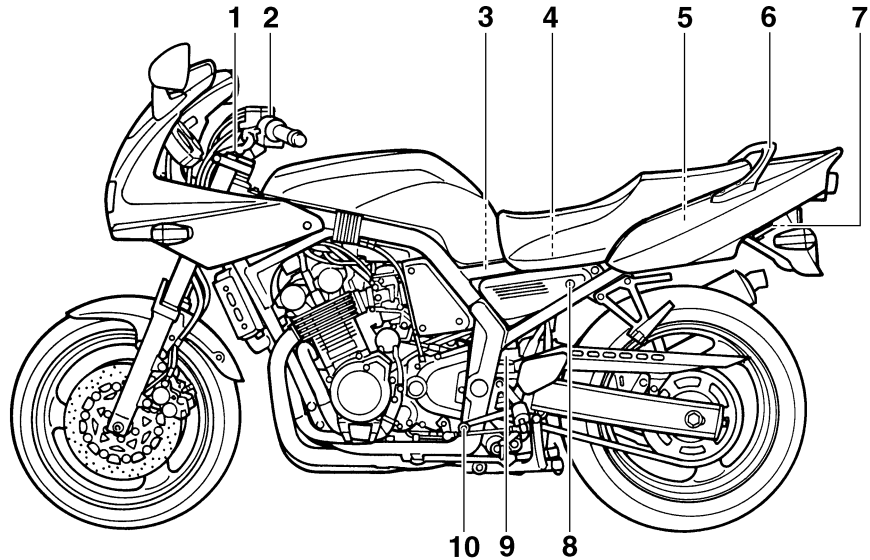

- |   |             |   |             |
|---|-------------|---|-------------|
| 1. Front fork spring preload adjusting bolt | (page 3-13) | 7. Luggage strap holder                                 | (page 3-15) |
| 2. Starter (choke) lever                    | (page 3-12) | 8. Seat lock  | (page 3-12) |
| 3. Air filter element                       | (page 6-17) | 9. Rear shock absorber spring preload<br>adjusting ring | (page 3-14) |
| 4. Fuses                                    | (page 6-36) | 10. Shift pedal   | (page 3-9)  |
| 5. Storage compartment                      | (page 3-13) |   |             |
| 6. Grab bar                                 |             |   |             |



## Right view

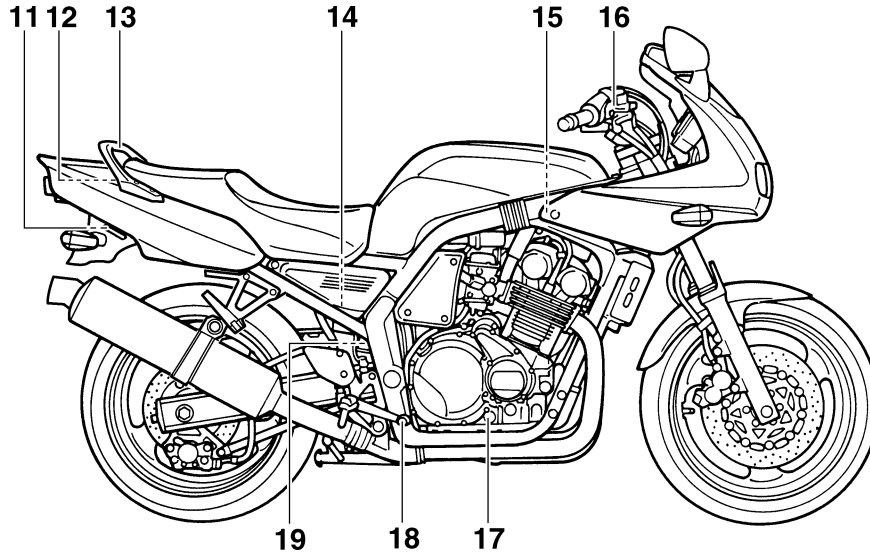

- |                                |             |                                   |             |
|--------------------------------|-------------|-----------------------------------|-------------|
| 11. Luggage strap holder       | (page 3-16) | 16. Front brake master cylinder   | (page 6-27) |
| 12. Tool kit                   | (page 6-1)  | 17. Engine oil level check window | (page 6-9)  |
| 13. Grab bar                   |             | 18. Brake pedal                   | (page 3-9)  |
| 14. Rear brake fluid reservoir | (page 6-27) | 19. Coolant reservoir cap         | (page 6-12) |
| 15. Radiator cap               | (page 6-14) |                                   |             |

# DESCRIPTION

---

---

## Controls and instruments

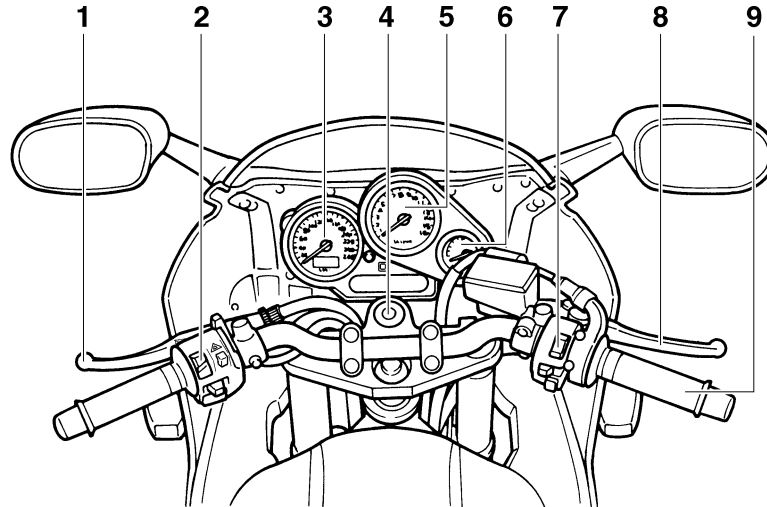

- |                              |             |
|------------------------------|-------------|
| 1. Clutch lever              | (page 3-8)  |
| 2. Left handlebar switches   | (page 3-7)  |
| 3. Speedometer unit          | (page 3-4)  |
| 4. Main switch/steering lock | (page 3-1)  |
| 5. Tachometer                | (page 3-5)  |
| 6. Fuel gauge                | (page 3-6)  |
| 7. Right handlebar switches  | (page 3-8)  |
| 8. Brake lever               | (page 3-9)  |
| 9. Throttle grip             | (page 6-20) |

# INSTRUMENT AND CONTROL FUNCTIONS

|                                    |     |   |      |
|------------------------------------|-----|---|------|
| Main switch/steering lock .....    | 3-1 | Fuel tank cap .....                         | 3-10 |
| Indicator and warning lights ..... | 3-3 | Fuel .....                                  | 3-11 |
| Speedometer unit .....             | 3-4 | Fuel tank breather hose .....               | 3-11 |
| Tachometer .....                   | 3-5 | Starter (choke) lever .....                 | 3-12 |
| Self-diagnosis device .....        | 3-5 | Seat .....                                  | 3-12 |
| Anti-theft alarm (optional) .....  | 3-6 | Storage compartment .....                   | 3-13 |
| Fuel gauge .....                   | 3-6 | Adjusting the front fork .....              | 3-13 |
| Handlebar switches .....           | 3-7 | Adjusting the shock absorber assembly ..... | 3-14 |
| Clutch lever .....                 | 3-8 | Luggage strap holders .....                 | 3-15 |
| Shift pedal .....                  | 3-9 | Sidestand .....                             | 3-15 |
| Brake lever .....                  | 3-9 | Ignition circuit cut-off system .....       | 3-16 |
| Brake pedal .....                  | 3-9 |   |      |

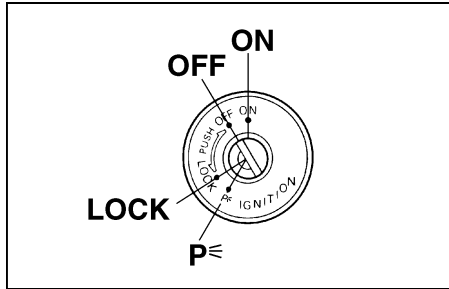

EAU00029

## Main switch/steering lock

The main switch/steering lock controls the ignition and lighting systems, and is used to lock the steering. The various positions are described below.

### ON

EAU00036

All electrical systems are supplied with power, and the engine can be started. The key cannot be removed.

### OFF

EAU00038

All electrical systems are off. The key can be removed.

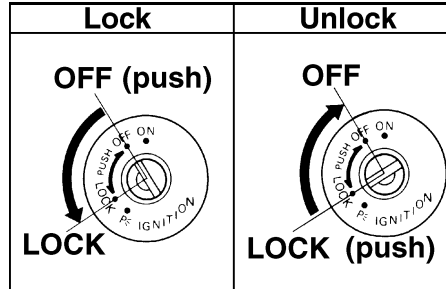

EAU00040

## LOCK

The steering is locked, and all electrical systems are off. The key can be removed.

### To lock the steering

1. Turn the handlebars all the way to the left.
2. Push the key in from the "OFF" position, and then turn it to "LOCK" while still pushing it.
3. Remove the key.

### To unlock the steering

Push the key in, and then turn it to "OFF" while still pushing it.

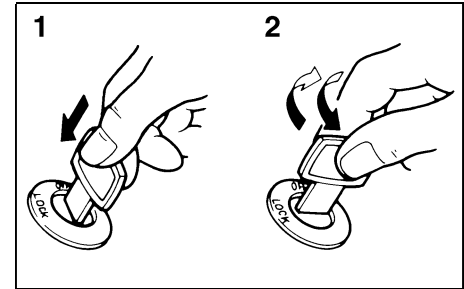

1. Push.
2. Turn.

EW000016

## **! WARNING**

Never turn the key to "OFF" or "LOCK" while the motorcycle is moving, otherwise the electrical systems will be switched off, which may result in loss of control or an accident. Make sure that the motorcycle is stopped before turning the key to "OFF" or "LOCK".

EAU01316

## **P⊘ (Parking)**

The steering is locked, and the taillights and auxiliary light are on, but all other electrical systems are off. The key can be removed.

The steering must be locked before the key can be turned to “P⊘”.

ECA00043





### **CAUTION:**

**Do not use the parking position for an extended length of time, otherwise the battery may discharge.**

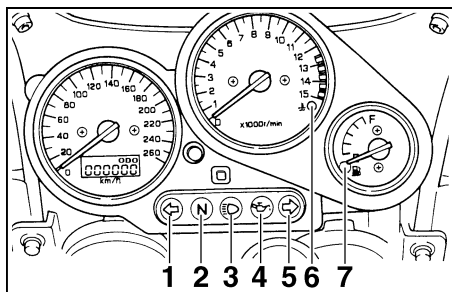
---

# INSTRUMENT AND CONTROL FUNCTIONS



1. Left turn indicator light “”
2. Neutral indicator light “**N**”
3. High beam indicator light “”
4. Oil level warning light “”
5. Right turn indicator light “”
6. Coolant temperature warning light “”
7. Fuel level warning light “”

EAU03034

## Indicator and warning lights

EAU03299

### Turn signal indicator lights “, ”

The corresponding indicator light flashes when the turn signal switch is pushed to the left or right.

EAU00061

### Neutral indicator light “**N**”

This indicator light comes on when the transmission is in the neutral position.

EAU00063

### High beam indicator light “”

This indicator light comes on when the high beam of the headlight is switched on.

EAU03201

### Oil level warning light “”

This warning light comes on when the engine oil level is low.

The electrical circuit of the warning light can be checked according to the following procedure.

1. Set the engine stop switch to “” and turn the key to “ON”.
2. Shift the transmission into the neutral position or pull the clutch lever.
3. Push the start switch. If the warning light does not come on while pushing the start switch, have a Yamaha dealer check the electrical circuit.

## NOTE:

Even if the oil level is sufficient, the warning light may flicker when riding on a slope or during sudden acceleration or deceleration, but this is not a malfunction.

EAU01716

### Coolant temperature warning light “”

This warning light comes on when the engine overheats. When this occurs, stop the engine immediately and allow the engine to cool.

EC000002

## CAUTION:

**Do not operate the engine if it is overheated.**

# INSTRUMENT AND CONTROL FUNCTIONS

EAU03509

## Fuel level warning light “”

This warning light comes on when the fuel level drops below approximately 3.5 L. When this occurs, refuel as soon as possible.

The electrical circuit of the warning light can be checked according to the following procedure.

1. Set the engine stop switch to “” and turn the key to “ON”.
2. Shift the transmission into the neutral position or pull the clutch lever.
3. Push the start switch. If the warning light does not come on, have a Yamaha dealer check the electrical circuit.

### NOTE:

This model is equipped with a self-diagnosis device for the fuel level warning light circuit. (See page 3-5 for an explanation of the self-diagnosis device.)

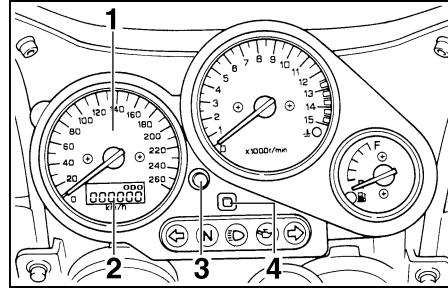

1. Speedometer
2. Odometer/tripmeter/clock
3. “SELECT” button
4. “RESET” button

EAU03028\*

## Speedometer unit

This speedometer unit is equipped with:

- an odometer
- two tripmeters
- a clock

## Odometer and tripmeter modes

When set to “ODO”, the motorcycle’s total mileage is indicated.

When set to “TRIP 1” or “TRIP 2”, the motorcycle’s mileage since the tripmeter was last reset is indicated. Use the tripmeters to estimate how far you can

ride on a tank of fuel. This information will enable you to plan fuel stops in the future.

## To select a mode

Push the “SELECT” button to change between the odometer mode “ODO”, the tripmeter modes “TRIP 1” and “TRIP 2”, and the clock mode in the following order:

“ODO” → “TRIP 1” → “TRIP 2” → Clock → “ODO”

## To reset a meter

To reset either tripmeter 1 or 2 to 0.0, select either by pushing the “SELECT” button and push the “RESET” button for at least one second.

## Clock mode

To change the display to the clock mode, push both the “SELECT” and “RESET” buttons.

To change the display back to the odometer mode, push the “SELECT” button.

# INSTRUMENT AND CONTROL FUNCTIONS

## To set the clock

1. Push both the “SELECT” and “RESET” buttons for at least two seconds.
2. When the hour digits start flashing, push the “RESET” button to set the hours.
3. Push the “SELECT” button to change the minutes.
4. When the minute digits start flashing, push the “RESET” button to set the minutes.
5. Push the “SELECT” button to start the clock.

**NOTE:** \_\_\_\_\_  
After setting the clock, be sure to push the “SELECT” button before turning the main switch to “OFF”, otherwise the clock will not be set.  
\_\_\_\_\_

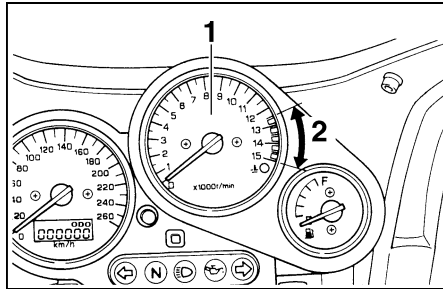

1. Tachometer
2. Red zone

EAU00101

## Tachometer

The electric tachometer allows the rider to monitor the engine speed and keep it within the ideal power range.

EC000003

**CAUTION:** \_\_\_\_\_

**Do not operate the engine in the tachometer red zone.**

**Red zone: 12,500 r/min and above**

EAU01322

## Self-diagnosis device

This model is equipped with a self-diagnosis device for the throttle position sensor circuit.

If the circuit is defective, the tachometer will repeatedly display the following error code:

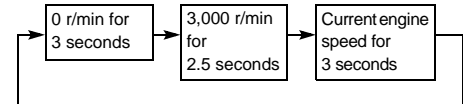

If the tachometer displays such an error code, have a Yamaha dealer check the motorcycle.

EC000004

**CAUTION:** \_\_\_\_\_

**When the tachometer displays an error code, the motorcycle should be checked as soon as possible in order to avoid engine damage.**



# INSTRUMENT AND CONTROL FUNCTIONS

## NOTE:

If the tachometer displays 4,000 r/min instead of 3,000 r/min, the speed sensor may be disconnected or short-circuited. If this occurs, have a Yamaha dealer check the electrical circuit.

## Anti-theft alarm (optional)

EAU00109

This motorcycle can be equipped with an optional anti-theft alarm by a Yamaha dealer. Contact a Yamaha dealer for more information.

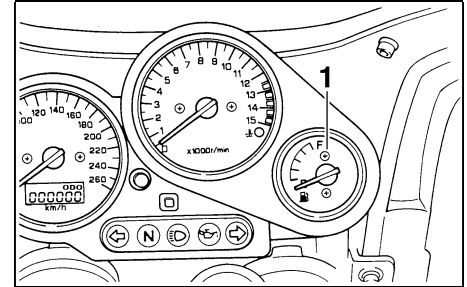

1. Fuel gauge

EAU00110

## Fuel gauge

The fuel gauge indicates the amount of fuel in the fuel tank. The needle moves towards “E” (Empty) as the fuel level decreases. When the needle reaches “E”, approximately 3.5 L of fuel remain in the fuel tank. If this occurs, refuel as soon as possible.

## NOTE:

Do not allow the fuel tank to empty itself completely.

# INSTRUMENT AND CONTROL FUNCTIONS

3

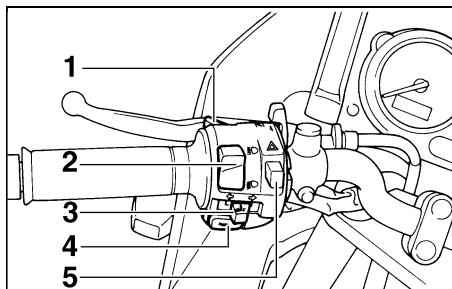

1. Pass switch "PASS"
2. Dimmer switch
3. Turn signal switch
4. Horn switch "📢"
5. Hazard switch "⚠️"

## Handlebar switches

EAU00118

### Pass switch "PASS"

EAU00120

Press this switch to flash the headlight.

EAU00121

### Dimmer switch

Set this switch to "☰" for the high beam and to "☷" for the low beam.

EAU00127

### Turn signal switch

To signal a right-hand turn, push this switch to "↗️". To signal a left-hand turn, push this switch to "↖️". When released, the switch returns to the center position. To cancel the turn signal lights, push the switch in after it has returned to the center position.

EAU00129

### Horn switch "📢"

Press this switch to sound the horn.

EAU00144

### Hazard switch "⚠️"

With the key in the "ON" or "P" position, use this switch to turn on the hazard light (simultaneous flashing of all turn signal lights).

The hazard light is used in case of an emergency or to warn other drivers when your motorcycle is stopped where it might be a traffic hazard.

EC000006

## CAUTION:

**Do not use the hazard light for an extended length of time, otherwise the battery may discharge.**

# INSTRUMENT AND CONTROL FUNCTIONS

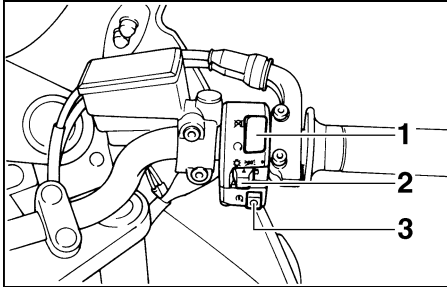

1. Engine stop switch
2. Light switch
3. Start switch “”



EAU00138

## Engine stop switch

Set this switch to “” to stop the engine in case of an emergency, such as when the motorcycle overturns or when the throttle cable is stuck.

EAU00134

## Light switch

Set this switch to “ ” to turn on the auxiliary light, meter lighting and tail-light. Set the switch to “” to turn on the headlight also.

## Start switch “”

Push this switch to crank the engine with the starter.

EAU00143

EC000005

## CAUTION:

See page 5-1 for starting instructions prior to starting the engine.

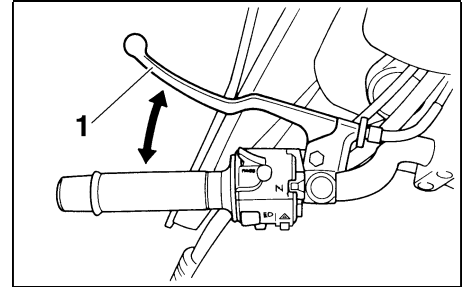

1. Clutch lever

EAU00152

## Clutch lever

The clutch lever is located at the left handlebar grip. To disengage the clutch, pull the lever toward the handlebar grip. To engage the clutch, release the lever. The lever should be pulled rapidly and released slowly for smooth clutch operation.

The clutch lever is equipped with a clutch switch, which is part of the ignition circuit cut-off system. (See page 3-16 for an explanation of the ignition circuit cut-off system.)

# INSTRUMENT AND CONTROL FUNCTIONS

3

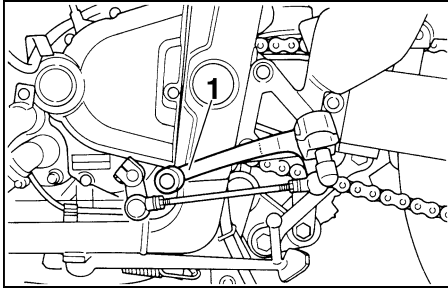

1. Shift pedal

EAU00157

## Shift pedal

The shift pedal is located on the left side of the engine and is used in combination with the clutch lever when shifting the gears of the 6-speed constant-mesh transmission equipped on this motorcycle.

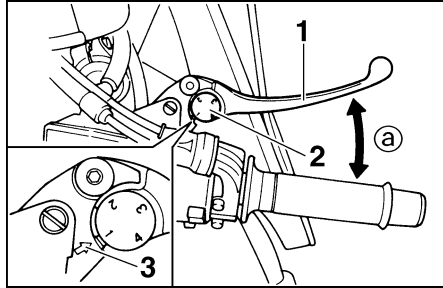

1. Brake lever
  2. Brake lever position adjusting dial
  3. Arrow mark
- a. Distance between brake lever and handlebar grip

EAU00161

## Brake lever

The brake lever is located at the right handlebar grip. To apply the front brake, pull the lever toward the handlebar grip.

The brake lever is equipped with a position adjusting dial. To adjust the distance between the brake lever and the handlebar grip, turn the adjusting dial while holding the lever pushed away from the handlebar grip. Make sure that the appropriate setting on the adjusting dial is aligned with the arrow mark on the brake lever.

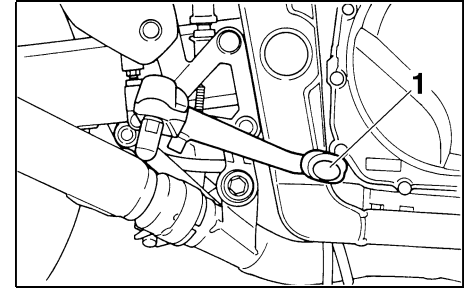

1. Brake pedal

EAU00162

## Brake pedal

The brake pedal is on the right side of the motorcycle. To apply the rear brake, press down on the brake pedal.

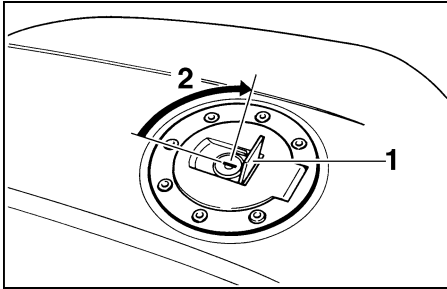

1. Fuel tank lock cover
2. Unlock.

EAU02935

## Fuel tank cap

### To open the fuel tank cap

Open the fuel tank cap lock cover, insert the key into the lock, and then turn it 1/4 turn clockwise. The lock will be released and the fuel tank cap can be opened.

### To close the fuel tank cap

1. Push the fuel tank cap into position with the key inserted in the lock.

2. Turn the key counterclockwise to the original position, remove it, and then close the lock cover.

### NOTE: \_\_\_\_\_

The fuel tank cap cannot be closed unless the key is in the lock. In addition, the key cannot be removed if the cap is not properly closed and locked.

EWA00025

### **WARNING** \_\_\_\_\_

**Make sure that the fuel tank cap is properly closed before riding.**

# INSTRUMENT AND CONTROL FUNCTIONS

3

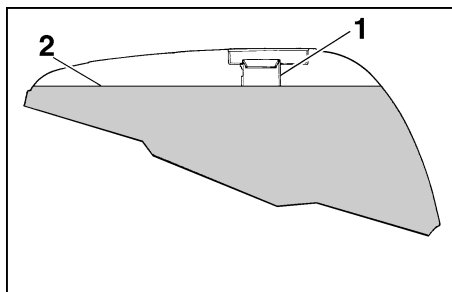

1. Fuel tank filler tube
2. Fuel level

EAU001183

## Fuel

Make sure that there is sufficient fuel in the tank. Fill the fuel tank to the bottom of the filler tube as shown in the illustration.

EW000130

### **! WARNING**

- Do not overfill the fuel tank, otherwise it may overflow when the fuel warms up and expands.
- Avoid spilling fuel on the hot engine.

EAU00185

### **CAUTION:**

Immediately wipe off spilled fuel with a clean, dry, soft cloth, since fuel may deteriorate painted surfaces or plastic parts.

EAU00191

### Recommended fuel:

Regular unleaded gasoline with a research octane number of 91 or higher

### Fuel tank capacity:

Total amount:

20 L

Reserve amount:

3.5 L

### **NOTE:**

If knocking (or pinging) occurs, use gasoline of a different brand or with a higher octane grade.

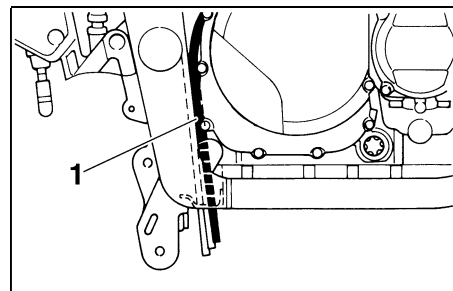

1. Fuel tank breather hose

EAU02955

## Fuel tank breather hose

Before operating the motorcycle:

- Check the fuel tank breather hose connection.
- Check the fuel tank breather hose for cracks or damage, and replace it if damaged.
- Make sure that the end of the fuel tank breather hose is not blocked, and clean it if necessary.

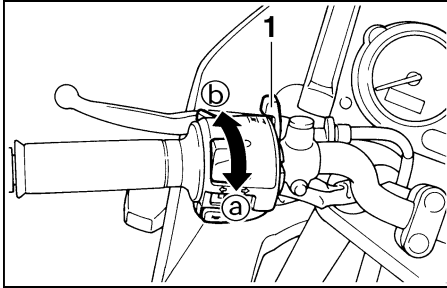

1. Starter (choke) lever

EAU02976

## Starter (choke) lever

Starting a cold engine requires a richer air-fuel mixture, which is supplied by the starter (choke).

Move the lever in direction **a** to turn on the starter (choke).

Move the lever in direction **b** to turn off the starter (choke).

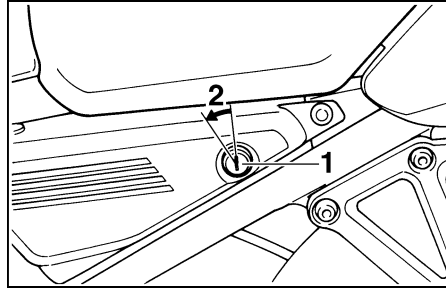

1. Seat lock  
2. Unlock.

## Seat

EAU01319

### To remove the seat

1. Insert the key into the seat lock, and then turn it counterclockwise.
2. While holding the key in that position, lift the front of the seat up, and then pull the seat off.

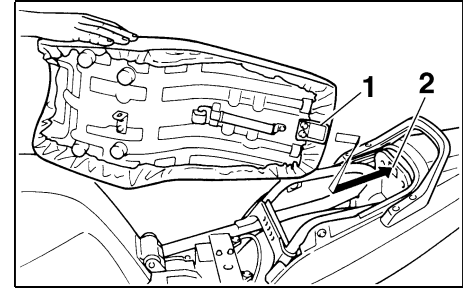

1. Projection  
2. Seat holder

### To install the seat

1. Insert the projection on the rear of the seat into the seat holder as shown.
2. Push the front of the seat down to lock it in place.
3. Remove the key.

**NOTE:** \_\_\_\_\_  
Make sure that the seat is properly secured before riding.  
\_\_\_\_\_

# INSTRUMENT AND CONTROL FUNCTIONS

3

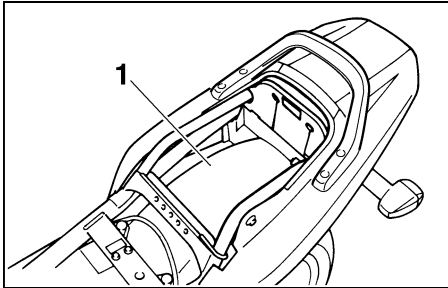

1. Storage compartment

EAU01688

## Storage compartment

This storage compartment is designed to hold a genuine Yamaha U-LOCK. (Other locks may not fit.) When placing a U-LOCK in the storage compartment, securely fasten it with the straps. When the U-LOCK is not in the storage compartment, be sure to secure the straps to prevent losing them.

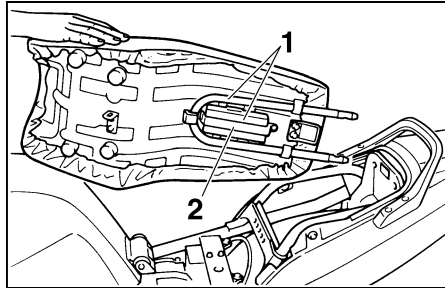

1. U-LOCK  
2. Strap

When storing the owner's manual or other documents in the storage compartment, be sure to wrap them in a plastic bag so that they will not get wet. When washing the motorcycle, be careful not to let any water enter the storage compartment.

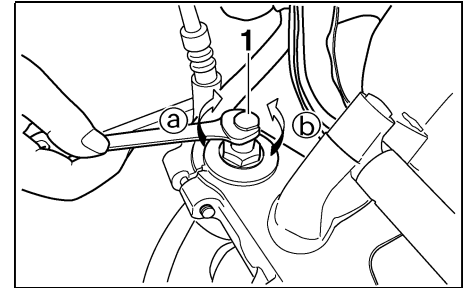

1. Spring preload adjusting bolt

EAU00285

## Adjusting the front fork

This front fork is equipped with spring preload adjusting bolts.

EW000035

### **! WARNING**

**Always adjust both fork legs equally, otherwise poor handling and loss of stability may result.**

Adjust the spring preload as follows.



# INSTRUMENT AND CONTROL FUNCTIONS

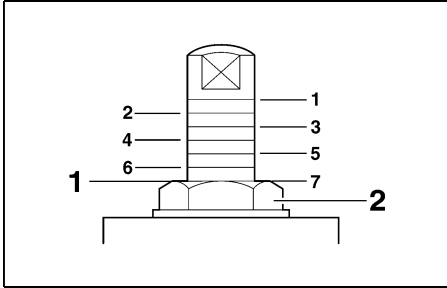

1. Current setting
2. Front fork cap

To increase the spring preload and thereby harden the suspension, turn the adjusting bolt on each fork leg in direction Ⓐ. To decrease the spring preload and thereby soften the suspension, turn the adjusting bolt on each fork leg in direction Ⓑ.

**NOTE:** \_\_\_\_\_  
Align the appropriate groove on the adjusting mechanism with the top of the front fork cap bolt.

|         | Minimum (soft) |   | Standard | Maximum (hard) |   |   |   |
|---------|----------------|---|----------|----------------|---|---|---|
| Setting | 7              | 6 | 5        | 4              | 3 | 2 | 1 |

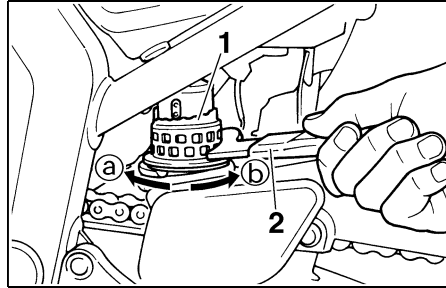

1. Spring preload adjusting ring
2. Special wrench

## Adjusting the shock absorber assembly

This shock absorber assembly is equipped with a spring preload adjusting ring.

**CAUTION:** \_\_\_\_\_  
**Never attempt to turn an adjusting mechanism beyond the maximum or minimum settings.**

Adjust the spring preload as follows. To increase the spring preload and thereby harden the suspension, turn the adjusting ring in direction Ⓐ. To decrease the spring preload and thereby soften the suspension, turn the adjusting ring in direction Ⓑ.

**NOTE:** \_\_\_\_\_  
Align the appropriate notch in the adjusting ring with the position indicator on the shock absorber.

|         | Minimum (soft) |   |   | Standard | Maximum (hard) |   |   |   |   |
|---------|----------------|---|---|----------|----------------|---|---|---|---|
| Setting | 1              | 2 | 3 | 4        | 5              | 6 | 7 | 8 | 9 |

# INSTRUMENT AND CONTROL FUNCTIONS

EAU00315

## **⚠ WARNING**

This shock absorber contains highly pressurized nitrogen gas. For proper handling, read and understand the following information before handling the shock absorber. The manufacturer cannot be held responsible for property damage or personal injury that may result from improper handling.

- Do not tamper with or attempt to open the gas cylinder.
- Do not subject the shock absorber to an open flame or other high heat sources, otherwise it may explode due to excessive gas pressure.
- Do not deform or damage the gas cylinder in any way, as this will result in poor damping performance.
- Always have a Yamaha dealer service the shock absorber.

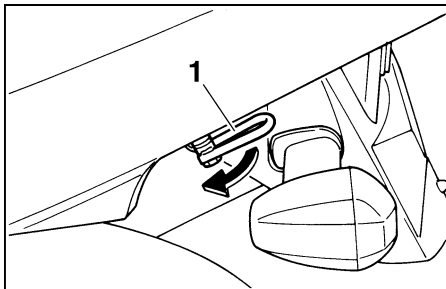

1. Luggage strap holder (x 2)

EAU01311

## **Luggage strap holders**

There are two luggage strap holders below the rear of the seat, which can be turned out for easier access.

EAU00330

## **Sidestand**

The sidestand is located on the left side of the frame. Raise the sidestand or lower it with your foot while holding the motorcycle upright.

## **NOTE:**

The built-in sidestand switch is part of the ignition circuit cut-off system, which cuts the ignition in certain situations. (See further down for an explanation of the ignition circuit cut-off system.)

EW000044

EAU00332

EW000046

## **WARNING**

The motorcycle must not be ridden with the sidestand down, or if the sidestand cannot be properly moved up (or does not stay up), otherwise the sidestand could contact the ground and distract the operator, resulting in a possible loss of control. Yamaha's ignition circuit cut-off system has been designed to assist the operator in fulfilling the responsibility of raising the sidestand before starting off. Therefore, check this system regularly as described below and have a Yamaha dealer repair it if it does not function properly.

## **Ignition circuit cut-off system**

The ignition circuit cut-off system (comprising the sidestand switch, clutch switch and neutral switch) has the following functions.

- It prevents starting when the transmission is in gear and the sidestand is up, but the clutch lever is not pulled.
- It prevents starting when the transmission is in gear and the clutch lever is pulled, but the sidestand is still down.
- It cuts the running engine when the sidestand is moved down.

Periodically check the operation of the ignition circuit cut-off system according to the following procedure.

## **WARNING**

- The vehicle must be placed on the centerstand during this inspection.
- If a malfunction is noted, have a Yamaha dealer check the system before riding.

# INSTRUMENT AND CONTROL FUNCTIONS

3

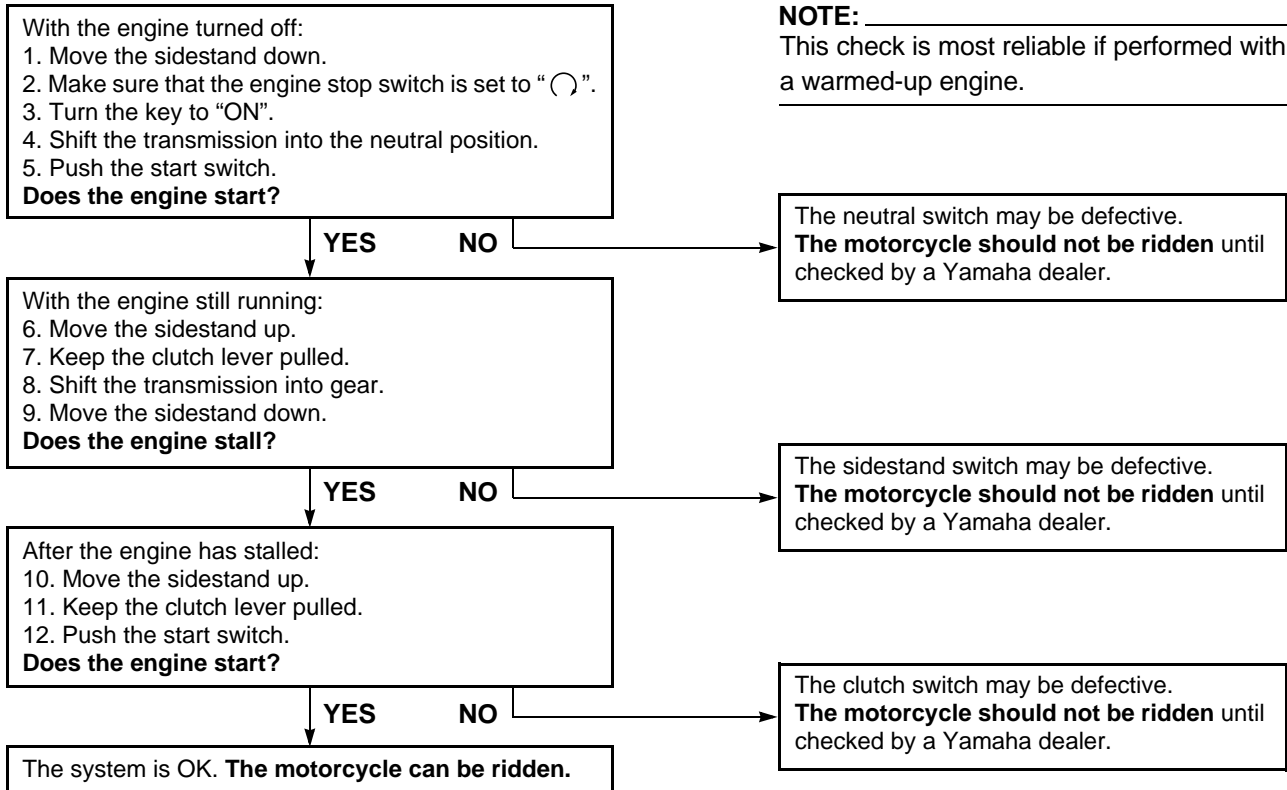

Pre-operation check list ..... 4-1

# PRE-OPERATION CHECKS

The condition of a vehicle is the owner's responsibility. Vital components can start to deteriorate quickly and unexpectedly, even if the vehicle remains unused (for example, as a result of exposure to the elements). Any damage, fluid leakage or loss of tire air pressure could have serious consequences. Therefore, it is very important, in addition to a thorough visual inspection, to check the following points before each ride.

## Pre-operation check list

| ITEM                          | CHECKS   | PAGE                   |
|-------------------------------|--|------------------------|
| Front brake                   | <ul style="list-style-type: none"><li>• Check operation, free play, fluid level and fluid leakage.</li><li>• Fill with DOT 4 brake fluid if necessary.</li></ul> | 6-25–6-28              |
| Rear brake                    |  |                        |
| Clutch                        | <ul style="list-style-type: none"><li>• Check operation condition and free play.</li><li>• Adjust if necessary.</li></ul>  | 6-24–6-25              |
| Throttle grip and housing     | <ul style="list-style-type: none"><li>• Check for smooth operation.</li><li>• Lubricate if necessary.</li></ul>  | 6-20, 6-30             |
| Engine oil                    | <ul style="list-style-type: none"><li>• Check oil level.</li><li>• Fill with oil if necessary.</li></ul>   | 6-9–6-12               |
| Coolant reservoir tank        | <ul style="list-style-type: none"><li>• Check coolant level.</li><li>• Fill with coolant if necessary.</li></ul>   | 6-12–6-16              |
| Drive chain                   | <ul style="list-style-type: none"><li>• Check chain slack and condition.</li><li>• Adjust if necessary.</li></ul>  | 6-28–6-30              |
| Wheels and tires              | <ul style="list-style-type: none"><li>• Check tire pressure, wear and damage.</li></ul>  | 6-21–6-24<br>6-39–6-42 |
| Control cables                | <ul style="list-style-type: none"><li>• Check smooth operation.</li><li>• Lubricate if necessary.</li></ul>  | 6-30                   |
| Brake and shift pedal shafts  | <ul style="list-style-type: none"><li>• Check smooth operation.</li><li>• Lubricate if necessary.</li></ul>  | 6-31                   |
| Brake and clutch lever pivots | <ul style="list-style-type: none"><li>• Check smooth operation.</li><li>• Lubricate if necessary.</li></ul>  | 6-32                   |

# PRE-OPERATION CHECKS

| ITEM                                | CHECKS  | PAGE      |
|-------------------------------------|---|-----------|
| <b>Center and sidestand pivots</b>  | <ul style="list-style-type: none"><li>• Check smooth operation.</li><li>• Lubricate if necessary.</li></ul>   | 6-32      |
| <b>Chassis fasteners</b>            | <ul style="list-style-type: none"><li>• Make sure that all nuts, bolts and screws are properly tightened.</li><li>• Tighten if necessary.</li></ul> | —         |
| <b>Fuel</b>                         | <ul style="list-style-type: none"><li>• Check fuel level.</li><li>• Fill with fuel if necessary.</li></ul>  | 3-10–3-11 |
| <b>Lights, signals and switches</b> | <ul style="list-style-type: none"><li>• Check proper operation.</li></ul>   | —         |

**NOTE:**

Pre-operation checks should be made each time the motorcycle is used. Such an inspection can be accomplished in a very short time; and the added safety it assures is more than worth the time involved.

EWA00033

 **WARNING**

If any item in the Pre-operation check list is not working properly, have it inspected and repaired before operating the motorcycle.





# OPERATION AND IMPORTANT RIDING POINTS

---

|   |     |
|---|-----|
| Starting a cold engine .....                          | 5-1 |
| Starting a warm engine .....                          | 5-3 |
| Shifting .....  | 5-3 |
| Recommended shift points (for Switzerland only) ..... | 5-4 |
| Tips for reducing fuel consumption .....              | 5-4 |
| Engine break-in .....                                 | 5-4 |
| Parking .....   | 5-5 |

EAU00373

**⚠ WARNING**

- Become thoroughly familiar with all operating controls and their functions before riding. Consult a Yamaha dealer regarding any control or function that you do not thoroughly understand.
- Never start the engine or operate it in a closed area for any length of time. Exhaust fumes are poisonous, and inhaling them can cause loss of consciousness and death within a short time. Always make sure that there is adequate ventilation.
- Before starting out, make sure that the sidestand is up. If the sidestand is not raised completely, it could contact the ground and distract the operator, resulting in a possible loss of control.

## Starting a cold engine

In order for the ignition circuit cut-off system to enable starting, one of the following conditions must be met:

- The transmission is in the neutral position.
- The transmission is in gear with the clutch lever pulled and the sidestand up.

EAU01627

EW000054

**⚠ WARNING**

- Before starting the engine, check the function of the ignition circuit cut-off system according to the procedure described on page 3-16.
- Never ride with the sidestand down.

1. Turn the key to “ON” and make sure that the engine stop switch is set to “”.

EC000035

**CAUTION:**

**If the fuel level warning light comes on, check the fuel level, and, if necessary, refuel as soon as possible.**

2. Shift the transmission into the neutral position.

**NOTE:**

When the transmission is in the neutral position, the neutral indicator light should be on, otherwise have a Yamaha dealer check the electrical circuit.

3. Turn the starter (choke) on and completely close the throttle. (See page 3-12 for starter (choke) operation.)
4. Start the engine by pushing the start switch.

# OPERATION AND IMPORTANT RIDING POINTS

## NOTE:

If the engine fails to start, release the start switch, wait a few seconds, and then try again. Each starting attempt should be as short as possible to preserve the battery. Do not crank the engine more than 10 seconds on any one attempt.

EC000038

## CAUTION:

- The oil level warning light and fuel level warning light should come on when the start switch is pushed, and they should go off when the start switch is released.
- If the oil level warning light flickers or remains on after starting, immediately stop the engine, and then check the engine oil level and the vehicle for oil leakage. If necessary, add engine oil, and then check the warning light again. If the warning light does not come on when pushing the start switch, or if it does

not go off after starting with sufficient engine oil, have a Yamaha dealer check the electrical circuit.

- If the fuel level warning light remains on after starting, stop the engine, and then check the fuel level. If necessary, refuel as soon as possible, and then check the warning light again. If the warning light does not come on when pushing the start switch, or if it does not go off after starting with sufficient fuel, have a Yamaha dealer check the electrical circuit.

5. After starting the engine, move the starter (choke) knob/lever back halfway.

ECA00045

## CAUTION:

For maximum engine life, never accelerate hard when the engine is cold!

6. When the engine is warm, turn the starter (choke) off.

## NOTE:

The engine is warm when it responds normally to the throttle with the starter (choke) turned off.

# OPERATION AND IMPORTANT RIDING POINTS

## Starting a warm engine

Follow the same procedure as for starting a cold engine with the exception that the starter (choke) is not required when the engine is warm.

EAU01258

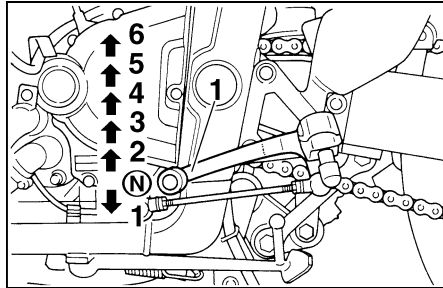

- 1. Shift pedal
- N. Neutral position

EAU00423

## Shifting

Shifting gears lets you control the amount of engine power available for starting off, accelerating, climbing hills, etc.

The gear positions are shown in the illustration.

### NOTE:

To shift the transmission into the neutral position, press the shift pedal down repeatedly until it reaches the end of its travel, and then slightly raise it.

EC000048

### CAUTION:

- Even with the transmission in the neutral position, do not coast for long periods of time with the engine off, and do not tow the motorcycle for long distances. The transmission is properly lubricated only when the engine is running. Inadequate lubrication may damage the transmission.
- Always use the clutch while changing gears to avoid damaging the engine, transmission, and drive train, which are not designed to withstand the shock of forced shifting.

EAU02937

## Recommended shift points (for Switzerland only)

The recommended shift points during acceleration are shown in the table below.

|           | Shift point<br>(km/h) |
|-----------|-----------------------|
| 1st → 2nd | 20                    |
| 2nd → 3rd | 30                    |
| 3rd → 4th | 40                    |
| 4th → 5th | 50                    |
| 5th → 6th | 60                    |

### NOTE:

When shifting down two gears at a time, reduce the speed accordingly (e.g., down to 35 km/h when shifting from 5th to 3rd gear).

EAU00424

## Tips for reducing fuel consumption

Fuel consumption depends largely on your riding style. Consider the following tips to reduce fuel consumption:

- Thoroughly warm up the engine.
- Turn the starter (choke) off as soon as possible.
- Shift up swiftly, and avoid high engine speeds during acceleration.
- Do not rev the engine while shifting down, and avoid high engine speeds with no load on the engine.
- Turn the engine off instead of letting it idle for an extended length of time (e.g., in traffic jams, at traffic lights or at railroad crossings).

EAU01128

## Engine break-in

There is never a more important period in the life of your engine than the period between 0 and 1,600 km. For this reason, you should read the following material carefully.

Since the engine is brand new, do not put an excessive load on it for the first 1,600 km. The various parts in the engine wear and polish themselves to the correct operating clearances. During this period, prolonged full-throttle operation or any condition that might result in engine overheating must be avoided.

# OPERATION AND IMPORTANT RIDING POINTS

---

---

## 0–1,000 km

EAU01329

Avoid prolonged operation above 5,000 r/min.

## 1,000–1,600 km

Avoid prolonged operation above 6,000 r/min.

EC000052

### CAUTION:

After 1,000 km of operation, the engine oil must be changed and the oil filter cartridge/element replaced.

## 1,600 km and beyond

The vehicle can now be operated normally.

EC000053

### CAUTION:

- Keep the engine speed out of the tachometer red zone.
- If any engine trouble should occur during the engine break-in period, immediately have a Yamaha dealer check the vehicle.

## Parking

EAU00460

When parking, stop the engine, and then remove the key from the main switch.

EW000058

### WARNING

- Since the engine and exhaust system can become very hot, park in a place where pedestrians or children are not likely to touch them.
- Do not park on a slope or on soft ground, otherwise the motorcycle may overturn.

# PERIODIC MAINTENANCE AND MINOR REPAIR

|  |      |  |      |
|--|------|--|------|
| Owner's tool kit .....                           | 6-1  | Checking and lubricating the throttle grip and cable .....   | 6-31 |
| Periodic maintenance and lubrication chart ..... | 6-2  | Checking and lubricating the brake and shift pedals .....    | 6-31 |
| Removing and installing panels .....             | 6-5  | Checking and lubricating the brake and clutch levers .....   | 6-32 |
| Checking the spark plugs .....                   | 6-7  | Checking and lubricating the centerstand and sidestand ..... | 6-32 |
| Engine oil and oil filter cartridge .....        | 6-9  | Lubricating the rear suspension .....                        | 6-33 |
| Coolant .....                                    | 6-12 | Checking the front fork .....                                | 6-33 |
| Air filter .....                                 | 6-17 | Checking the steering .....                                  | 6-34 |
| Adjusting the carburetors .....                  | 6-19 | Checking the wheel bearings .....                            | 6-34 |
| Adjusting the engine idling speed .....          | 6-19 | Battery .....  | 6-35 |
| Adjusting the throttle cable free play .....     | 6-20 | Replacing the fuses .....                                    | 6-36 |
| Adjusting the valve clearance .....              | 6-20 | Replacing the headlight bulb .....                           | 6-37 |
| Tires .....                                      | 6-21 | Replacing the tail/brake light bulb .....                    | 6-38 |
| Wheels .....                                     | 6-24 | Replacing a turn signal light bulb .....                     | 6-39 |
| Adjusting the clutch lever free play .....       | 6-24 | Front wheel .....  | 6-39 |
| Adjusting the brake pedal position .....         | 6-25 | Rear wheel .....   | 6-41 |
| Adjusting the rear brake light switch .....      | 6-26 | Troubleshooting .....  | 6-43 |
| Checking the front and rear brake pads .....     | 6-26 | Troubleshooting charts .....                                 | 6-44 |
| Checking the brake fluid level .....             | 6-27 |  |      |
| Changing the brake fluid .....                   | 6-28 |  |      |
| Drive chain slack .....                          | 6-28 |  |      |
| Lubricating the drive chain .....                | 6-29 |  |      |
| Checking and lubricating the cables .....        | 6-30 |  |      |

EAU00464

Safety is an obligation of the owner. Periodic inspection, adjustment and lubrication will keep your vehicle in the safest and most efficient condition possible. The most important points of inspection, adjustment, and lubrication are explained on the following pages. The intervals given in the periodic maintenance and lubrication chart should be simply considered as a general guide under normal riding conditions. However, **DEPENDING ON THE WEATHER, TERRAIN, GEOGRAPHICAL LOCATION, AND INDIVIDUAL USE, THE MAINTENANCE INTERVALS MAY NEED TO BE SHORTENED.**

EW000060

**⚠ WARNING**

**If you are not familiar with motorcycle maintenance work, have a Yamaha dealer do it for you.**

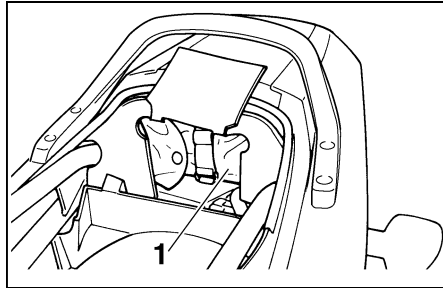

1. Tool kit

EAU01299

## Owner's tool kit

The owner's tool kit is located inside the storage compartment under the seat. (See page 3-12 for seat removal procedures.)

The service information included in this manual and the tools provided in the owner's tool kit are intended to assist you in the performance of preventive maintenance and minor repairs. However, additional tools such as a torque wrench may be necessary to perform certain maintenance work correctly.

**NOTE:**

If you do not have the tools or experience required for a particular job, have a Yamaha dealer perform it for you.

EW000063

**⚠ WARNING**

**Modifications not approved by Yamaha may cause loss of performance and render the vehicle unsafe for use. Consult a Yamaha dealer before attempting any changes.**



# PERIODIC MAINTENANCE AND MINOR REPAIR

EAU03540

## Periodic maintenance and lubrication chart

### NOTE:

- The annual checks must be performed every year, except if a kilometer-based maintenance is performed instead.
- From 50,000 km, repeat the maintenance intervals starting from 10,000 km.
- Items marked with an asterisk should be performed by a Yamaha dealer as they require special tools, data and technical skills.

| NO. | ITEM               | CHECK OR MAINTENANCE JOB   | ODOMETER READING (×1,000 km) |    |    |    |    | Annual check |
|-----|--------------------|--|------------------------------|----|----|----|----|--------------|
|     |                    |  | 1                            | 10 | 20 | 30 | 40 |              |
| 1   | * Fuel line        | • Check fuel hoses for cracks or damage.   |                              | √  | √  | √  | √  | √            |
| 2   | * Fuel filter      | • Check condition.   |                              |    | √  |    | √  |              |
| 3   | Spark plugs        | • Check condition.<br>• Clean and regap.   |                              | √  |    | √  |    |              |
|     |                    | • Replace.   |                              |    | √  |    | √  |              |
| 4   | * Valves           | • Check valve clearance.<br>• Adjust.  | Every 40,000 km              |    |    |    |    |              |
| 5   | Air filter element | • Clean.   |                              | √  |    | √  |    |              |
|     |                    | • Replace.   |                              |    | √  |    | √  |              |
| 6   | Clutch             | • Check operation.<br>• Adjust.  | √                            | √  | √  | √  | √  |              |
| 7   | * Front brake      | • Check operation, fluid level and vehicle for fluid leakage.<br>(See NOTE on page 6-4.) | √                            | √  | √  | √  | √  | √            |
|     |                    | • Replace brake pads.  | Whenever worn to the limit   |    |    |    |    |              |
| 8   | * Rear brake       | • Check operation, fluid level and vehicle for fluid leakage.<br>(See NOTE on page 6-4.) | √                            | √  | √  | √  | √  | √            |
|     |                    | • Replace brake pads.  | Whenever worn to the limit   |    |    |    |    |              |
| 9   | * Brake hoses      | • Check for cracks or damage.  |                              | √  | √  | √  | √  | √            |
|     |                    | • Replace. (See NOTE on page 6-4.)   | Every 4 years                |    |    |    |    |              |

# PERIODIC MAINTENANCE AND MINOR REPAIR

| NO. | ITEM   | CHECK OR MAINTENANCE JOB   | ODOMETER READING (×1,000 km)   |    |    |    |    | Annual check |
|-----|--|--|--|----|----|----|----|--------------|
|     |  |  | 1  | 10 | 20 | 30 | 40 |              |
| 10  | * Wheels   | • Check runout and for damage.   |  | √  | √  | √  | √  |              |
| 11  | * Tires  | • Check tread depth and for damage.<br>• Replace if necessary.<br>• Check air pressure.<br>• Correct if necessary. |  | √  | √  | √  | √  |              |
| 12  | * Wheel bearings   | • Check bearing for looseness or damage.   |  | √  | √  | √  | √  |              |
| 13  | * Swingarm   | • Check operation and for excessive play.  |  | √  | √  | √  | √  |              |
|     |  | • Lubricate with molybdenum disulfide grease.  | Every 50,000km   |    |    |    |    |              |
| 14  | Drive chain  | • Check chain slack.<br>• Make sure that the rear wheel is properly aligned.<br>• Clean and lubricate.             | Every 1,000 km and after washing the motorcycle or riding in the rain. |    |    |    |    |              |
| 15  | * Steering bearings  | • Check bearing play and steering for roughness.   | √  | √  | √  | √  | √  |              |
|     |  | • Lubricate with lithium-soap-based grease.  | Every 20,000km   |    |    |    |    |              |
| 16  | * Chassis fasteners  | • Make sure that all nuts, bolts and screws are properly tightened.  |  | √  | √  | √  | √  | √            |
| 17  | Sidestand/centerstand  | • Check operation.<br>• Lubricate.   |  | √  | √  | √  | √  | √            |
| 18  | * Sidestand switch   | • Check operation.   | √  | √  | √  | √  | √  | √            |
| 19  | * Front fork   | • Check operation and for oil leakage.   |  | √  | √  | √  | √  |              |
| 20  | * Rear shock absorber assembly                                 | • Check operation and shock absorber for oil leakage.  |  | √  | √  | √  | √  |              |
| 21  | * Rear suspension relay arm and connecting arm pivoting points | • Check operation.   |  | √  | √  | √  | √  |              |
|     |  | • Lubricate with molybdenum disulfide grease.  |  |    | √  |    | √  |              |
| 22  | * Carburetors  | • Check starter (choke) operation.<br>• Adjust engine idling speed and synchronization.                            | √  | √  | √  | √  | √  | √            |
| 23  | Engine oil   | • Change.  | √  | √  | √  | √  | √  | √            |
| 24  | Engine oil filter cartridge                                    | • Replace.   | √  |    | √  |    | √  |              |

# PERIODIC MAINTENANCE AND MINOR REPAIR

| NO. | ITEM | CHECK OR MAINTENANCE JOB   | ODOMETER READING ( $\times 1,000$ km) |    |    |    |    | Annual check |
|-----|------|--|---------------------------------------|----|----|----|----|--------------|
|     |      |  | 1                                     | 10 | 20 | 30 | 40 |              |
| 25  | *    | <b>Cooling system</b><br>• Check coolant level and vehicle for coolant leakage.<br>• Change. |                                       | √  | √  | √  | √  | √            |
|     |      |  | Every 3 years                         |    |    |    |    |              |
| 26  | *    | <b>Front and rear brake switches</b><br>• Check operation.                                   | √                                     | √  | √  | √  | √  | √            |
| 27  |      | <b>Moving parts and cables</b><br>• Lubricate.   |                                       | √  | √  | √  | √  | √            |
| 28  | *    | <b>Lights, signals and switches</b><br>• Check operation.<br>• Adjust headlight beam.        | √                                     | √  | √  | √  | √  | √            |

EAU03884

**NOTE:** \_\_\_\_\_

- The air filter needs more frequent service if you are riding in unusually wet or dusty areas.
- Hydraulic brake service
  - Regularly check and, if necessary, correct the brake fluid level.
  - Every two years replace the internal components of the brake master cylinders and calipers, and change the brake fluid.
  - Replace the brake hoses every four years and if cracked or damaged.

# PERIODIC MAINTENANCE AND MINOR REPAIR

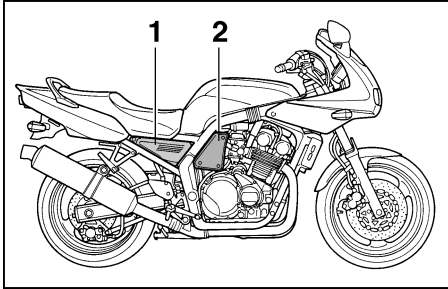

1. Panel A
2. Panel B

EAU01122

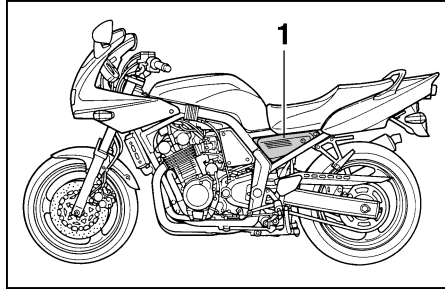

1. Panel C

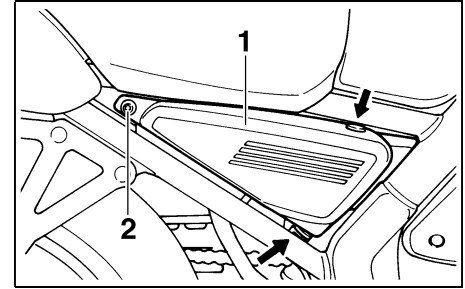

1. Panel A
2. Bolt

EAU00491

## Removing and installing panels

The panels shown above need to be removed to perform some of the maintenance jobs described in this chapter. Refer to this section each time a panel needs to be removed and installed.

### Panel A, C

To remove the panel

Remove the bolt, and then pull the panel off as shown.

To install the panel

Place the panel in the original position, and then install the bolt.

# PERIODIC MAINTENANCE AND MINOR REPAIR

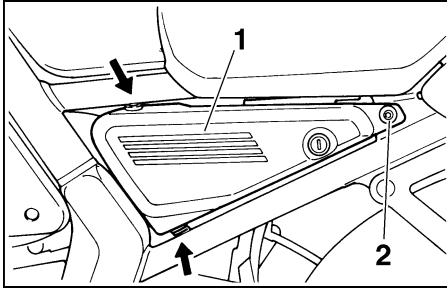

1. Panel C
2. Bolt

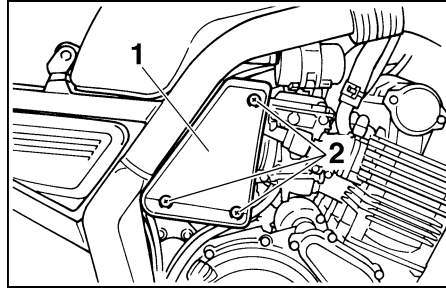

1. Panel B
2. Screw (× 3)

EAU01315

## **Panel B**

### To remove the panel

Remove the screws, and then take the panel off.

### To install the panel

Place the panel in the original position, and then install the screws.

# PERIODIC MAINTENANCE AND MINOR REPAIR

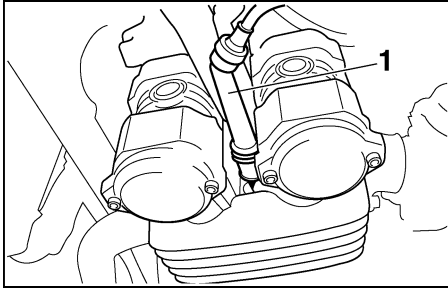

1. Spark plug cap

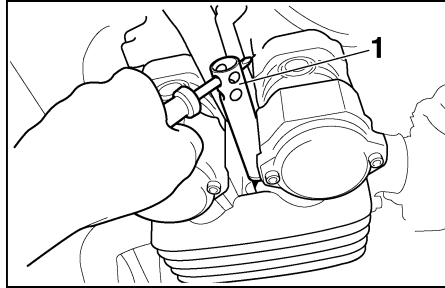

1. Spark plug wrench

EAU03329

## Checking the spark plugs

The spark plugs are important engine components, which are easy to check. Since heat and deposits will cause any spark plug to slowly erode, the spark plugs should be removed and checked in accordance with the periodic maintenance and lubrication chart. In addition, the condition of the spark plugs can reveal the condition of the engine.

### To remove a spark plug

1. Remove the spark plug cap.
2. Remove the spark plug as shown, with the spark plug wrench included in the owner's tool kit.

### To check the spark plugs

1. Check that the porcelain insulator around the center electrode on each spark plug is a medium-to-light tan (the ideal color when the motorcycle is ridden normally).
2. Check that all spark plugs installed in the engine have the same color.

### NOTE:

If any spark plug shows a distinctly different color, the engine could be defective. Do not attempt to diagnose such problems yourself. Instead, have a Yamaha dealer check the motorcycle.

3. Check each spark plug for electrode erosion and excessive carbon or other deposits, and replace it if necessary.

#### Specified spark plug:

Except for D, F  
CR8E, CR9E (NGK) or  
U24ESR-N, U27ESR-N  
(DENSO)

For D, F

CR7E, CR8E, CR9E (NGK) or  
U22ESR-N, U24ESR-N,  
U27ESR-N (DENSO)

# PERIODIC MAINTENANCE AND MINOR REPAIR

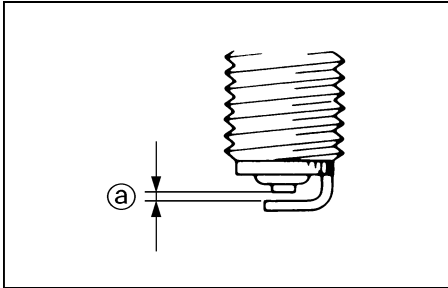

a. Spark plug gap

## To install a spark plug

1. Measure the spark plug gap with a wire thickness gauge and, if necessary, adjust the gap to specification.

Spark plug gap:  
0.7–0.8 mm

2. Clean the surface of the spark plug gasket and its mating surface, and then wipe off any grime from the spark plug threads.

3. Install the spark plug with the spark plug wrench, and then tighten it to the specified torque.

Tightening torque:  
Spark plug:  
12.5 Nm (1.25 m·kg)

**NOTE:** \_\_\_\_\_  
If a torque wrench is not available when installing a spark plug, a good estimate of the correct torque is 1/4–1/2 turn past finger tight. However, the spark plug should be tightened to the specified torque as soon as possible.

4. Install the spark plug cap.

# PERIODIC MAINTENANCE AND MINOR REPAIR

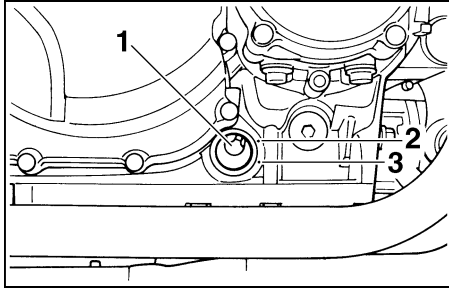

1. Engine oil level check window
2. Maximum level mark
3. Minimum level mark

EAU01717

## Engine oil and oil filter cartridge

The engine oil level should be checked before each ride. In addition, the oil must be changed and the oil filter cartridge replaced at the intervals specified in the periodic maintenance and lubrication chart.

### To check the engine oil level

1. Place the motorcycle on the centerstand.

#### NOTE:

Make sure that the motorcycle is positioned straight up when checking the oil level. A slight tilt to the side can result in a false reading.

2. Start the engine, warm it up for several minutes, and then turn it off.
3. Wait a few minutes until the oil settles, and then check the oil level through the check window located at the bottom-right side of the crankcase.

#### NOTE:

The engine oil should be between the minimum and maximum level marks.

4. If the engine oil is below the minimum level mark, add sufficient oil of the recommended type to raise it to the correct level.

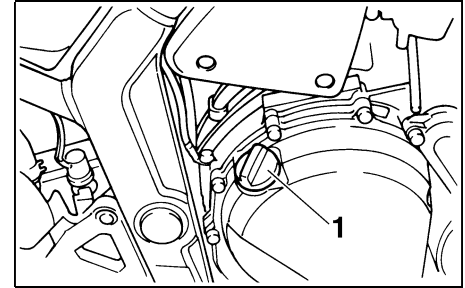

1. Engine oil filler cap

### To change the engine oil (with or without oil filter cartridge replacement)

1. Start the engine, warm it up for several minutes, and then turn it off.
2. Place an oil pan under the engine to collect the used oil.



# PERIODIC MAINTENANCE AND MINOR REPAIR

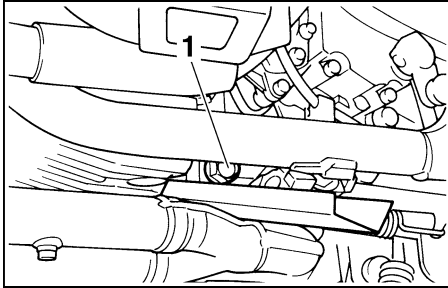

1. Engine oil drain bolt

3. Remove the engine oil filler cap and drain bolt to drain the oil from the crankcase.

**NOTE:** \_\_\_\_\_

- When draining the engine oil, use a funnel or similar device to keep the oil away from the exhaust pipe.
- Skip steps 4–6 if the oil filter cartridge is not being replaced.

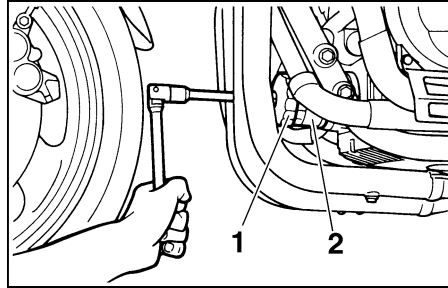

1. Oil filter wrench  
2. Oil filter cartridge

4. Remove the oil filter cartridge with an oil filter wrench.

**NOTE:** \_\_\_\_\_

An oil filter wrench is available at a Yamaha dealer.

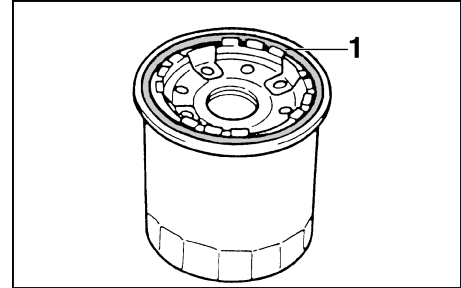

1. O-ring

5. Apply a thin coat of engine oil to the O-ring of the new oil filter cartridge.

**NOTE:** \_\_\_\_\_

Make sure that the O-ring is properly seated.

# PERIODIC MAINTENANCE AND MINOR REPAIR

EC000072

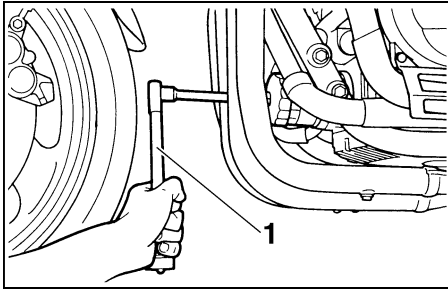

1. Torque wrench

6. Install the new oil filter cartridge, and then tighten it to the specified torque with a torque wrench.

Tightening torque:  
Oil filter cartridge:  
17 Nm (1.7 m·kg)

7. Install the engine oil drain bolt, and then tighten it to the specified torque.

Tightening torque:  
Engine oil drain bolt:  
43 Nm (4.3 m·kg)

8. Add the specified amount of the recommended engine oil, and then install and tighten the oil filler cap.

Recommended engine oil:

See page 8-1.

Oil quantity:

Without oil filter cartridge  
replacement:

2.5 L

With oil filter cartridge  
replacement:

2.7 L

Total amount (dry engine):

3.5 L

## CAUTION:

- In order to prevent clutch slippage (since the engine oil also lubricates the clutch), do not mix any chemical additives with the oil or use oils of a higher grade than “CD”. In addition, do not use oils labeled “ENERGY CONSERVING II” or higher.
- Make sure that no foreign material enters the crankcase.

9. Start the engine, and then let it idle for several minutes while checking it for oil leakage. If oil is leaking, immediately turn the engine off and check for the cause.

## NOTE:

After the engine is started, the engine oil level warning light should go off if the oil level is sufficient.

# PERIODIC MAINTENANCE AND MINOR REPAIR

EC000067

## CAUTION:

If the oil level warning light flickers or remains on, immediately turn the engine off and have a Yamaha dealer check the vehicle.

10. Turn the engine off, and then check the oil level and correct it if necessary.

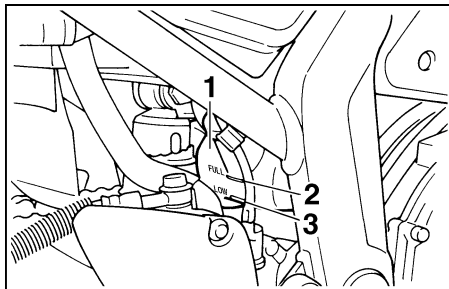

1. Coolant reservoir
2. Maximum level mark
3. Minimum level mark

EAU01718

## Coolant

### To check the coolant level

1. Place the motorcycle on a level surface and hold it in an upright position.

### NOTE:

- The coolant level must be checked on a cold engine since the level varies with engine temperature.
- Make sure that the motorcycle is positioned straight up when checking the coolant level. A slight tilt to the side can result in a false reading.

2. Remove panel A. (See page 6-5 for panel removal and installation procedures.)
3. Check the coolant level in the coolant reservoir.

### NOTE:

The coolant should be between the minimum and maximum level marks.

4. If the coolant is at or below the minimum level mark, open the reservoir cap, add coolant to the maximum level mark, and then close the reservoir cap.

Coolant reservoir capacity:  
0.61 L

# PERIODIC MAINTENANCE AND MINOR REPAIR

EC000080

## CAUTION:

- If coolant is not available, use distilled water or soft tap water instead. Do not use hard water or salt water since it is harmful to the engine.
- If water has been used instead of coolant, replace it with coolant as soon as possible, otherwise the engine may not be sufficiently cooled and the cooling system will not be protected against frost and corrosion.
- If water has been added to the coolant, have a Yamaha dealer check the antifreeze content of the coolant as soon as possible, otherwise the effectiveness of the coolant will be reduced.

EW000067

## WARNING

Never attempt to remove the radiator cap when the engine is hot.

5. Install the panel.

## NOTE:

The radiator fan is automatically switched on or off according to the coolant temperature in the radiator. If the engine overheats, see page 6-44 for further instructions.

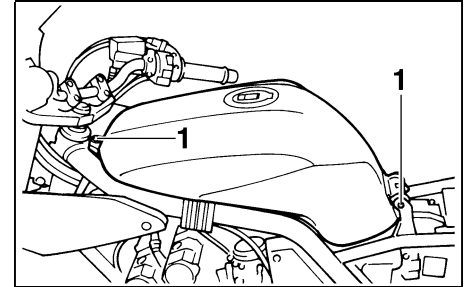

1. Bolt (× 2)

EAU03585

## To change the coolant

1. Place the motorcycle on the centerstand and let the engine cool if necessary.
2. Remove the seat. (See page 3-12 for seat removal and installation procedures.)
3. Remove the fuel tank bolts.

# PERIODIC MAINTENANCE AND MINOR REPAIR

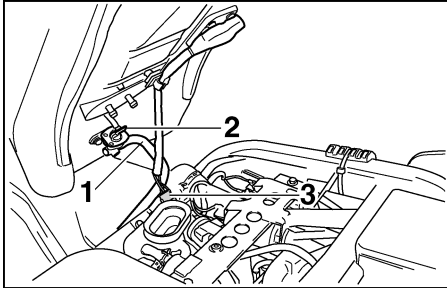

1. Hose
2. Fuel cock
3. Fuel level sensor coupler

4. Lift the fuel tank, and then turn the fuel cock lever to "OFF".
5. Disconnect the fuel level sensor coupler.
6. Pull the hose off the fuel tank and fuel cock, and then remove the tank.

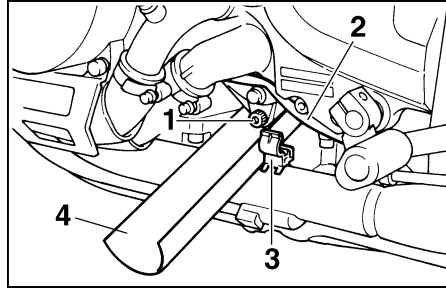

1. Water pump drain bolt
2. Sidestand switch lead
3. Lead holder
4. Funnel

7. Remove the sidestand switch lead from the holder.
8. Place a container under the engine to collect the used coolant.
9. Remove the water pump drain bolt to drain the water pump housing.
10. Make a guide using paper or cardboard or some other type of material, hold it under the coolant drain hole, and then remove the radiator cap to drain the remaining coolant.

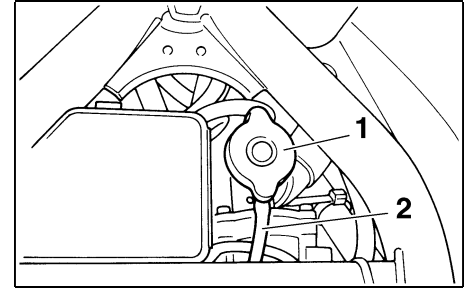

1. Radiator cap
2. Radiator overflow hose

EW000067

## **⚠ WARNING**

**Never attempt to remove the radiator cap when the engine is hot.**

11. Remove the coolant reservoir cap.
12. Disconnect the radiator overflow hose from the top of the radiator.

# PERIODIC MAINTENANCE AND MINOR REPAIR

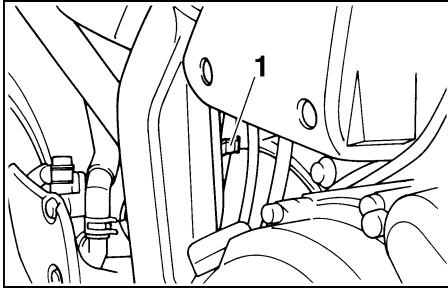

1. Hose holder

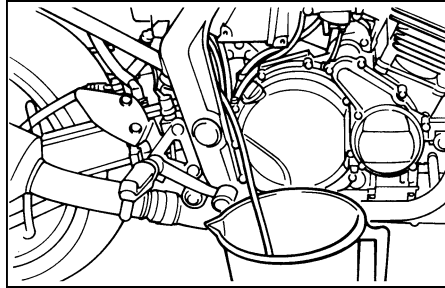

13. Pull the hose holder off the frame.

14. Pull the hose down and to the outside while making sure to keep the end up, and then tilt the hose downward into the container to drain the coolant reservoir.

**NOTE:** \_\_\_\_\_  
Note the original routing of the radiator overflow hose to ensure proper installation later on.

15. After the coolant is completely drained, thoroughly flush the cooling system with clean tap water.

16. Install the coolant drain bolt, and then tighten it to the specified torque.

**NOTE:** \_\_\_\_\_  
Check the washer for damage and replace it if necessary.

Tightening torque:  
Coolant drain bolt:  
10 Nm (1,0 m·kg)

17. Connect the radiator overflow hose and make sure that it is properly routed.

18. Pour the recommended coolant into the radiator until it is full.

Recommended antifreeze:  
High-quality ethylene glycol  
antifreeze containing corrosion  
inhibitors for aluminum engines  
Antifreeze/water mixture ratio:  
1:1

Coolant quantity:  
Total amount:  
1,95 L  
Coolant reservoir capacity:  
0,61 L

# PERIODIC MAINTENANCE AND MINOR REPAIR

EC000080

EW000072

## CAUTION:

- If coolant is not available, use distilled water or soft tap water instead. Do not use hard water or salt water since it is harmful to the engine.
- If water has been used instead of coolant, replace it with coolant as soon as possible, otherwise the engine may not be sufficiently cooled and the cooling system will not be protected against frost and corrosion.
- If water has been added to the coolant, have a Yamaha dealer check the antifreeze content of the coolant as soon as possible, otherwise the effectiveness of the coolant will be reduced.

19. Connect the fuel level sensor coupler, connect the fuel hose to the fuel tank and fuel cock, turn the fuel cock lever to "ON", and then place the fuel tank in the original position.

## ! WARNING

- Before installing the fuel tank, make sure that the fuel hoses are not damaged. If any fuel hose is damaged, do not start the engine but have a Yamaha dealer replace the hose, otherwise fuel may leak.
- Make sure that the fuel hoses are properly connected and routed, and not pinched.

20. Start the engine, let it idle for several minutes, turn it off, and then slightly lift the fuel tank to check the coolant level in the radiator. If necessary, add coolant until it reaches the top of the radiator.
21. Pour the recommended coolant into the reservoir to the maximum level mark.

22. Install the radiator cap and reservoir cap, start the engine, and then check the vehicle for coolant leakage. If coolant is leaking, have a Yamaha dealer check the cooling system.
23. Install the fuel tank bolts.
24. Pull the hoses down as shown.
25. Install the seat.

# PERIODIC MAINTENANCE AND MINOR REPAIR

EAU03559

## Air filter

The air filter element should be cleaned at the specified intervals. It should be cleaned more frequently if you are riding in unusually wet or dusty areas.

1. Remove the seat. (See page 3-12 for seat removal and installation procedures.)
2. Remove the fuel tank. (Refer to steps 2–6 of the “To change the coolant” section on page 6-13 for the fuel tank removal procedure.)

EW000071

### **⚠ WARNING**

- Make sure that the fuel tank is well supported.
- Do not tilt or pull the fuel tank too much, otherwise the fuel hoses may come loose, which could cause fuel leakage.

3. Remove panels A, B and C. (See page 6-5 and 6-6 for panel removal and installation procedures.)

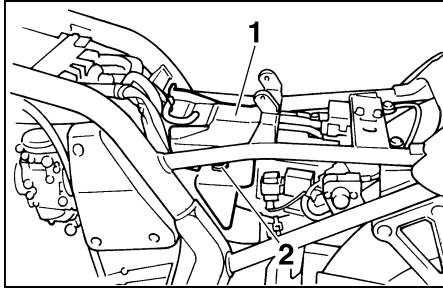

1. Rubber cover
2. Cover holder

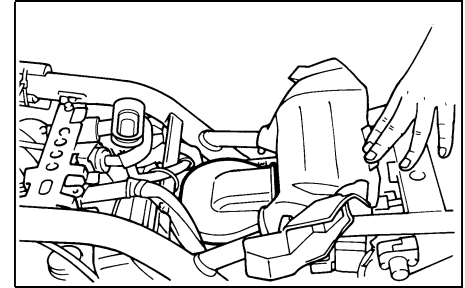

4. Remove the rubber cover from its holders by pushing it downward. Then pull it upward and back as shown, away from the air filter case.



# PERIODIC MAINTENANCE AND MINOR REPAIR

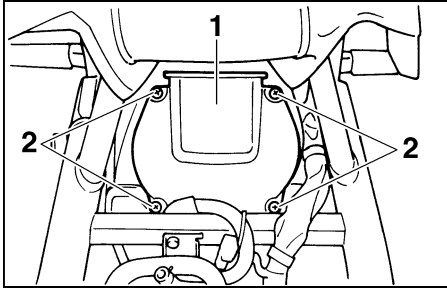

1. Air filter case cover
2. Screw (× 4)

5. Remove the screws holding the air filter case cover.

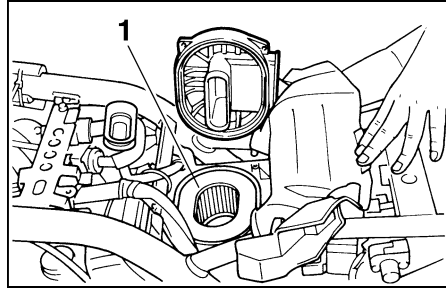

1. Air filter element

6. Pull out the air filter element.

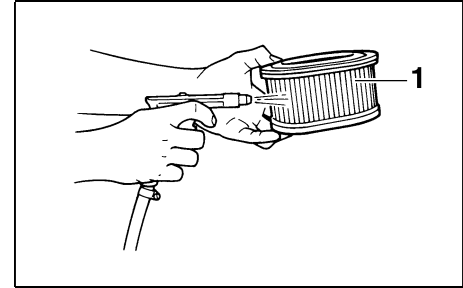

1. Air filter element

7. Tap the air filter element lightly to remove most of the dust and dirt. Blow out the remaining dirt with compressed air from the mesh side of the air filter element. If it is damaged, replace it.

8. Install by reversing the removal procedure.

EC000085

## CAUTION:

- Make sure the air filter is properly seated in the filter case.
- The engine should never be run without the air filter installed. Excessive piston and/or cylinder wear may result.

# PERIODIC MAINTENANCE AND MINOR REPAIR

---

---

EW000072

## **WARNING**

- Before installing the fuel tank, make sure that the fuel hoses are not damaged. If any fuel hose is damaged, do not start the engine but have a Yamaha dealer replace the hose, otherwise fuel may leak.
  - Make sure that the fuel hoses are properly connected and routed, and not pinched.
- 

EAU00630

## Adjusting the carburetors

The carburetors are important parts of the engine and require very sophisticated adjustment. Therefore, most carburetor adjustments should be left to a Yamaha dealer, who has the necessary professional knowledge and experience. The adjustment described in the following section, however, may be serviced by the owner as part of routine maintenance.

EC000095

## **CAUTION:**

**The carburetors have been set and extensively tested at the Yamaha factory. Changing these settings without sufficient technical knowledge may result in poor performance of or damage to the engine.**

---

EAU00632

## Adjusting the engine idling speed

The engine idling speed must be checked and, if necessary, adjusted as follows at the intervals specified in the periodic maintenance and lubrication chart.

1. Start the engine and warm it up for several minutes at 1,000–2,000 r/min while occasionally revving it to 4,000–5,000 r/min.

## **NOTE:**

The engine is warm when it quickly responds to the throttle.

---

# PERIODIC MAINTENANCE AND MINOR REPAIR

EAU00637

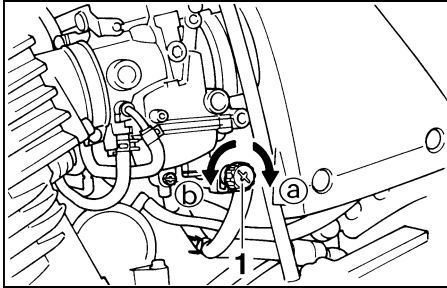

1. Throttle stop screw

2. Check the engine idling speed and, if necessary, adjust it to specification by turning the throttle stop screw. To increase the engine idling speed, turn the screw in direction (a). To decrease the engine idling speed, turn the screw in direction (b).

Engine idling speed:  
1,150–1,250 r/min

## NOTE:

If the specified idling speed cannot be obtained as described above, have a Yamaha dealer make the adjustment.

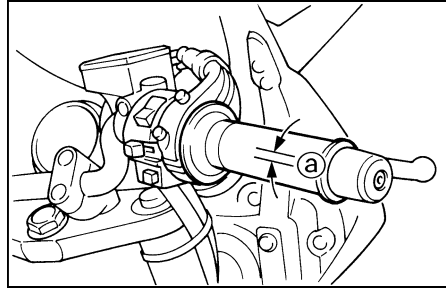

a. Throttle cable free play

## Adjusting the valve clearance

The valve clearance changes with use, resulting in improper air-fuel mixture and/or engine noise. To prevent this from occurring, the valve clearance must be adjusted by a Yamaha dealer at the intervals specified in the periodic maintenance and lubrication chart.

EAU00635

## Adjusting the throttle cable free play

The throttle cable free play should measure 3–5 mm at the throttle grip. Periodically check the throttle cable free play and, if necessary, have a Yamaha dealer adjust it.

# PERIODIC MAINTENANCE AND MINOR REPAIR

## Tires

EAU00658

To maximize the performance, durability, and safe operation of your motorcycle, note the following points regarding the specified tires.

### Tire air pressure

The tire air pressure should be checked and, if necessary, adjusted before each ride.

EWA00082

#### **WARNING**

- The tire air pressure must be checked and adjusted on cold tires (i.e., when the temperature of the tires equals the ambient temperature).
- The tire air pressure must be adjusted in accordance with the riding speed and with the total weight of rider, passenger, cargo, and accessories approved for this model.

| Tire air pressure<br>(measured on cold tires) |  |  |
|---|--|--|
| Load*   | Front  | Rear   |
| Up to 90 kg                                   | 225 kPa<br>2.25 kg/cm <sup>2</sup><br>2.25 bar | 250 kPa<br>2.50 kg/cm <sup>2</sup><br>2.50 bar |
| 90 kg—maximum                                 | 225 kPa<br>2.25 kg/cm <sup>2</sup><br>2.25 bar | 290 kPa<br>2.90 kg/cm <sup>2</sup><br>2.90 bar |
| High-speed riding                             | 225 kPa<br>2.25 kg/cm <sup>2</sup><br>2.25 bar | 290 kPa<br>2.90 kg/cm <sup>2</sup><br>2.90 bar |

|               |        |
|---------------|--------|
| Maximum load* | 187 kg |
|---------------|--------|

\* Total weight of rider, passenger, cargo and accessories

EWA00012

#### **WARNING**

Because loading has an enormous impact on the handling, braking, performance and safety characteristics of your motorcycle, you should keep the following precautions in mind.

- **NEVER OVERLOAD THE MOTORCYCLE!** Operation of an overloaded motorcycle may result in tire damage, loss of control, or severe injury. Make sure that the total weight of rider, passenger, cargo, and accessories does not exceed the specified maximum load for the vehicle.
- Do not carry along loosely packed items, which can shift during a ride.
- Securely pack the heaviest items close to the center of the motorcycle and distribute the weight evenly on both sides.

# PERIODIC MAINTENANCE AND MINOR REPAIR

EW000079

- Adjust the suspension and tire air pressure with regard to the load.
- Check the tire condition and air pressure before each ride.

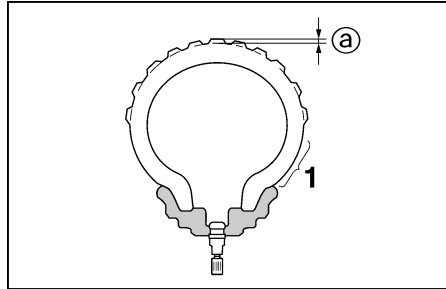

- 1. Side wall
- a. Tire tread depth

## Tire inspection

The tires must be checked before each ride. If the center tread depth reaches the specified limit, if the tire has a nail or glass fragments in it, or if the side-wall is cracked, have a Yamaha dealer replace the tire immediately.

|  |        |
|--|--------|
| Minimum tire tread depth<br>(front and rear) | 1.6 mm |
|--|--------|

## NOTE:

The tire tread depth limits may differ from country to country. Always comply with the local regulations.

## WARNING

- Have a Yamaha dealer replace excessively worn tires. Besides being illegal, operating the motorcycle with excessively worn tires decreases riding stability and can lead to loss of control.
- The replacement of all wheel- and brake-related parts, including the tires, should be left to a Yamaha dealer, who has the necessary professional knowledge and experience.

# PERIODIC MAINTENANCE AND MINOR REPAIR

EW000080

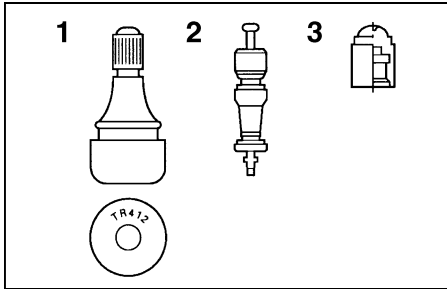

1. Tire air valve
2. Valve core
3. Valve cap with seal

## Tire information

This motorcycle is equipped with cast wheels and tubeless tires with valves.

### **⚠ WARNING**

- The front and rear tires should be of the same make and design, otherwise the handling characteristics of the motorcycle cannot be guaranteed.
- After extensive tests, only the tires listed below have been approved for this model by Yamaha Motor Co., Ltd.
- Always make sure that the valve caps are securely installed to prevent air pressure leakage.
- Use only the tire valves and valve cores listed below to avoid tire deflation during a high-speed ride.

## FRONT

| Manufacturer | Size              | Type   |
|--------------|-------------------|--------|
| Bridgestone  | 110/70 ZR17 (54W) | BT-57F |
| Dunlop       | 110/70 ZR17 (54W) | D207F  |

## REAR

| Manufacturer | Size              | Type   |
|--------------|-------------------|--------|
| Bridgestone  | 160/60 ZR17 (69W) | BT-57R |
| Dunlop       | 160/60 ZR17 (69W) | D207J  |

## FRONT & REAR

|                |                   |
|----------------|-------------------|
| Tire air valve | TR412             |
| Valve core     | #9000A (original) |

EAU00684

EAU00687

## **⚠ WARNING**

This motorcycle is fitted with super-high-speed tires. Note the following points in order to make the most efficient use of these tires.

- Use only the specified replacement tires. Other tires may run the danger of bursting at super high speeds.
- Brand-new tires can have a relatively poor grip on certain road surfaces until they have been “broken in”. Therefore, it is advisable before doing any high-speed riding to ride conservatively for approximately 100 km after installing a new tire.
- The tires must be warmed up before a high-speed run.
- Always adjust the tire air pressure according to the operating conditions.

## Wheels

To maximize the performance, durability, and safe operation of your motorcycle, note the following points regarding the specified wheels.

- The wheel rims should be checked for cracks, bends or warpage before each ride. If any damage is found, have a Yamaha dealer replace the wheel. Do not attempt even the smallest repair to the wheel. A deformed or cracked wheel must be replaced.
- The wheel should be balanced whenever either the tire or wheel has been changed or replaced. An unbalanced wheel can result in poor performance, adverse handling characteristics, and a shortened tire life.
- Ride at moderate speeds after changing a tire since the tire surface must first be “broken in” for it to develop its optimal characteristics.

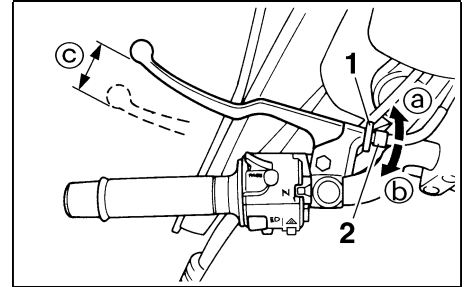

1. Clutch lever free play locknut
2. Clutch lever free play adjusting bolt
- c. Clutch lever free play

EAU00692

## Adjusting the clutch lever free play

The clutch lever free play should measure 10–15 mm as shown. Periodically check the clutch lever free play and, if necessary, adjust it as follows.

1. Loosen the locknut at the clutch lever.
2. To increase the clutch lever free play, turn the adjusting bolt in direction ①. To decrease the clutch lever free play, turn the adjusting bolt in direction ②.
3. Tighten the locknut.

# PERIODIC MAINTENANCE AND MINOR REPAIR

## NOTE:

If the specified free play cannot be obtained as described above or if the clutch does not operate correctly, have a Yamaha dealer check the internal clutch mechanism.

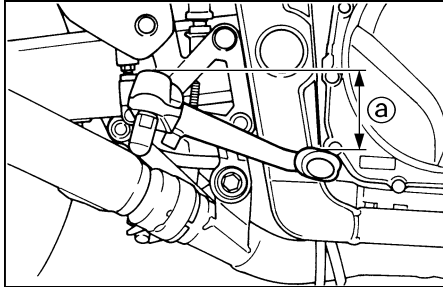

a. Distance between brake pedal and footrest

EAU00712

## Adjusting the brake pedal position

The top of the brake pedal should be positioned approximately 36.6 mm below the top of the footrest as shown. Periodically check the brake pedal position and, if necessary, have a Yamaha dealer adjust it.

EW000109

## **!** WARNING

A soft or spongy feeling in the brake pedal can indicate the presence of air in the hydraulic system. If there is air in the hydraulic system, have a Yamaha dealer bleed the system before operating the motorcycle. Air in the hydraulic system will diminish the braking performance, which may result in loss of control and an accident.



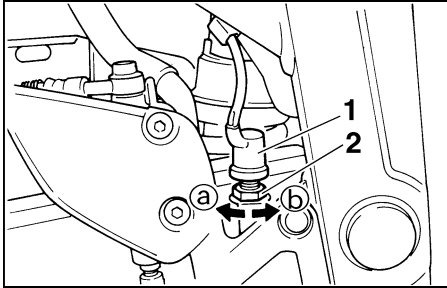

1. Rear brake light switch
2. Brake light switch adjusting nut

EAU00713

## Adjusting the rear brake light switch

The rear brake light switch, which is activated by the brake pedal, is properly adjusted when the brake light comes on just before braking takes effect. If necessary, adjust the brake light switch as follows.

Turn the adjusting nut while holding the rear brake light switch in place. To make the brake light come on earlier, turn the adjusting nut in direction Ⓐ. To make the brake light come on later, turn the adjusting nut in direction Ⓑ.

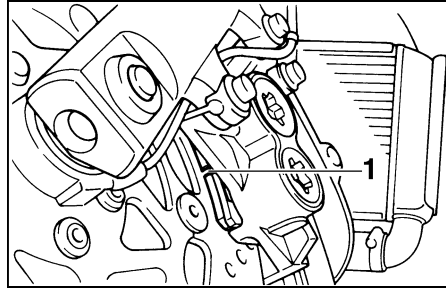

1. Brake pad wear indicator groove

EAU01314

## Checking the front and rear brake pads

The front and rear brake pads must be checked for wear at the intervals specified in the periodic maintenance and lubrication chart. Each brake pad is provided with a wear indicator groove, which allows you to check the brake pad wear without having to disassemble the brake. To check the brake pad wear, check the wear indicator grooves. If a brake pad has worn to the point that the wear indicator groove has almost disappeared, have a Yamaha dealer replace the brake pads as a set.

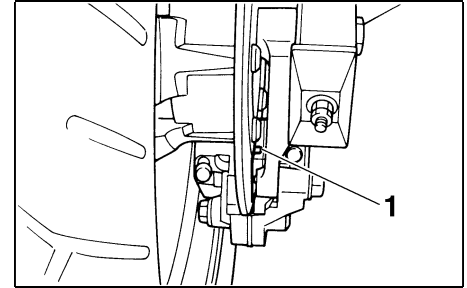

1. Brake pad wear indicator groove

# PERIODIC MAINTENANCE AND MINOR REPAIR

Front brake

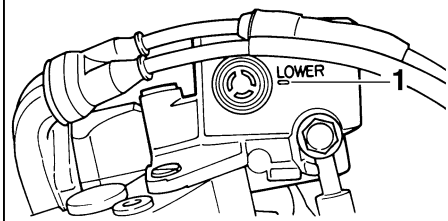

1. Minimum level mark

EAU03196

## Checking the brake fluid level

Insufficient brake fluid may allow air to enter the brake system, possibly causing it to become ineffective.

Before riding, check that the brake fluid is above the minimum level mark and replenish if necessary. A low brake fluid level may indicate worn brake pads and/or brake system leakage. If the brake level is low, be sure to check the brake pads for wear and the brake system for leakage.

Rear brake

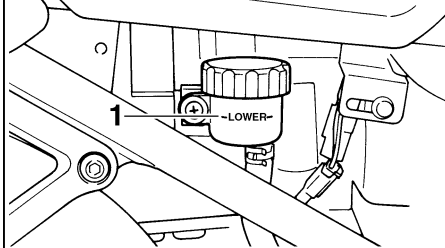

1. Minimum level mark

Observe these precautions:

- When checking the fluid level, make sure that the top of the master cylinder or brake fluid reservoir is level.
- Use only the recommended quality brake fluid, otherwise the rubber seals may deteriorate, causing leakage and poor braking performance.

Recommended brake fluid: DOT 4

- Refill with the same type of brake fluid. Mixing fluids may result in a harmful chemical reaction and lead to poor braking performance.

- Be careful that water does not enter the master cylinder when refilling. Water will significantly lower the boiling point of the fluid and may result in vapor lock.
- Brake fluid may deteriorate painted surfaces or plastic parts. Always clean up spilled fluid immediately.
- As the brake pads wear, it is normal for the brake fluid level to gradually go down. However, if the brake fluid level goes down suddenly, have a Yamaha dealer check the cause.

## Changing the brake fluid

EAU03238

Have a Yamaha dealer change the brake fluid at the intervals specified in the periodic maintenance and lubrication chart. In addition, have the oil seals of the brake master cylinder and caliper as well as the brake hose replaced at the intervals listed below or whenever they are damaged or leaking.

- Oil seals: Replace every two years.
- Brake hose: Replace every four years.

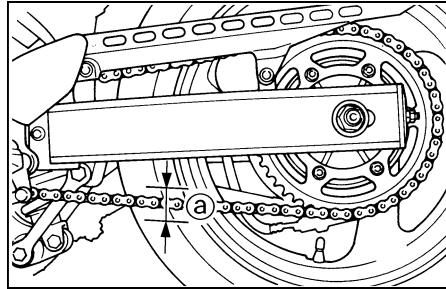

a. Drive chain slack

Drive chain slack:  
30–45 mm

5. If the drive chain slack is incorrect, adjust it as follows.

## Drive chain slack

EAU00745

The drive chain slack should be checked before each ride and adjusted if necessary.

### To check the drive chain slack

1. Place the motorcycle on the centerstand.
2. Shift the transmission into the neutral position.
3. Spin the rear wheel several times to locate the tightest portion of the drive chain.
4. Measure the drive chain slack as shown.

# PERIODIC MAINTENANCE AND MINOR REPAIR

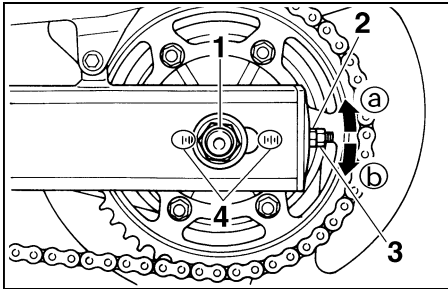

1. Axle nut
2. Drive chain slack adjusting nut
3. Chain puller locknut
4. Alignment marks

EAU00762

## To adjust the drive chain slack

1. Loosen the axle nut, then the chain puller locknut at each end of the swingarm.
2. To tighten the drive chain, turn the adjusting nut at each end of the swingarm in direction ①. To loosen the drive chain, turn the adjusting nut at each end of the swingarm in direction ②, and then push the rear wheel forward.

**NOTE:** Using the alignment marks on each side of the swingarm, make sure that both adjusting nuts are in the same position for proper wheel alignment.

EC000096

**CAUTION:** Improper drive chain slack will overload the engine as well as other vital parts of the motorcycle and can lead to chain slippage or breakage. To prevent this from occurring, keep the drive chain slack within the specified limits.

3. Tighten the locknuts, and then tighten the axle nut to the specified torque.

Tightening torque:

Axle nut:

117 Nm (11.7 m·kg)

EAU03006

## Lubricating the drive chain

The drive chain must be cleaned and lubricated at the intervals specified in the periodic maintenance and lubrication chart, otherwise it will quickly wear out, especially when riding in dusty or wet areas. Service the drive chain as follows.

EC000097

**CAUTION:** The drive chain must be lubricated after washing the motorcycle or riding in the rain.

1. Clean the drive chain with kerosene and a small soft brush.

ECA00053

**CAUTION:** To prevent damaging the O-rings, do not clean the drive chain with steam cleaners, high-pressure washers or inappropriate solvents.

# PERIODIC MAINTENANCE AND MINOR REPAIR

2. Wipe the drive chain dry.
3. Thoroughly lubricate the drive chain with a special O-ring chain lubricant.

ECA00052

## **CAUTION:**

**Do not use engine oil or any other lubricants for the drive chain, as they may contain substances that could damage the O-rings.**

## **Checking and lubricating the cables**

EAU02962

The operation of all control cables and the condition of the cables should be checked before each ride, and the cables and cable ends should be lubricated if necessary. If a cable is damaged or does not move smoothly, have a Yamaha dealer check or replace it.

Recommended lubricant:  
Engine oil

EW000112

## **⚠ WARNING**

**Damage to the outer sheath may interfere with proper cable operation and will cause the inner cable to rust. Replace a damaged cable as soon as possible to prevent unsafe conditions.**

# PERIODIC MAINTENANCE AND MINOR REPAIR

EAU03209

## Checking and lubricating the throttle grip and cable

The operation of the throttle grip and the condition of the throttle cable should be checked before each ride, and the cable should be lubricated or replaced if necessary.

### NOTE:

Since the throttle grip must be removed to access the throttle cable end, the throttle grip and the cable should always be lubricated at the same time.

1. Remove the throttle grip by removing the screws.
2. Disconnect the throttle cable, hold it up, and then apply several drops of oil to the cable end, allowing it to trickle into the sheath.
3. Connect the throttle cable, and then grease the inside of the throttle grip housing.
4. Grease the metal-to-metal contact surface of the throttle grip, and then install the grip by installing the screws.

Recommended lubricant:

Throttle cable:

Engine oil

Throttle grip housing and grip:

Lithium-soap-based grease  
(all-purpose grease)

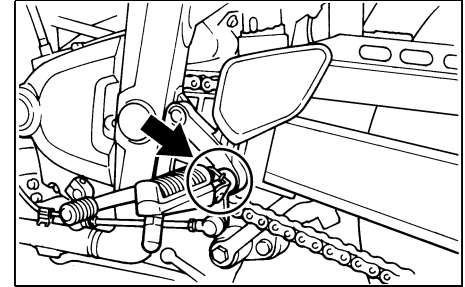

EAU03370

## Checking and lubricating the brake and shift pedals

The operation of the brake and shift pedals should be checked before each ride, and the pedal pivots should be lubricated if necessary.

Recommended lubricant:

Lithium-soap-based grease  
(all-purpose grease)

# PERIODIC MAINTENANCE AND MINOR REPAIR

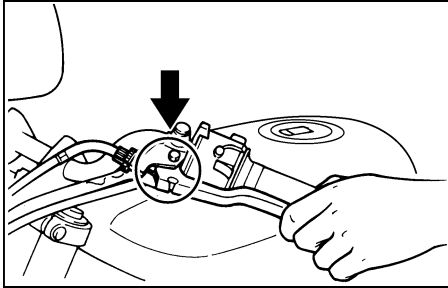

EAU03164

## Checking and lubricating the brake and clutch levers

The operation of the brake and clutch levers should be checked before each ride, and the lever pivots should be lubricated if necessary.

Recommended lubricant:  
Lithium-soap-based grease  
(all-purpose grease)

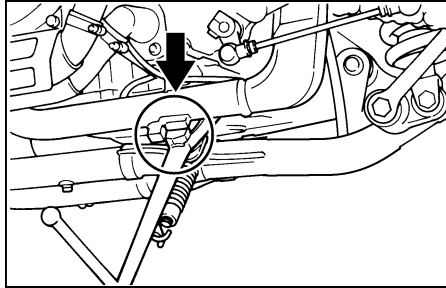

EAU03371

## Checking and lubricating the centerstand and sidestand

The operation of the centerstand and sidestand should be checked before each ride, and the pivots and metal-to-metal contact surfaces should be lubricated if necessary.

EW000114

### **⚠ WARNING**

**If the centerstand or sidestand does not move up and down smoothly, have a Yamaha dealer check or repair it.**

Recommended lubricant:  
Lithium-soap-based grease  
(all-purpose grease)

# PERIODIC MAINTENANCE AND MINOR REPAIR

## Lubricating the rear suspension

EAU00790

The pivoting points of the rear suspension must be lubricated at the intervals specified in the periodic maintenance and lubrication chart.

Recommended lubricant:  
Molybdenum disulfide grease

## Checking the front fork

EAU02939

The condition and operation of the front fork must be checked as follows at the intervals specified in the periodic maintenance and lubrication chart.

### To check the condition

EW000115



**Securely support the motorcycle so that there is no danger of it falling over.**

Check the inner tubes for scratches, damage and excessive oil leakage.

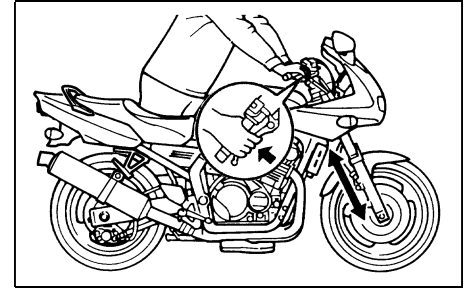

### To check the operation

1. Place the motorcycle on a level surface and hold it in an upright position.
2. While applying the front brake, push down hard on the handlebars several times to check if the front fork compresses and rebounds smoothly.

EC000098

### **CAUTION:**

**If any damage is found or the front fork does not operate smoothly, have a Yamaha dealer check or repair it.**



# PERIODIC MAINTENANCE AND MINOR REPAIR

## Checking the steering

EAU00794

Worn or loose steering bearings may cause danger. Therefore, the operation of the steering must be checked as follows at the intervals specified in the periodic maintenance and lubrication chart.

1. Place a stand under the engine to raise the front wheel off the ground.

EW000115

### **WARNING**

**Securely support the motorcycle so that there is no danger of it falling over.**

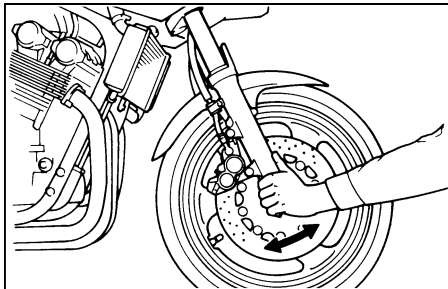

2. Hold the lower ends of the front fork legs and try to move them forward and backward. If any free play can be felt, have a Yamaha dealer check or repair the steering.

## Checking the wheel bearings

EAU01144

The front and rear wheel bearings must be checked at the intervals specified in the periodic maintenance and lubrication chart. If there is play in the wheel hub or if the wheel does not turn smoothly, have a Yamaha dealer check the wheel bearings.

# PERIODIC MAINTENANCE AND MINOR REPAIR

---

## Battery

EAU01271

This motorcycle is equipped with a sealed-type (MF) battery, which does not require any maintenance. There is no need to check the electrolyte or to add distilled water.

### To charge the battery

Have a Yamaha dealer charge the battery as soon as possible if it seems to have discharged. Keep in mind that the battery tends to discharge more quickly if the motorcycle is equipped with optional electrical accessories.

EW000116

### WARNING

- **Electrolyte is poisonous and dangerous since it contains sulfuric acid, which causes severe burns. Avoid any contact with skin, eyes or clothing and always shield your eyes when working near batteries. In case of contact, administer the following FIRST AID.**

- **EXTERNAL: Flush with plenty of water.**
  - **INTERNAL: Drink large quantities of water or milk and immediately call a physician.**
  - **EYES: Flush with water for 15 minutes and seek prompt medical attention.**
  - **Batteries produce explosive hydrogen gas. Therefore, keep sparks, flames, cigarettes, etc., away from the battery and provide sufficient ventilation when charging it in an enclosed space.**
  - **KEEP THIS AND ALL BATTERIES OUT OF THE REACH OF CHILDREN.**
- 

### To store the battery

1. If the motorcycle will not be used for more than one month, remove the battery, fully charge it, and then place it in a cool, dry place.
2. If the battery will be stored for more than two months, check it at least once a month and fully charge it if necessary.
3. Fully charge the battery before installation.

EC000102

### CAUTION:

- **Always keep the battery charged. Storing a discharged battery can cause permanent battery damage.**
  - **To charge a sealed-type (MF) battery, a special (constant-voltage) battery charger is required. Using a conventional battery charger will damage the battery. If you do not have access to a sealed-type (MF) battery charger, have a Yamaha dealer charge your battery.**
-

# PERIODIC MAINTENANCE AND MINOR REPAIR

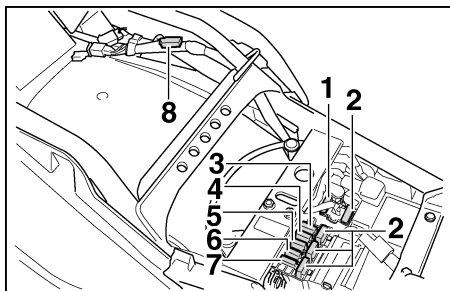

1. Main fuse
2. Spare fuse (× 4)
3. Ignition fuse
4. Signaling system fuse
5. Headlight fuse
6. Radiator fan fuse
7. Odometer fuse
8. Hazard fuse

EAU01720\*

## Replacing the fuses

The fuse boxes are located under the seat. (See page 3-12 for seat removal and installation procedures.)

If a fuse is blown, replace it as follows.

1. Turn the key to “OFF” and turn off the electrical circuit in question.
2. Remove the blown fuse, and then install a new fuse of the specified amperage.

|                        |      |
|------------------------|------|
| Specified fuses:       |      |
| Main fuse:             | 30 A |
| Headlight fuse:        | 20 A |
| Hazard fuse:           | 10 A |
| Ignition fuse:         | 20 A |
| Signaling system fuse: | 20 A |
| Odometer fuse:         | 5 A  |
| Radiator fan fuse:     | 10 A |

EC000103

### CAUTION:

**Do not use a fuse of a higher amperage rating than recommended to avoid causing extensive damage to the electrical system and possibly a fire.**

3. Turn the key to “ON” and turn on the electrical circuit in question to check if the device operates.
4. If the fuse immediately blows again, have a Yamaha dealer check the electrical system.

# PERIODIC MAINTENANCE AND MINOR REPAIR

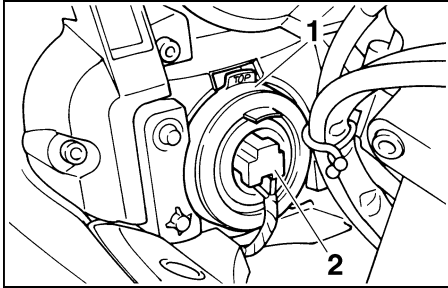

1. Headlight bulb cover
2. Headlight coupler

EAU00826

## Replacing the headlight bulb

This motorcycle is equipped with a quartz bulb headlight. If the headlight bulb burns out, replace it as follows.

1. Disconnect the headlight coupler, and then remove the headlight bulb cover.

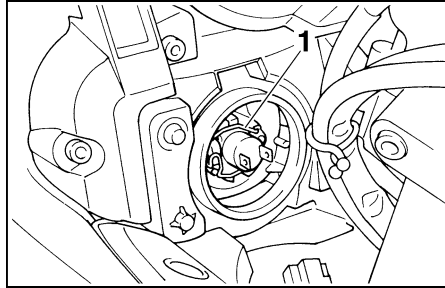

1. Headlight bulb holder
2. Unhook the headlight bulb holder, and then remove the defective bulb.

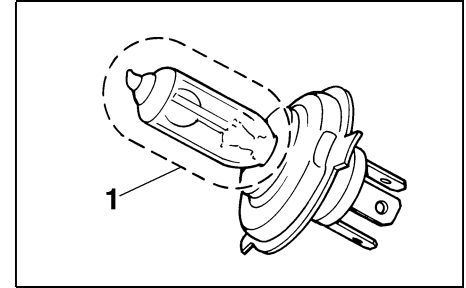

1. Do not touch this area.

EW000119

### **WARNING**

Headlight bulbs get very hot. Therefore, keep flammable products away from a lit headlight bulb, and do not touch the bulb until it has cooled down.

3. Place a new bulb into position, and then secure it with the bulb holder.

EC000104

## CAUTION:

Take care not to damage the following parts:

- **Headlight bulb**

Do not touch the glass part of the headlight bulb to keep it free from oil, otherwise the transparency of the glass, the luminosity of the bulb, and the bulb life will be adversely affected. Thoroughly clean off any dirt and fingerprints on the headlight bulb using a cloth moistened with alcohol or thinner.

- **Headlight lens**

- Do not affix any type of tinted film or stickers to the headlight lens.
- Do not use a headlight bulb of a wattage higher than specified.

4. Install the bulb cover, and then connect the coupler.
5. Have a Yamaha dealer adjust the headlight beam if necessary.

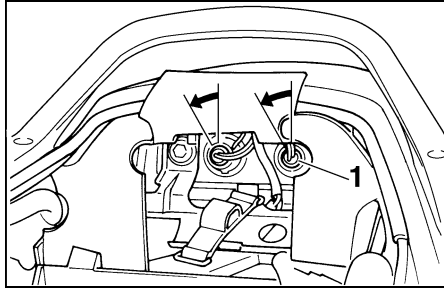

1. Socket

EAU00858

## Replacing the tail/brake light bulb

1. Remove the seat. (See page 3-12 for seat removal and installation procedures.)
2. Remove the owner's tool kit.
3. Remove the socket (together with the bulb) by turning it counter-clockwise.
4. Remove the defective bulb by pushing it in and turning it counter-clockwise.
5. Insert a new bulb into the socket, push it in, and then turn it clockwise until it stops.

6. Install the socket (together with the bulb) by turning it clockwise.
7. Install the owner's tool kit.
8. Install the seat.

# PERIODIC MAINTENANCE AND MINOR REPAIR

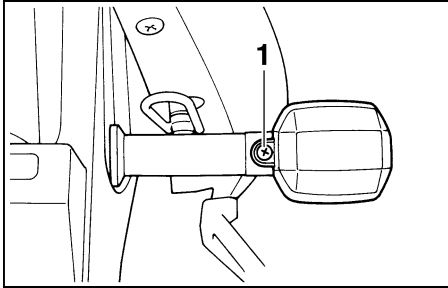

1. Screw

EAU01095

## Replacing a turn signal light bulb

1. Remove the turn signal light lens by removing the screw.
2. Remove the defective bulb by pushing it in and turning it counter-clockwise.
3. Insert a new bulb into the socket, push it in, and then turn it clockwise until it stops.
4. Install the lens by installing the screw.

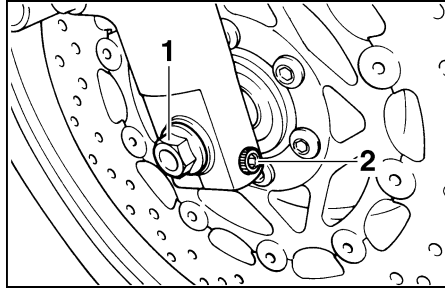

1. Wheel axle
2. Front wheel axle pinch bolt

EAU03560

## Front wheel

### To remove the front wheel

EW000122

#### **WARNING**

- It is advisable to have a Yamaha dealer service the wheel.
- Securely support the motorcycle so that there is no danger of it falling over.

1. Place the motorcycle on the centerstand.
2. Loosen the front wheel axle pinch bolt, then the wheel axle and the brake caliper bolts.

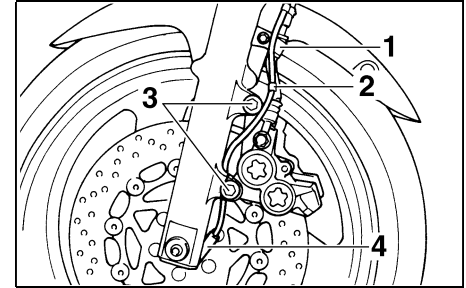

1. Brake hose holder
2. Plastic fastener
3. Caliper bolt (× 2)
4. Speed sensor

3. Remove the brake hose holders by removing the bolts.
4. Remove the brake calipers by removing the bolts.

ECA00047

#### **CAUTION:**

**Do not pull the brake lever after the brake caliper has been removed, otherwise the brake pads will be forced shut.**

# PERIODIC MAINTENANCE AND MINOR REPAIR

5. Remove the plastic fastener holding the speed sensor lead and the brake hose together.
6. While supporting the speed sensor, pull the wheel axle out, and then remove the wheel.

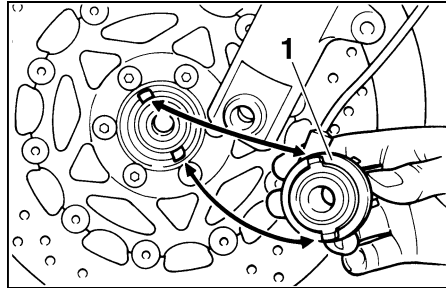

1. Speed sensor

EAU01309\*

## To install the front wheel

1. Lift the wheel up between the fork legs.
2. Install the speed sensor at the wheel hub.

### **NOTE:** \_\_\_\_\_

Make sure that the projections on the speed sensor rotor are aligned with the notches in the wheel hub and that the slot in the speed sensor fits over the retainer on the fork leg.

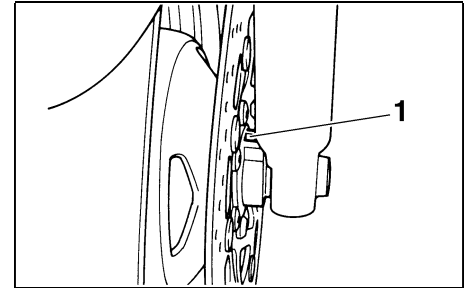

1. Speed sensor retainer

3. Insert the wheel axle.
4. Lower the front wheel so that it is on the ground.
5. Push down hard on the handlebar several times to check for proper fork operation.
6. Install the brake calipers by installing the bolts.

### **NOTE:** \_\_\_\_\_

Make sure that there is enough space between the brake pads before installing the brake calipers onto the brake discs.

7. Install the brake hose holders by installing the bolts.

# PERIODIC MAINTENANCE AND MINOR REPAIR

- Bind the speed sensor lead and the brake hose together with the plastic fastener.
- Tighten the wheel axle, front wheel axle pinch bolt and brake caliper bolts to the specified torques.

## Tightening torques:

Wheel axle:

67 Nm (6.7 m·kg)

Front wheel axle pinch bolt:

20 Nm (2.0 m·kg)

Brake caliper bolt:

40 Nm (4.0 m·kg)

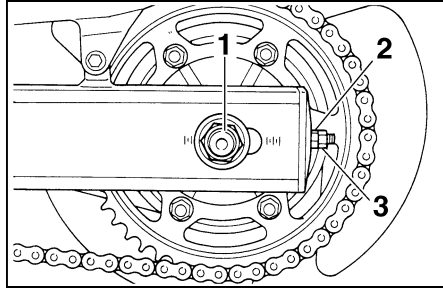

1. Axle nut
2. Drive chain slack adjusting nut
3. Locknut

EAU01318\*

## Rear wheel

### To remove the rear wheel

EW000122

#### WARNING

- It is advisable to have a Yamaha dealer service the wheel.
- Securely support the motorcycle so that there is no danger of it falling over.

1. Loosen the axle nut and the brake caliper bolts.

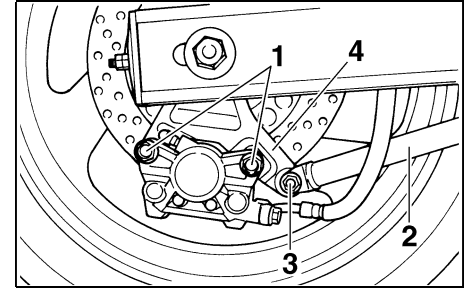

1. Brake caliper bolt (x 2)
2. Brake torque rod
3. Brake torque rod nut
4. Brake caliper bracket

2. Disconnect the brake torque rod from the brake caliper bracket by removing the nut and the bolt.
3. Place the motorcycle on the centerstand.
4. Remove the axle nut and the brake caliper by removing the bolts.
5. Loosen the locknut and drive chain adjusting nut on each side of the swingarm.
6. Push the wheel forward, and then remove the drive chain from the rear sprocket.



# PERIODIC MAINTENANCE AND MINOR REPAIR

## NOTE:

The drive chain does not need to be disassembled in order to remove and install the rear wheel.

7. While supporting the brake caliper bracket, pull the wheel axle out.
8. Remove the wheel.

ECA00048

## CAUTION:

**Do not apply the brake after the wheel has been removed together with the brake disc, otherwise the brake pads will be forced shut.**

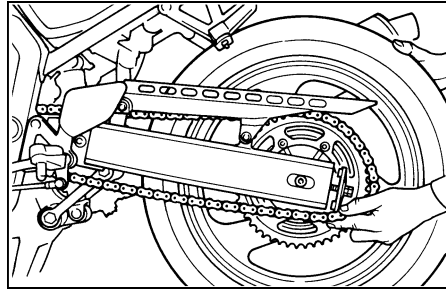

EAU01317

## To install the rear wheel

1. Insert the wheel axle through the brake caliper bracket and wheel from the left-hand side.
2. Install the drive chain onto the rear sprocket, and then adjust the drive chain slack. (See page 6-28 for drive chain slack adjustment procedures.)
3. Connect the brake torque rod to the brake caliper bracket by installing the bolt and the nut.
4. Install the brake caliper by installing the bolts.

## NOTE:

Make sure that there is enough space between the brake pads before installing the brake caliper onto the brake disc.

5. Take the motorcycle off the centerstand so that the rear wheel is on the ground.
6. Tighten the axle nut, brake caliper bolts and brake torque rod nut to the specified torques.

## Tightening torques:

Axle nut:

117 Nm (11.7 m·kg)

Brake caliper bolt:

40 Nm (4.0 m·kg)

Brake torque rod nut:

23 Nm (2.3 m·kg)

# PERIODIC MAINTENANCE AND MINOR REPAIR

---

EAU03087

## Troubleshooting

Although Yamaha motorcycles receive a thorough inspection before shipment from the factory, trouble may occur during operation. Any problem in the fuel, compression, or ignition systems, for example, can cause poor starting and loss of power.

The following troubleshooting charts represent quick and easy procedures for checking these vital systems yourself. However, should your motorcycle require any repair, take it to a Yamaha dealer, whose skilled technicians have the necessary tools, experience, and know-how to service the motorcycle properly.

Use only genuine Yamaha replacement parts. Imitation parts may look like Yamaha parts, but they are often inferior, have a shorter service life and can lead to expensive repair bills.

# PERIODIC MAINTENANCE AND MINOR REPAIR

EAU02990

## Troubleshooting charts

### Starting problems or poor engine performance

EW000125



**WARNING**

Keep away open flames and do not smoke while checking or working on the fuel system.

#### 1. Fuel

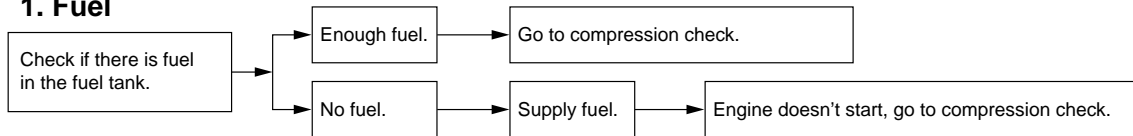

#### 2. Compression

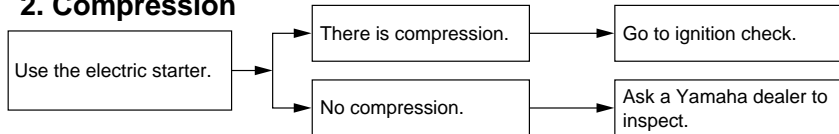

#### 3. Ignition

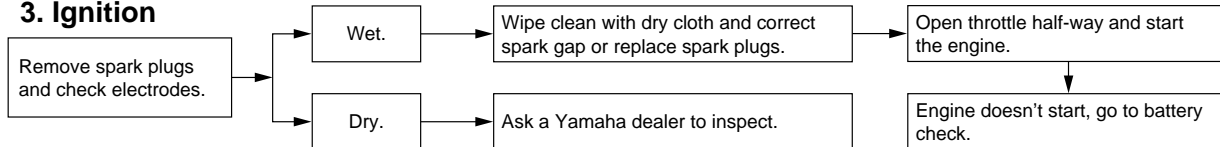

#### 4. Battery

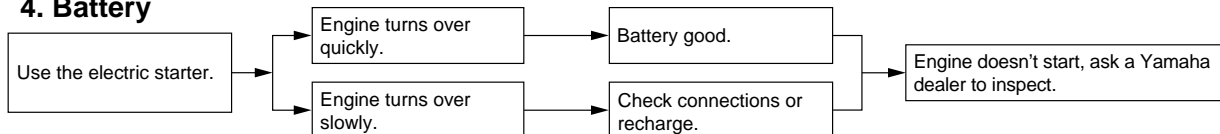

# PERIODIC MAINTENANCE AND MINOR REPAIR

## Engine overheating

EW000070

### **⚠ WARNING**

- Do not remove the radiator cap when the engine and radiator are hot. Scalding hot fluid and steam may be blown out under pressure, which could cause serious injury. Be sure to wait until the engine has cooled.
- After removing the radiator cap retaining bolt, place a thick rag, like a towel, over the radiator cap, and then slowly rotate the cap counterclockwise to the detent to allow any residual pressure to escape. When the hissing sound has stopped, press down on the cap while turning it counterclockwise, and then remove the cap.

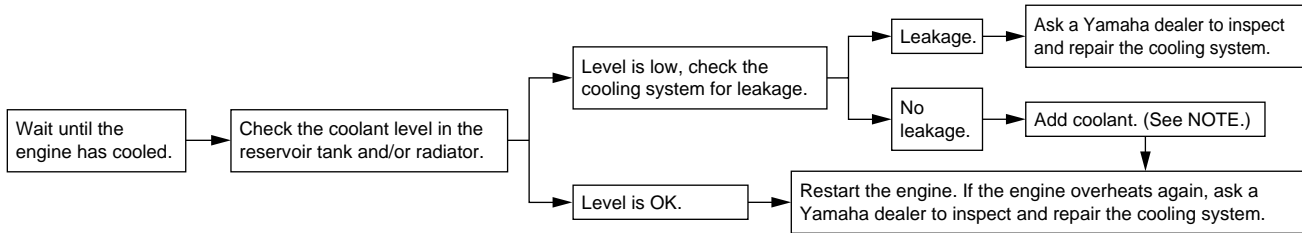

### **NOTE:**

If coolant is not available, tap water can be temporarily used instead, provided that it is changed to the recommended coolant as soon as possible.

# MOTORCYCLE CARE AND STORAGE

---

---

|               |     |
|---------------|-----|
| Care .....    | 7-1 |
| Storage ..... | 7-4 |

## Care

While the open design of a motorcycle reveals the attractiveness of the technology, it also makes it more vulnerable. Rust and corrosion can develop even if high-quality components are used. A rusty exhaust pipe may go unnoticed on a car, however, it detracts from the overall appearance of a motorcycle. Frequent and proper care does not only comply with the terms of the warranty, but it will also keep your motorcycle looking good, extend its life and optimize its performance.

## Before cleaning

1. Cover the muffler outlet with a plastic bag after the engine has cooled down.
2. Make sure that all caps and covers as well as all electrical couplers and connectors, including the spark plug caps, are tightly installed.
3. Remove extremely stubborn dirt, like oil burnt onto the crankcase, with a degreasing agent and a brush, but never apply such products onto seals, gaskets, sprockets, the drive chain and wheel axles. Always rinse the dirt and degreaser off with water.

## Cleaning

ECA00010

### CAUTION:

- **Avoid using strong acidic wheel cleaners, especially on spoked wheels. If such products are used on hard-to-remove dirt, do not leave the cleaner on the affected area any longer than instructed. Also, thoroughly rinse the area off with water, immediately dry it, and then apply a corrosion protection spray.**
- **Improper cleaning can damage windshields, cowlings, panels and other plastic parts. Use only a soft, clean cloth or sponge with mild detergent and water to clean plastic.**

# MOTORCYCLE CARE AND STORAGE

---

---

- Do not use any harsh chemical products on plastic parts. Be sure to avoid using cloths or sponges which have been in contact with strong or abrasive cleaning products, solvent or thinner, fuel (gasoline), rust removers or inhibitors, brake fluid, antifreeze or electrolyte.
- Do not use high-pressure washers or steam-jet cleaners since they cause water seepage and deterioration in the following areas: seals (of wheel and swing-arm bearings, fork and brakes), electric components (couplers, connectors, instruments, switches and lights), breather hoses and vents.

- For motorcycles equipped with a windshield: Do not use strong cleaners or hard sponges as they will cause dulling or scratching. Some cleaning compounds for plastic may leave scratches on the windshield. Test the product on a small hidden part of the windshield to make sure that it does not leave any marks. If the windshield is scratched, use a quality plastic polishing compound after washing.
- 

## After normal use

Remove dirt with warm water, a mild detergent, and a soft, clean sponge, and then rinse thoroughly with clean water. Use a toothbrush or bottlebrush for hard-to-reach areas. Stubborn dirt and insects will come off more easily if the area is covered with a wet cloth for a few minutes before cleaning.

## After riding in the rain, near the sea or on salt-sprayed roads

Since sea salt or salt sprayed on roads during winter are extremely corrosive in combination with water, carry out the following steps after each ride in the rain, near the sea or on salt-sprayed roads.

**NOTE:** \_\_\_\_\_  
Salt sprayed on roads in the winter may remain well into spring.

---

1. Clean the motorcycle with cold water and a mild detergent, after the engine has cooled down.

# MOTORCYCLE CARE AND STORAGE

---

---

ECA00012

## **CAUTION:**

**Do not use warm water since it increases the corrosive action of the salt.**

---

2. Apply a corrosion protection spray on all metal, including chrome- and nickel-plated, surfaces to prevent corrosion.

## **After cleaning**

1. Dry the motorcycle with a chamois or an absorbing cloth.
2. Immediately dry the drive chain and lubricate it to prevent it from rusting.
3. Use a chrome polish to shine chrome, aluminum and stainless-steel parts, including the exhaust system. (Even the thermally induced discoloring of stainless-steel exhaust systems can be removed through polishing.)
4. To prevent corrosion, it is recommended to apply a corrosion protection spray on all metal, including chrome- and nickel-plated, surfaces.
5. Use spray oil as a universal cleaner to remove any remaining dirt.
6. Touch up minor paint damage caused by stones, etc.
7. Wax all painted surfaces.
8. Let the motorcycle dry completely before storing or covering it.

EWA00001

## **! WARNING**

- **Make sure that there is no oil or wax on the brakes or tires. If necessary, clean the brake discs and brake linings with a regular brake disc cleaner or acetone, and wash the tires with warm water and a mild detergent.**
  - **Before operating the motorcycle test its braking performance and cornering behavior.**
-



# MOTORCYCLE CARE AND STORAGE

ECA00013

## CAUTION:

- Apply spray oil and wax sparingly and make sure to wipe off any excess.
- Never apply oil or wax to any rubber and plastic parts, but treat them with a suitable care product.
- Avoid using abrasive polishing compounds as they will wear away the paint.

## NOTE:

Consult a Yamaha dealer for advice on what products to use.

## Storage

### Short-term

Always store your motorcycle in a cool, dry place and, if necessary, protect it against dust with a porous cover.

ECA00014

## CAUTION:

- Storing the motorcycle in a poorly ventilated room or covering it with a tarp, while it is still wet, will allow water and humidity to seep in and cause rust.
- To prevent corrosion, avoid damp cellars, stables (because of the presence of ammonia) and areas where strong chemicals are stored.

## Long-term

Before storing your motorcycle for several months:

1. Follow all the instructions in the “Care” section of this chapter.
2. For motorcycles equipped with a fuel cock that has an “OFF” position: Turn the fuel cock lever to “OFF”.
3. Drain the carburetor float chamber by loosening the drain bolt; this will prevent fuel deposits from building up. Pour the drained fuel into the fuel tank.
4. Fill up the fuel tank and add fuel stabilizer (if available) to prevent the fuel tank from rusting and the fuel from deteriorating.
5. Perform the following steps to protect the cylinders, piston rings, etc. from corrosion.
  - a. Remove the spark plug caps and spark plugs.
  - b. Pour a teaspoonful of engine oil into each spark plug bore.

# MOTORCYCLE CARE AND STORAGE

---

---

- c. Install the spark plug caps onto the spark plugs, and then place the spark plugs on the cylinder head so that the electrodes are grounded. (This will limit sparking during the next step.)
- d. Turn the engine over several times with the starter. (This will coat the cylinder walls with oil.)
- e. Remove the spark plug caps from the spark plugs, and then install the spark plugs and the spark plug caps.
7. Check and, if necessary, correct the tire air pressure, and then lift the motorcycle so that both of its wheels are off the ground. Alternatively, turn the wheels a little every month in order to prevent the tires from becoming degraded in one spot.
8. Cover the muffler outlet with a plastic bag to prevent moisture from entering it.
9. Remove the battery and fully charge it. Store it in a cool, dry place and charge it once a month. Do not store the battery in an excessively cold or warm place (less than 0 °C or more than 30 °C). For more information on storing the battery, see page 6-35.

EWA00003

## **WARNING**

**To prevent damage or injury from sparking, make sure to ground the spark plug electrodes while turning the engine over.**

6. Lubricate all control cables and the pivoting points of all levers and pedals as well as of the sidestand/centerstand.

**NOTE:** \_\_\_\_\_  
Make any necessary repairs before storing the motorcycle.  
\_\_\_\_\_

Specifications ..... 8-1  
Conversion table ..... 8-5

## Specifications

|   |   |
|---|---|
| <b>Model</b>                                      | <b>FZS600/FZS600SP</b>                              |
| <b>Dimensions</b>                                 |   |
| Overall length                                    | 2,080 mm (except for N, SF)<br>2,175 mm (for N, SF) |
| Overall width                                     | 710 mm  |
| Overall height                                    | 1,170 mm  |
| Seat height                                       | 790 mm  |
| Wheelbase   | 1,415 mm  |
| Ground clearance                                  | 130 mm  |
| Minimum turning radius                            | 2,900 mm  |
| <b>Basic weight (with oil and full fuel tank)</b> | <b>210 kg</b>                                       |
| <b>Engine</b>                                     |   |
| Engine type                                       | Liquid-cooled 4-stroke, DOHC                        |
| Cylinder arrangement                              | Forward-inclined parallel 4-cylinder                |
| Displacement                                      | 599 cm <sup>3</sup>                                 |
| Bore × Stroke                                     | 62.0 × 49.6 mm                                      |
| Compression ratio                                 | 12:1  |
| Starting system                                   | Electric starter                                    |
| Lubrication system                                | Wet sump  |

## Engine oil

Type

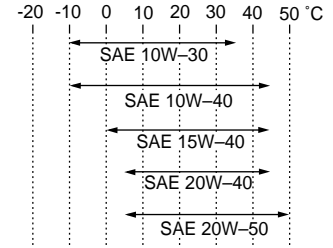

Recommended engine oil classification

API Service SE, SF, SG type or higher

### CAUTION:

**Be sure to use motor oils that do not contain anti-friction modifiers. Passenger car motor oils (often labeled "Energy Conserving") contain anti-friction additives which will cause clutch and/or starter clutch slippage, resulting in reduced component life and poor engine performance.**

Quantity

|  |       |
|--|-------|
| Without oil filter cartridge replacement | 2.5 L |
| With oil filter cartridge replacement    | 2.7 L |
| Total amount (dry engine)                | 3.5 L |

# SPECIFICATIONS

|   |  |
|---|--|
| <b>Cooling system capacity (total amount)</b> | 1.95 L   |
| <b>Air filter</b>                             | Dry type element   |
| <b>Fuel</b>                                   |  |
| Type  | Regular unleaded gasoline  |
| Fuel tank capacity                            | 20 L   |
| Fuel reserve amount                           | 3.5 L  |
| <b>Carburetor</b>                             |  |
| Manufacturer                                  | MIKUNI   |
| Model × quantity                              | BSR33 × 4  |
| <b>Spark plug</b>                             |  |
| Manufacturer/type                             |  |
| Except for D, F                               | NGK / CR8E, CR9E or<br>DENSO / U24ESR-N, U27ESR-N                    |
| For D, F                                      | NGK / CR7E, CR8E, CR9E or<br>DENSO / U22ESR-N,<br>U24ESR-N, U27ESR-N |
| Gap   | 0.7–0.8 mm   |
| <b>Clutch type</b>                            | Wet, multiple-disc   |
| <b>Transmission</b>                           |  |
| Primary reduction system                      | Spur gear  |
| Primary reduction ratio                       | 1.708  |
| Secondary reduction system                    | Chain drive  |
| Secondary reduction ratio                     | 3.200  |

|   |                       |
|---|-----------------------|
| Number of drive chain sprocket teeth (rear/front) | 48/15                 |
| Transmission type                                 | Constant mesh 6-speed |
| Operation   | Left foot             |
| Gear ratio  |                       |
|   | 1st      2.846        |
|   | 2nd      1.947        |
|   | 3rd      1.545        |
|   | 4th      1.333        |
|   | 5th      1.190        |
|   | 6th      1.074        |

**Chassis**

|              |               |
|--------------|---------------|
| Frame type   | Double cradle |
| Caster angle | 24°           |
| Trail        | 88 mm         |

**Tires**

|                        |  |
|------------------------|--|
| Front                  |  |
| Type                   | Tubeless                               |
| Size                   | 110 / 70 ZR17 (54W)                    |
| Manufacturer/<br>model | Bridgestone / BT-57F<br>Dunlop / D207F |

# SPECIFICATIONS

## Rear

|                        |  |
|------------------------|--|
| Type                   | Tubeless                               |
| Size                   | 160 / 60 ZR17 (69W)                    |
| Manufacturer/<br>model | Bridgestone / BT-57R<br>Dunlop / D207J |

Maximum load\* 187 kg

Tire air pressure (measured  
on cold tires)

Up to 90 kg\*

|       |  |
|-------|--|
| Front | 225 kPa (2.25 kg/cm <sup>2</sup> , 2.25 bar) |
| Rear  | 250 kPa (2.50 kg/cm <sup>2</sup> , 2.50 bar) |

90 kg–maximum\*

|       |  |
|-------|--|
| Front | 225 kPa (2.25 kg/cm <sup>2</sup> , 2.25 bar) |
| Rear  | 290 kPa (2.90 kg/cm <sup>2</sup> , 2.90 bar) |

High-speed riding

|       |  |
|-------|--|
| Front | 225 kPa (2.25 kg/cm <sup>2</sup> , 2.25 bar) |
| Rear  | 290 kPa (2.90 kg/cm <sup>2</sup> , 2.90 bar) |

\* Total weight of rider, passenger, cargo and accessories.

## Wheels

### Front

|      |              |
|------|--------------|
| Type | Cast wheel   |
| Size | 17 × MT 3.00 |

## Rear

|      |              |
|------|--------------|
| Type | Cast wheel   |
| Size | 17 × MT 5.00 |

## Brakes

### Front

|           |                 |
|-----------|-----------------|
| Type      | Dual disc brake |
| Operation | Right hand      |
| Fluid     | DOT 4           |

### Rear

|           |                   |
|-----------|-------------------|
| Type      | Single disc brake |
| Operation | Right foot        |
| Fluid     | DOT 4             |

## Suspension

### Front

Telescopic fork

### Rear

Swingarm (link suspension)

## Spring/shock absorber

### Front

Coil spring / oil damper

### Rear

Coil spring / gas-oil damper

## Wheel travel

### Front

120 mm

### Rear

120 mm

## Electrical system

|                   |  |
|-------------------|--|
| Ignition system   | Transistorized coil ignition (digital) |
| Charging system   |  |
| Model             | A.C. magneto                           |
| Standard output   | 14 V, 18 A @ 5,000 r/min               |
| Battery           |  |
| Model             | GT12B-4                                |
| Voltage, capacity | 12 V, 10 Ah                            |

## Headlight type

Quartz bulb (halogen)

## Bulb voltage, wattage × quantity

|                                    |                   |
|------------------------------------|-------------------|
| Headlight                          | 12 V, 60/55 W × 1 |
|                                    | 12 V, 55 W × 1    |
| Auxiliary light                    | 12 V, 5 W × 1     |
| Tail/brake light                   | 12 V, 5/21 W × 2  |
| Turn signal light                  | 12 V, 21 W × 4    |
| Meter lighting                     | 12 V, 2 W × 3     |
| Neutral indicator light            | 14 V, 1.4 W × 1   |
| High beam indicator light          | 14 V, 1.4 W × 1   |
| Oil level warning light            | 14 V, 1.4 W × 1   |
| Turn signal indicator light        | 14 V, 1.4 W × 2   |
| Fuel level warning indicator light | 12 V, 2 W × 1     |
| Coolant temperature warning light  | LED               |

## Fuses

|                       |      |
|-----------------------|------|
| Main fuse             | 30 A |
| Headlight fuse        | 20 A |
| Signaling system fuse | 20 A |
| Ignition fuse         | 20 A |
| Radiator fan fuse     | 10 A |
| Hazard fuse           | 10 A |
| Odometer fuse         | 5 A  |

# SPECIFICATIONS

EAU01064

## Conversion table

All specification data in this manual are listed in SI and METRIC UNITS.

Use this table to convert METRIC unit data to IMPERIAL unit data.

Example

| METRIC |   | MULTIPLIER | = | IMPERIAL |
|--------|---|------------|---|----------|
| ** mm  | × | 0.03937    | = | ** in    |
| 2 mm   | × | 0.03937    | = | 0.08 in  |

## Conversion table

| METRIC TO IMPERIAL  |                       |            |                           |
|---------------------|-----------------------|------------|---------------------------|
|                     | Metric unit           | Multiplier | Imperial unit             |
| Torque              | m·kg                  | 7.233      | ft·lb                     |
|                     | m·kg                  | 86.794     | in·lb                     |
|                     | cm·kg                 | 0.0723     | ft·lb                     |
|                     | cm·kg                 | 0.8679     | in·lb                     |
| Weight              | kg                    | 2.205      | lb                        |
|                     | g                     | 0.03527    | oz                        |
| Speed               | km/h                  | 0.6214     | mi/h                      |
| Distance            | km                    | 0.6214     | mi                        |
|                     | m                     | 3.281      | ft                        |
|                     | m                     | 1.094      | yd                        |
|                     | cm                    | 0.3937     | in                        |
|                     | mm                    | 0.03937    | in                        |
| Volume,<br>Capacity | cc (cm <sup>3</sup> ) | 0.03527    | oz (IMP liq.)             |
|                     | cc (cm <sup>3</sup> ) | 0.06102    | cu-in                     |
|                     | L (liter)             | 0.8799     | qt (IMP liq.)             |
|                     | L (liter)             | 0.2199     | gal (IMP liq.)            |
| Miscellaneous       | kg/mm                 | 55.997     | lb/in                     |
|                     | kg/cm <sup>2</sup>    | 14.2234    | psi (lb/in <sup>2</sup> ) |
|                     | Centigrade (°C)       | 9/5 + 32   | Fahrenheit (°F)           |



|                                     |     |
|-------------------------------------|-----|
| Identification numbers .....        | 9-1 |
| Key identification number .....     | 9-1 |
| Vehicle identification number ..... | 9-1 |
| Model label .....                   | 9-2 |

## Identification numbers

EAU02944

Record the key identification number, vehicle identification number and model label information in the spaces provided below for assistance when ordering spare parts from a Yamaha dealer or for reference in case the vehicle is stolen.

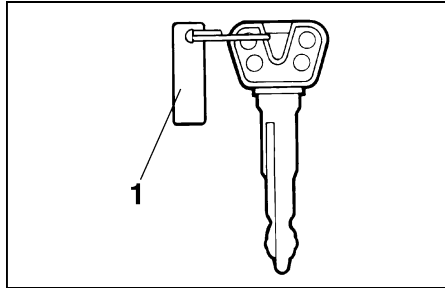

1. Key identification number

EAU01041

### Key identification number

The key identification number is stamped into the key tag. Record this number in the space provided and use it for reference when ordering a new key.

1. KEY IDENTIFICATION NUMBER:

2. VEHICLE IDENTIFICATION NUMBER:

3. MODEL LABEL INFORMATION:

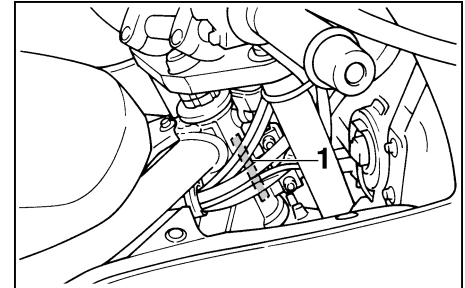

1. Vehicle identification number

EAU01043

### Vehicle identification number

The vehicle identification number is stamped into the steering head pipe. Record this number in the space provided.

**NOTE:** \_\_\_\_\_

The vehicle identification number is used to identify your motorcycle and may be used to register your motorcycle with the licensing authority in your area.

\_\_\_\_\_

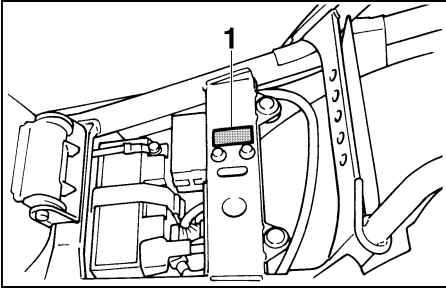

1. Model label

EAU03171

## Model label

The model label is affixed to the frame under the passenger seat. (See page 3-12 for seat removal and installation procedures.) Record the information on this label in the space provided. This information will be needed when ordering spare parts from a Yamaha dealer.

# INDEX

## A

- Air filter .....6-17
- Anti-theft alarm .....3-6

## B

- Battery .....6-35
- Brake and clutch levers, checking  
and lubricating .....6-31
- Brake and shift pedals, checking  
and lubricating .....6-31
- Brake fluid, changing .....6-28
- Brake fluid level, checking.....6-27
- Brake lever.....3-9
- Brake light switch (rear), adjusting .....6-26
- Brake pads, checking.....6-26
- Brake pedal.....3-9
- Brake pedal position, adjusting .....6-25

## C

- Cables, checking and lubricating.....6-30
- Carburetors, adjusting.....6-19
- Care .....7-1
- Centerstand and sidestand, checking  
and lubricating .....6-32
- Clutch lever.....3-8
- Clutch lever free play, adjusting .....6-24
- Conversion table .....8-5
- Coolant .....6-12
  - Changing.....6-13
  - Checking .....6-12
- Coolant temperature warning light.....3-3

## D

- Dimmer switch .....3-7
- Drive chain, lubricating .....6-29
- Drive chain slack .....6-28
  - Adjusting .....6-29
  - Checking.....6-28

## E

- Engine break-in .....5-4
- Engine oil and oil filter cartridge .....6-9
- Engine stop switch.....3-8

## F

- Front fork, adjusting.....3-13
- Front fork, checking .....6-33
- Front wheel .....6-39
  - Installing.....6-40
  - Removing.....6-39
- Fuel .....3-11
- Fuel consumption, tips for reducing .....5-4
- Fuel gauge .....3-6
- Fuel level warning light .....3-4
- Fuel tank breather hose.....3-11
- Fuel tank cap.....3-10
- Fuse, replacing.....6-36

## H

- Handlebar switches .....3-7
- Hazard switch .....3-7
- Headlight bulb, replacing .....6-37
- Helmet holder .....3-13
- High beam indicator light .....3-3
- Horn switch .....3-7

## I

- Identification numbers .....9-1
- Idling speed, adjusting .....6-19
- Ignition circuit cut-off system .....3-16
- Indicator and warning lights.....3-3

## K

- Key identification number .....9-1

## L

- Light switch .....3-8
- Luggage strap holders .....3-15

## M

- Main switch/steering lock .....3-1
- Maintenance and lubrication, periodic .....6-2
- Model label .....9-2

## N

- Neutral indicator light .....3-3

## O

- Oil level warning light .....3-3

## P

- Panels, removing and installing.....6-5
- Parking.....5-5
- Part locations .....2-1
- Pass switch .....3-7
- Pre-operation check list.....4-1

## R

|                  |      |
|------------------|------|
| Rear wheel ..... | 6-41 |
| Installing ..... | 6-42 |
| Removing .....   | 6-41 |

## S

|   |      |
|---|------|
| Safety information .....                  | 1-1  |
| Seat .....                                | 3-12 |
| Self-diagnosis device .....               | 3-5  |
| Shifting .....                            | 5-3  |
| Shift pedal .....                         | 3-9  |
| Shift points (for Switzerland only) ..... | 5-4  |
| Shock absorber assembly, adjusting .....  | 3-14 |
| Sidestand .....                           | 3-15 |
| Spark plugs, checking .....               | 6-7  |
| Specifications .....                      | 8-1  |
| Speedometer unit .....                    | 3-4  |
| Starter (choke) lever .....               | 3-12 |
| Starting a cold engine .....              | 5-1  |
| Starting a warm engine .....              | 5-3  |
| Start switch .....                        | 3-8  |
| Steering, checking .....                  | 6-33 |
| Storage .....                             | 7-4  |
| Storage compartment .....                 | 3-13 |
| Suspension (rear), lubricating .....      | 6-33 |

## T

|   |      |
|---|------|
| Tachometer .....                          | 3-5  |
| Tail/brake light bulb, replacing .....    | 6-38 |
| Throttle cable free play, adjusting ..... | 6-20 |

|  |      |
|--|------|
| Throttle grip and cable, checking<br>and lubricating ..... | 6-31 |
| Tires .....  | 6-21 |
| Tool kit .....   | 6-1  |
| Troubleshooting .....                                      | 6-43 |
| Troubleshooting charts .....                               | 6-44 |
| Turn signal indicator lights .....                         | 3-3  |
| Turn signal light bulb, replacing .....                    | 6-39 |
| Turn signal switch .....                                   | 3-7  |

## V

|                                     |      |
|-------------------------------------|------|
| Valve clearance, adjusting .....    | 6-20 |
| Vehicle identification number ..... | 9-1  |

## W

|                                |      |
|--------------------------------|------|
| Wheel bearings, checking ..... | 6-34 |
| Wheels .....                   | 6-24 |





PRINTED ON RECYCLED PAPER

PRINTED IN JAPAN  
2000 · 5 - 0.5 × 3 CR  
(E)