



**OWNER'S MANUAL**



**YZF-R6**

**5MT-28199-E0**



Welcome to the Yamaha world of motorcycling!

As the owner of a YZF-R6, you are benefiting from Yamaha's vast experience and newest technology regarding the design and manufacture of high-quality products, which have earned Yamaha a reputation for dependability.

Please take the time to read this manual thoroughly, so as to enjoy all advantages of your YZF-R6. The owner's manual does not only instruct you in how to operate, inspect and maintain your motorcycle, but also in how to safeguard yourself and others from trouble and injury.

In addition, the many tips given in this manual will help keep your motorcycle in the best possible condition. If you have any further questions, do not hesitate to contact your Yamaha dealer.

The Yamaha team wishes you many safe and pleasant rides. So, remember to put safety first!

# IMPORTANT MANUAL INFORMATION

---

---

Particularly important information is distinguished in this manual by the following notations:



The Safety Alert Symbol means **ATTENTION! BECOME ALERT! YOUR SAFETY IS INVOLVED!**



Failure to follow **WARNING** instructions could result in severe injury or death to the motorcycle operator, a bystander, or a person inspecting or repairing the motorcycle.

**CAUTION:**

A **CAUTION** indicates special precautions that must be taken to avoid damage to the motorcycle.

**NOTE:**

A **NOTE** provides key information to make procedures easier or clearer.

**NOTE:** \_\_\_\_\_

- This manual should be considered a permanent part of this motorcycle and should remain with it even if the motorcycle is subsequently sold.
  - Yamaha continually seeks advancements in product design and quality. Therefore, while this manual contains the most current product information available at the time of printing, there may be minor discrepancies between your motorcycle and this manual. If you have any questions concerning this manual, please consult your Yamaha dealer.
-

# IMPORTANT MANUAL INFORMATION

---

---

EW000002

 **WARNING**

**PLEASE READ THIS MANUAL CAREFULLY AND COMPLETELY BEFORE OPERATING THIS MOTORCYCLE.**

---

# **IMPORTANT MANUAL INFORMATION**

---

---

EAU03337

**YZF-R6  
OWNER'S MANUAL  
© 2000 by Yamaha Motor Co., Ltd.  
1st Edition, July 2000  
All rights reserved.  
Any reprinting or unauthorized use  
without the written permission of  
Yamaha Motor Co., Ltd.  
is expressly prohibited.  
Printed in Japan.**

|   |   |
|---|---|
| 1 GIVE SAFETY THE RIGHT OF WAY          | 1 |
| 2 DESCRIPTION                           | 2 |
| 3 INSTRUMENT AND CONTROL FUNCTIONS      | 3 |
| 4 PRE-OPERATION CHECKS                  | 4 |
| 5 OPERATION AND IMPORTANT RIDING POINTS | 5 |
| 6 PERIODIC MAINTENANCE AND MINOR REPAIR | 6 |
| 7 MOTORCYCLE CARE AND STORAGE           | 7 |
| 8 SPECIFICATIONS                        | 8 |
| 9 CONSUMER INFORMATION                  | 9 |
| INDEX                                   |   |







# GIVE SAFETY THE RIGHT OF WAY

---

---

GIVE SAFETY THE RIGHT OF WAY ..... 1-1



Motorcycles are fascinating vehicles, which can give you an unsurpassed feeling of power and freedom. However, they also impose certain limits, which you must accept; even the best motorcycle does not ignore the laws of physics.

Regular care and maintenance are essential for preserving value and operating condition of your motorcycle. Moreover, what is true for the motorcycle is also true for the rider: good performance depends on being in good shape. Riding under the influence of medication, drugs and alcohol is, of course, out of the question. Motorcycle riders—more than car drivers—must always be at their mental and physical best. Under the influence of even small amounts of alcohol, there is a tendency to take dangerous risks.

Protective clothing is as essential for the motorcycle rider as seat belts are for car drivers and passengers. Always wear a complete motorcycle suit (whether made of leather or tear-resistant synthetic materials with protectors), sturdy boots, motorcycle gloves and a properly fitting helmet. Optimum protective wear, however, should not encourage carelessness. Although full-coverage helmets and suits, in particular, create an illusion of total safety and protection, motorcyclists will always be vulnerable. Riders who lack critical self-control run the risk of going too fast and are apt to take chances. This is even more dangerous in wet weather. The good motorcyclist rides safely, predictably and defensively—avoiding all dangers, including those caused by others.

Enjoy your ride!

|                                |     |
|--------------------------------|-----|
| Left view .....                | 2-1 |
| Right view.....                | 2-2 |
| Controls and instruments ..... | 2-3 |

## Left view

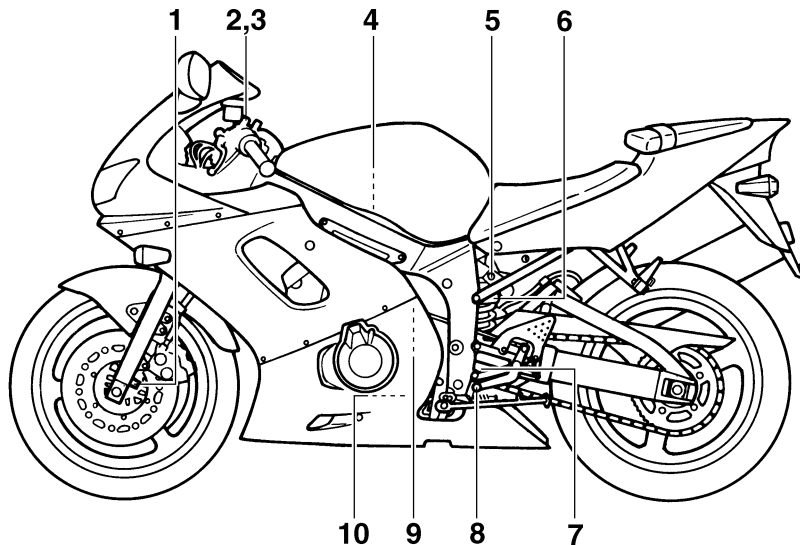

- |  |             |   |             |
|--|-------------|---|-------------|
| 1. Front fork compression damping force adjusting screw          | (page 3-18) | 6. Rear shock absorber spring preload adjusting ring        | (page 3-19) |
| 2. Front fork rebound damping force adjusting screw              | (page 3-18) | 7. Rear shock absorber rebound damping force adjusting knob | (page 3-19) |
| 3. Front fork spring preload adjusting bolt                      | (page 3-17) | 8. Shift pedal  | (page 3-9)  |
| 4. Air filter element  | (page 6-17) | 9. Coolant reservoir  | (page 6-13) |
| 5. Rear shock absorber compression damping force adjusting screw | (page 3-20) | 10. Engine oil filter cartridge                             | (page 6-10) |

## Right view

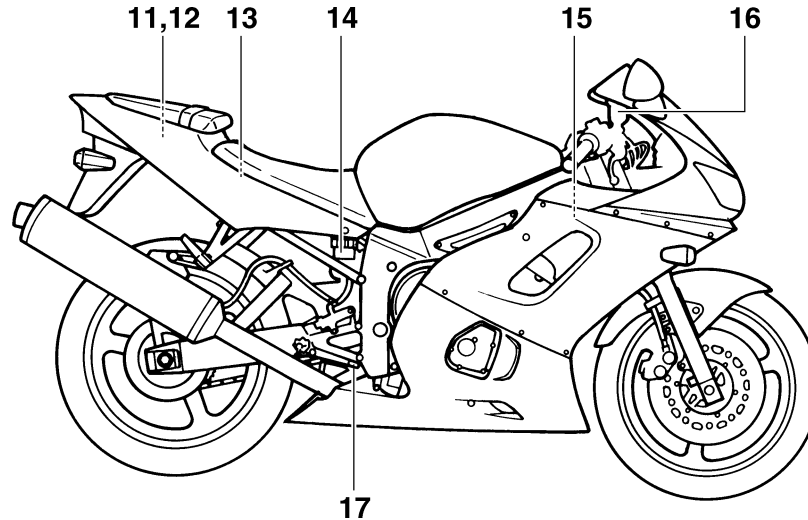

- |                                 |             |
|---------------------------------|-------------|
| 11. Luggage strap holders       | (page 3-22) |
| 12. Owner's tool kit            | (page 6-1)  |
| 13. Fuses                       | (page 6-38) |
| 14. Rear brake fluid reservoir  |             |
| 15. Radiator cap                | (page 6-15) |
| 16. Front brake fluid reservoir |             |
| 17. Brake pedal                 | (page 3-10) |

# DESCRIPTION

---

## Controls and instruments

2

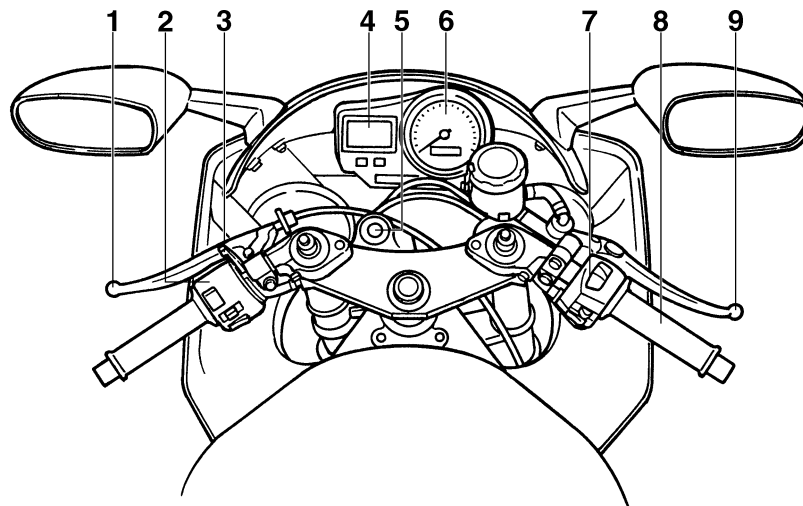

- 1. Clutch lever
- 2. Left handlebar switches
- 3. Starter (choke) lever
- 4. Speedometer unit
- 5. Main switch/steering lock

(page 3-9)  
(page 3-7)  
(page 3-13)  
(page 3-5)  
(page 3-1)

- 6. Tachometer
- 7. Right handlebar switches
- 8. Throttle grip
- 9. Brake lever

(page 3-6)  
(page 3-8)  
(page 6-21)  
(page 3-9)

# INSTRUMENT AND CONTROL FUNCTIONS

|                                    |      |  |      |
|------------------------------------|------|--|------|
| Main switch/steering lock .....    | 3-1  | Fuel tank breather hose .....                            | 3-12 |
| Indicator and warning lights ..... | 3-2  | Starter (choke) lever .....                              | 3-13 |
| Speedometer unit .....             | 3-5  | Seats .....  | 3-13 |
| Tachometer .....                   | 3-6  | Helmet holders .....                                     | 3-15 |
| Self-diagnosis device .....        | 3-7  | Storage compartment .....                                | 3-15 |
| Handlebar switches .....           | 3-7  | Adjusting the front fork .....                           | 3-17 |
| Clutch lever .....                 | 3-9  | Adjusting the shock absorber assembly .....              | 3-19 |
| Shift pedal .....                  | 3-9  | Matching the front and rear suspension<br>settings ..... | 3-21 |
| Brake lever .....                  | 3-9  | Luggage strap holders .....                              | 3-22 |
| Brake pedal .....                  | 3-10 | Sidestand .....  | 3-22 |
| Anti-theft alarm (optional) .....  | 3-10 | Ignition circuit cut-off system .....                    | 3-23 |
| Fuel tank cap .....                | 3-11 |  |      |
| Fuel .....                         | 3-11 |  |      |

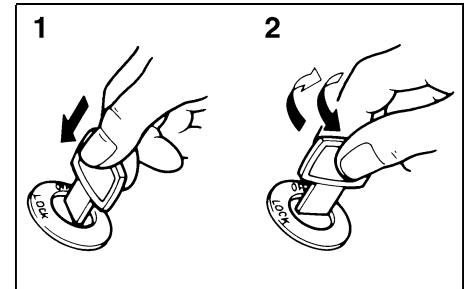
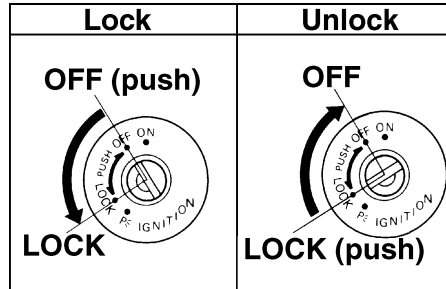
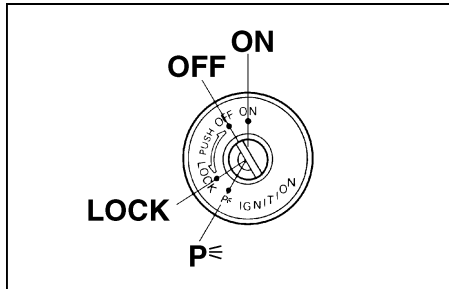

1. Push.
2. Turn.

EAU00029

## Main switch/steering lock

The main switch/steering lock controls the ignition and lighting systems, and is used to lock the steering. The various positions are described below.

### ON

All electrical systems are supplied with power, and the engine can be started. The key cannot be removed.

EAU00036

### OFF

All electrical systems are off. The key can be removed.

EAU00038

EAU00040

### LOCK

The steering is locked, and all electrical systems are off. The key can be removed.

#### To lock the steering

1. Turn the handlebars all the way to the left.
2. Push the key in from the "OFF" position, and then turn it to "LOCK" while still pushing it.
3. Remove the key.

#### To unlock the steering

Push the key in, and then turn it to "OFF" while still pushing it.

EW000016

### **! WARNING**

Never turn the key to "OFF" or "LOCK" while the motorcycle is moving, otherwise the electrical systems will be switched off, which may result in loss of control or an accident. Make sure that the motorcycle is stopped before turning the key to "OFF" or "LOCK".



# INSTRUMENT AND CONTROL FUNCTIONS

## P⊆ (Parking)

EAU01237

The steering is locked, and the taillights and auxiliary lights are on, but all other electrical systems are off. The key can be removed.

The steering must be locked before the key can be turned to “P⊆”.

ECA00043

### CAUTION:

**Do not use the parking position for an extended length of time, otherwise the battery may discharge.**

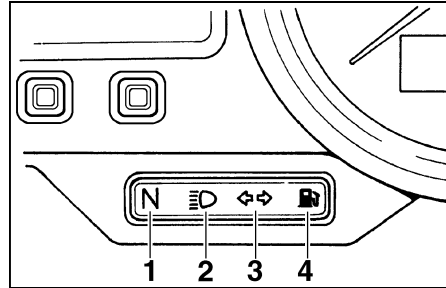

1. Neutral indicator light “N”
2. High beam indicator light “≡○”
3. Turn signal indicator light “↔”
4. Fuel level warning light “⛢”

EAU03034

## Indicator and warning lights

EAU00061

### Neutral indicator light “N”

This indicator light comes on when the transmission is in the neutral position.

EAU00063

### High beam indicator light “≡○”

This indicator light comes on when the high beam of the headlight is switched on.

EAU00057

### Turn signal indicator light “↔”

This indicator light flashes when the turn signal switch is pushed to the left or right.

EAU003284

### Fuel level warning light “⛢”

This warning light comes on when the fuel level drops below approximately 3.5 L. When this occurs, refuel as soon as possible.

The electrical circuit of the warning light can be checked according to the following procedure.

1. Turn the key to “ON”.
2. If the warning light does not come on, have a Yamaha dealer check the electrical circuit.

### NOTE:

This model is equipped with a self-diagnosis device for the fuel level warning light circuit. (See page 3-23 for an explanation of the self-diagnosis device.)

# INSTRUMENT AND CONTROL FUNCTIONS

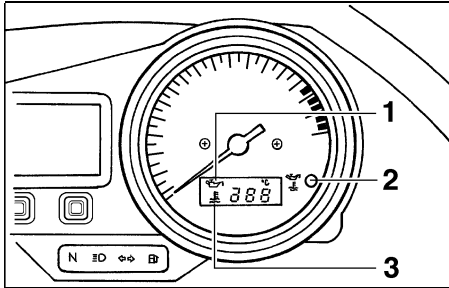

EC000118



1. Oil level symbol “

EAU03723\*

## Oil level/coolant temperature warning light “ This warning light has the following three functions.

- When the engine oil level is low, the warning light comes on and symbol “
  - When the coolant temperature is too high, the warning light comes on and symbol “

To check that the warning light is working properly:

- Put the transmission in neutral or apply the clutch lever.
- Turn the engine stop switch to “

If the warning light does not come on, have a Yamaha dealer inspect the electrical circuit.

## CAUTION:

- Do not operate the motorcycle until you know that the engine oil level is sufficient.
- Do not operate the engine if it is overheated.

## NOTE:

Even if the oil is filled to the specified level, the warning light may flicker when riding on a slope or during sudden acceleration or deceleration, but this is normal.

# INSTRUMENT AND CONTROL FUNCTIONS

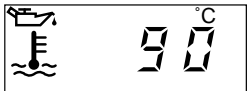
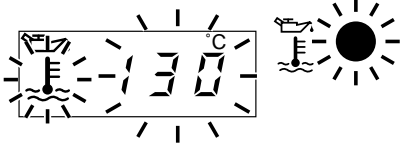
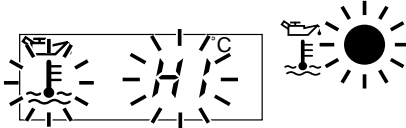
| Coolant temperature | Display   | Conditions  | What to do   |
|---------------------|---|---|--|
| 0–40 °C             |  | Symbol and message “LO” are displayed.                    | OK. Go ahead with riding.  |
| 41–117 °C           |  | Symbol and temperature are displayed.                     | OK. Go ahead with riding.  |
| 118–140 °C          |  | Symbol and temperature flash.<br>Warning light comes on.  | Stop the motorcycle and allow it to idle until the coolant temperature goes down.<br>If the temperature does not go down, stop the engine. (See the “Engine overheating” section on page 6-46 for further instructions.) |
| Above 140 °C        |  | Symbol and message “HI” flash.<br>Warning light comes on. | Stop the engine and allow it to cool. (See the “Engine overheating” section on page 6-46 for further instructions.)  |

# INSTRUMENT AND CONTROL FUNCTIONS

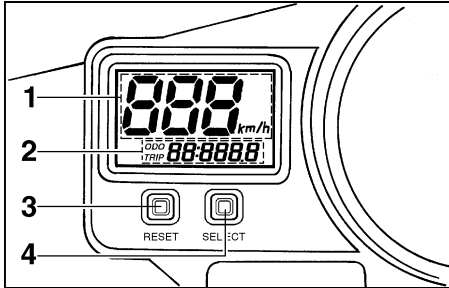

1. Speedometer
2. Clock/odometer
3. "RESET" button
4. "SELECT" button

## Speedometer unit

EAU03244

The speedometer unit is equipped with the following:

- a digital speedometer (which shows riding speed)
- an odometer (which shows the total distance traveled)
- two tripmeters (which show the distance traveled since they were last set to zero)

- a fuel reserve tripmeter (which shows the distance traveled on the fuel reserve)
- a clock

### NOTE:

For the U.K. only:

To switch the speedometer display between kilometers and miles, press the "SELECT" button and "RESET" button together for at least two seconds.

### Odometer and tripmeter modes

Pushing the "SELECT" button switches the display between the odometer mode "ODO" and the tripmeter modes "TRIP 1" and "TRIP 2" in the following order:

ODO → TRIP 1 → TRIP 2 → ODO

If the fuel level warning light comes on (see page 3-2), the odometer display will automatically change to the fuel reserve tripmeter mode "TRIP F" and start counting the distance traveled from that point. In that case, pushing

the "SELECT" button switches the display between the various tripmeter and odometer modes in the following order: TRIP F → TRIP 1 → TRIP 2 → ODO → TRIP F

To reset a tripmeter, select it by pushing the "SELECT" button, and then push the "RESET" button for at least one second. If you do not reset the fuel reserve tripmeter manually, it will reset itself automatically and the display will return to the prior mode after refueling and traveling 5 km.

### Clock mode

To change the display to the clock mode, push the "SELECT" button for at least one second.

To change the display back to the prior mode, push the "SELECT" button.

# INSTRUMENT AND CONTROL FUNCTIONS

To set the clock:

1. Push the “SELECT” button and “RESET” button together for at least two seconds.
2. When the hour digits start flashing, push the “RESET” button to set the hours.
3. Push the “SELECT” button, and the minute digits will start flashing.
4. Push the “RESET” button to set the minutes.
5. Push the “SELECT” button and then release it to start the clock.

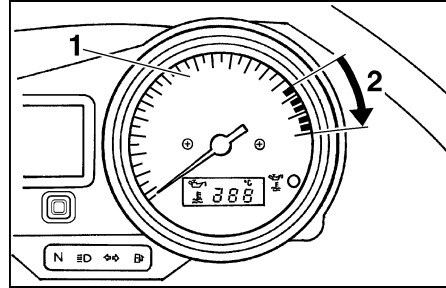

1. Tachometer
2. Tachometer red zone

EAU00101

## Tachometer

The electric tachometer allows the rider to monitor the engine speed and keep it within the ideal power range.

EC000003

### **CAUTION:**

**Do not operate the engine in the tachometer red zone.**

**Red zone: 15,500 r/min and above**

# INSTRUMENT AND CONTROL FUNCTIONS

## Self-diagnosis device

EAU03729

This model is equipped with a self-diagnosis device for the following electrical circuits:

- throttle position sensor
- speed sensor

If any of those circuits are defective, the tachometer will repeatedly display the following error code:

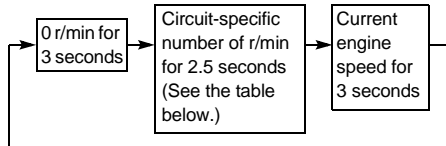

Use the table below to identify the faulty electrical circuit.

| Specific r/min | Faulty electrical circuit |
|----------------|---------------------------|
| 3,000 r/min    | Throttle position sensor  |
| 4,000 r/min    | Speed sensor              |

If the tachometer displays such an error code, note the circuit-specific number of r/min, and then have a Yamaha dealer check the motorcycle.

EC000004

### CAUTION:

**When the tachometer displays an error code, the motorcycle should be checked as soon as possible in order to avoid engine damage.**

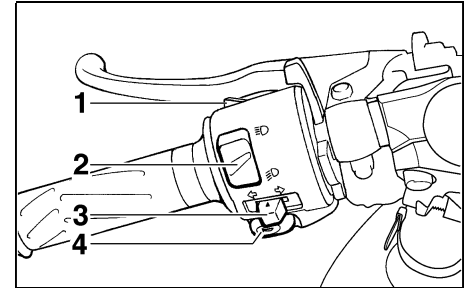

1. Pass switch "PASS"
2. Dimmer switch
3. Turn signal switch
4. Horn switch "📢"

EAU00118

## Handlebar switches

EAU00120

### Pass switch "PASS"

Press this switch to flash the headlight.

EAU00121



### Dimmer switch

Set this switch to "☰" for the high beam and to "☷" for the low beam.

# INSTRUMENT AND CONTROL FUNCTIONS

## Turn signal switch

EAU00127

To signal a right-hand turn, push this switch to “”. To signal a left-hand turn, push this switch to “”. When released, the switch returns to the center position. To cancel the turn signal lights, push the switch in after it has returned to the center position.

## Horn switch “”

EAU00129

Press this switch to sound the horn.

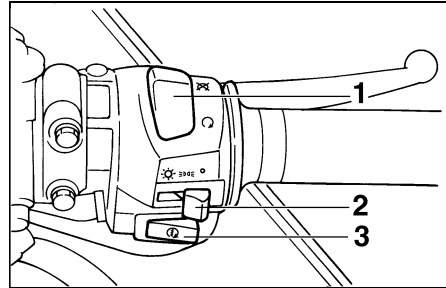

1. Engine stop switch
2. Light switch
3. Start switch “”





## Engine stop switch

EAU00138

Set this switch to “” to stop the engine in case of an emergency, such as when the motorcycle overturns or when the throttle cable is stuck.

## Light switch

EAU01238

Set this switch to “  ” to turn on the auxiliary lights, meter lighting and tail-lights. Set the switch to “” to turn on the headlight also.

## Start switch “”

EAU00143

Push this switch to crank the engine with the starter.

EC000005

### CAUTION:

**See page 5-1 for starting instructions prior to starting the engine.**

# INSTRUMENT AND CONTROL FUNCTIONS

3

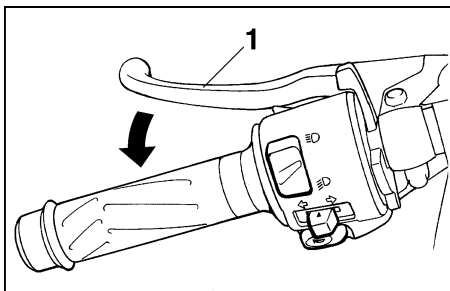

1. Clutch lever

EAU00152

## Clutch lever

The clutch lever is located at the left handlebar grip. To disengage the clutch, pull the lever toward the handlebar grip. To engage the clutch, release the lever. The lever should be pulled rapidly and released slowly for smooth clutch operation.

The clutch lever is equipped with a clutch switch, which is part of the ignition circuit cut-off system. (See page 3-23 for an explanation of the ignition circuit cut-off system.)

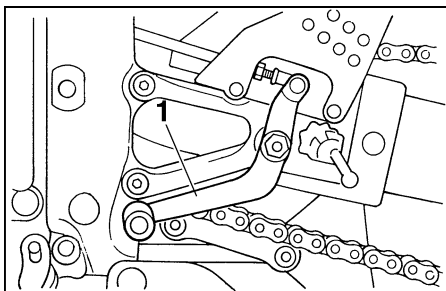

1. Shift pedal

EAU00157

## Shift pedal

The shift pedal is located on the left side of the engine and is used in combination with the clutch lever when shifting the gears of the 6-speed constant-mesh transmission equipped on this motorcycle.

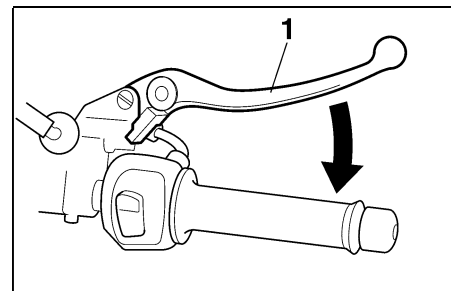

1. Brake lever

EAU00161

## Brake lever

The brake lever is located at the right handlebar grip. To apply the front brake, pull the lever toward the handlebar grip.



# INSTRUMENT AND CONTROL FUNCTIONS

EAU00109

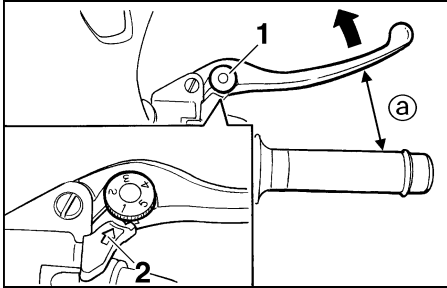

1. Brake lever position adjusting dial
2. Arrow mark
- a. Distance between brake lever and handlebar grip

The brake lever is equipped with a position adjusting dial. To adjust the distance between the brake lever and the handlebar grip, turn the adjusting dial while holding the lever pushed away from the handlebar grip. Make sure that the appropriate setting on the adjusting dial is aligned with the arrow mark on the brake lever.

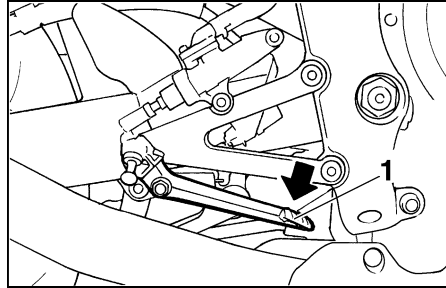

1. Brake pedal

EAU00162

## Brake pedal

The brake pedal is on the right side of the motorcycle. To apply the rear brake, press down on the brake pedal.

## Anti-theft alarm (optional)

This motorcycle can be equipped with an optional anti-theft alarm by a Yamaha dealer. Contact a Yamaha dealer for more information.

# INSTRUMENT AND CONTROL FUNCTIONS

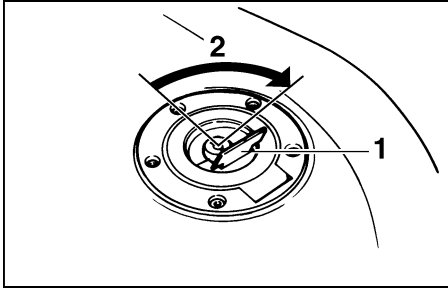

1. Fuel tank cap lock cover
2. Unlock.

EAU02935

## Fuel tank cap

### To open the fuel tank cap

Open the fuel tank cap lock cover, insert the key into the lock, and then turn it 1/4 turn clockwise. The lock will be released and the fuel tank cap can be opened.

### To close the fuel tank cap

1. Push the fuel tank cap into position with the key inserted in the lock.

2. Turn the key counterclockwise to the original position, remove it, and then close the lock cover.

**NOTE:** \_\_\_\_\_  
The fuel tank cap cannot be closed unless the key is in the lock. In addition, the key cannot be removed if the cap is not properly closed and locked.

EWA00025



**WARNING** \_\_\_\_\_

**Make sure that the fuel tank cap is properly closed before riding.**

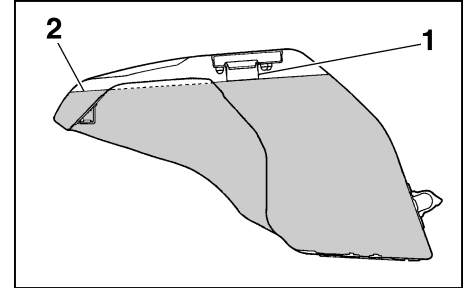

1. Fuel tank filler tube
2. Fuel level

EAU01183

## Fuel

Make sure that there is sufficient fuel in the tank. Fill the fuel tank to the bottom of the filler tube as shown in the illustration.

EW000130



**WARNING** \_\_\_\_\_

- Do not overfill the fuel tank, otherwise it may overflow when the fuel warms up and expands.
- Avoid spilling fuel on the hot engine.

# INSTRUMENT AND CONTROL FUNCTIONS

EAU00185

## CAUTION:

Immediately wipe off spilled fuel with a clean, dry, soft cloth, since fuel may deteriorate painted surfaces or plastic parts.

EAU00191

### Recommended fuel:

Regular unleaded gasoline with a research octane number of 91 or higher

### Fuel tank capacity:

Total amount:  
17 L

Reserve amount:  
3.5 L

## NOTE:

If knocking (or pinging) occurs, use gasoline of a different brand or with a higher octane grade.

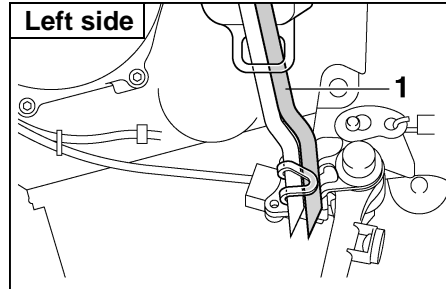

1. Fuel tank breather hose

EAU02955

## Fuel tank breather hose

Before operating the motorcycle:

- Check the fuel tank breather hose connection.
- Check the fuel tank breather hose for cracks or damage, and replace it if damaged.
- Make sure that the end of the fuel tank breather hose is not blocked, and clean it if necessary.

# INSTRUMENT AND CONTROL FUNCTIONS

3

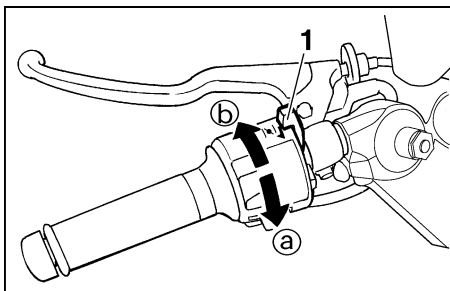

1. Starter (choke) lever

EAU02973

## Starter (choke) lever

Starting a cold engine requires a richer air-fuel mixture, which is supplied by the starter (choke).

Move the lever in direction ① to turn on the starter (choke).

Move the lever in direction ② to turn off the starter (choke).

ECA00038

### CAUTION:

Do not use the starter (choke) for more than 3 minutes as the exhaust pipe may discolor from excessive heat. In addition, extended use of the starter (choke) will cause after-burning. If this occurs, turn off the starter (choke).

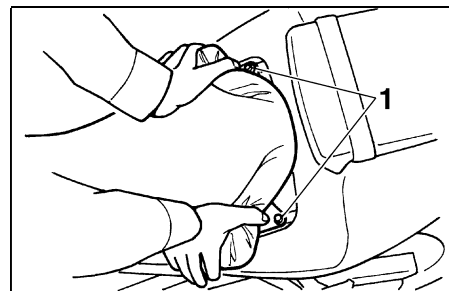

1. Bolt (x 2)

EAU01890

## Seats

### Rider seat

#### To remove the rider seat

Lift up the rear corners of the rider seat as shown, remove the bolts, and then pull the seat off.

# INSTRUMENT AND CONTROL FUNCTIONS

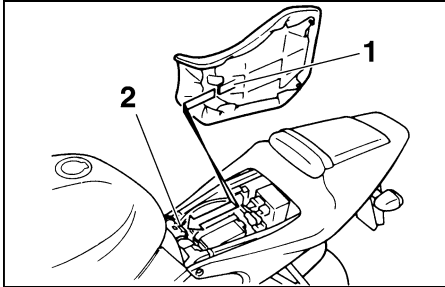

1. Projection
2. Seat holder

## To install the rider seat

Insert the projection on the front of the rider seat into the seat holder as shown, place the seat in the original position, and then install the bolts.

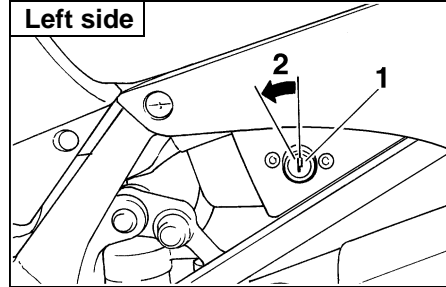

1. Passenger seat lock
2. Unlock.

## Passenger seat

### To remove the passenger seat

1. Insert the key into the seat lock, and then turn it counterclockwise.
2. While holding the key in that position, lift the front of the passenger seat and pull it forward.

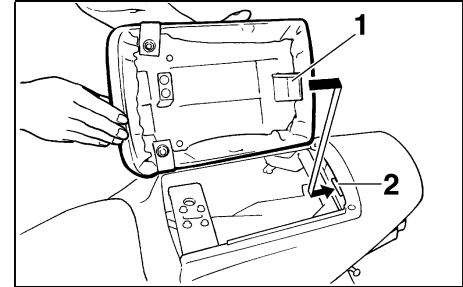

1. Projection
2. Seat holder

### To install the passenger seat

1. Insert the projection on the rear of the passenger seat into the seat holder as shown, and then push the front of the seat down to lock it in place.
2. Remove the key.

**NOTE:** \_\_\_\_\_  
Make sure that the seats are properly secured before riding.

# INSTRUMENT AND CONTROL FUNCTIONS

3

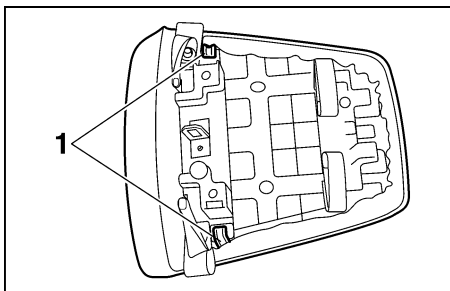

1. Helmet holder (× 2)

EAU03159

## Helmet holders

The helmet holders are located on the bottom of the passenger seat.

### To secure a helmet to a helmet holder

1. Remove the passenger seat. (See page 3-14 for removal and installation procedures.)
2. Attach the helmet to a helmet holder, and then securely install the passenger seat.

EWA00015

### **⚠ WARNING**

Never ride with a helmet attached to a helmet holder, since the helmet may hit objects, causing loss of control and possibly an accident.

### To release the helmet from a helmet holder

Remove the passenger seat, remove the helmet from the helmet holder, and then install the seat.

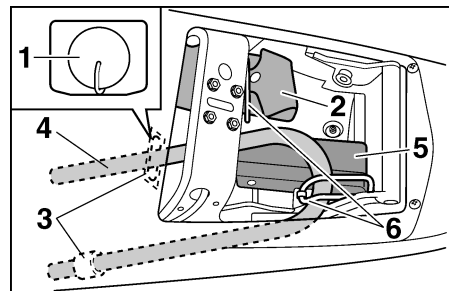

1. Rubber cap
2. Owner's tool kit
3. Hole (× 2)
4. U-LOCK bar (optional)
5. Lock of U-LOCK (optional)
6. Strap (× 2)

EAU03728

## Storage compartment

The storage compartment is located under the passenger seat. (See page 3-14 for passenger seat removal and installation procedures.)

This storage compartment is designed to hold a genuine Yamaha U-LOCK. (Other locks may not fit.)

EWA00005

## **WARNING**

- **Do not exceed the load limit of 3 kg for the storage compartment.**
- **Do not exceed the maximum load of 189 kg for the vehicle.**

To place a U-LOCK in the storage compartment:

1. Remove the rubber cap from the hole at the bottom of the storage compartment, and then store it in a safe place to prevent losing the cap.
2. Insert the ends of the U-LOCK bar into the holes at the bottom of the storage compartment as shown.
3. Place the lock of the U-LOCK under the curved part of the U-LOCK bar as shown.
4. Securely fasten the U-LOCK bar and lock with the strap as shown.

## **NOTE:**

- When the U-LOCK is not in the storage compartment, be sure to cover the hole at the bottom of the storage compartment with the rubber cap.
- When storing items in the storage compartment, be sure to wrap them in a plastic bag to prevent losing them.

# INSTRUMENT AND CONTROL FUNCTIONS

## Adjusting the front fork

This front fork is equipped with spring preload adjusting bolts, rebound damping force adjusting screws and compression damping force adjusting screws.

EAU01862

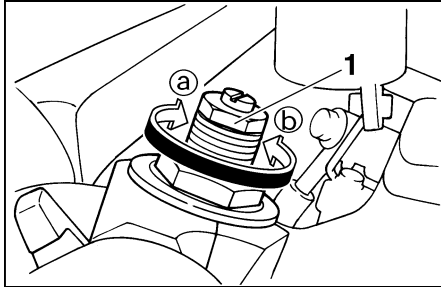

1. Spring preload adjusting bolt

### Spring preload

To increase the spring preload and thereby harden the suspension, turn the adjusting bolt on each fork leg in direction **a**. To decrease the spring preload and thereby soften the suspension, turn the adjusting bolt on each fork leg in direction **b**.

### NOTE:

Align the appropriate groove on the adjusting mechanism with the top of the front fork cap bolt.

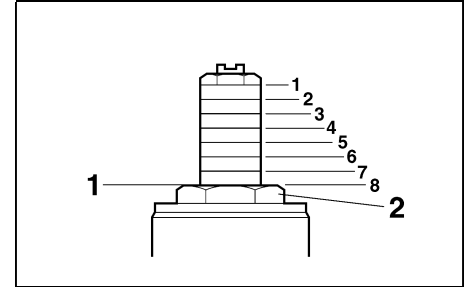

1. Current setting  
2. Front fork cap bolt

|         | Maximum (hard) |   |   |   |   |   |   |   | Standard | Minimum (soft) |
|---------|----------------|---|---|---|---|---|---|---|----------|----------------|
| Setting | 1              | 2 | 3 | 4 | 5 | 6 | 7 | 8 |          |                |

3

### **! WARNING**

**Always adjust both fork legs equally, otherwise poor handling and loss of stability may result.**

EW000035



# INSTRUMENT AND CONTROL FUNCTIONS

EC000015

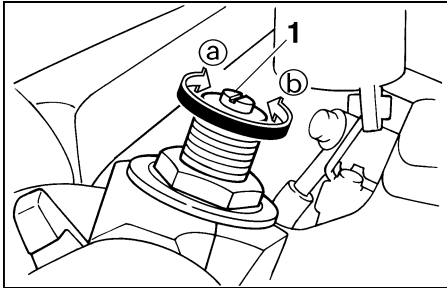

1. Rebound damping force adjusting screw

## Rebound damping force

To increase the rebound damping force and thereby harden the rebound damping, turn the adjusting screw on each fork leg in direction (a). To decrease the rebound damping force and thereby soften the rebound damping, turn the adjusting screw on each fork leg in direction (b).

|                |                            |
|----------------|----------------------------|
| Minimum (soft) | 9 clicks in direction (b)* |
| Standard       | 6 clicks in direction (b)* |
| Maximum (hard) | 1 click in direction (b)*  |

\* With the adjusting screw fully turned in direction (a)

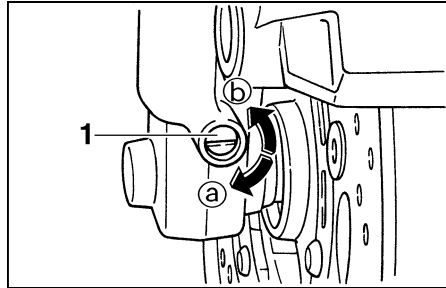

1. Compression damping force adjusting screw

## Compression damping force

To increase the compression damping force and thereby harden the compression damping, turn the adjusting screw on each fork leg in direction (a). To decrease the compression damping force and thereby soften the compression damping, turn the adjusting screw on each fork leg in direction (b).

|                |                             |
|----------------|-----------------------------|
| Minimum (soft) | 10 clicks in direction (b)* |
| Standard       | 6 clicks in direction (b)*  |
| Maximum (hard) | 1 click in direction (b)*   |

\* With the adjusting screw fully turned in direction (a)

## CAUTION:

Never attempt to turn an adjusting mechanism beyond the maximum or minimum settings.

## NOTE:

Although the total number of clicks of a damping force adjusting mechanism may not exactly match the above specifications due to small differences in production, the actual number of clicks always represents the entire adjusting range. To obtain a precise adjustment, it would be advisable to check the number of clicks of each damping force adjusting mechanism and to modify the specifications as necessary.

# INSTRUMENT AND CONTROL FUNCTIONS

EAU01863

## Adjusting the shock absorber assembly

This shock absorber assembly is equipped with a spring preload adjusting ring, a rebound damping force adjusting knob and a compression damping force adjusting screw.

EC000015

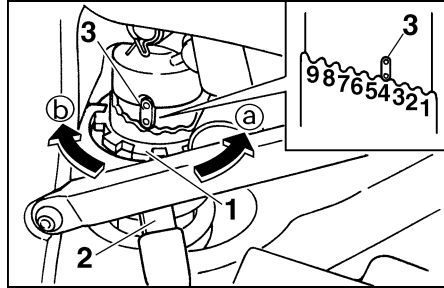

1. Spring preload adjusting ring
2. Special wrench
3. Position indicator

### Spring preload

To increase the spring preload and thereby harden the suspension, turn the adjusting ring in direction (a). To decrease the spring preload and thereby soften the suspension, turn the adjusting ring in direction (b).

### NOTE:

Align the appropriate notch in the adjusting ring with the position indicator on the shock absorber.

|         | Minimum (soft) |   |   | Standard | Maximum (hard) |   |   |   |   |
|---------|----------------|---|---|----------|----------------|---|---|---|---|
| Setting | 1              | 2 | 3 | 4        | 5              | 6 | 7 | 8 | 9 |

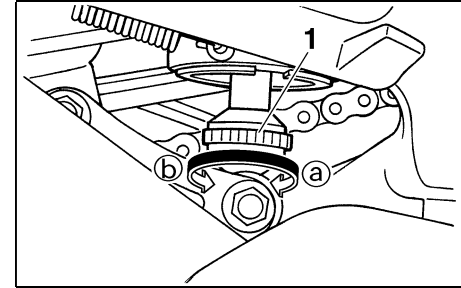

1. Rebound damping force adjusting knob

### Rebound damping force

To increase the rebound damping force and thereby harden the rebound damping, turn the adjusting knob in direction (a). To decrease the rebound damping force and thereby soften the rebound damping, turn the adjusting knob in direction (b).

|                |                             |
|----------------|-----------------------------|
| Minimum (soft) | 20 clicks in direction (b)* |
| Standard       | 9 clicks in direction (b)*  |
| Maximum (hard) | 3 clicks in direction (b)*  |

\* With the adjusting knob fully turned in direction (a)

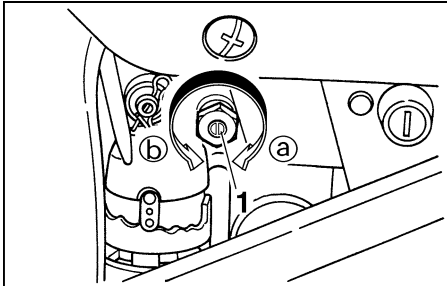

1. Compression damping force adjusting screw

## Compression damping force

To increase the compression damping force and thereby harden the compression damping, turn the adjusting screw in direction ①. To decrease the compression damping force and thereby soften the compression damping, turn the adjusting screw in direction ②.

|                |                           |
|----------------|---------------------------|
| Minimum (soft) | 12 clicks in direction ②* |
| Standard       | 7 clicks in direction ②*  |
| Maximum (hard) | 1 click in direction ②*   |

\* With the adjusting screw fully turned in direction ①

## NOTE:

Although the total number of clicks of a damping force adjusting mechanism may not exactly match the above specifications due to small differences in production, the actual number of clicks always represents the entire adjusting range. To obtain a precise adjustment, it would be advisable to check the number of clicks of each damping force adjusting mechanism and to modify the specifications as necessary.

## ⚠ WARNING

This shock absorber contains highly pressurized nitrogen gas. For proper handling, read and understand the following information before handling the shock absorber. The manufacturer cannot be held responsible for property damage or personal injury that may result from improper handling.

- Do not tamper with or attempt to open the gas cylinder.
- Do not subject the shock absorber to an open flame or other high heat sources, otherwise it may explode due to excessive gas pressure.
- Do not deform or damage the gas cylinder in any way, as this will result in poor damping performance.
- Always have a Yamaha dealer service the shock absorber.

# INSTRUMENT AND CONTROL FUNCTIONS

EAU01580

## Matching the front and rear suspension settings

Use this table as a guide to match the suspension and damping adjustments of the front fork and shock absorber assembly according to various load conditions.

| Load condition | Front fork adjustment |                           |                       | Shock absorber assembly adjustment |                           |                       |
|----------------|-----------------------|---------------------------|-----------------------|------------------------------------|---------------------------|-----------------------|
|                | Spring preload        | Compression damping force | Rebound damping force | Spring preload                     | Compression damping force | Rebound damping force |
| Rider only     | 1–8                   | 1–10                      | 1–9                   | 1–7                                | 4–12                      | 3–20                  |
| With passenger | 1–8                   | 1–10                      | 1–9                   | 4–9                                | 1–8                       | 3–7                   |

EC000015

### CAUTION:

**Never attempt to turn an adjusting mechanism beyond the maximum or minimum settings.**

EAU00330

EW000044

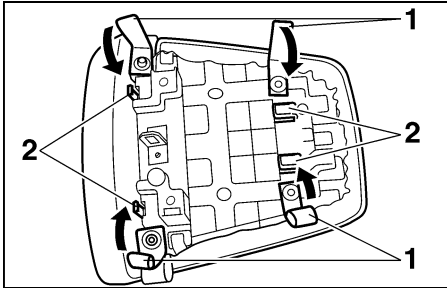

1. Luggage strap holder (× 4)
2. Hook (× 4)

EAU03170

## Luggage strap holders

There are four luggage strap holders on the bottom of the passenger seat. To use the strap holders, remove the passenger seat, unhook the straps, and then install the seat with the straps hanging out from under the passenger seat. (See page 3-14 for passenger seat removal and installation procedures.)

## Sidestand

The sidestand is located on the left side of the frame. Raise the sidestand or lower it with your foot while holding the motorcycle upright.

### NOTE:

The built-in sidestand switch is part of the ignition circuit cut-off system, which cuts the ignition in certain situations. (See further down for an explanation of the ignition circuit cut-off system.)

### **! WARNING**

The motorcycle must not be ridden with the sidestand down, or if the sidestand cannot be properly moved up (or does not stay up), otherwise the sidestand could contact the ground and distract the operator, resulting in a possible loss of control. Yamaha's ignition circuit cut-off system has been designed to assist the operator in fulfilling the responsibility of raising the sidestand before starting off. Therefore, check this system regularly as described below and have a Yamaha dealer repair it if it does not function properly.

# INSTRUMENT AND CONTROL FUNCTIONS

---

---

EAU03720

## Ignition circuit cut-off system

The ignition circuit cut-off system (comprising the sidestand switch, clutch switch and neutral switch) has the following functions.

- It prevents starting when the transmission is in gear and the sidestand is up, but the clutch lever is not pulled.
- It prevents starting when the transmission is in gear and the clutch lever is pulled, but the sidestand is still down.
- It cuts the running engine when the transmission is in gear and the sidestand is moved down.

Periodically check the operation of the ignition circuit cut-off system according to the following procedure.

EW000045

### **WARNING**

**If a malfunction is noted, have a Yamaha dealer check the system before riding.**

---

# INSTRUMENT AND CONTROL FUNCTIONS

With the engine turned off:  
1. Move the sidestand down.  
2. Make sure that the engine stop switch is set to “○”.  
3. Turn the key to “ON”.  
4. Shift the transmission into the neutral position.  
5. Push the start switch.  
**Does the engine start?**

YES NO

With the engine still running:  
6. Move the sidestand up.  
7. Keep the clutch lever pulled.  
8. Shift the transmission into gear.  
9. Move the sidestand down.  
**Does the engine stall?**

YES NO

After the engine has stalled:  
10. Move the sidestand up.  
11. Keep the clutch lever pulled.  
12. Push the start switch.  
**Does the engine start?**

YES NO

The system is OK. **The motorcycle can be ridden.**

**NOTE:** \_\_\_\_\_  
This check is most reliable if performed with a warmed-up engine.  
\_\_\_\_\_

The neutral switch may be defective.  
**The motorcycle should not be ridden** until checked by a Yamaha dealer.

The sidestand switch may be defective.  
**The motorcycle should not be ridden** until checked by a Yamaha dealer.

The clutch switch may be defective.  
**The motorcycle should not be ridden** until checked by a Yamaha dealer.





Pre-operation check list ..... 4-1

# PRE-OPERATION CHECKS

The condition of a vehicle is the owner's responsibility. Vital components can start to deteriorate quickly and unexpectedly, even if the vehicle remains unused (for example, as a result of exposure to the elements). Any damage, fluid leakage or loss of tire air pressure could have serious consequences. Therefore, it is very important, in addition to a thorough visual inspection, to check the following points before each ride.

## Pre-operation check list

| ITEM               | CHECKS   | PAGE            |
|--------------------|--|-----------------|
| <b>Fuel</b>        | <ul style="list-style-type: none"><li>• Check fuel level in fuel tank.</li><li>• Refuel if necessary.</li><li>• Check fuel line for leakage.</li></ul>   | 3-11–3-12       |
| <b>Engine oil</b>  | <ul style="list-style-type: none"><li>• Check oil level in engine.</li><li>• If necessary, add recommended oil to specified level.</li><li>• Check vehicle for oil leakage.</li></ul>  | 6-10–6-13       |
| <b>Coolant</b>     | <ul style="list-style-type: none"><li>• Check coolant level in reservoir.</li><li>• If necessary, add recommended coolant to specified level.</li><li>• Check cooling system for leakage.</li></ul>  | 6-13–6-17       |
| <b>Front brake</b> | <ul style="list-style-type: none"><li>• Check operation.</li><li>• If soft or spongy, have Yamaha dealer bleed hydraulic system.</li><li>• Check fluid level in reservoir.</li><li>• If necessary, add recommended brake fluid to specified level.</li><li>• Check hydraulic system for leakage.</li></ul> | 6-28–6-30       |
| <b>Rear brake</b>  | <ul style="list-style-type: none"><li>• Check operation.</li><li>• If soft or spongy, have Yamaha dealer bleed hydraulic system.</li><li>• Check fluid level in reservoir.</li><li>• If necessary, add recommended brake fluid to specified level.</li><li>• Check hydraulic system for leakage.</li></ul> | 6-27–6-30       |
| <b>Clutch</b>      | <ul style="list-style-type: none"><li>• Check operation.</li><li>• Lubricate cable if necessary.</li><li>• Check lever free play.</li><li>• Adjust if necessary.</li></ul>   | 6-25–6-26, 6-34 |

4

# PRE-OPERATION CHECKS

| ITEM   | CHECKS  | PAGE       |
|--|---|------------|
| <b>Throttle grip</b>                             | <ul style="list-style-type: none"> <li>• Make sure that operation is smooth.</li> <li>• Lubricate throttle grip, housing and cables if necessary.</li> <li>• Check free play.</li> <li>• If necessary, have Yamaha dealer make adjustment.</li> </ul> | 6-21, 6-33 |
| <b>Control cables</b>                            | <ul style="list-style-type: none"> <li>• Make sure that operation is smooth.</li> <li>• Lubricate if necessary.</li> </ul>  | 6-33       |
| <b>Drive chain</b>                               | <ul style="list-style-type: none"> <li>• Check chain slack.</li> <li>• Adjust if necessary.</li> <li>• Check chain condition.</li> <li>• Lubricate if necessary.</li> </ul>   | 6-31–6-32  |
| <b>Wheels and tires</b>                          | <ul style="list-style-type: none"> <li>• Check for damage.</li> <li>• Check tire condition and tread depth.</li> <li>• Check air pressure.</li> <li>• Correct if necessary.</li> </ul>  | 6-22–6-25  |
| <b>Brake and shift pedals</b>                    | <ul style="list-style-type: none"> <li>• Make sure that operation is smooth.</li> <li>• Lubricate pedal pivoting points if necessary.</li> </ul>  | 6-34       |
| <b>Brake and clutch levers</b>                   | <ul style="list-style-type: none"> <li>• Make sure that operation is smooth.</li> <li>• Lubricate lever pivoting points if necessary.</li> </ul>  | 6-34       |
| <b>Sidestand</b>                                 | <ul style="list-style-type: none"> <li>• Make sure that operation is smooth.</li> <li>• Lubricate pivot if necessary.</li> </ul>  | 6-34       |
| <b>Chassis fasteners</b>                         | <ul style="list-style-type: none"> <li>• Make sure that all nuts, bolts and screws are properly tightened.</li> <li>• Tighten if necessary.</li> </ul>  | —          |
| <b>Instruments, lights, signals and switches</b> | <ul style="list-style-type: none"> <li>• Check operation.</li> <li>• Correct if necessary.</li> </ul>   | —          |
| <b>Engine stop switch</b>                        | <ul style="list-style-type: none"> <li>• Check operation.</li> </ul>  | 3-8        |
| <b>Sidestand switch</b>                          | <ul style="list-style-type: none"> <li>• Check operation of ignition circuit cut-off system.</li> <li>• If system is defective, have Yamaha dealer check vehicle.</li> </ul>  | 3-22       |

# PRE-OPERATION CHECKS

---

---

**NOTE:**

Pre-operation checks should be made each time the motorcycle is used. Such an inspection can be accomplished in a very short time; and the added safety it assures is more than worth the time involved.

---

EWA00033

**⚠ WARNING**

**If any item in the Pre-operation check list is not working properly, have it inspected and repaired before operating the motorcycle.**

---

# OPERATION AND IMPORTANT RIDING POINTS

---

|  |     |
|--|-----|
| Starting a cold engine .....             | 5-1 |
| Starting a warm engine .....             | 5-2 |
| Shifting .....                           | 5-3 |
| Tips for reducing fuel consumption ..... | 5-3 |
| Engine break-in .....                    | 5-4 |
| Parking .....                            | 5-4 |

EAU00373

EAU01382\*

ECA00005

**⚠ WARNING**

- Become thoroughly familiar with all operating controls and their functions before riding. Consult a Yamaha dealer regarding any control or function that you do not thoroughly understand.
- Never start the engine or operate it in a closed area for any length of time. Exhaust fumes are poisonous, and inhaling them can cause loss of consciousness and death within a short time. Always make sure that there is adequate ventilation.
- Before starting out, make sure that the sidestand is up. If the sidestand is not raised completely, it could contact the ground and distract the operator, resulting in a possible loss of control.

## Starting a cold engine

In order for the ignition circuit cut-off system to enable starting, one of the following conditions must be met:

- The transmission is in the neutral position.
- The transmission is in gear with the clutch lever pulled and the sidestand up.

EW000054

**⚠ WARNING**

- Before starting the engine, check the function of the ignition circuit cut-off system according to the procedure described on page 3-24.
- Never ride with the sidestand down.

1. Turn the key to "ON" and make sure that the engine stop switch is set to "⊙".

**CAUTION:**

The oil level/coolant temperature warning light and fuel level warning light should come on for a few seconds, then go off. If a warning light does not go off, see page 3-4 for the corresponding warning light circuit check.

2. Shift the transmission into the neutral position.

**NOTE:**

When the transmission is in the neutral position, the neutral indicator light should be on, otherwise have a Yamaha dealer check the electrical circuit.

3. Turn the starter (choke) on and completely close the throttle. (See page 3-13 for starter (choke) operation.)
4. Start the engine by pushing the start switch.

---

---

# OPERATION AND IMPORTANT RIDING POINTS

---

---

**NOTE:** \_\_\_\_\_

If the engine fails to start, release the start switch, wait a few seconds, and then try again. Each starting attempt should be as short as possible to preserve the battery. Do not crank the engine more than 10 seconds on any one attempt.

5. After starting the engine, move the starter (choke) lever back halfway.

ECA00045

**CAUTION:** \_\_\_\_\_

**For maximum engine life, never accelerate hard when the engine is cold!**

6. When the engine is warm, turn the starter (choke) off.

**NOTE:** \_\_\_\_\_

The engine is warm when it responds normally to the throttle with the starter (choke) turned off.

EAU01258

## Starting a warm engine

Follow the same procedure as for starting a cold engine with the exception that the starter (choke) is not required when the engine is warm.

# OPERATION AND IMPORTANT RIDING POINTS

EC000048

EAU00424

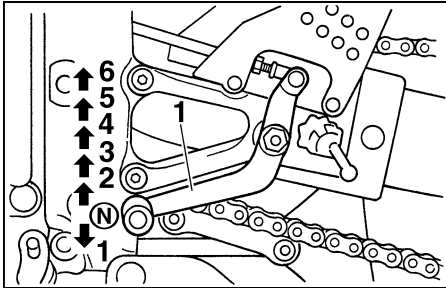

1. Shift pedal  
N. Neutral position

EAU00423

5

## Shifting

Shifting gears lets you control the amount of engine power available for starting off, accelerating, climbing hills, etc.

The gear positions are shown in the illustration.

### NOTE:

To shift the transmission into the neutral position, press the shift pedal down repeatedly until it reaches the end of its travel, and then slightly raise it.

### CAUTION:

- Even with the transmission in the neutral position, do not coast for long periods of time with the engine off, and do not tow the motorcycle for long distances. The transmission is properly lubricated only when the engine is running. Inadequate lubrication may damage the transmission.
- Always use the clutch while changing gears to avoid damaging the engine, transmission, and drive train, which are not designed to withstand the shock of forced shifting.

## Tips for reducing fuel consumption

Fuel consumption depends largely on your riding style. Consider the following tips to reduce fuel consumption:

- Thoroughly warm up the engine.
- Turn the starter (choke) off as soon as possible.
- Shift up swiftly, and avoid high engine speeds during acceleration.
- Do not rev the engine while shifting down, and avoid high engine speeds with no load on the engine.
- Turn the engine off instead of letting it idle for an extended length of time (e.g., in traffic jams, at traffic lights or at railroad crossings).



---

---

# OPERATION AND IMPORTANT RIDING POINTS

---

---

## Engine break-in

EAU01128

There is never a more important period in the life of your engine than the period between 0 and 1,600 km. For this reason, you should read the following material carefully.

Since the engine is brand new, do not put an excessive load on it for the first 1,600 km. The various parts in the engine wear and polish themselves to the correct operating clearances. During this period, prolonged full-throttle operation or any condition that might result in engine overheating must be avoided.

### 0–1,000 km

EAU01329\*

Avoid prolonged operation above 5,000 r/min.

### 1,000–1,600 km

Avoid prolonged operation above 6,000 r/min.

EC000052\*

#### **CAUTION:** \_\_\_\_\_

**After 1,000 km of operation, the engine oil must be changed and the oil filter cartridge replaced.**

---

### 1,600 km and beyond

The vehicle can now be operated normally.

EC000053

#### **CAUTION:** \_\_\_\_\_

- Keep the engine speed out of the tachometer red zone.
  - If any engine trouble should occur during the engine break-in period, immediately have a Yamaha dealer check the vehicle.
- 

## Parking

EAU00460

When parking, stop the engine, and then remove the key from the main switch.

EW000058

#### **⚠ WARNING** \_\_\_\_\_

- Since the engine and exhaust system can become very hot, park in a place where pedestrians or children are not likely to touch them.
  - Do not park on a slope or on soft ground, otherwise the motorcycle may overturn.
-



# PERIODIC MAINTENANCE AND MINOR REPAIR

|   |      |   |      |
|---|------|---|------|
| Owner's tool kit .....                            | 6-1  | Lubricating the drive chain .....                             | 6-32 |
| Periodic maintenance and lubrication chart .....  | 6-3  | Checking and lubricating the cables .....                     | 6-33 |
| Removing and installing cowlings and panels ..... | 6-6  | Checking and lubricating the throttle<br>grip and cable ..... | 6-33 |
| Cowlings A and B .....                            | 6-6  | Lubricating the brake pedal .....                             | 6-34 |
| Checking the spark plugs .....                    | 6-9  | Checking and lubricating the brake and<br>clutch levers ..... | 6-34 |
| Engine oil and oil filter cartridge .....         | 6-10 | Checking and lubricating the sidestand .....                  | 6-34 |
| Coolant .....                                     | 6-13 | Lubricating the rear suspension .....                         | 6-35 |
| Checking the air filter element .....             | 6-17 | Checking the front fork .....                                 | 6-35 |
| Air intake duct .....                             | 6-20 | Checking the steering .....                                   | 6-36 |
| Adjusting the carburetors .....                   | 6-20 | Checking the wheel bearings .....                             | 6-36 |
| Adjusting the engine idling speed .....           | 6-21 | Battery .....   | 6-37 |
| Adjusting the throttle cable free play .....      | 6-21 | Replacing the fuses .....                                     | 6-38 |
| Adjusting the valve clearance .....               | 6-22 | Replacing the headlight bulb .....                            | 6-39 |
| Tires .....                                       | 6-22 | Tail/brake light .....  | 6-40 |
| Wheels .....                                      | 6-25 | Replacing a turn signal light bulb .....                      | 6-40 |
| Adjusting the clutch lever free play .....        | 6-25 | Supporting the motorcycle .....                               | 6-41 |
| Adjusting the brake pedal position .....          | 6-27 | Front wheel .....   | 6-41 |
| Adjusting the rear brake light switch .....       | 6-27 | Rear wheel .....  | 6-43 |
| Checking the front and rear brake pads .....      | 6-28 | Troubleshooting .....   | 6-44 |
| Checking the brake fluid level .....              | 6-29 | Troubleshooting charts .....                                  | 6-45 |
| Changing the brake fluid .....                    | 6-30 |   |      |
| Drive chain slack .....                           | 6-31 |   |      |

Safety is an obligation of the owner. Periodic inspection, adjustment and lubrication will keep your vehicle in the safest and most efficient condition possible. The most important points of inspection, adjustment, and lubrication are explained on the following pages.

EAU00464

The intervals given in the periodic maintenance and lubrication chart should be simply considered as a general guide under normal riding conditions. However, DEPENDING ON THE WEATHER, TERRAIN, GEOGRAPHICAL LOCATION, AND INDIVIDUAL USE, THE MAINTENANCE INTERVALS MAY NEED TO BE SHORTENED.

EW000060

## WARNING

**If you are not familiar with motorcycle maintenance work, have a Yamaha dealer do it for you.**

EAU01296

## CAUTION:

**Do not test this motorcycle on a dynamometer stand for an extended period of time, otherwise heat-induced discoloration of the fiber-constructed muffler may occur.**

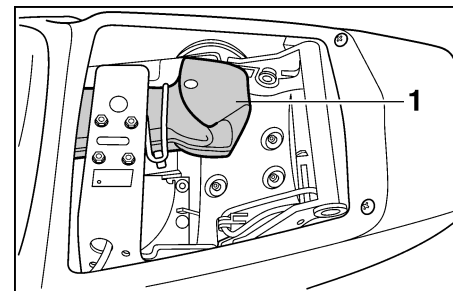

1. Owner's tool kit

EAU01129

## Owner's tool kit

The owner's tool kit is located inside the storage compartment. (See page 3-15 for storage compartment opening procedures.)

The service information included in this manual and the tools provided in the owner's tool kit are intended to assist you in the performance of preventive maintenance and minor repairs. However, additional tools such as a torque wrench may be necessary to perform certain maintenance work correctly.

# PERIODIC MAINTENANCE AND MINOR REPAIR

---

---

**NOTE:** \_\_\_\_\_

If you do not have the tools or experience required for a particular job, have a Yamaha dealer perform it for you.

---

EW000063

 **WARNING** \_\_\_\_\_

**Modifications not approved by Yamaha may cause loss of performance and render the vehicle unsafe for use. Consult a Yamaha dealer before attempting any changes.**

---

# PERIODIC MAINTENANCE AND MINOR REPAIR

EAU03685

## Periodic maintenance and lubrication chart

### NOTE:

- The annual checks must be performed every year, except if a kilometer-based maintenance is performed instead.
- From 50,000 km, repeat the maintenance intervals starting from 10,000 km.
- Items marked with an asterisk should be performed by a Yamaha dealer as they require special tools, data and technical skills.

| NO. | ITEM               | CHECK OR MAINTENANCE JOB   | ODOMETER READING (× 1,000 km) |    |    |    |    | ANNUAL CHECK |
|-----|--------------------|--|-------------------------------|----|----|----|----|--------------|
|     |                    |  | 1                             | 10 | 20 | 30 | 40 |              |
| 1   | * Fuel line        | • Check fuel hoses for cracks or damage.   |                               | √  | √  | √  | √  | √            |
| 2   | * Fuel filter      | • Check condition.   |                               |    | √  |    | √  |              |
| 3   | Spark plugs        | • Check condition.<br>• Clean and regap.   |                               | √  |    | √  |    |              |
|     |                    | • Replace.   |                               |    | √  |    | √  |              |
| 4   | * Valves           | • Check valve clearance.<br>• Adjust.  | Every 40,000 km               |    |    |    |    |              |
| 5   | Air filter element | • Clean.   |                               | √  |    | √  |    |              |
|     |                    | • Replace.   |                               |    | √  |    | √  |              |
| 6   | Clutch             | • Check operation.<br>• Adjust.  | √                             | √  | √  | √  | √  |              |
| 7   | * Front brake      | • Check operation, fluid level and vehicle for fluid leakage.<br>(See NOTE on page 6-5.) | √                             | √  | √  | √  | √  | √            |
|     |                    | • Replace brake pads.  | Whenever worn to the limit    |    |    |    |    |              |
| 8   | * Rear brake       | • Check operation, fluid level and vehicle for fluid leakage.<br>(See NOTE on page 6-5.) | √                             | √  | √  | √  | √  | √            |
|     |                    | • Replace brake pads.  | Whenever worn to the limit    |    |    |    |    |              |

# PERIODIC MAINTENANCE AND MINOR REPAIR

| NO. | ITEM | CHECK OR MAINTENANCE JOB   | ODOMETER READING (× 1,000 km)  |    |    |    |    | ANNUAL CHECK |
|-----|------|--|--|----|----|----|----|--------------|
|     |      |  | 1  | 10 | 20 | 30 | 40 |              |
| 9   | *    | <b>Brake hoses</b><br>• Check for cracks or damage.<br>• Replace. (See NOTE on page 6-5.)  |  | √  | √  | √  | √  | √            |
|     |      |  | Every 4 years  |    |    |    |    |              |
| 10  | *    | <b>Wheels</b><br>• Check runout and for damage.  |  | √  | √  | √  | √  |              |
| 11  | *    | <b>Tires</b><br>• Check tread depth and for damage.<br>• Replace if necessary.<br>• Check air pressure.<br>• Correct if necessary.       |  | √  | √  | √  | √  |              |
|     |      |  |  |    |    |    |    |              |
| 12  | *    | <b>Wheel bearings</b><br>• Check bearing for looseness or damage.  |  | √  | √  | √  | √  |              |
| 13  | *    | <b>Swingarm</b><br>• Operation and for excessive play.<br>• Lubricate with lithium-soap-based grease.                                    |  | √  | √  | √  | √  |              |
|     |      |  | Every 50,000 km  |    |    |    |    |              |
| 14  |      | <b>Drive chain</b><br>• Check chain slack.<br>• Make sure that the rear wheel is properly aligned.<br>• Clean and lubricate.             | Every 1,000 km and after washing the motorcycle or riding in the rain. |    |    |    |    |              |
| 15  | *    | <b>Steering bearings</b><br>• Check bearing play and steering for roughness.<br>• Lubricate with lithium-soap-based grease.              | √  | √  | √  | √  | √  |              |
|     |      |  | Every 20,000 km  |    |    |    |    |              |
| 16  | *    | <b>Chassis fasteners</b><br>• Make sure that all nuts, bolts and screws are properly tightened.  |  | √  | √  | √  | √  | √            |
| 17  |      | <b>Sidestand</b><br>• Check operation.<br>• Lubricate.   |  | √  | √  | √  | √  | √            |
| 18  | *    | <b>Sidestand switch</b><br>• Check operation.  | √  | √  | √  | √  | √  | √            |
| 19  | *    | <b>Front fork</b><br>• Check operation and for oil leakage.  |  | √  | √  | √  | √  |              |
| 20  | *    | <b>Rear shock absorber assembly</b><br>• Check operation and shock absorber for oil leakage.   |  | √  | √  | √  | √  |              |
| 21  | *    | <b>Rear suspension relay arm and connecting arm pivoting points</b><br>• Check operation.<br>• Lubricate with lithium-soap-based grease. |  | √  | √  | √  | √  |              |
|     |      |  |  |    | √  |    | √  |              |

# PERIODIC MAINTENANCE AND MINOR REPAIR

| NO. | ITEM                            | CHECK OR MAINTENANCE JOB  | ODOMETER READING (× 1,000 km) |    |    |    |    | ANNUAL CHECK |
|-----|---------------------------------|---|-------------------------------|----|----|----|----|--------------|
|     |                                 |   | 1                             | 10 | 20 | 30 | 40 |              |
| 22  | * Carburetors                   | <ul style="list-style-type: none"> <li>• Check starter (choke) operation.</li> <li>• Adjust engine idling speed and synchronization.</li> </ul> | √                             | √  | √  | √  | √  | √            |
| 23  | Engine oil                      | <ul style="list-style-type: none"> <li>• Change.</li> </ul>   | √                             | √  | √  | √  | √  | √            |
| 24  | Engine oil filter cartridge     | <ul style="list-style-type: none"> <li>• Replace.</li> </ul>  | √                             |    | √  |    | √  |              |
| 25  | * Cooling system                | <ul style="list-style-type: none"> <li>• Check coolant level and vehicle for coolant leakage.</li> </ul>  |                               | √  | √  | √  | √  | √            |
|     |                                 | <ul style="list-style-type: none"> <li>• Change.</li> </ul>   | Every 3 years                 |    |    |    |    |              |
| 26  | * Front and rear brake switches | <ul style="list-style-type: none"> <li>• Check operation.</li> </ul>  | √                             | √  | √  | √  | √  | √            |
| 27  | Moving parts and cables         | <ul style="list-style-type: none"> <li>• Lubricate.</li> </ul>  |                               | √  | √  | √  | √  | √            |
| 28  | * Lights, signals and switches  | <ul style="list-style-type: none"> <li>• Check operation.</li> <li>• Adjust headlight beam.</li> </ul>  | √                             | √  | √  | √  | √  | √            |

EAU03541

6

## NOTE:

- The air filter needs more frequent service if you are riding in unusually wet or dusty areas.
- Hydraulic brake service
  - Regularly check and, if necessary, correct the brake fluid level.
  - Every two years replace the internal components of the brake master cylinder and caliper, and change the brake fluid.
  - Replace the brake hoses every four years and if cracked or damaged.



# PERIODIC MAINTENANCE AND MINOR REPAIR

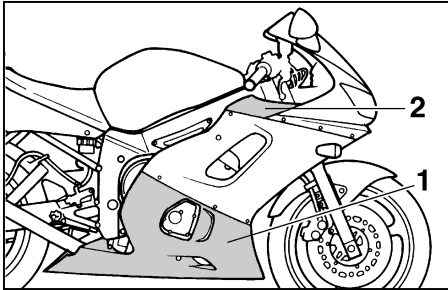

1. Cowling A (right side)  
Cowling B (left side)
2. Panel C

EAU01139

## Removing and installing cowlings and panels

The cowlings and panels shown above need to be removed to perform some of the maintenance jobs described in this chapter. Refer to this section each time a cowling or panel needs to be removed and installed.

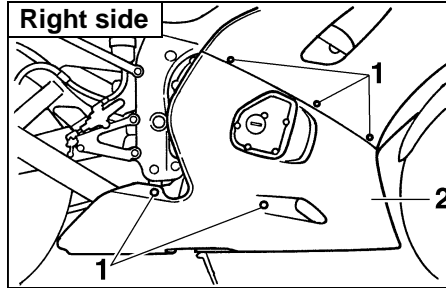

1. Screw (× 5)
2. Cowling A

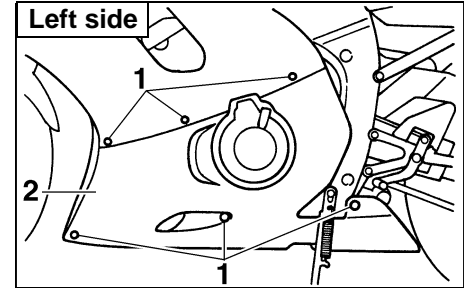

1. Screw (× 6)
2. Cowling B

EAU01602

## Cowlings A and B

### To remove one of the cowlings

Remove the screws, slide the cowling forward (for A) or backward (for B), and then pull it off as shown.

# PERIODIC MAINTENANCE AND MINOR REPAIR

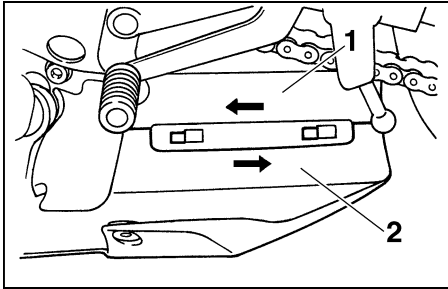

1. Cowling A
2. Cowling B

## To install the cowling

1. Fit the slots and projections at the rear bottom of each cowling together, and then slide the cowling into place.

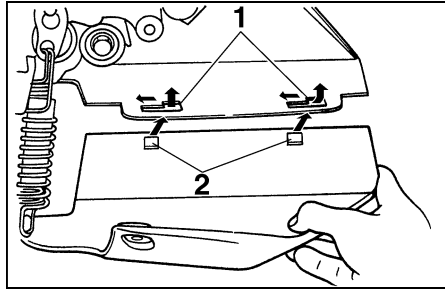

1. Slot (× 2)
2. Projection (× 2)

2. Place the cowling in the original position, and then install the screws.

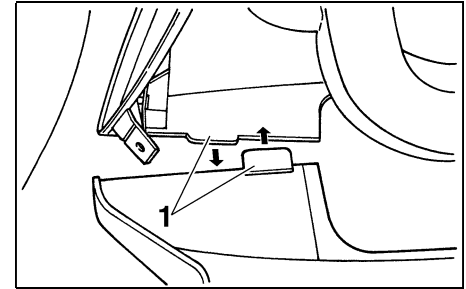

1. Tab (× 2)

## **NOTE:**

Make sure that the tabs at the front of each cowling fit side by side as shown and that all slots and projections fit together.

# PERIODIC MAINTENANCE AND MINOR REPAIR

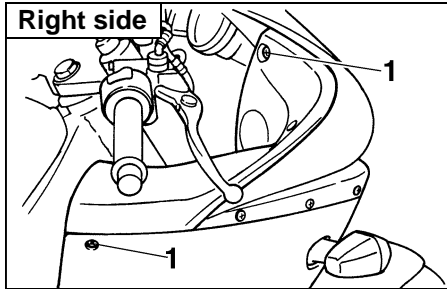

1. Screw (x 2)

EAU01315

## Panel C

### To remove the panel

Remove the screws, and then take the panel off.

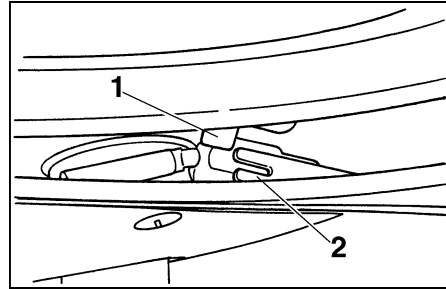

1. Projection
2. Slot

### To install the panel

Place the panel in the original position, and then install the screws.

# PERIODIC MAINTENANCE AND MINOR REPAIR

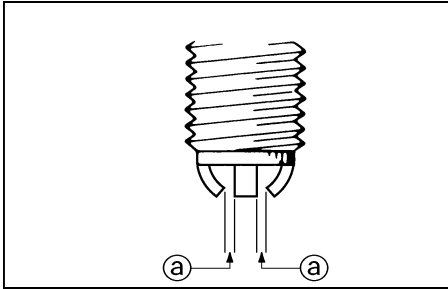

a. Spark plug gap

EAU01639

## Checking the spark plugs

The spark plugs are important engine components, which should be checked periodically, preferably by a Yamaha dealer. Since heat and deposits will cause any spark plug to slowly erode, they should be removed and checked in accordance with the periodic maintenance and lubrication chart. In addition, the condition of the spark plugs can reveal the condition of the engine.

The porcelain insulator around the center electrode of each spark plug should be a medium-to-light tan (the ideal color when the motorcycle is ridden normally), and all spark plugs installed in the engine should have the same color. If any spark plug shows a distinctly different color, the engine could be defective. Do not attempt to diagnose such problems yourself. Instead, have a Yamaha dealer check the motorcycle. If a spark plug shows signs of electrode erosion and excessive carbon or other deposits, it should be replaced.

Specified spark plug:  
CR10EK (NGK)

Before installing a spark plug, the spark plug gap should be measured with a wire thickness gauge and, if necessary, adjusted to specification.

Spark plug gap:  
0.6–0.7 mm

Clean the surface of the spark plug gasket and its mating surface, and then wipe off any grime from the spark plug threads.

Tightening torque:  
Spark plug:  
12.5 Nm (1.25 m·kg)

**NOTE:** \_\_\_\_\_  
If a torque wrench is not available when installing a spark plug, a good estimate of the correct torque is 1/4–1/2 turn past finger tight. However, the spark plug should be tightened to the specified torque as soon as possible.  
\_\_\_\_\_

# PERIODIC MAINTENANCE AND MINOR REPAIR

ECA00021

EAU01610

## **CAUTION:**

Do not use any tools to remove or install the spark plug cap, otherwise the ignition coil coupler may get damaged. The spark plug cap may be difficult to remove because the rubber seal on the end of the cap fits tightly. To remove the spark plug cap, simply twist it back and forth while pulling it out; to install it, twist it back and forth while pushing it in.

## **Engine oil and oil filter cartridge**

The engine oil level should be checked before each ride. In addition, the oil must be changed and the oil filter cartridge replaced at the intervals specified in the periodic maintenance and lubrication chart.

### **To check the engine oil level**

1. Place the motorcycle on a level surface and hold it in an upright position.

### **NOTE:**

Make sure that the motorcycle is positioned straight up when checking the oil level. A slight tilt to the side can result in a false reading.

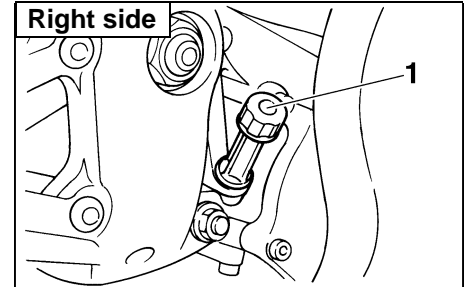

1. Engine oil dipstick

2. Start the engine, warm it up for several minutes, and then turn it off.
3. Wait a few minutes until the oil settles, remove the oil filler cap, wipe the dipstick clean, insert it back into the oil filler hole (without screwing it in), and then remove it again to check the oil level.

# PERIODIC MAINTENANCE AND MINOR REPAIR

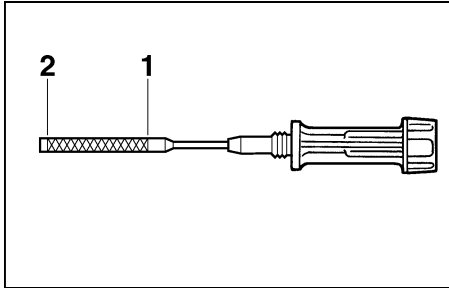

1. Maximum level mark
2. Minimum level mark

**NOTE:** \_\_\_\_\_  
The engine oil should be between the minimum and maximum level marks.

4. If the engine oil is below the minimum level mark, add sufficient oil of the recommended type to raise it to the correct level.
5. Insert the dipstick into the oil filler hole, and then tighten the oil filler cap.

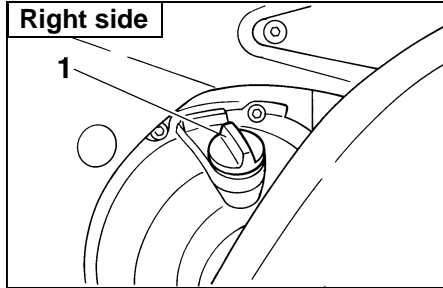

1. Engine oil filler cap

**To change the engine oil (with or without oil filter cartridge replacement)**

1. Remove cowling A and B. (See page 6-6 for cowling removal and installation procedures.)
2. Start the engine, warm it up for several minutes, and then turn it off.
3. Place an oil pan under the engine to collect the used oil.

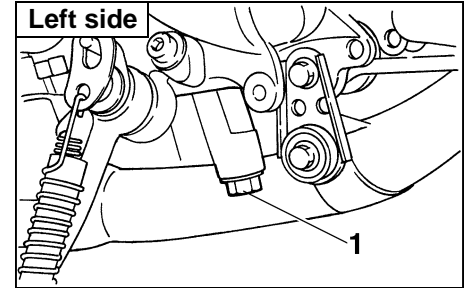

1. Engine oil drain bolt

4. Remove the engine oil filler cap and drain bolt to drain the oil from the crankcase.

**NOTE:** \_\_\_\_\_  
Skip steps 5–7 if the oil filter cartridge is not being replaced.

# PERIODIC MAINTENANCE AND MINOR REPAIR

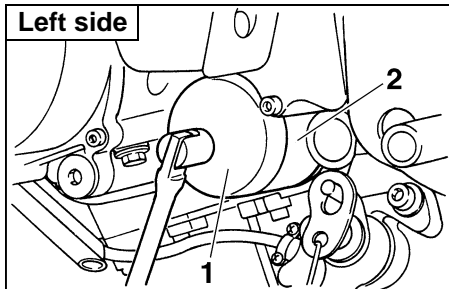

1. Oil filter wrench
2. Oil filter cartridge

5. Remove the oil filter cartridge with an oil filter wrench.

**NOTE:** \_\_\_\_\_

An oil filter wrench is available at a Yamaha dealer.

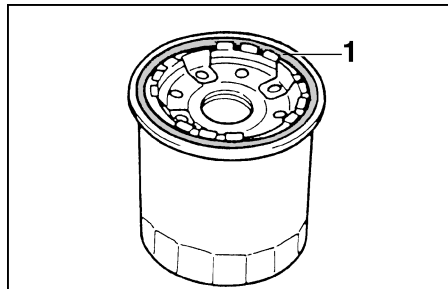

1. O-ring

6. Apply a thin coat of engine oil to the O-ring of the new oil filter cartridge.

**NOTE:** \_\_\_\_\_

Make sure that the O-ring is properly seated.

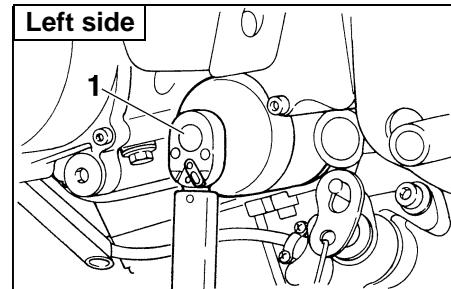

1. Torque wrench

7. Install the new oil filter cartridge, and then tighten it to the specified torque with a torque wrench.

Tightening torque:

Oil filter cartridge:

17 Nm (1.7 m·kg)

8. Install the engine oil drain bolt, and then tighten it to the specified torque.

Tightening torque:

Engine oil drain bolt:

43 Nm (4.3 m·kg)

# PERIODIC MAINTENANCE AND MINOR REPAIR

9. Add the specified amount of the recommended engine oil, and then install and tighten the oil filler cap.

Recommended engine oil:

See page 8-1.

Oil quantity:

Without oil filter cartridge replacement:

2.5 L

With oil filter cartridge replacement:

2.7 L

Total amount (dry engine):

3.5 L

EC000072

## CAUTION:

- In order to prevent clutch slippage (since the engine oil also lubricates the clutch), do not mix any chemical additives with the oil or use oils of a higher grade than “CD”. In addition, do not use oils labeled “ENERGY CONSERVING II” or higher.

- Make sure that no foreign material enters the crankcase.

10. Start the engine, and then let it idle for several minutes while checking it for oil leakage. If oil is leaking, immediately turn the engine off and check for the cause.

## NOTE:

After the engine is started, the engine oil level warning light should go off if the oil level is sufficient.

EC000067

## CAUTION:

If the oil level warning light flickers or remains on, immediately turn the engine off and have a Yamaha dealer check the vehicle.

11. Turn the engine off, and then check the oil level and correct it if necessary.
12. Install the cowling.

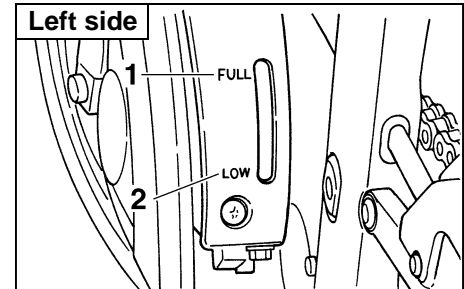

1. Maximum level mark
2. Minimum level mark

EAU01611

## Coolant

### To check the coolant level

1. Place the motorcycle on a level surface and hold it in an upright position.

## NOTE:

- The coolant level must be checked on a cold engine since the level varies with engine temperature.
- Make sure that the motorcycle is positioned straight up when checking the coolant level. A slight tilt to the side can result in a false reading.



# PERIODIC MAINTENANCE AND MINOR REPAIR

EW000067

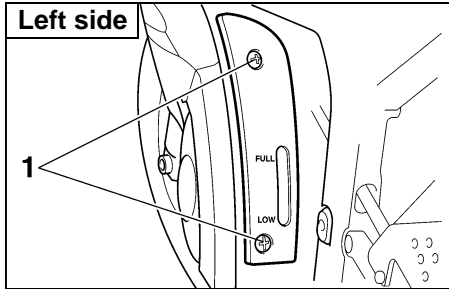

1. Bolt (× 2)

2. Check the coolant level in the coolant reservoir.

## NOTE:

The coolant should be between the minimum and maximum level marks.

3. If the coolant is at or below the minimum level mark, remove the coolant reservoir cover by removing the bolts, open the reservoir cap, add coolant to the maximum level mark, close the reservoir cap, and then install the reservoir cover and bolts.

Coolant reservoir capacity:  
0.44 L

EC000080

## CAUTION:

- If coolant is not available, use distilled water or soft tap water instead. Do not use hard water or salt water since it is harmful to the engine.
- If water has been used instead of coolant, replace it with coolant as soon as possible, otherwise the engine may not be sufficiently cooled and the cooling system will not be protected against frost and corrosion.
- If water has been added to the coolant, have a Yamaha dealer check the antifreeze content of the coolant as soon as possible, otherwise the effectiveness of the coolant will be reduced.

## WARNING

Never attempt to remove the radiator cap when the engine is hot.

## NOTE:

The radiator fan is automatically switched on or off according to the coolant temperature in the radiator. If the engine overheats, see page 6-46 for further instructions.

# PERIODIC MAINTENANCE AND MINOR REPAIR

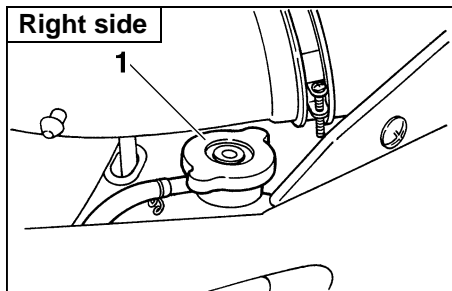

1. Radiator cap

EAU01612

## To change the coolant

1. Place the motorcycle on a level surface and let the engine cool off if necessary.
2. Remove panel C, and cowlings A and B. (See pages 6-6–6-8 for panel and cowlings removal and installation procedures.)
3. Place a container under the engine to collect the used coolant.
4. Remove the radiator cap.

EW000067

### **! WARNING**

**Never attempt to remove the radiator cap when the engine is hot.**

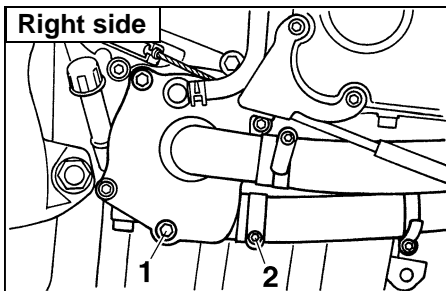

1. Water pump drain bolt
2. Clamp screw

5. Remove the water pump drain bolt to drain the water pump housing.
6. Loosen the clamp screw, and then disconnect the radiator hose to drain the radiator.
7. After the coolant is completely drained, thoroughly flush the cooling system with clean tap water.
8. Connect the radiator hose, and then tighten the clamp screw.
9. Install the coolant drain bolt, and then tighten it to the specified torque.

### **NOTE:**

Check the washer for damage and replace it if necessary.

Tightening torque:  
Coolant drain bolt:  
12 Nm (1.2 m·kg)

# PERIODIC MAINTENANCE AND MINOR REPAIR

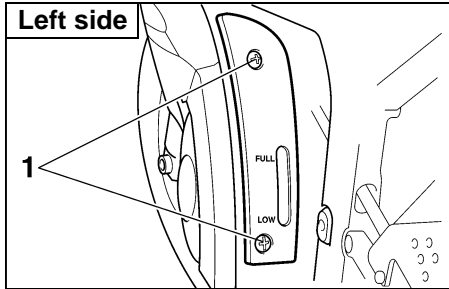

1. Bolt (× 2)

10. Remove the coolant reservoir cover by removing the bolts.

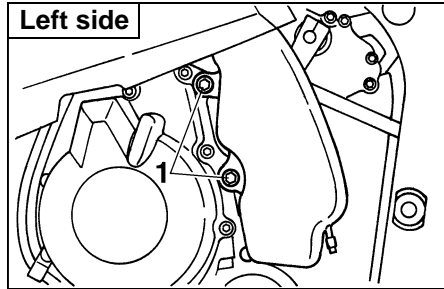

1. Bolt (× 2)

11. Remove the coolant reservoir by removing the bolts.
12. Remove the coolant reservoir cap, and then turn the reservoir upside-down to empty it.
13. Install the coolant reservoir by installing the bolts.
14. Pour the recommended coolant into the reservoir to the maximum level mark, and then install the cap and cover.
15. Pour the recommended coolant into the radiator until it is full.

Antifreeze/water mixture ratio:

1:1

Recommended antifreeze:

High-quality ethylene glycol antifreeze containing corrosion inhibitors for aluminum engines

Coolant quantity:

Total amount:

2.15 L

Coolant reservoir capacity:

0.44 L

# PERIODIC MAINTENANCE AND MINOR REPAIR

EC000080

## CAUTION:

- If coolant is not available, use distilled water or soft tap water instead. Do not use hard water or salt water since it is harmful to the engine.
  - If water has been used instead of coolant, replace it with coolant as soon as possible, otherwise the engine may not be sufficiently cooled and the cooling system will not be protected against frost and corrosion.
  - If water has been added to the coolant, have a Yamaha dealer check the antifreeze content of the coolant as soon as possible, otherwise the effectiveness of the coolant will be reduced.
16. Install the radiator cap, start the engine, let it idle for several minutes, and then turn it off.

17. Remove the radiator cap to check the coolant level in the radiator. If necessary, add sufficient coolant until it reaches the top of the radiator, and then install the radiator cap.
18. Start the engine, and then check the vehicle for coolant leakage. If coolant is leaking, have a Yamaha dealer check the cooling system.
19. Install the panel and the cowlings.

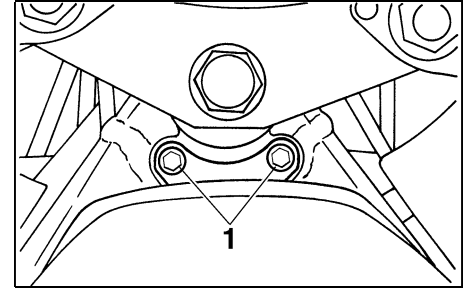

1. Bolt (× 2)

EAU03726

## Checking the air filter element

The air filter element should be checked at the intervals specified in the periodic maintenance and lubrication chart. Check the air filter element more frequently if you are riding in unusually wet or dusty areas.

1. Remove the rider seat. (See page 3-13 for rider seat removal and installation procedures.)
2. Remove the fuel tank bolts and lift the fuel tank as shown.

# PERIODIC MAINTENANCE AND MINOR REPAIR

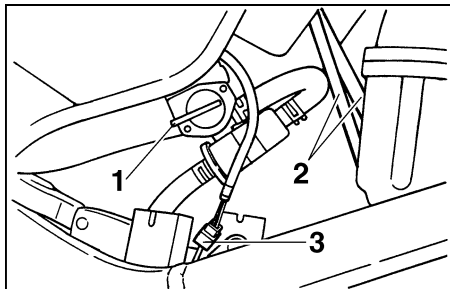

1. Fuel cock
2. Hose (× 2)
3. Fuel sender coupler

3. Turn the fuel cock lever to “OFF”, and then disconnect the hoses and the fuel sender coupler.

**NOTE:** \_\_\_\_\_  
Before removing the hoses, mark them to ensure that they will be reinstalled in their correct positions.

---

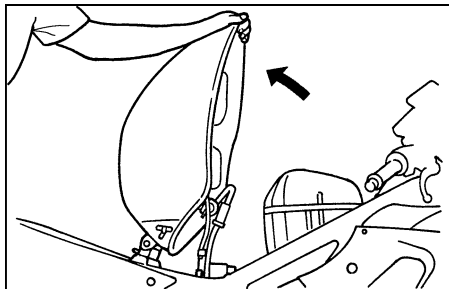

4. Tilt the front of the fuel tank back to position the tank away from the air filter case, and then support the tank as shown.

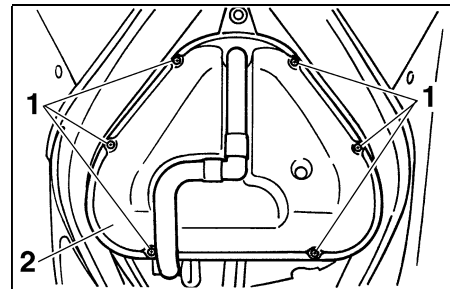

1. Screw (× 6)
2. Air filter case cover

5. Remove the air filter case cover by removing the screws.

# PERIODIC MAINTENANCE AND MINOR REPAIR

EW000131

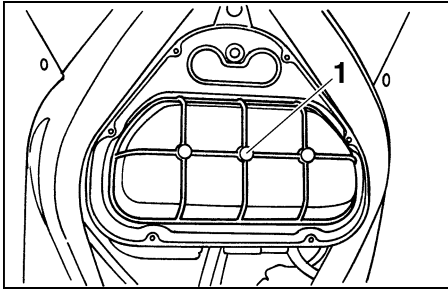

1. Air filter element

6. Pull the air filter element out.
7. Check the condition of the air filter element and replace it if it is damaged or excessively dusty.

8. Insert the element into the air filter case.

EC000082

## CAUTION:

- Make sure that the air filter element is properly seated in the air filter case.
  - The engine should never be operated without the air filter element installed, otherwise the piston(s) and/or cylinder(s) may become excessively worn.
9. Install the air filter case cover by installing the screws.
  10. Connect the fuel sender coupler and the hoses, turn the fuel cock lever to "ON", place the fuel tank in the original position, and then install the bolts.

## WARNING

Make sure that the fuel hoses and vacuum hose are properly connected and routed, and not pinched. Replace any damaged hoses.

11. Install the rider seat.

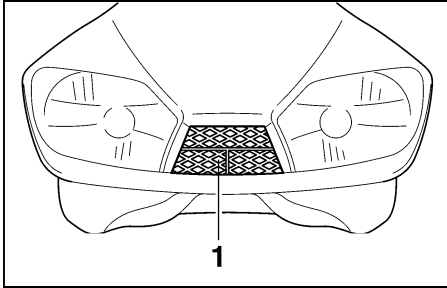

1. Air intake duct

EAU01335

## Air intake duct

Check that the screen of the intake duct is not blocked. Clean the screen if necessary.

EAU00630

## Adjusting the carburetors

The carburetors are important parts of the engine and require very sophisticated adjustment. Therefore, most carburetor adjustments should be left to a Yamaha dealer, who has the necessary professional knowledge and experience. The adjustment described in the following section, however, may be serviced by the owner as part of routine maintenance.

EC000095

### **CAUTION:**

**The carburetors have been set and extensively tested at the Yamaha factory. Changing these settings without sufficient technical knowledge may result in poor performance of or damage to the engine.**

# PERIODIC MAINTENANCE AND MINOR REPAIR

EAU00632

## Adjusting the engine idling speed

The engine idling speed must be checked and, if necessary, adjusted as follows at the intervals specified in the periodic maintenance and lubrication chart.

1. Start the engine and warm it up for several minutes at 1,000–2,000 r/min while occasionally revving it to 4,000–5,000 r/min.

**NOTE:** \_\_\_\_\_  
The engine is warm when it quickly responds to the throttle.

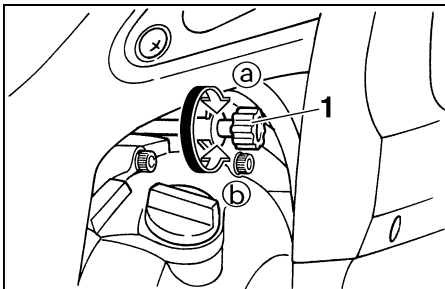

1. Throttle stop screw

2. Check the engine idling speed and, if necessary, adjust it to specification by turning the throttle stop screw. To increase the engine idling speed, turn the screw in direction ①. To decrease the engine idling speed, turn the screw in direction ②.

Engine idling speed:  
1,250–1,350 r/min

**NOTE:** \_\_\_\_\_  
If the specified idling speed cannot be obtained as described above, have a Yamaha dealer make the adjustment.

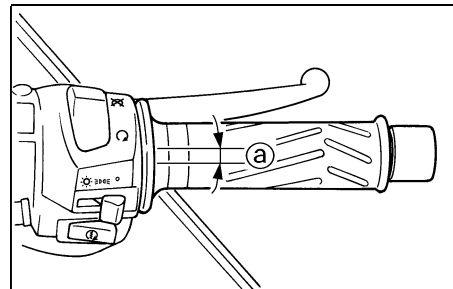

a. Throttle cable free play

EAU00635

## Adjusting the throttle cable free play

The throttle cable free play should measure 6–8 mm at the throttle grip. Periodically check the throttle cable free play and, if necessary, have a Yamaha dealer adjust it.



# PERIODIC MAINTENANCE AND MINOR REPAIR

## Adjusting the valve clearance

EAU00637

The valve clearance changes with use, resulting in improper air-fuel mixture and/or engine noise. To prevent this from occurring, the valve clearance must be adjusted by a Yamaha dealer at the intervals specified in the periodic maintenance and lubrication chart.

## Tires

To maximize the performance, durability, and safe operation of your motorcycle, note the following points regarding the specified tires.

### Tire air pressure

The tire air pressure should be checked and, if necessary, adjusted before each ride.

EAU00658

| Tire air pressure<br>(measured on cold tires) |  |  |
|---|--|--|
| Load*   | Front  | Rear   |
| Up to 90 kg                                   | 250 kPa<br>2.50 kg/cm <sup>2</sup><br>2.50 bar | 250 kPa<br>2.50 kg/cm <sup>2</sup><br>2.50 bar |
| 90 kg–maximum                                 | 250 kPa<br>2.50 kg/cm <sup>2</sup><br>2.50 bar | 290 kPa<br>2.90 kg/cm <sup>2</sup><br>2.90 bar |
| High-speed riding                             | 250 kPa<br>2.50 kg/cm <sup>2</sup><br>2.50 bar | 250 kPa<br>2.50 kg/cm <sup>2</sup><br>2.50 bar |

|               |        |
|---------------|--------|
| Maximum load* | 189 kg |
|---------------|--------|

\* Total weight of rider, passenger, cargo and accessories

### **WARNING**

- The tire air pressure must be checked and adjusted on cold tires (i.e., when the temperature of the tires equals the ambient temperature).
- The tire air pressure must be adjusted in accordance with the riding speed and with the total weight of rider, passenger, cargo, and accessories approved for this model.

EW000082

# PERIODIC MAINTENANCE AND MINOR REPAIR

EWA00012

## ⚠ WARNING

Because loading has an enormous impact on the handling, braking, performance and safety characteristics of your motorcycle, you should keep the following precautions in mind.

- **NEVER OVERLOAD THE MOTORCYCLE!** Operation of an overloaded motorcycle may result in tire damage, loss of control, or severe injury. Make sure that the total weight of rider, passenger, cargo, and accessories does not exceed the specified maximum load for the vehicle.
- Do not carry along loosely packed items, which can shift during a ride.
- Securely pack the heaviest items close to the center of the motorcycle and distribute the weight evenly on both sides.

- Adjust the suspension and tire air pressure with regard to the load.
- Check the tire condition and air pressure before each ride.

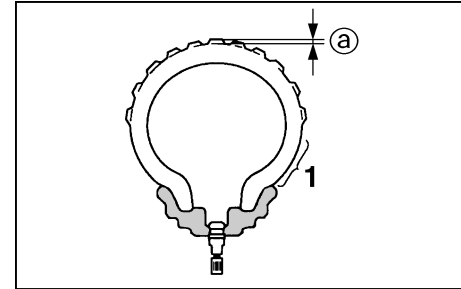

- 1. Tire sidewall
- a. Tire tread depth

## Tire inspection

The tires must be checked before each ride. If the center tread depth reaches the specified limit, if the tire has a nail or glass fragments in it, or if the sidewall is cracked, have a Yamaha dealer replace the tire immediately.

|  |        |
|--|--------|
| Minimum tire tread depth<br>(front and rear) | 1.6 mm |
|--|--------|

## NOTE:

The tire tread depth limits may differ from country to country. Always comply with the local regulations.

# PERIODIC MAINTENANCE AND MINOR REPAIR

EW000079

EW000080

## ! WARNING

- Have a Yamaha dealer replace excessively worn tires. Besides being illegal, operating the motorcycle with excessively worn tires decreases riding stability and can lead to loss of control.
- The replacement of all wheel- and brake-related parts, including the tires, should be left to a Yamaha dealer, who has the necessary professional knowledge and experience.

### Tire information

This motorcycle is equipped with cast wheels and tubeless tires with valves.

## ! WARNING

- The front and rear tires should be of the same make and design, otherwise the handling characteristics of the motorcycle cannot be guaranteed.
- After extensive tests, only the tires listed below have been approved for this model by Yamaha Motor Co., Ltd.
- Always make sure that the valve caps are securely installed to prevent air pressure leakage.
- Use only the tire valves and valve cores listed below to avoid tire deflation during a high-speed ride.

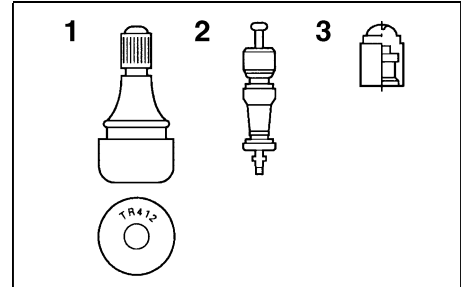

1. Tire air valve
2. Tire air valve core
3. Tire air valve cap with seal

### FRONT

| Manufacturer | Size              | Model         |
|--------------|-------------------|---------------|
| MICHELIN     | 120/60 ZR17 (55W) | Pilot SPORT B |
| Dunlop       | 120/60 ZR17 (55W) | D207FJ        |

### REAR

| Manufacturer | Size              | Model         |
|--------------|-------------------|---------------|
| MICHELIN     | 180/55 ZR17 (73W) | Pilot SPORT B |
| Dunlop       | 180/55 ZR17 (73W) | D207N         |

| FRONT & REAR   |                   |
|----------------|-------------------|
| Tire air valve | TR412             |
| Valve core     | #9000A (original) |

# PERIODIC MAINTENANCE AND MINOR REPAIR

EAU00684

## ⚠ WARNING

This motorcycle is fitted with super-high-speed tires. Note the following points in order to make the most efficient use of these tires.

- Use only the specified replacement tires. Other tires may run the danger of bursting at super high speeds.
- Brand-new tires can have a relatively poor grip on certain road surfaces until they have been “broken in”. Therefore, it is advisable before doing any high-speed riding to ride conservatively for approximately 100 km after installing a new tire.
- The tires must be warmed up before a high-speed run.
- Always adjust the tire air pressure according to the operating conditions.

EAU00687

## Wheels

To maximize the performance, durability, and safe operation of your motorcycle, note the following points regarding the specified wheels.

- The wheel rims should be checked for cracks, bends or warpage before each ride. If any damage is found, have a Yamaha dealer replace the wheel. Do not attempt even the smallest repair to the wheel. A deformed or cracked wheel must be replaced.
- The wheel should be balanced whenever either the tire or wheel has been changed or replaced. An unbalanced wheel can result in poor performance, adverse handling characteristics, and a shortened tire life.
- Ride at moderate speeds after changing a tire since the tire surface must first be “broken in” for it to develop its optimal characteristics.

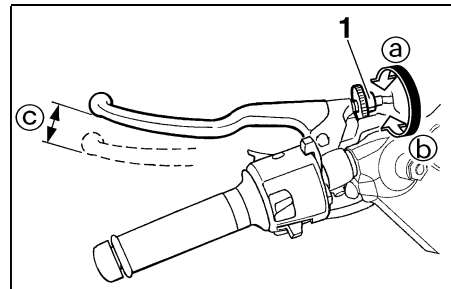

1. Clutch lever free play adjusting bolt
- c. Clutch lever free play

EAU01356

## Adjusting the clutch lever free play

The clutch lever free play should measure 10–15 mm as shown. Periodically check the clutch lever free play and, if necessary, adjust it as follows. To increase the clutch lever free play, turn the adjusting bolt at the clutch lever in direction ①. To decrease the clutch lever free play, turn the adjusting bolt in direction ②.

# PERIODIC MAINTENANCE AND MINOR REPAIR

## NOTE:

If the specified clutch lever free play cannot be obtained as described above, proceed as follows.

1. Fully turn the adjusting bolt at the clutch lever in direction ① to loosen the clutch cable.

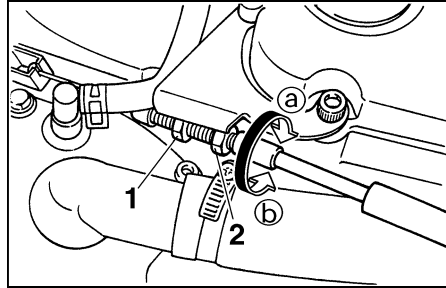

1. Locknut
2. Clutch lever free play adjusting nut
2. Remove cowling A. (See page 6-6 for cowling removal and installation procedures.)
3. Loosen the locknut at the crankcase.
4. To increase the clutch lever free play, turn the adjusting nut in direction ①. To decrease the clutch lever free play, turn the adjusting nut in direction ②.
5. Tighten the locknut.
6. Install the cowling.

# PERIODIC MAINTENANCE AND MINOR REPAIR

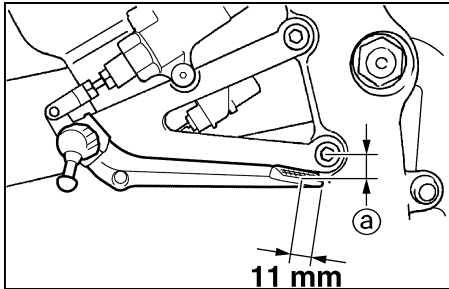

a. Distance between brake pedal and footrest bracket

EAU01357

## Adjusting the brake pedal position

The top of the brake pedal should be positioned approximately 7–11 mm below the bottom of the footrest bracket as shown. Periodically check the brake pedal position and, if necessary, have a Yamaha dealer adjust it.

EW000109

### **⚠ WARNING**

A soft or spongy feeling in the brake pedal can indicate the presence of air in the hydraulic system. If there is air in the hydraulic system, have a Yamaha dealer bleed the system before operating the motorcycle. Air in the hydraulic system will diminish the braking performance, which may result in loss of control and an accident.

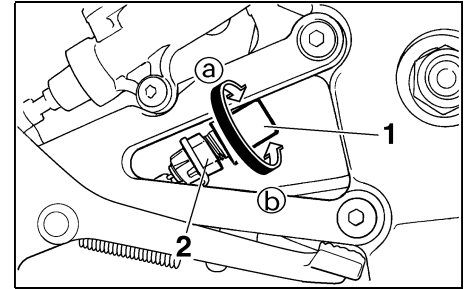

1. Rear brake light switch
2. Rear brake light switch adjusting nut

EAU00713

## Adjusting the rear brake light switch

The rear brake light switch, which is activated by the brake pedal, is properly adjusted when the brake light comes on just before braking takes effect. If necessary, adjust the brake light switch as follows.

Turn the adjusting nut while holding the rear brake light switch in place. To make the brake light come on earlier, turn the adjusting nut in direction **Ⓐ**. To make the brake light come on later, turn the adjusting nut in direction **Ⓑ**.

# PERIODIC MAINTENANCE AND MINOR REPAIR

## Checking the front and rear brake pads

EAU00721

The front and rear brake pads must be checked for wear at the intervals specified in the periodic maintenance and lubrication chart.

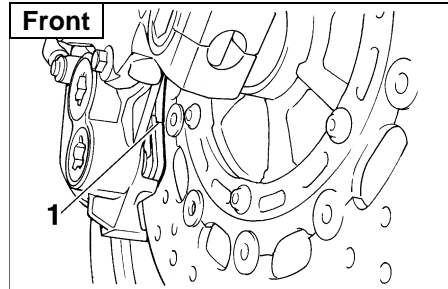

1. Front brake pad wear indicator groove

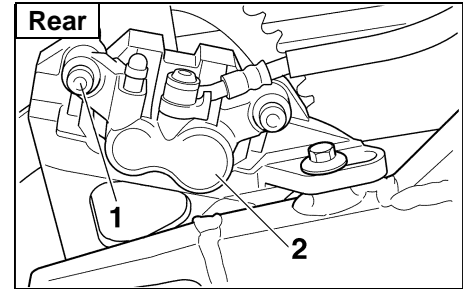

1. Bolt  
2. Rear brake caliper

### Front brake pads

EAU00725

Each front brake pad is provided with a wear indicator groove, which allows you to check the brake pad wear without having to disassemble the brake. To check the brake pad wear, check the wear indicator groove. If a brake pad has worn to the point that the wear indicator groove has almost disappeared, have a Yamaha dealer replace the brake pads as a set.

### Rear brake pads

EAU01641

Each rear brake pad is provided with a wear indicator groove, which allows you to check the brake pad wear without having to disassemble the brake. Check the brake pad wear as follows.

1. Remove the rear brake caliper by removing the bolt, and then tilt the caliper forward to inspect the wear indicator groove. If a brake pad has worn to the point that the wear indicator groove has almost disappeared, have a Yamaha dealer replace the brake pads as a set.

# PERIODIC MAINTENANCE AND MINOR REPAIR

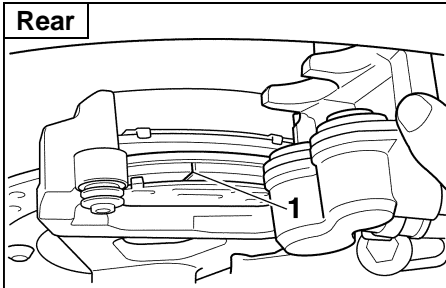

1. Rear brake pad wear indicator groove
2. Install the brake caliper by installing the bolt, then tightening it to the specified torque.

Tightening torque:  
Brake caliper bolt:  
40 Nm (4.0 m·kg)

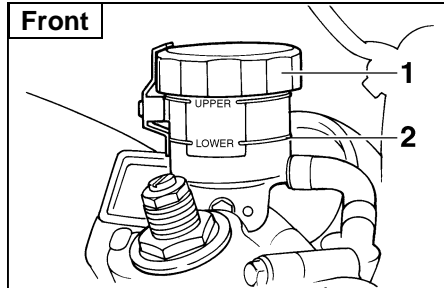

1. Front brake fluid reservoir
2. Minimum level mark

EAU03776

## Checking the brake fluid level

Insufficient brake fluid may allow air to enter the brake system, possibly causing it to become ineffective.

Before riding, check that the brake fluid is above the minimum level mark and replenish if necessary. A low brake fluid level may indicate worn brake pads and/or brake system leakage. If the brake level is low, be sure to check the brake pads for wear and the brake system for leakage.

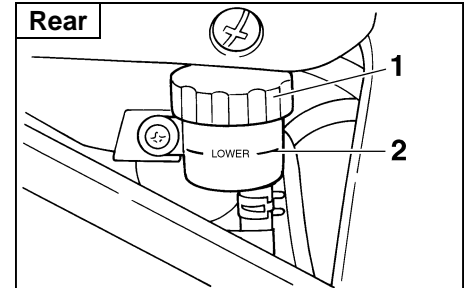

1. Rear brake fluid reservoir
2. Minimum level mark

Observe these precautions:

- When checking the fluid level, make sure that the top of the brake fluid reservoir is level.
- Use only the recommended quality brake fluid, otherwise the rubber seals may deteriorate, causing leakage and poor braking performance.

Recommended brake fluid: DOT 4

- Refill with the same type of brake fluid. Mixing fluids may result in a harmful chemical reaction and lead to poor braking performance.



- Be careful that water does not enter the brake fluid reservoir when refilling. Water will significantly lower the boiling point of the fluid and may result in vapor lock.
- Brake fluid may deteriorate painted surfaces or plastic parts. Always clean up spilled fluid immediately.
- As the brake pads wear, it is normal for the brake fluid level to gradually go down. However, if the brake fluid level goes down suddenly, have a Yamaha dealer check the cause.

EAU03238

## Changing the brake fluid

Have a Yamaha dealer change the brake fluid at the intervals specified in the periodic maintenance and lubrication chart. In addition, have the oil seals of the brake master cylinder and caliper as well as the brake hose replaced at the intervals listed below or whenever they are damaged or leaking.

- Oil seals: Replace every two years.
- Brake hose: Replace every four years.

# PERIODIC MAINTENANCE AND MINOR REPAIR

EAU00744

## Drive chain slack

The drive chain slack should be checked before each ride and adjusted if necessary.

### To check the drive chain slack

1. Place the motorcycle on a level surface and hold it in an upright position.

### NOTE:

When checking and adjusting the drive chain slack, the motorcycle should be positioned straight up and there should be no weight on it.

2. Shift the transmission into the neutral position.

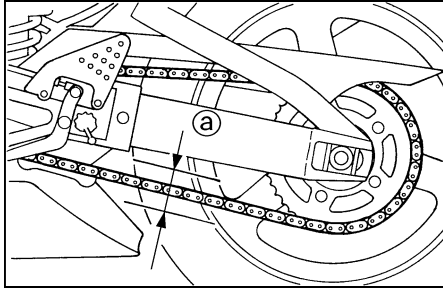

a. Drive chain slack

3. Move the rear wheel by pushing the motorcycle to locate the tightest portion of the drive chain, and then measure the drive chain slack as shown.

Drive chain slack:  
40–50 mm

4. If the drive chain slack is incorrect, adjust it as follows.

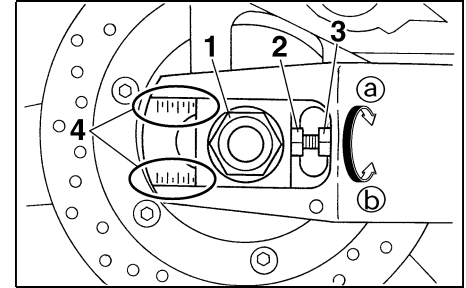

1. Axle nut
2. Drive chain slack adjusting bolt
3. Locknut
4. Alignment marks

EAU01251

### To adjust the drive chain slack

1. Loosen the axle nut and the chain puller locknut on each side of the swingarm.
2. To tighten the drive chain, turn the adjusting bolt on each side of the swingarm in direction Ⓐ. To loosen the drive chain, turn the adjusting bolt on each side of the swingarm in direction Ⓑ, and then push the rear wheel forward.

# PERIODIC MAINTENANCE AND MINOR REPAIR

## NOTE:

Using the alignment marks on each side of the swingarm, make sure that both chain pullers are in the same position for proper wheel alignment.

EC000096

## CAUTION:

**Improper drive chain slack will overload the engine as well as other vital parts of the motorcycle and can lead to chain slippage or breakage. To prevent this from occurring, keep the drive chain slack within the specified limits.**

3. Tighten the locknuts, and then tighten the axle nut to the specified torque.

Tightening torque:

Axle nut:

150 Nm (15.0 m·kg)

## Lubricating the drive chain

EAU03006

The drive chain must be cleaned and lubricated at the intervals specified in the periodic maintenance and lubrication chart, otherwise it will quickly wear out, especially when riding in dusty or wet areas. Service the drive chain as follows.

EC000097

## CAUTION:

**The drive chain must be lubricated after washing the motorcycle or riding in the rain.**

1. Clean the drive chain with kerosene and a small soft brush.

ECA00053

## CAUTION:

**To prevent damaging the O-rings, do not clean the drive chain with steam cleaners, high-pressure washers or inappropriate solvents.**

2. Wipe the drive chain dry.
3. Thoroughly lubricate the drive chain with a special O-ring chain lubricant.

ECA00052

## CAUTION:

**Do not use engine oil or any other lubricants for the drive chain, as they may contain substances that could damage the O-rings.**

# PERIODIC MAINTENANCE AND MINOR REPAIR

## Checking and lubricating the cables

EAU02962

The operation of all control cables and the condition of the cables should be checked before each ride, and the cables and cable ends should be lubricated if necessary. If a cable is damaged or does not move smoothly, have a Yamaha dealer check or replace it.

Recommended lubricant:  
Engine oil

EW000112

### **WARNING**

**Damage to the outer sheath may interfere with proper cable operation and will cause the inner cable to rust. Replace a damaged cable as soon as possible to prevent unsafe conditions.**

## Checking and lubricating the throttle grip and cable

EAU03764

The operation of the throttle grip and the condition of the throttle cable should be checked before each ride, and the cable should be lubricated or replaced if necessary.

**NOTE:** \_\_\_\_\_  
Since the throttle grip must be removed to access the throttle cable end, the throttle grip and the cable should always be lubricated at the same time.

1. Remove the throttle grip by removing the screws.
2. Hold up the throttle cable and then apply several drops of oil to the cable, allowing it to trickle into the sheaths.
3. Grease the inside of the throttle grip housing.
4. Grease the metal-to-metal contact surface of the throttle grip, and then install the grip by installing the screws.

Recommended lubricant:

Throttle cable:

Engine oil

Throttle grip housing and grip:

Lithium-soap-based grease

(all-purpose grease)

# PERIODIC MAINTENANCE AND MINOR REPAIR

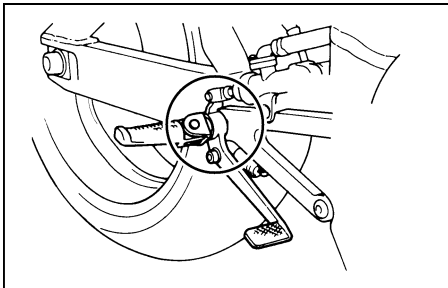

EAU03163

## Lubricating the brake pedal

The operation of the brake pedal should be checked before each ride, and the pedal pivot should be lubricated if necessary.

Recommended lubricant:

Lithium-soap-based grease  
(all-purpose grease)

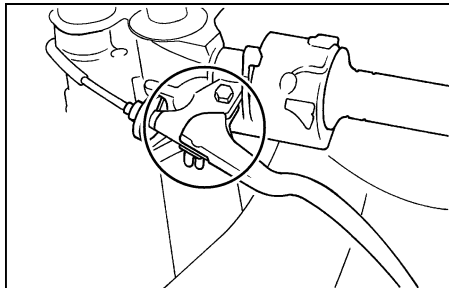

EAU03164

## Checking and lubricating the brake and clutch levers

The operation of the brake and clutch levers should be checked before each ride, and the lever pivots should be lubricated if necessary.

Recommended lubricant:

Lithium-soap-based grease  
(all-purpose grease)

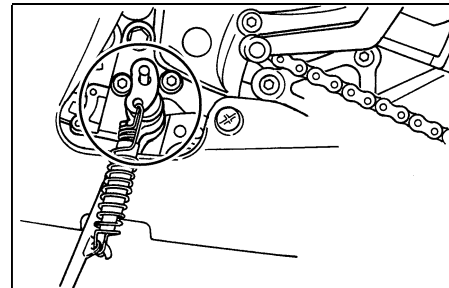

EAU03165

## Checking and lubricating the sidestand

The operation of the sidestand should be checked before each ride, and the sidestand pivot and metal-to-metal contact surfaces should be lubricated if necessary.

EW000113

**⚠ WARNING**

**If the sidestand does not move up and down smoothly, have a Yamaha dealer check or repair it.**

Recommended lubricant:

Lithium-soap-based grease  
(all-purpose grease)

# PERIODIC MAINTENANCE AND MINOR REPAIR

## Lubricating the rear suspension

EAU03166

The pivoting points of the rear suspension must be lubricated at the intervals specified in the periodic maintenance and lubrication chart.

Recommended lubricant:  
Lithium-soap-based grease  
(all-purpose grease)

## Checking the front fork

EAU02939

The condition and operation of the front fork must be checked as follows at the intervals specified in the periodic maintenance and lubrication chart.

### To check the condition

EW000115

#### **⚠ WARNING**

**Securely support the motorcycle so that there is no danger of it falling over.**

Check the inner tubes for scratches, damage and excessive oil leakage.

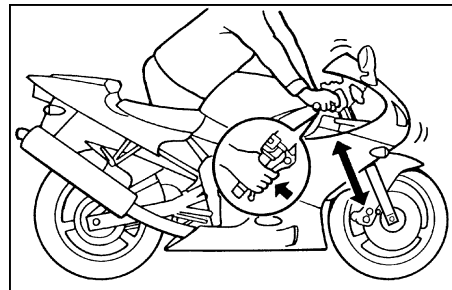

### To check the operation

1. Place the motorcycle on a level surface and hold it in an upright position.
2. While applying the front brake, push down hard on the handlebars several times to check if the front fork compresses and rebounds smoothly.

EC000098

#### **CAUTION:**

**If any damage is found or the front fork does not operate smoothly, have a Yamaha dealer check or repair it.**

# PERIODIC MAINTENANCE AND MINOR REPAIR

## Checking the steering

EAU00794

Worn or loose steering bearings may cause danger. Therefore, the operation of the steering must be checked as follows at the intervals specified in the periodic maintenance and lubrication chart.

1. Place a stand under the engine to raise the front wheel off the ground.

EW000115

### **WARNING**

**Securely support the motorcycle so that there is no danger of it falling over.**

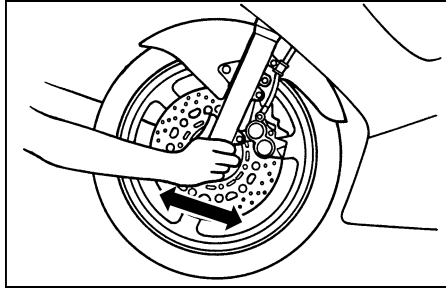

2. Hold the lower ends of the front fork legs and try to move them forward and backward. If any free play can be felt, have a Yamaha dealer check or repair the steering.

## Checking the wheel bearings

EAU01144

The front and rear wheel bearings must be checked at the intervals specified in the periodic maintenance and lubrication chart. If there is play in the wheel hub or if the wheel does not turn smoothly, have a Yamaha dealer check the wheel bearings.

# PERIODIC MAINTENANCE AND MINOR REPAIR

EAU01291

EW000116

## Battery

This motorcycle is equipped with a sealed-type (MF) battery, which does not require any maintenance. There is no need to check the electrolyte or to add distilled water.

### To charge the battery

Have a Yamaha dealer charge the battery as soon as possible if it seems to have discharged. Keep in mind that the battery tends to discharge more quickly if the motorcycle is equipped with optional electrical accessories.

### WARNING

- **Electrolyte is poisonous and dangerous since it contains sulfuric acid, which causes severe burns. Avoid any contact with skin, eyes or clothing and always shield your eyes when working near batteries. In case of contact, administer the following FIRST AID.**
  - **EXTERNAL: Flush with plenty of water.**
  - **INTERNAL: Drink large quantities of water or milk and immediately call a physician.**
  - **EYES: Flush with water for 15 minutes and seek prompt medical attention.**
- **Batteries produce explosive hydrogen gas. Therefore, keep sparks, flames, cigarettes, etc., away from the battery and provide sufficient ventilation when charging it in an enclosed space.**

- **KEEP THIS AND ALL BATTERIES OUT OF THE REACH OF CHILDREN.**

### To store the battery

1. If the motorcycle will not be used for more than one month, remove the battery, fully charge it, and then place it in a cool, dry place.
2. If the battery will be stored for more than two months, check it at least once a month and fully charge it if necessary.
3. Fully charge the battery before installation.
4. After installation, make sure that the battery leads are properly connected to the battery terminals.



# PERIODIC MAINTENANCE AND MINOR REPAIR

EC000102

## CAUTION:

- Always keep the battery charged. Storing a discharged battery can cause permanent battery damage.
- To charge a sealed-type (MF) battery, a special (constant-voltage) battery charger is required. Using a conventional battery charger will damage the battery. If you do not have access to a sealed-type (MF) battery charger, have a Yamaha dealer charge your battery.

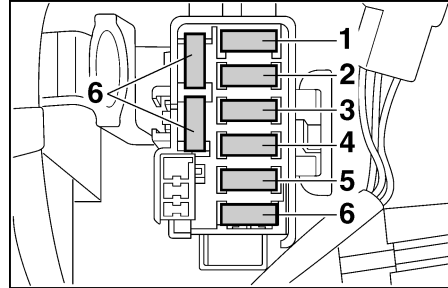

1. Headlight fuse
2. Radiator fan fuse
3. Ignition fuse
4. Signaling system fuse
5. Odometer fuse
6. Spare fuse (× 3)

EAU01754

## Replacing the fuses

The fuse box is located under the rider seat. (See page 3-13 for rider seat removal and installation procedures.)

If a fuse is blown, replace it as follows.

1. Turn the key to "OFF" and turn off the electrical circuit in question.
2. Remove the blown fuse, and then install a new fuse of the specified amperage.

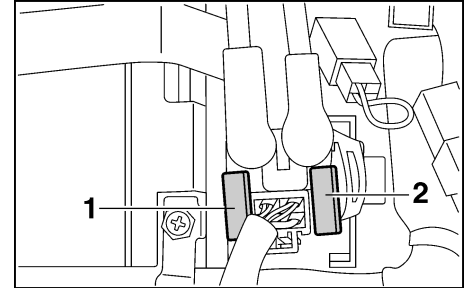

1. Main fuse
2. Spare main fuse

### Specified fuses:

|                        |       |
|------------------------|-------|
| Main fuse:             | 30 A  |
| Headlight fuse:        | 20 A  |
| Signaling system fuse: | 15 A  |
| Radiator fan fuse:     | 7.5 A |
| Ignition fuse:         | 15 A  |
| Odometer fuse:         | 7.5 A |

# PERIODIC MAINTENANCE AND MINOR REPAIR

EC000103

## CAUTION:

Do not use a fuse of a higher amperage rating than recommended to avoid causing extensive damage to the electrical system and possibly a fire.

3. Turn the key to "ON" and turn on the electrical circuit in question to check if the device operates.
4. If the fuse immediately blows again, have a Yamaha dealer check the electrical system.

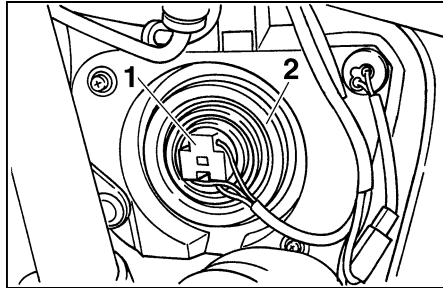

1. Headlight coupler
2. Headlight bulb cover

EAU01822

## Replacing the headlight bulb

This motorcycle is equipped with a quartz bulb headlight. If the headlight bulb burns out, replace it as follows.

1. Remove panel C. (See page 6-8 for panel removal and installation procedures.)
2. Disconnect the headlight coupler, and then remove the headlight bulb cover.

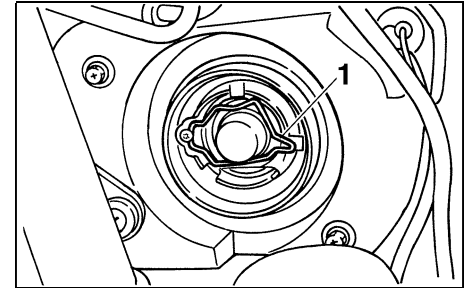

1. Headlight bulb holder
3. Unhook the headlight bulb holder, and then remove the defective bulb.

EW000119

## WARNING

Headlight bulbs get very hot. Therefore, keep flammable products away from a lit headlight bulb, and do not touch the bulb until it has cooled down.

4. Place a new bulb into position, and then secure it with the bulb holder.

EC000104

## CAUTION:

Take care not to damage the following parts:

### ● Headlight bulb

Do not touch the glass part of the headlight bulb to keep it free from oil, otherwise the transparency of the glass, the luminosity of the bulb, and the bulb life will be adversely affected. Thoroughly clean off any dirt and fingerprints on the headlight bulb using a cloth moistened with alcohol or thinner.

### ● Headlight lens

- Do not affix any type of tinted film or stickers to the headlight lens.
  - Do not use a headlight bulb of a wattage higher than specified.
5. Install the bulb cover, and then connect the coupler.
  6. Install the panel.
  7. Have a Yamaha dealer adjust the headlight beam if necessary.

## Tail/brake light

This motorcycle is equipped with an LED type of tail/brake light. If the tail/brake light does not come on, have a Yamaha dealer check it.

EAU03730

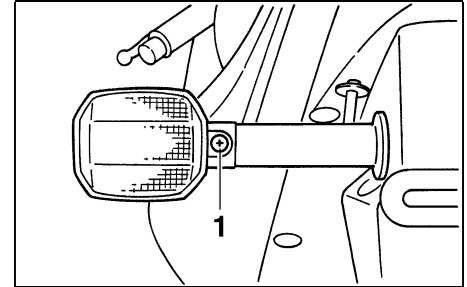

1. Screw

EAU03497

## Replacing a turn signal light bulb

1. Remove the turn signal light lens by removing the screw.
2. Remove the defective bulb by pushing it in and turning it counterclockwise.
3. Insert a new bulb into the socket, push it in, and then turn it clockwise until it stops.
4. Install the lens by installing the screw.

ECA00065

## CAUTION:

Do not overtighten the screw, otherwise the lens may break.

# PERIODIC MAINTENANCE AND MINOR REPAIR

## Supporting the motorcycle

EAU01579

Since this model is not equipped with a centerstand, follow these precautions when removing the front and rear wheel or performing other maintenance requiring the motorcycle to stand upright. Check that the motorcycle is in a stable and level position before starting any maintenance. A strong wooden box can be placed under the engine for added stability.

## To service the front wheel

1. Stabilize the rear of the motorcycle by using a motorcycle stand or, if an additional motorcycle stand is not available, by placing a jack under the frame in front of the rear wheel.
2. Raise the front wheel off the ground by using a motorcycle stand.

## To service the rear wheel

Raise the rear wheel off the ground by using a motorcycle stand or, if a motorcycle stand is not available, by placing a jack either under each side of the frame in front of the rear wheel or under each side of the swingarm.

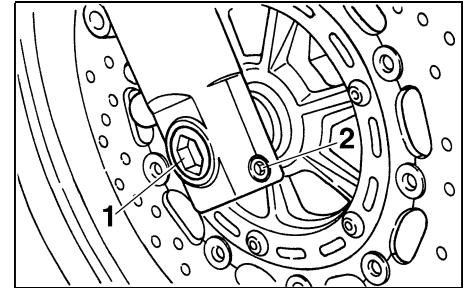

1. Wheel axle
2. Front wheel axle pinch bolt

EAU01617

## Front wheel

### To remove the front wheel

EW000122

#### **! WARNING**

- It is advisable to have a Yamaha dealer service the wheel.
- Securely support the motorcycle so that there is no danger of it falling over.

1. Loosen the front wheel axle pinch bolt, then the brake caliper bolts.
2. Loosen the wheel axle with a 19-mm hexagon wrench.

# PERIODIC MAINTENANCE AND MINOR REPAIR

EAU01638

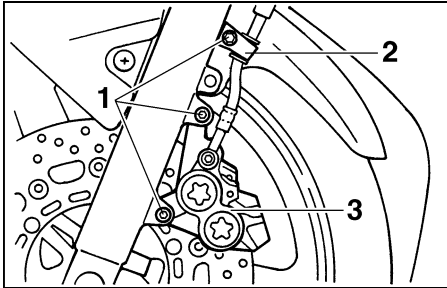

1. Bolt (× 3)
2. Brake hose holder
3. Front brake caliper

3. Lift the front wheel off the ground according to the procedure on page 6-41.
4. Remove the brake hose holders by removing the bolts.
5. Remove the brake calipers by removing the bolts.
6. Pull the wheel axle out, and then remove the wheel.

ECA00046

## CAUTION:

**Do not apply the brake after the brake calipers have been removed, otherwise the brake pads will be forced shut.**

## To install the front wheel

1. Lift the wheel up between the fork legs.
2. Insert the wheel axle.
3. Lower the front wheel so that it is on the ground.
4. Push down hard on the handlebar several times to check for proper fork operation.
5. Install the brake calipers by installing the bolts.

## NOTE:

Make sure that there is enough space between the brake pads before installing the brake calipers onto the brake discs.

6. Install the brake hose holders by installing the bolts.
7. Install the front wheel axle pinch bolt, and then tighten the wheel axle, pinch bolt and brake caliper bolts to the specified torques.

## Tightening torques:

Wheel axle:

72 Nm (7.2 m·kg)

Front wheel axle pinch bolt:

20 Nm (2.0 m·kg)

Brake caliper bolt:

40 Nm (4.0 m·kg)

# PERIODIC MAINTENANCE AND MINOR REPAIR

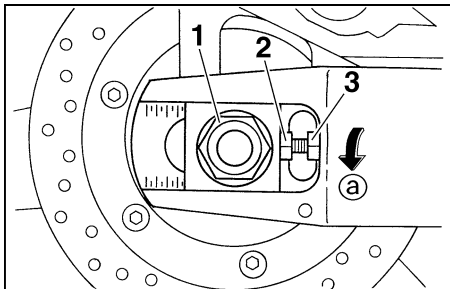

1. Axle nut
2. Drive chain slack adjusting bolt
3. Locknut

EAU03537

## Rear wheel

6

### To remove the rear wheel

EW000122

#### **WARNING**

- It is advisable to have a Yamaha dealer service the wheel.
- Securely support the motorcycle so that there is no danger of it falling over.

1. Loosen the axle nut and the brake caliper bolts.
2. Lift the rear wheel off the ground according to the procedure on page 6-41.

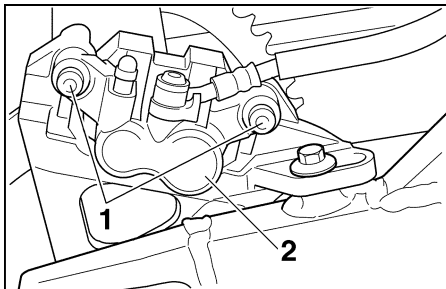

1. Bolt (× 2)
2. Rear brake caliper
3. Remove the axle nut, and then remove the brake caliper by removing the bolts.
4. Loosen the locknut on each side of the swingarm.
5. Turn the drive chain adjusting bolts fully in direction (a).

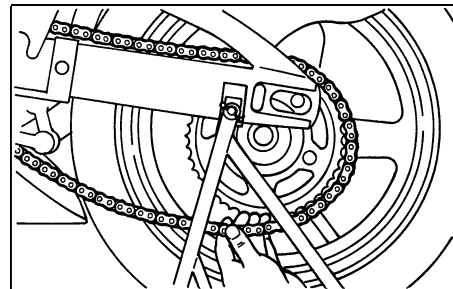

6. Push the wheel forward, and then remove the drive chain from the rear sprocket.

**NOTE:** \_\_\_\_\_  
The drive chain does not need to be disassembled in order to remove and install the rear wheel.

7. Pull the wheel axle out, and then remove the wheel.

ECA00048

**CAUTION:** \_\_\_\_\_  
Do not apply the brake after the wheel has been removed together with the brake disc, otherwise the brake pads will be forced shut.

EAU03538

## To install the rear wheel

1. Install the wheel by inserting the wheel axle from the left hand side.
2. Install the drive chain onto the rear sprocket, and then adjust the drive chain slack. (See page 6-31 for drive chain slack adjustment procedures.)
3. Install the axle nut, and then lower the rear wheel so that it is on the ground.
4. Install the brake caliper by installing the bolts.

### NOTE:

Make sure that there is enough space between the brake pads before installing the brake caliper onto the brake disc.

5. Tighten the axle nut and the brake caliper bolts to the specified torques.

### Tightening torques:

Axle nut:

150 Nm (15.0 m·kg)

Brake caliper bolt:

40 Nm (4.0 m·kg)

EAU03087

## Troubleshooting

Although Yamaha motorcycles receive a thorough inspection before shipment from the factory, trouble may occur during operation. Any problem in the fuel, compression, or ignition systems, for example, can cause poor starting and loss of power.

The following troubleshooting charts represent quick and easy procedures for checking these vital systems yourself. However, should your motorcycle require any repair, take it to a Yamaha dealer, whose skilled technicians have the necessary tools, experience, and know-how to service the motorcycle properly.

Use only genuine Yamaha replacement parts. Imitation parts may look like Yamaha parts, but they are often inferior, have a shorter service life and can lead to expensive repair bills.

# PERIODIC MAINTENANCE AND MINOR REPAIR

EAU02990

## Troubleshooting charts

### Starting problems or poor engine performance

EW000125



**WARNING**

**Keep away from open flames and do not smoke while checking or working on the fuel system.**

#### 1. Fuel

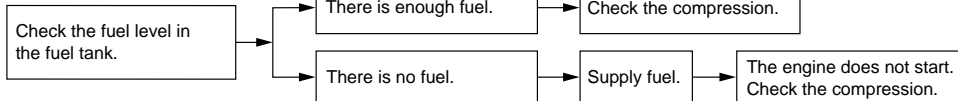

#### 2. Compression

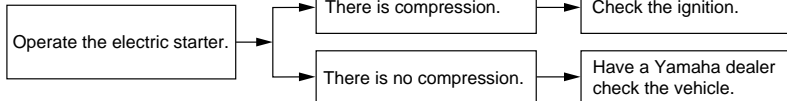

#### 3. Ignition

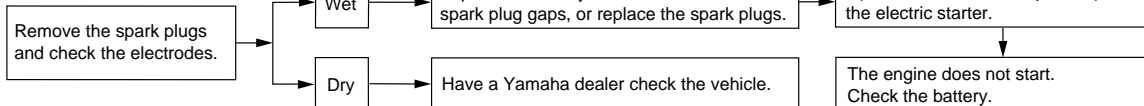

#### 4. Battery

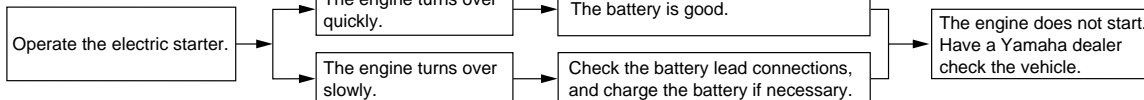

6



# PERIODIC MAINTENANCE AND MINOR REPAIR

## Engine overheating

EW000070

### **⚠ WARNING**

- Do not remove the radiator cap when the engine and radiator are hot. Scalding hot fluid and steam may be blown out under pressure, which could cause serious injury. Be sure to wait until the engine has cooled.
- After removing the radiator cap retaining bolt, place a thick rag, like a towel, over the radiator cap, and then slowly rotate the cap counterclockwise to the detent to allow any residual pressure to escape. When the hissing sound has stopped, press down on the cap while turning it counterclockwise, and then remove the cap.

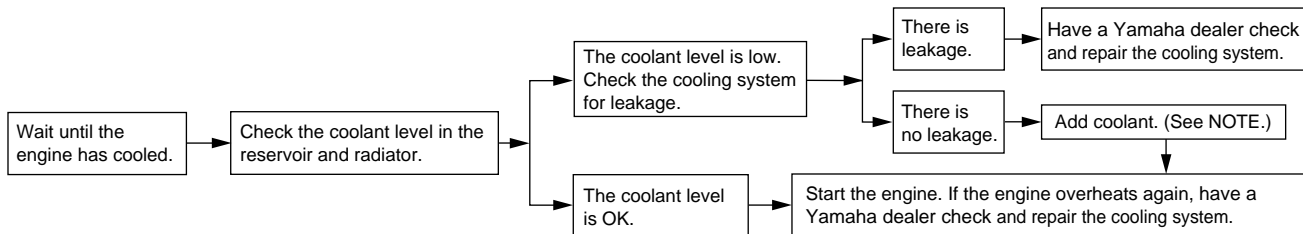

### **NOTE:**

If coolant is not available, tap water can be temporarily used instead, provided that it is changed to the recommended coolant as soon as possible.



# MOTORCYCLE CARE AND STORAGE

---

---

|               |     |
|---------------|-----|
| Care .....    | 7-1 |
| Storage ..... | 7-4 |

## Care

While the open design of a motorcycle reveals the attractiveness of the technology, it also makes it more vulnerable. Rust and corrosion can develop even if high-quality components are used. A rusty exhaust pipe may go unnoticed on a car, however, it detracts from the overall appearance of a motorcycle. Frequent and proper care does not only comply with the terms of the warranty, but it will also keep your motorcycle looking good, extend its life and optimize its performance.

## Before cleaning

1. Cover the muffler outlet with a plastic bag after the engine has cooled down.
2. Make sure that all caps and covers as well as all electrical couplers and connectors, including the spark plug caps, are tightly installed.
3. Remove extremely stubborn dirt, like oil burnt onto the crankcase, with a degreasing agent and a brush, but never apply such products onto seals, gaskets, sprockets, the drive chain and wheel axles. Always rinse the dirt and degreaser off with water.

## Cleaning

ECA00010

### CAUTION:

- **Avoid using strong acidic wheel cleaners, especially on spoked wheels. If such products are used on hard-to-remove dirt, do not leave the cleaner on the affected area any longer than instructed. Also, thoroughly rinse the area off with water, immediately dry it, and then apply a corrosion protection spray.**
- **Improper cleaning can damage windshields, cowlings, panels and other plastic parts. Use only a soft, clean cloth or sponge with mild detergent and water to clean plastic.**

# MOTORCYCLE CARE AND STORAGE

- Do not use any harsh chemical products on plastic parts. Be sure to avoid using cloths or sponges which have been in contact with strong or abrasive cleaning products, solvent or thinner, fuel (gasoline), rust removers or inhibitors, brake fluid, antifreeze or electrolyte.
- Do not use high-pressure washers or steam-jet cleaners since they cause water seepage and deterioration in the following areas: seals (of wheel and swing-arm bearings, fork and brakes), electric components (couplers, connectors, instruments, switches and lights), breather hoses and vents.
- For motorcycles equipped with a windshield: Do not use strong cleaners or hard sponges as they will cause dulling or scratching. Some cleaning compounds for plastic may leave scratches on the wind-

shield. Test the product on a small hidden part of the windshield to make sure that it does not leave any marks. If the windshield is scratched, use a quality plastic polishing compound after washing.

## After normal use

Remove dirt with warm water, a mild detergent, and a soft, clean sponge, and then rinse thoroughly with clean water. Use a toothbrush or bottlebrush for hard-to-reach areas. Stubborn dirt and insects will come off more easily if the area is covered with a wet cloth for a few minutes before cleaning. Use the special sponge, which is included in the plastic bag containing the owner's manual, to clean the muffler and to remove any discoloration from it.

After riding in the rain, near the sea or on salt-sprayed roads

Since sea salt or salt sprayed on roads during winter are extremely corrosive in combination with water, carry out the following steps after each ride in the rain, near the sea or on salt-sprayed roads.

**NOTE:** \_\_\_\_\_  
Salt sprayed on roads in the winter may remain well into spring.

1. Clean the motorcycle with cold water and a mild detergent, after the engine has cooled down.

ECA00012

**CAUTION:** \_\_\_\_\_  
**Do not use warm water since it increases the corrosive action of the salt.**

2. Apply a corrosion protection spray on all metal, including chrome- and nickel-plated, surfaces to prevent corrosion.

# MOTORCYCLE CARE AND STORAGE

---

---

## After cleaning

1. Dry the motorcycle with a chamois or an absorbing cloth.
2. Immediately dry the drive chain and lubricate it to prevent it from rusting.
3. Use a chrome polish to shine chrome, aluminum and stainless-steel parts, including the exhaust system. (Even the thermally induced discoloring of stainless-steel exhaust systems can be removed through polishing.)
4. To prevent corrosion, it is recommended to apply a corrosion protection spray on all metal, including chrome- and nickel-plated, surfaces.
5. Use spray oil as a universal cleaner to remove any remaining dirt.
6. Touch up minor paint damage caused by stones, etc.
7. Wax all painted surfaces.
8. Let the motorcycle dry completely before storing or covering it.

EWA00001

### **WARNING**

- **Make sure that there is no oil or wax on the brakes or tires. If necessary, clean the brake discs and brake linings with a regular brake disc cleaner or acetone, and wash the tires with warm water and a mild detergent.**
  - **Before operating the motorcycle test its braking performance and cornering behavior.**
- 

ECA00013

### **CAUTION:**

- **Apply spray oil and wax sparingly and make sure to wipe off any excess.**
  - **Never apply oil or wax to any rubber and plastic parts, but treat them with a suitable care product.**
  - **Avoid using abrasive polishing compounds as they will wear away the paint.**
- 

### **NOTE:**

Consult a Yamaha dealer for advice on what products to use.

---

# MOTORCYCLE CARE AND STORAGE

## Storage

### Short-term

Always store your motorcycle in a cool, dry place and, if necessary, protect it against dust with a porous cover.

ECA00014

### CAUTION:

- **Storing the motorcycle in a poorly ventilated room or covering it with a tarp, while it is still wet, will allow water and humidity to seep in and cause rust.**
- **To prevent corrosion, avoid damp cellars, stables (because of the presence of ammonia) and areas where strong chemicals are stored.**

### Long-term

Before storing your motorcycle for several months:

1. Follow all the instructions in the “Care” section of this chapter.
2. For motorcycles equipped with a fuel cock that has an “OFF” position: Turn the fuel cock lever to “OFF”.
3. Drain the carburetor float chamber by loosening the drain bolt; this will prevent fuel deposits from building up. Pour the drained fuel into the fuel tank.
4. Fill up the fuel tank and add fuel stabilizer (if available) to prevent the fuel tank from rusting and the fuel from deteriorating.
5. Perform the following steps to protect the cylinder, piston rings, etc. from corrosion.

- a. Remove the spark plug caps and spark plugs.
- b. Pour a teaspoonful of engine oil into each spark plug bore.
- c. Install the spark plug caps onto the spark plugs, and then place the spark plugs on the cylinder head so that the electrodes are grounded. (This will limit sparking during the next step.)
- d. Turn the engine over several times with the starter. (This will coat the cylinder walls with oil.)
- e. Remove the spark plug caps from the spark plugs, and then install the spark plugs and the spark plug caps.

EWA00003

### **WARNING**

**To prevent damage or injury from sparking, make sure to ground the spark plug electrodes while turning the engine over.**

# MOTORCYCLE CARE AND STORAGE

---

---

6. Lubricate all control cables and the pivoting points of all levers and pedals as well as of the sidestand/centerstand.
7. Check and, if necessary, correct the tire air pressure, and then lift the motorcycle so that both of its wheels are off the ground. Alternatively, turn the wheels a little every month in order to prevent the tires from becoming degraded in one spot.
8. Cover the muffler outlet with a plastic bag to prevent moisture from entering it.
9. Remove the battery and fully charge it. Store it in a cool, dry place and charge it once a month. Do not store the battery in an excessively cold or warm place (less than 0 °C or more than 30 °C). For more information on storing the battery, see page 6-37.

**NOTE:** \_\_\_\_\_  
Make any necessary repairs before  
storing the motorcycle.  
\_\_\_\_\_



Specifications ..... 8-1  
Conversion table ..... 8-5

## Specifications

|   |   |
|---|---|
| <b>Model</b>                                      | <b>YZF-R6</b>   |
| <b>Dimensions</b>                                 |   |
| Overall length                                    | 2,025 mm (except for N, S, SF)<br>2,080 mm (for N, S, SF) |
| Overall width                                     | 690 mm  |
| Overall height                                    | 1,105 mm  |
| Seat height                                       | 820 mm  |
| Wheelbase   | 1,380 mm  |
| Ground clearance                                  | 135 mm  |
| Minimum turning radius                            | 3,400 mm  |
| <b>Basic weight (with oil and full fuel tank)</b> | <b>186 kg</b>   |
| <b>Engine</b>                                     |   |
| Engine type                                       | Liquid-cooled 4-stroke, DOHC                              |
| Cylinder arrangement                              | Forward-inclined parallel 4-cylinder                      |
| Displacement                                      | 600 cm <sup>3</sup>                                       |
| Bore × stroke                                     | 65.5 × 44.5 mm  |
| Compression ratio                                 | 12.4:1  |
| Starting system                                   | Electric starter  |
| Lubrication system                                | Wet sump  |

## Engine oil

### Type

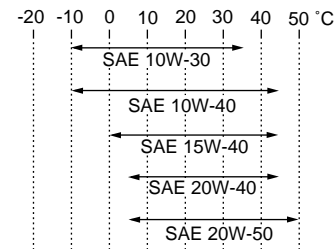

Recommended engine oil classification

API Service SE, SF, SG type or higher

### CAUTION:

**Be sure to use motor oils that do not contain anti-friction modifiers. Passenger car motor oils (often labeled "ENERGY CONSERVING II") contain anti-friction additives which will cause clutch and/or starter clutch slippage, resulting in reduced component life and poor engine performance.**

### Quantity

|  |       |
|--|-------|
| Without oil filter cartridge replacement | 2.5 L |
| With oil filter cartridge replacement    | 2.7 L |
| Total amount (dry engine)                | 3.5 L |

|   |                           |
|---|---------------------------|
| <b>Cooling system capacity (total amount)</b> | 2.15 L                    |
| <b>Air filter</b>                             | Wet type element          |
| <b>Fuel</b>                                   |                           |
| Type  | Regular unleaded gasoline |
| Fuel tank capacity                            | 17 L                      |
| Fuel reserve amount                           | 3.5 L                     |
| <b>Carburetor</b>                             |                           |
| Manufacturer                                  | KEIHIN                    |
| Model × quantity                              | CVRD37 × 4                |
| <b>Spark plug</b>                             |                           |
| Manufacturer/model                            | NGK / CR10EK              |
| Gap   | 0.6–0.7 mm                |
| <b>Clutch type</b>                            | Wet, multiple-disc        |
| <b>Transmission</b>                           |                           |
| Primary reduction system                      | Spur gear                 |
| Primary reduction ratio                       | 1.955                     |
| Secondary reduction system                    | Chain drive               |
| Secondary reduction ratio                     | 3.000                     |
| Transmission type                             | Constant-mesh 6-speed     |
| Operation                                     | Left foot                 |

|                   |     |       |
|-------------------|-----|-------|
| <b>Gear ratio</b> |     |       |
|                   | 1st | 2.846 |
|                   | 2nd | 1.947 |
|                   | 3rd | 1.556 |
|                   | 4th | 1.333 |
|                   | 5th | 1.190 |
|                   | 6th | 1.083 |

## Chassis

|              |         |
|--------------|---------|
| Frame type   | Diamond |
| Caster angle | 24°     |
| Trail        | 81 mm   |

## Tires

|                    |                          |  |
|--------------------|--------------------------|--|
| <b>Front</b>       |                          |  |
| Type               | Tubeless tire            |  |
| Size               | 120/60 ZR17 (55 W)       |  |
| Manufacturer/model | MICHELIN / Pilot SPORT B |  |
|                    | Dunlop / D207FJ          |  |
| <b>Rear</b>        |                          |  |
| Type               | Tubeless tire            |  |
| Size               | 180/55 ZR17 (73 W)       |  |
| Manufacturer/model | MICHELIN / Pilot SPORT B |  |
|                    | Dunlop / D207N           |  |
| Maximum load*      | 189 kg                   |  |

# SPECIFICATIONS

Tire air pressure  
(measured on cold tires)

Up to 90 kg\*

Front 250 kPa (2.50 kg/cm<sup>2</sup>, 2.50 bar)

Rear 250 kPa (2.50 kg/cm<sup>2</sup>, 2.50 bar)

90 kg–maximum\*

Front 250 kPa (2.50 kg/cm<sup>2</sup>, 2.50 bar)

Rear 290 kPa (2.90 kg/cm<sup>2</sup>, 2.90 bar)

High-speed riding\*

Front 250 kPa (2.50 kg/cm<sup>2</sup>, 2.50 bar)

Rear 250 kPa (2.50 kg/cm<sup>2</sup>, 2.50 bar)

\* Total weight of rider, passenger, cargo and accessories

## Wheels

Front

Type Cast wheel

Size 17 × MT 3.50

Rear

Type Cast wheel

Size 17 × MT 5.50

## Brakes

Front

Type Dual disc brake

Operation Right hand

Fluid DOT 4

Rear

Type Single disc brake

Operation Right foot

Fluid DOT 4

## Suspension

Front Telescopic fork

Rear Swingarm (link suspension)

## Spring/shock absorber

Front Coil spring / oil damper

Rear Coil spring / gas-oil damper

## Wheel travel

Front 130 mm

Rear 120 mm

## Electrical system

Ignition system DC-C.D.I.

Charging system

Type A.C. magneto

Standard output 14 V, 320 W@ 5,000 r/min

Battery

Model GT9B-4

Voltage, capacity 12 V, 8 AH

## Headlight type

Quartz bulb (halogen)

**Bulb voltage, wattage × quantity**

|   |                           |
|---|---------------------------|
| Headlight                                   | 12 V, 60/55 W × 2         |
| Tail/brake light                            | 13.5 V, 1/6.1 W × 2 (LED) |
| Turn signal light                           | 12 V, 21 W × 4            |
| Auxiliary light                             | 12 V, 5 W × 2             |
| Meter lighting                              | 12 V, 1.4 W × 2           |
| Neutral indicator light                     | LED                       |
| High beam indicator light                   | LED                       |
| Turn signal indicator light                 | LED                       |
| Fuel level warning light                    | LED                       |
| Oil level/coolant temperature warning light | LED                       |

**Fuses**

|                       |       |
|-----------------------|-------|
| Main fuse             | 30 A  |
| Headlight fuse        | 20 A  |
| Signaling system fuse | 15 A  |
| Radiator fan fuse     | 7.5 A |
| Ignition fuse         | 15 A  |
| Odometer fuse         | 7.5 A |

# SPECIFICATIONS

EAU01064

## Conversion table

All specification data in this manual are listed in SI and METRIC UNITS.

Use this table to convert METRIC unit data to IMPERIAL unit data.

Example

| METRIC |   | MULTIPLIER | = | IMPERIAL |
|--------|---|------------|---|----------|
| ** mm  | × | 0.03937    | = | ** in    |
| 2 mm   | × | 0.03937    | = | 0.08 in  |

## Conversion table

| METRIC TO IMPERIAL  |                       |            |                           |
|---------------------|-----------------------|------------|---------------------------|
|                     | Metric unit           | Multiplier | Imperial unit             |
| Torque              | m·kg                  | 7.233      | ft·lb                     |
|                     | m·kg                  | 86.794     | in·lb                     |
|                     | cm·kg                 | 0.0723     | ft·lb                     |
|                     | cm·kg                 | 0.8679     | in·lb                     |
| Weight              | kg                    | 2.205      | lb                        |
|                     | g                     | 0.03527    | oz                        |
| Speed               | km/h                  | 0.6214     | mi/h                      |
| Distance            | km                    | 0.6214     | mi                        |
|                     | m                     | 3.281      | ft                        |
|                     | m                     | 1.094      | yd                        |
|                     | cm                    | 0.3937     | in                        |
|                     | mm                    | 0.03937    | in                        |
| Volume,<br>Capacity | cc (cm <sup>3</sup> ) | 0.03527    | oz (IMP liq.)             |
|                     | cc (cm <sup>3</sup> ) | 0.06102    | cu-in                     |
|                     | L (liter)             | 0.8799     | qt (IMP liq.)             |
|                     | L (liter)             | 0.2199     | gal (IMP liq.)            |
| Miscellaneous       | kg/mm                 | 55.997     | lb/in                     |
|                     | kg/cm <sup>2</sup>    | 14.2234    | psi (lb/in <sup>2</sup> ) |
|                     | Centigrade (°C)       | 9/5 + 32   | Fahrenheit (°F)           |

|                                     |     |
|-------------------------------------|-----|
| Identification numbers .....        | 9-1 |
| Key identification number .....     | 9-1 |
| Vehicle identification number ..... | 9-1 |
| Model label .....                   | 9-2 |

## Identification numbers

EAU02944

Record the key identification number, vehicle identification number and model label information in the spaces provided below for assistance when ordering spare parts from a Yamaha dealer or for reference in case the vehicle is stolen.

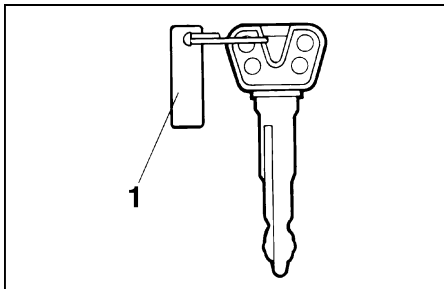

1. Key identification number

1. KEY IDENTIFICATION NUMBER:

2. VEHICLE IDENTIFICATION NUMBER:

3. MODEL LABEL INFORMATION:

EAU01041

## Key identification number

The key identification number is stamped into the key tag. Record this number in the space provided and use it for reference when ordering a new key.

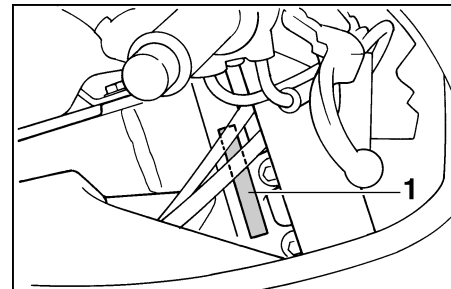

1. Vehicle identification number

EAU01043

## Vehicle identification number

The vehicle identification number is stamped into the steering head pipe. Record this number in the space provided.

### NOTE:

The vehicle identification number is used to identify your motorcycle and may be used to register your motorcycle with the licensing authority in your area.



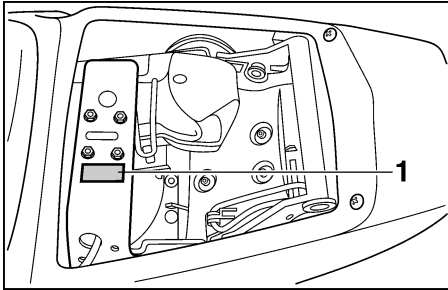

1. Model label

EAU01049

## Model label

The model label is affixed to the location shown in the figure. Record the information on this label in the space provided. This information will be needed when ordering spare parts from a Yamaha dealer.

# INDEX

## A

- Air filter element, checking .....6-17
- Air intake duct .....6-20
- Anti-theft alarm .....3-10

## B

- Battery .....6-37
- Brake and clutch levers, checking and lubricating .....6-34
- Brake fluid, changing .....6-30
- Brake fluid level, checking .....6-29
- Brake lever .....3-9
- Brake light switch (rear), adjusting .....6-27
- Brake pads, checking .....6-28
- Brake pedal .....3-10
- Brake pedal, lubricating .....6-34
- Brake pedal position, adjusting .....6-27

## C

- Cables, checking and lubricating .....6-33
- Carburetors, adjusting .....6-20
- Care .....7-1
- Clutch lever .....3-9
- Clutch lever free play, adjusting .....6-25
- Conversion table .....8-5
- Coolant .....6-13
  - Changing .....6-15
  - Checking .....6-13
- Cowlings and panels, removing and installing .....6-6

## D

- Dimmer switch .....3-7
- Drive chain, lubricating .....6-32

- Drive chain slack .....6-31
  - Adjusting .....6-31
  - Checking .....6-31

## E

- Engine break-in .....5-4
- Engine oil and oil filter cartridge .....6-10
- Engine stop switch .....3-8

## F

- Front and rear suspension settings .....3-21
- Front fork, adjusting .....3-17
- Front fork, checking .....6-35
- Fuel .....3-11
  - Fuel consumption, tips for reducing .....5-3
  - Fuel level warning light .....3-2
  - Fuel tank breather hose .....3-12
  - Fuel tank cap .....3-11
- Fuses, replacing .....6-38

## H

- Handlebar switches .....3-7
- Headlight bulb, replacing .....6-39
- Helmet holder .....3-15
- High beam indicator light .....3-2
- Horn switch .....3-8

## I

- Identification numbers .....9-1
- Idling speed, adjusting .....6-21
- Ignition circuit cut-off system .....3-23
- Indicator and warning lights .....3-2

## K

- Key identification number .....9-1

## L

- Light switch .....3-8
- Luggage strap holders .....3-22

## M

- Main switch/steering lock .....3-1
- Model label .....9-2

## N

- Neutral indicator light .....3-2

## O

- Oil level/coolant temperature warning light .....3-3

## P

- Parking .....5-4
- Part locations .....2-1
- Pass switch .....3-7
- Periodic maintenance and lubrication chart .....6-3
- Pre-operation check list .....4-1

## S

- Safety information .....1-1
- Seats .....3-13
  - Passenger seat .....3-14
  - Rider seat .....3-13
- Self-diagnosis device .....3-7
- Shifting .....5-3
- Shift pedal .....3-9
- Shock absorber assembly, adjusting .....3-19
- Sidestand .....3-22
- Sidestand, checking and lubricating .....6-34
- Spark plugs, checking .....6-9

|                                      |      |
|--------------------------------------|------|
| Specifications .....                 | 8-1  |
| Speedometer unit .....               | 3-5  |
| Starter (choke) lever .....          | 3-13 |
| Starting a cold engine .....         | 5-1  |
| Starting a warm engine .....         | 5-2  |
| Start switch .....                   | 3-8  |
| Steering, checking .....             | 6-36 |
| Storage .....                        | 7-4  |
| Storage compartment .....            | 3-15 |
| Supporting the motorcycle .....      | 6-41 |
| Suspension (rear), lubricating ..... | 6-35 |

## T

|  |      |
|--|------|
| Tachometer .....   | 3-6  |
| Tail/brake light .....                                     | 6-40 |
| Throttle cable free play, adjusting .....                  | 6-21 |
| Throttle grip and cable, checking and<br>lubricating ..... | 6-33 |
| Tires .....  | 6-22 |
| Tool kit .....   | 6-1  |
| Troubleshooting .....                                      | 6-44 |
| Troubleshooting charts .....                               | 6-45 |
| Turn signal indicator light .....                          | 3-2  |
| Turn signal light bulb, replacing .....                    | 6-40 |
| Turn signal switch .....                                   | 3-8  |

## V

|                                     |      |
|-------------------------------------|------|
| Valve clearance, adjusting .....    | 6-22 |
| Vehicle identification number ..... | 9-1  |

## W

|                                |      |
|--------------------------------|------|
| Wheel bearings, checking ..... | 6-36 |
| Wheel (Front) .....            | 6-41 |
| Installing .....               | 6-42 |
| Removing .....                 | 6-41 |
| Wheel (rear) .....             | 6-43 |
| Installing .....               | 6-44 |
| Removing .....                 | 6-43 |
| Wheels .....                   | 6-25 |







PRINTED ON RECYCLED PAPER

PRINTED IN JAPAN  
2000-9-0.3×2 CR  
(E)