



- ⚠ Read this manual carefully before operating this vehicle.
- ⚠ Il convient de lire attentivement ce manuel avant la première utilisation du véhicule.
- ⚠ Bitte lesen Sie diese Bedienungsanleitung sorgfältig durch, bevor Sie das Fahrzeug in Betrieb nehmen.

**OWNER'S MANUAL
MANUEL DU PROPRIÉTAIRE
BEDIENUNGSANLEITUNG**

PW

50

PW50(A1)

5PG-28199-8A



PRINTED ON RECYCLED PAPER
IMPRIMÉ SUR PAPIER RECYCLÉ
AUF RECYCLINGPAPIER GEDRUCKT

PRINTED IN JAPAN
2010.04-0.7×1 CR
(E,F,G)



 Read this manual carefully before operating this vehicle.

OWNER'S MANUAL

PW

50

PW50(A1)

5PG-28199-8A-E0

 **Read this manual carefully before operating this vehicle. This manual should stay with this vehicle if it is sold.**

EC Declaration of Conformity

conforming to Directive 2006/42/EC

**We, YAMAHA MOTOR CO., LTD. 2500 Shingai, Iwata, Japan,
declare in sole responsibility, that the product**

PW50 (JYA3PT00000428026-)

(Make, model)

**to which this declaration applies, conforms to the essential health
and safety requirements of Directive 2006/42/EC**

(If applicable)

**and to the other relevant Directives of EEC
2004/108/EC**

(Title and/or number and date of issue of the other Directives of EEC)

(If applicable)

**To effect correct application of the essential health and safety requirements
stated in the Directives of EEC, the following-standards and/or technical
specifications were consulted:**

--

(Title and/or number and date of issue of standards and/or specifications)

Authorized Representative

YAMAHA MOTOR EUROPE N.V.

Koolhovenlaan 101, 1119 NC Schiphol-Rijk, The Netherlands

Signature



Kunihiko Miwa

Executive Officer
Commuter Vehicle Section
Engineering Section
Motorcycle Business Operation
YAMAHA MOTOR CO., LTD.

Date of Issue 4 March, 2010

Congratulations on your purchase of the Yamaha PW50(A1). This model is the result of Yamaha's vast experience in the production of fine sporting, touring, and pacesetter racing machines. It represents the high degree of craftsmanship and reliability that have made Yamaha a leader in these fields.

This manual will give you an understanding of the operation, inspection, and basic maintenance of this motorcycle. If you have any questions concerning the operation or maintenance of your motorcycle, please consult a Yamaha dealer.

The design and manufacture of this Yamaha motorcycle fully comply with the emissions standards for clean air applicable at the date of manufacture. Yamaha has met these standards without reducing the performance or economy of operation of the motorcycle. To maintain these high standards, it is important that you and your Yamaha dealer pay close attention to the recommended maintenance schedules and operating instructions contained within this manual.

Yamaha continually seeks advancements in product design and quality. Therefore, while this manual contains the most current product information available at the time of printing, there may be minor discrepancies between your motorcycle and this manual. If there is any question concerning this manual, please consult a Yamaha dealer.

 WARNING

Please read this manual carefully and completely before operating this motorcycle.

 WARNING

This motorcycle is designed and manufactured for off-road use only. It is illegal to operate this motorcycle on any public street, road or highway. Such use is prohibited by law. This motorcycle complies with almost all state off-highway noise level and spark arrester laws and regulations. Please check your local riding laws and regulations before operating this motorcycle.

AN IMPORTANT SAFETY MESSAGE:

- Read this manual carefully and completely before operating this motorcycle. Make sure you understand all instructions.
- Pay close attention to the warning and notice labels on the motorcycle.
- Never operate a motorcycle without proper training or instruction.
- Weight of the rider should not exceed 25 kg (55 lb).

INTRODUCTION

AN IMPORTANT NOTE TO PARENTS:

This motorcycle is not a toy. Before you let your child ride this motorcycle, you should understand the instructions and warnings in this Owner's Manual. Then be sure your child understands and will follow them. Children differ in skills, physical abilities, and judgment. Some children may not be able to operate a motorcycle safely. Parents should supervise their child's use of the motorcycle at all times. Parents should permit continued use only if they determine that the child has the ability to operate the motorcycle safely.

Your motorcycle is equipped with an adjustable speed limiter and a power reduction plate. Yamaha recommends that all beginners start off with the speed limiter adjusting screw turned in and the power reduction plate installed in the exhaust manifold to limit the power available while they learn. The limiter screw may be gradually turned out to increase maximum speed as the beginner becomes more familiar with operating the motorcycle. Parents should decide when to adjust the motorcycle for more power as their youngster's riding skills improve. Once the rider can operate with skill at the top speed permitted by adjusting the speed limiter alone, the power reduction plate can be removed. Since removal of this plate will result in a significant increase in power, turn the speed limiter back in again; adjust it out in stages as you did before.

Motorcycles are single track vehicles. Their safe use and operation are dependent upon the use of proper riding techniques as well as the expertise of the operator. Every operator should know the following requirements before riding this motorcycle.



He or she should:

- Obtain thorough instructions from a competent source on all aspects of motorcycle operation.
- Observe the warnings and maintenance requirements in this Owner's Manual.
- Obtain qualified training in safe and proper riding techniques.
- Obtain professional technical service as indicated in this Owner's Manual and/or when made necessary by mechanical conditions.

IMPORTANT MANUAL INFORMATION

EAU10132

Particularly important information is distinguished in this manual by the following notations:

	This is the safety alert symbol. It is used to alert you to potential personal injury hazards. Obey all safety messages that follow this symbol to avoid possible injury or death.
 WARNING	A WARNING indicates a hazardous situation which, if not avoided, could result in death or serious injury.
NOTICE	A NOTICE indicates special precautions that must be taken to avoid damage to the vehicle or other property.
TIP	A TIP provides key information to make procedures easier or clearer.

IMPORTANT MANUAL INFORMATION

EAU10200

**PW50(A1)
OWNER'S MANUAL
©2010 by Yamaha Motor Co., Ltd.
1st edition, March 2010
All rights reserved.
Any reprinting or unauthorized use
without the written permission of
Yamaha Motor Co., Ltd.
is expressly prohibited.
Printed in Japan.**

TABLE OF CONTENTS

LOCATION OF IMPORTANT LABELS	1-1	FOR YOUR SAFETY – PRE-OPERATION CHECKS	5-1	Checking the throttle cable free play	7-12
SAFETY INFORMATION	2-1	OPERATION AND IMPORTANT RIDING POINTS	6-1	Tires	7-12
DESCRIPTION	3-1	Starting and warming up a cold engine	6-1	Panel wheels	7-13
Left view	3-1	Starting a warm engine	6-1	Adjusting the front and rear brake lever free play	7-14
Right view	3-2	Starting off	6-2	Checking the front and rear brake shoes	7-15
Controls and instruments	3-3	Acceleration and deceleration	6-2	Checking and lubricating the cables	7-15
INSTRUMENT AND CONTROL FUNCTIONS	4-1	Braking	6-2	Checking and lubricating the throttle grip and cable	7-16
Handlebar switch	4-1	Engine break-in	6-3	Adjusting the Autolube pump	7-16
Speed limiter and power reduction plate	4-1	Parking	6-4	Lubricating the front and rear brake levers	7-16
Front brake lever	4-2	PERIODIC MAINTENANCE AND ADJUSTMENT	7-1	Checking and lubricating the centerstand	7-17
Rear brake lever	4-3	Owner's tool kit	7-2	Checking the front fork	7-17
Fuel tank cap	4-3	Periodic maintenance chart for the emission control system	7-3	Checking the steering	7-18
Fuel	4-3	General maintenance and lubrication chart	7-4	Checking the wheel bearings	7-18
Fuel tank breather hose	4-5	Checking the spark plug	7-6	Front wheel	7-18
2-stroke engine oil	4-5	Removing the power reduction plate	7-7	Rear wheel	7-20
Fuel cock	4-6	Transmission oil	7-8	Troubleshooting	7-23
Starter (choke) lever	4-6	Middle and final gear cases	7-9	Troubleshooting chart	7-24
Kickstarter	4-7	Cleaning the air filter element	7-9	MOTORCYCLE CARE AND STORAGE	8-1
Seat	4-7	Cleaning the spark arrester	7-10	Matte color caution	8-1
		Adjusting the carburetor	7-11	Care	8-1
		Adjusting the engine idling speed	7-11	Storage	8-3

TABLE OF CONTENTS

SPECIFICATIONS9-1

CONSUMER INFORMATION.....10-1

 Identification numbers10-1

LOCATION OF IMPORTANT LABELS

EAU48114

Read and understand all of the labels on your vehicle. They contain important information for safe and proper operation of your vehicle. Never remove any labels from your vehicle. If a label becomes difficult to read or comes off, a replacement label is available from your Yamaha dealer.

For Canada

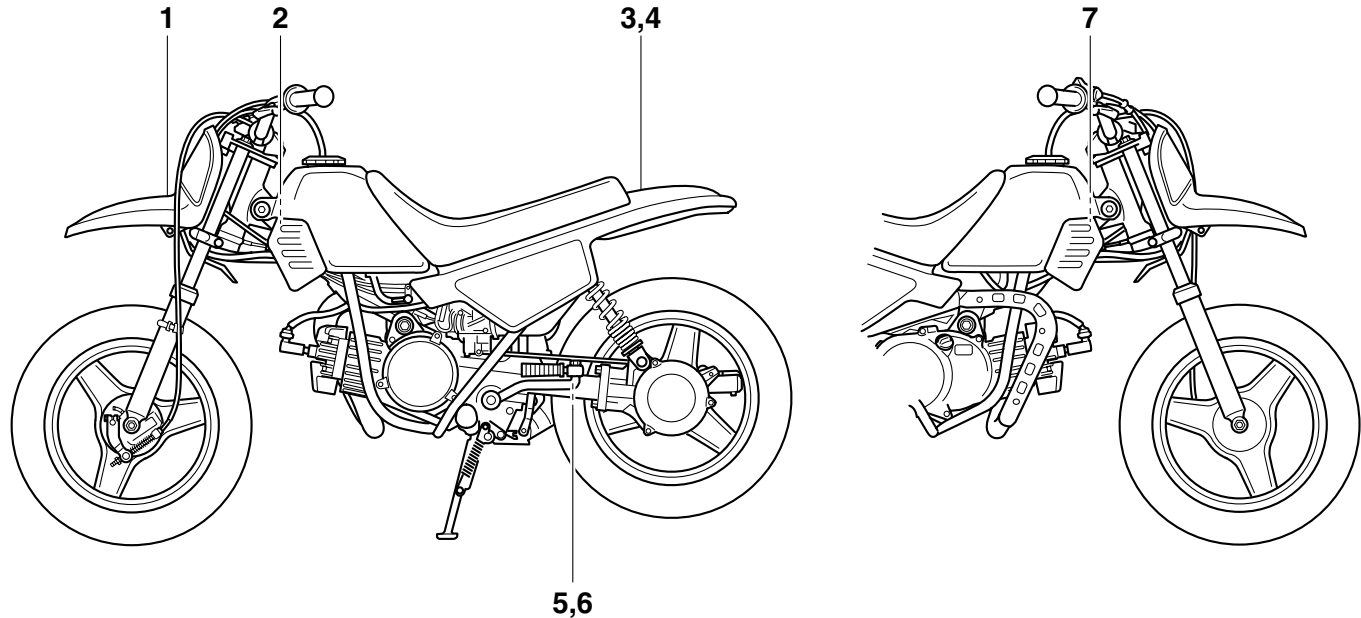

LOCATION OF IMPORTANT LABELS

For Canada

1

1

▲ WARNING

- **BEFORE YOU OPERATE THIS VEHICLE, READ THE OWNER'S MANUAL AND ALL LABELS.**
- **NEVER CARRY A PASSENGER.** You increase your risk of losing control if you carry a passenger.
- **NEVER OPERATE THIS VEHICLE ON PUBLIC ROADS.** You can collide with another vehicle if you operate this vehicle on a public road.
- **ALWAYS WEAR AN APPROVED MOTORCYCLE HELMET,** eye protection, and protective clothing.

3PT-2118K-A1

2



3

▲ AVERTISSEMENT

- **LIRE LE MANUEL DU PROPRIÉTAIRE AINSI QUE TOUTES LES ÉTIQUETTES AVANT D'UTILISER CE VÉHICULE.**
- **NE JAMAIS TRANSPORTER DE PASSAGER.** La conduite avec passager augmente les risques de perte de contrôle.
- **NE JAMAIS ROULER SUR DES CHEMINS PUBLICS.** Vous pourriez entrer en collision avec un autre véhicule.
- **TOUJOURS PORTER UN CASQUE DE MOTOCYCLISTE APPROUVÉ,** des lunettes et des vêtements de protection.

5PG-2118K-10

4

THIS VEHICLE IS A RESTRICTED USE MOTORCYCLE AND IS NOT INTENDED FOR USE ON PUBLIC HIGHWAYS.

CE VÉHICULE EST UNE MOTOCYCLETTE À USAGE RESTREINT DONT L'USAGE N'EST PAS DESTINÉ AUX VOIES PUBLIQUES.

3PT-2416E-10

LOCATION OF IMPORTANT LABELS

For Canada

5

TIRE INFORMATION

Cold tire normal pressure should be set as follows.

FRONT : 100 kPa, {1.00 kgf/cm²}, 15 psi

REAR : 100 kPa, {1.00 kgf/cm²}, 15 psi

3RV-21668-A0

6

INFORMATION SUR LES PNEUS

La pression des pneus à froid doit normalement être réglée comme suit.

AVANT : 100 kPa, {1.00 kgf/cm²}, 15 psi

ARRIERE: 100 kPa, {1.00 kgf/cm²}, 15 psi

3RV-21668-B0

7

This spark ignition system meets all requirements of the Canadian Interference Causing Equipment Regulations.

Ce système d'allumage par étincelle de véhicule respecte toutes les exigences du Règlement sur le matériel brouilleur du Canada.

3JK-82377-00

1

LOCATION OF IMPORTANT LABELS

For Europe

1

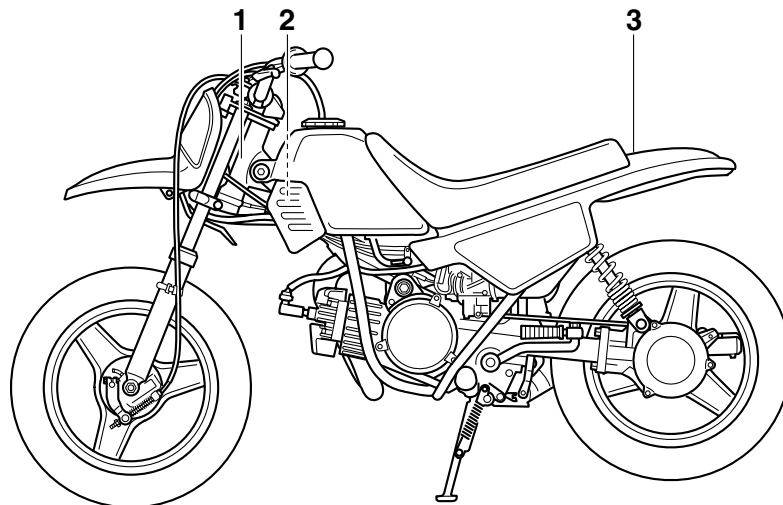

LOCATION OF IMPORTANT LABELS

For Europe

1

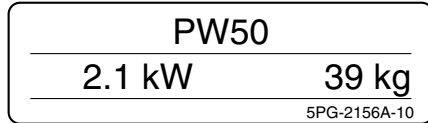

2



3

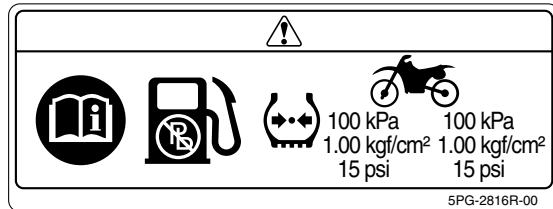

1

LOCATION OF IMPORTANT LABELS

Familiarize yourself with the following pictograms and read the explanatory text.

1



Read the Owner's manual.



Use unleaded gasoline only.



This unit contains high-pressure nitrogen gas. Mishandling can cause an explosion. Do not incinerate, puncture or open.

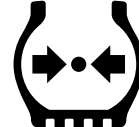

Measure the tire pressure when the tires are cold.

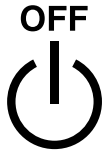

Turn off the main switch after riding to avoid draining the battery.



Adjust the tire pressure. Improper tire pressure can cause loss of control. Loss of control can result in severe injury or death.

**.* kPa **.* kPa
*** kgf/cm² *** kgf/cm²
. psi *.* psi

LOCATION OF IMPORTANT LABELS

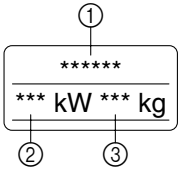
 <p>① ***** *** kW *** kg ② ③</p>	<ul style="list-style-type: none">① Model Name② Max. Power③ Mass In Running Order
---	---

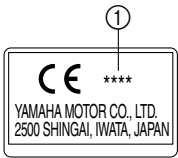
 <p>① **** CE YAMAHA MOTOR CO., LTD. 2500 SHINGAI, IWATA, JAPAN</p>	<ul style="list-style-type: none">① Year of construction
--	--

LOCATION OF IMPORTANT LABELS

For Oceania and South Africa

1

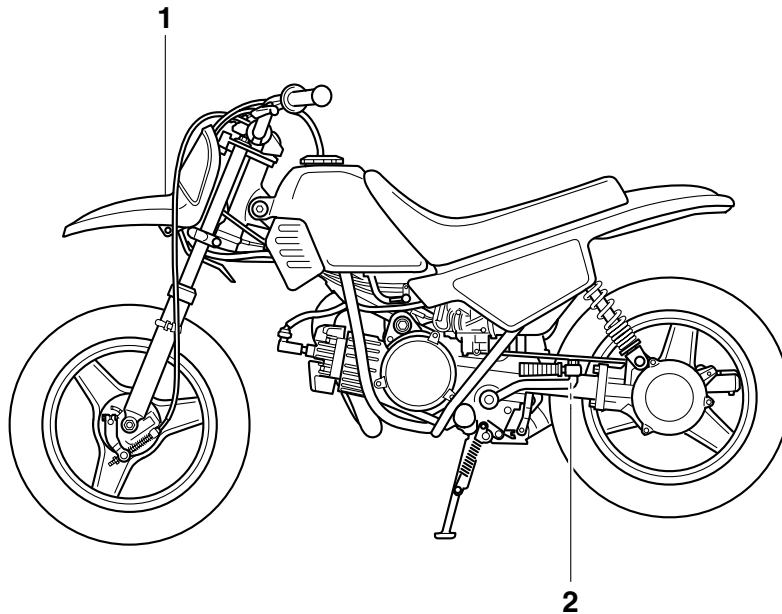

LOCATION OF IMPORTANT LABELS

For Oceania and South Africa

1

⚠ WARNING

- **BEFORE YOU OPERATE THIS VEHICLE, READ THE OWNER'S MANUAL AND ALL LABELS.**
- **NEVER CARRY A PASSENGER.** You increase your risk of losing control if you carry a passenger.
- **NEVER OPERATE THIS VEHICLE ON PUBLIC ROADS.** You can collide with another vehicle if you operate this vehicle on a public road.
- **ALWAYS WEAR AN APPROVED MOTORCYCLE HELMET,** eye protection, and protective clothing.

3PT-2118K-A1

2

TIRE INFORMATION

Cold tire normal pressure should be set as follows.

FRONT : 100 kPa, {1.00 kgf/cm²}, 15 psi

REAR : 100 kPa, {1.00 kgf/cm²}, 15 psi

3RV-21668-A0

1

Be a Responsible Owner

As the vehicle's owner, you are responsible for the safe and proper operation of your motorcycle.

Motorcycles are single-track vehicles. Their safe use and operation are dependent upon the use of proper riding techniques as well as the expertise of the operator. Every operator should know the following requirements before riding this motorcycle.

He or she should:

- Obtain thorough instructions from a competent source on all aspects of motorcycle operation.
- Observe the warnings and maintenance requirements in this Owner's Manual.
- Obtain qualified training in safe and proper riding techniques.
- Obtain professional technical service as indicated in this Owner's Manual and/or when made necessary by mechanical conditions.

Safe Riding

Perform the pre-operation checks each time you use the vehicle to make sure it is in safe operating condition. Failure to inspect or maintain the vehicle properly increases the possibility of an accident or equipment damage. See page 5-1 for a list of pre-operation checks.

- This motorcycle is designed for off-road use only, therefore, it is illegal to operate it on public streets, roads, or highways, even a dirt or gravel one. Off-road use on public lands may be illegal. Please check local regulations before riding.
- This motorcycle is designed to carry the operator only. No passengers.
- The failure of motorists to detect and recognize motorcycles in traffic is the predominating cause of automobile/motorcycle accidents. Many accidents have been caused by an automobile driver who did not see the motorcycle. Making

yourself conspicuous appears to be very effective in reducing the chance of this type of accident.

Therefore:

- Wear a brightly colored jacket.
- Use extra caution when you are approaching and passing through intersections, since intersections are the most likely places for motorcycle accidents to occur.
- Ride where other motorists can see you. Avoid riding in another motorist's blind spot.
- Many accidents involve inexperienced operators.
- Make sure that you are qualified and that you only lend your motorcycle to other qualified operators.
- Know your skills and limits. Staying within your limits may help you to avoid an accident.
- We recommend that you practice riding your motorcycle until you have become thoroughly familiar with the motorcycle and all of its controls.

- Many accidents have been caused by error of the motorcycle operator. A typical error made by the operator is veering wide on a turn due to excessive speed or undercornering (insufficient lean angle for the speed). Never travel faster than warranted by conditions.
- Ride cautiously in unfamiliar areas. You may encounter hidden obstacles that could cause an accident.
- The posture of the operator is important for proper control. The operator should keep both hands on the handlebar and both feet on the operator footrests during operation to maintain control of the motorcycle.
- Never ride under the influence of alcohol or other drugs.
- Wear a face shield or goggles. Wind in your unprotected eyes could contribute to an impairment of vision that could delay seeing a hazard.
- The use of a jacket, heavy boots, trousers, gloves, etc., is effective in preventing or reducing abrasions or lacerations.
- Never wear loose-fitting clothes, otherwise they could catch on the control levers, footrests, or wheels and cause injury or an accident.
- Always wear protective clothing that covers your legs, ankles, and feet. The engine or exhaust system become very hot during or after operation and can cause burns.

Avoid Carbon Monoxide Poisoning

All engine exhaust contains carbon monoxide, a deadly gas. Breathing carbon monoxide can cause headaches, dizziness, drowsiness, nausea, confusion, and eventually death.

Carbon Monoxide is a colorless, odorless, tasteless gas which may be present even if you do not see or smell any engine exhaust. Deadly levels of

carbon monoxide can collect rapidly and you can quickly be overcome and unable to save yourself. Also, deadly levels of carbon monoxide can linger for hours or days in enclosed or poorly ventilated areas. If you experience any symptoms of carbon monoxide poisoning, leave the area immediately, get fresh air, and **SEEK MEDICAL TREATMENT.**

- Do not run engine indoors. Even if you try to ventilate engine exhaust with fans or open windows and doors, carbon monoxide can rapidly reach dangerous levels.
- Do not run engine in poorly ventilated or partially enclosed areas such as barns, garages, or carports.
- Do not run engine outdoors where engine exhaust can be drawn into a building through openings such as windows and doors.

Loading

Adding accessories to your motorcycle can adversely affect stability and handling if the weight distribution of the motorcycle is changed. To avoid the

Protective Apparel

The majority of fatalities from motorcycle accidents are the result of head injuries. The use of a safety helmet is the single most critical factor in the prevention or reduction of head injuries.

- Always wear an approved helmet.

SAFETY INFORMATION

2

possibility of an accident, use extreme caution when adding accessories to your motorcycle. Use extra care when riding a motorcycle that has added accessories. Here are some general guidelines to follow if adding accessories to your motorcycle:

Operation of an overloaded vehicle could cause an accident.

- The weight of the operator must not exceed 25 kg (55 lb).
- Accessory weight should be kept as low and close to the motorcycle as possible. Securely pack your heaviest items as close to the center of the vehicle as possible and make sure to distribute the weight as evenly as possible on both sides of the motorcycle to minimize imbalance or instability.
- Shifting weights can create a sudden imbalance. Make sure that accessories are securely attached to

the motorcycle before riding. Check accessory mounts frequently.

- Properly adjust the suspension for your load (suspension-adjustable models only), and check the condition and pressure of your tires.
- Never attach any large or heavy items to the handlebar, front fork, or front fender.

Genuine Yamaha Accessories

Choosing accessories for your vehicle is an important decision. Genuine Yamaha accessories, which are available only from a Yamaha dealer, have been designed, tested, and approved by Yamaha for use on your vehicle.

Many companies with no connection to Yamaha manufacture parts and accessories or offer other modifications for Yamaha vehicles. Yamaha is not in a position to test the products that these aftermarket companies produce. Therefore, Yamaha can neither endorse nor recommend the use of accessories not sold by Yamaha or

modifications not specifically recommended by Yamaha, even if sold and installed by a Yamaha dealer.

Aftermarket Parts, Accessories, and Modifications

While you may find aftermarket products similar in design and quality to genuine Yamaha accessories, recognize that some aftermarket accessories or modifications are not suitable because of potential safety hazards to you or others. Installing aftermarket products or having other modifications performed to your vehicle that change any of the vehicle's design or operation characteristics can put you and others at greater risk of serious injury or death. You are responsible for injuries related to changes in the vehicle.

Keep the following guidelines in mind, as well as those provided under "Loading" when mounting accessories.

- Never install accessories that would impair the performance of your motorcycle. Carefully inspect the accessory before using it to make sure that it does not in any way reduce ground clearance or

cornering clearance, limit suspension travel, steering travel or control operation.

- Accessories fitted to the handlebar or the front fork area can create instability due to improper weight distribution. If accessories are added to the handlebar or front fork area, they must be as lightweight as possible and should be kept to a minimum.
- Bulky or large accessories may seriously affect the stability of the motorcycle. Wind may attempt to lift the motorcycle, or the motorcycle may become unstable in cross winds.
- Certain accessories can displace the operator from his or her normal riding position. This improper position limits the freedom of movement of the operator and may limit control ability, therefore, such accessories are not recommended.
- Use caution when adding electrical accessories. If electrical accessories exceed the capacity of the motorcycle's electrical system, an

electric failure could result, which could cause a dangerous loss of lights or engine power.

Aftermarket Tires and Rims

The tires and rims that came with your motorcycle were designed to match the performance capabilities and to provide the best combination of handling, braking, and comfort. Other tires, rims, sizes, and combinations may not be appropriate. Refer to page 7-12 for tire specifications and more information on replacing your tires.

Transporting the motorcycle

Be sure to observe following instructions before transporting the motorcycle in another vehicle.

- Remove all loose items from the motorcycle.
- Check that the fuel cock (if equipped) is in the "OFF" position and that there are no fuel leaks.
- Point the front wheel straight ahead on the trailer or in the truck bed, and choke it in a rail to prevent movement.

- Shift the transmission in gear (for models with a manual transmission).
- Secure the motorcycle with tie-downs or suitable straps that are attached to solid parts of the motorcycle, such as the frame or upper front fork triple clamp (and not, for example, to rubber-mounted handlebars or turn signals, or parts that could break). Choose the location for the straps carefully so the straps will not rub against painted surfaces during transport.
- The suspension should be compressed somewhat by the tie-downs, if possible, so that the motorcycle will not bounce excessively during transport.

DESCRIPTION

EAU10410

Left view

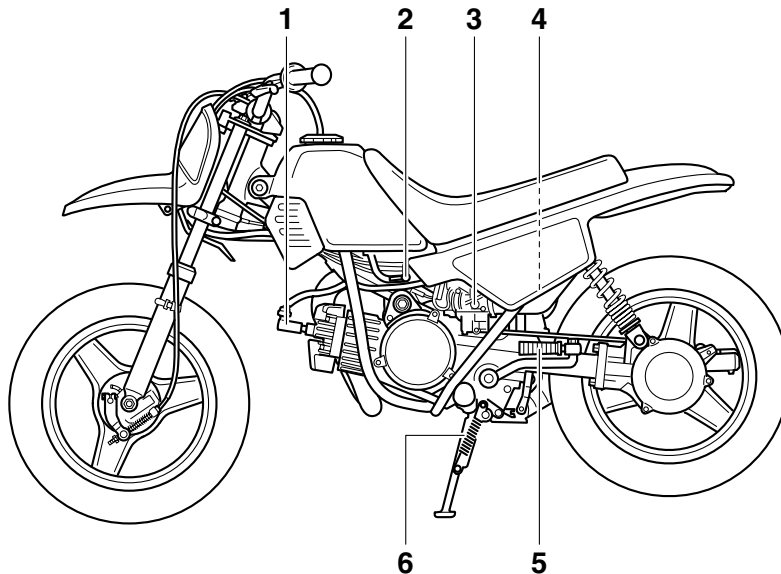

1. Spark plug (page 7-6)
2. Fuel cock (page 4-6)
3. Throttle stop screw (page 7-11)
4. Air filter element (page 7-9)
5. Kickstarter (page 4-7)
6. Centerstand (page 7-17)

Right view

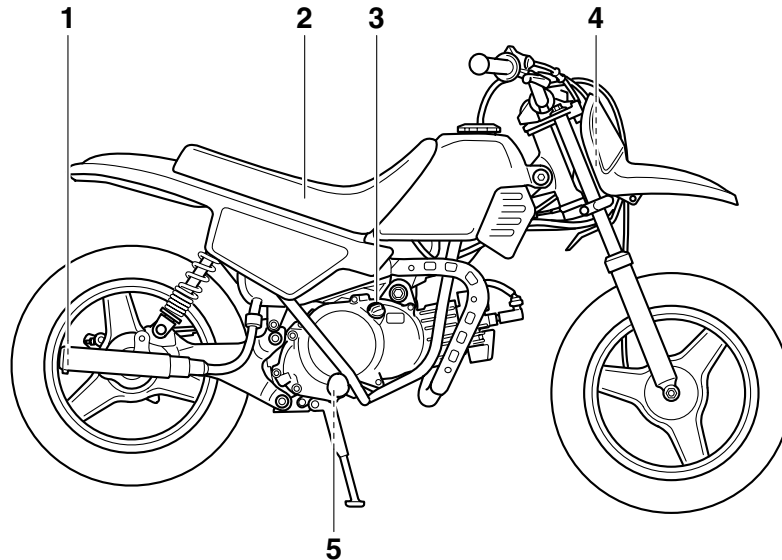

1. Spark arrester (page 7-10)
2. Seat (page 4-7)
3. Transmission oil filler cap (page 7-8)
4. 2-stroke engine oil tank (page 4-5)
5. Transmission oil drain bolt (page 7-8)

DESCRIPTION

EAU10430

Controls and instruments

3

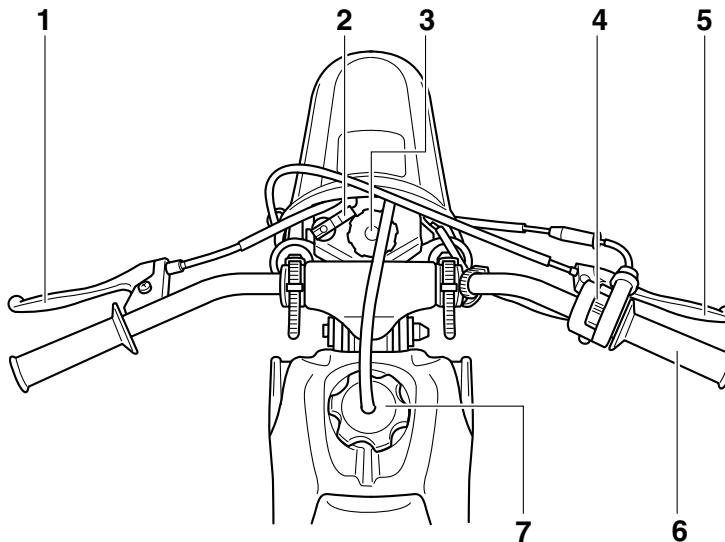

1. Rear brake lever (page 4-3)
2. Starter (choke) lever (page 4-6)
3. 2-stroke engine oil tank cap (page 4-5)
4. Engine stop switch (page 4-1)
5. Front brake lever (page 4-2)
6. Throttle grip (page 7-12)
7. Fuel tank cap (page 4-3)

Handlebar switch

EAU40660

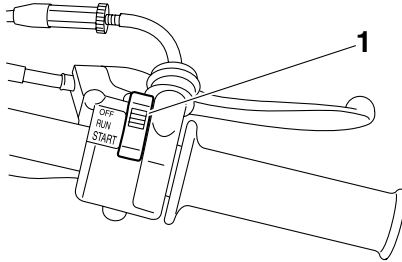

1. Engine stop switch “OFF/RUN/START”

Engine stop switch “OFF/RUN/START”

EAU40674

Set this switch to “START” before starting the engine. Set this switch to “RUN” after warming up the engine or before starting off. Set this switch to “OFF” to stop the engine.

TIP

- The engine cannot be started with this switch set to the “RUN” position.

- The engine speed is limited while this switch is set to the “START” position, therefore the motorcycle cannot be ridden in that switch position.

Speed limiter and power reduction plate

EAU41043

Your motorcycle is equipped with an adjustable speed limiter and a power reduction plate. The speed limiter keeps the throttle from fully opening, even when the throttle grip is turned to the maximum. The power reduction plate is installed in the exhaust manifold to limit the amount of power available while learning.

Speed limiter

1. Loosen the locknut.
2. To increase the maximum engine power available and the maximum speed of the motorcycle, turn the adjusting screw in direction (a). To decrease the maximum engine power available and the maximum speed of the motorcycle, turn the adjusting screw in direction (b).

INSTRUMENT AND CONTROL FUNCTIONS

EAU12900

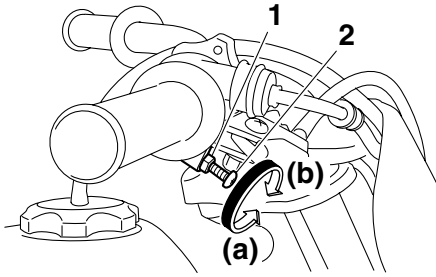

1. Locknut
2. Adjusting screw
3. Tighten the locknut.

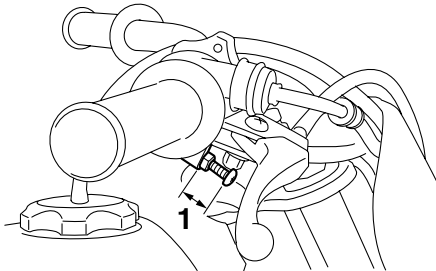

1. No more than 7 mm (0.28 in)

TIP

The adjusting range of the speed limiter screw is from the fully turned-in position to 7 mm (0.28 in) turned out. When the screw is turned out to 7 mm (0.28 in),

the throttle grip can only be opened approximately halfway. If more power is required, please consult a Yamaha dealer.

WARNING

EWA14630

Improper adjustment of the speed limiter could cause improper throttle operation. You could lose control, have an accident or be injured. Do not turn the adjusting screw out more than 7 mm (0.28 in) before consulting a Yamaha dealer. Always make sure the throttle cable free play is adjusted to 1.5–3.5 mm (0.06–0.14 in). (See page 7-12.)

Power reduction plate

Once the rider can operate with skill at the top speed permitted by adjusting the speed limiter alone, the power reduction plate can be removed. (See page 7-7.)

Front brake lever

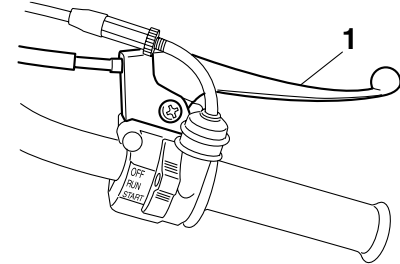

1. Front brake lever

The front brake lever is located on the right handlebar grip. To apply the front brake, pull this lever toward the handlebar grip.

Rear brake lever

EAU12950

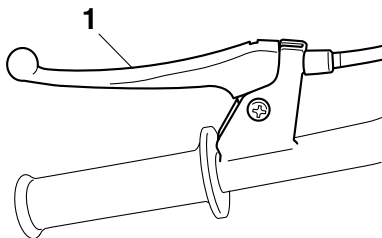

1. Rear brake lever

The rear brake lever is located on the left handlebar grip. To apply the rear brake, pull this lever toward the handlebar grip.

Fuel tank cap

EAU13182

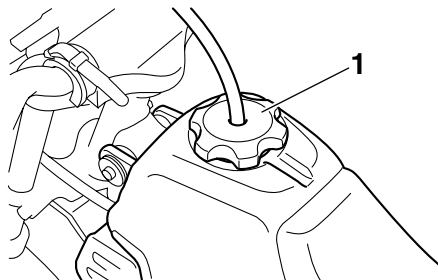

1. Fuel tank cap

To remove the fuel tank cap, turn it counterclockwise, and then pull it off. To install the fuel tank cap, insert it into the tank opening, and then turn it clockwise.

! WARNING

Make sure that the fuel tank cap is properly closed after filling fuel. Leaking fuel is a fire hazard.

EWA11091

Fuel

EAU13212

Make sure there is sufficient gasoline in the tank.

EWA10881

! WARNING

Gasoline and gasoline vapors are extremely flammable. To avoid fires and explosions and to reduce the risk of injury when refueling, follow these instructions.

1. Before refueling, turn off the engine and be sure that no one is sitting on the vehicle. Never refuel while smoking, or while in the vicinity of sparks, open flames, or other sources of ignition such as the pilot lights of water heaters and clothes dryers.
2. Do not overfill the fuel tank. Stop filling when the fuel reaches the bottom of the filler tube. Because fuel expands when it heats up, heat from the engine or the sun can cause fuel to spill out of the fuel tank.

INSTRUMENT AND CONTROL FUNCTIONS

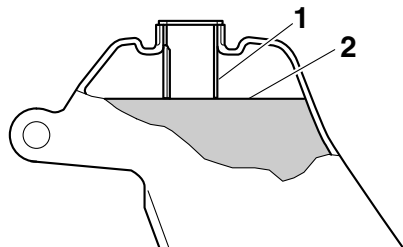

4

1. Fuel tank filler tube
2. Maximum fuel level
3. Wipe up any spilled fuel immediately. **NOTICE: Immediately wipe off spilled fuel with a clean, dry, soft cloth, since fuel may deteriorate painted surfaces or plastic parts.** [ECA10071]
4. Be sure to securely close the fuel tank cap.

EWA15151

WARNING

Gasoline is poisonous and can cause injury or death. Handle gasoline with care. Never siphon gasoline by mouth. If you should swallow some gasoline or inhale a lot of gasoline vapor, or get some gasoline in your eyes, see your doctor immedi-

ately. If gasoline spills on your skin, wash with soap and water. If gasoline spills on your clothing, change your clothes.

EAU41982

For Canada

Recommended fuel:
REGULAR UNLEADED GASOLINE ONLY
Fuel tank capacity:
2.0 L (0.53 US gal, 0.44 Imp.gal)

ECA15590

NOTICE

Use only unleaded gasoline. The use of leaded gasoline will cause severe damage to internal engine parts, such as the piston rings as well as to the exhaust system.

Your Yamaha engine has been designed to use regular unleaded gasoline with a pump octane number $[(R+M)/2]$ of 86 or higher, or a research octane number of 91 or higher. If knocking (or pinging) occurs, use a gasoline of a different brand or premi-

um unleaded fuel. Use of unleaded fuel will extend spark plug life and reduce maintenance cost.

Gasohol

There are two types of gasohol: gasohol containing ethanol and that containing methanol. Gasohol containing ethanol can be used if ethanol content does not exceed 10% (E10). Gasohol containing methanol is not recommended by Yamaha because it can cause damage to the fuel system or vehicle performance problems.

For Europe, Oceania and South Africa

Recommended fuel:

For Europe and South Africa: REGULAR UNLEADED GASOLINE ONLY

For Oceania: UNLEADED GASOLINE ONLY

Fuel tank capacity:

2.0 L (0.53 US gal, 0.44 Imp.gal)

ECA15590

NOTICE

Use only unleaded gasoline. The use of leaded gasoline will cause severe damage to internal engine parts, such as the piston rings as well as to the exhaust system.

Your Yamaha engine has been designed to use regular unleaded gasoline with a research octane number of 91 or higher. If knocking (or pinging) occurs, use a gasoline of a different brand or premium unleaded fuel. Use of unleaded fuel will extend spark plug life and reduce maintenance costs.

Fuel tank breather hose

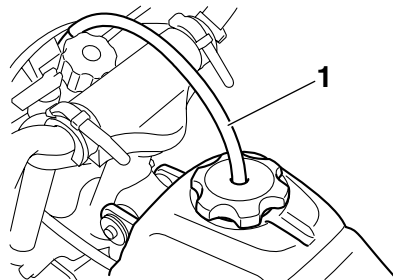

1. Fuel tank breather hose

Before operating the motorcycle:

- Check the fuel tank breather hose connection.
- Check the fuel tank breather hose for cracks or damage, and replace it if damaged.
- Make sure that the fuel tank breather hose is not blocked, and clean it if necessary.

EAU13412

2-stroke engine oil

Make sure that there is sufficient 2-stroke engine oil in the oil tank. Add the recommended 2-stroke engine oil as necessary.

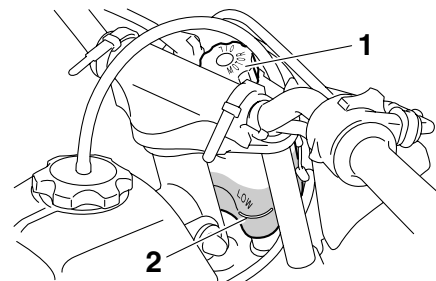

1. 2-stroke engine oil tank cap
2. Minimum level mark

Recommended oil:

See page 9-1.

Oil quantity:

0.30 L (0.32 US qt, 0.26 Imp.qt)

ECA16670

NOTICE

Make sure that the 2-stroke engine oil tank cap is properly installed.

INSTRUMENT AND CONTROL FUNCTIONS

EAU40701

Fuel cock

The fuel cock supplies fuel from the tank to the carburetor while filtering it also.

The fuel cock has two positions:

S (stop)

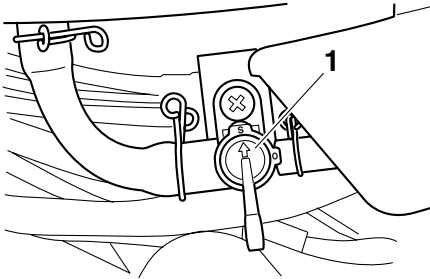

1. Arrow mark pointing to “S” (stop)

With the lever in this position, fuel will not flow. Always return the lever to this position when the engine is not running.

O (on)

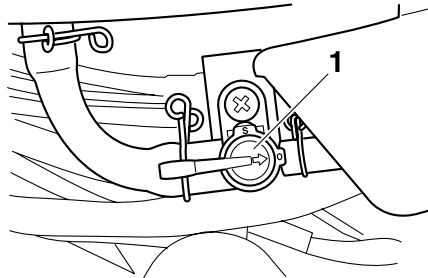

1. Arrow mark pointing to “O” (on)

With the lever in this position, fuel flows to the carburetor. Normal riding is done with the lever in this position.

EAU13590

Starter (choke) lever “|v|”

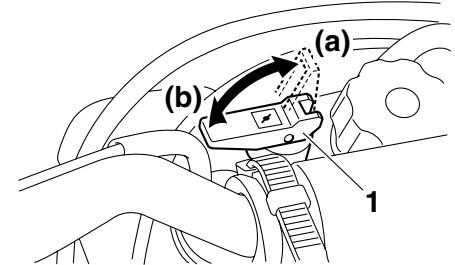

1. Starter (choke) lever “|v|”

Starting a cold engine requires a richer air-fuel mixture, which is supplied by the starter (choke).

Move the lever in direction (a) to turn on the starter (choke).

Move the lever in direction (b) to turn off the starter (choke).

INSTRUMENT AND CONTROL FUNCTIONS

Kickstarter

EAU13680

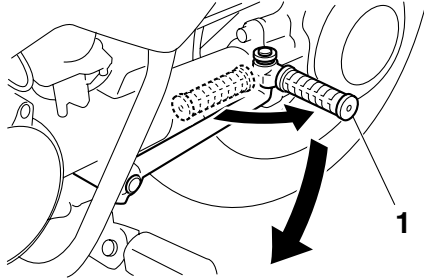

1. Kickstarter

To start the engine, fold out the kickstarter lever, move it down lightly with your foot until the gears engage, and then push it down smoothly but forcefully.

Seat

EAU40920

To remove the seat

1. Remove the mudguard by removing the bolts and washers.

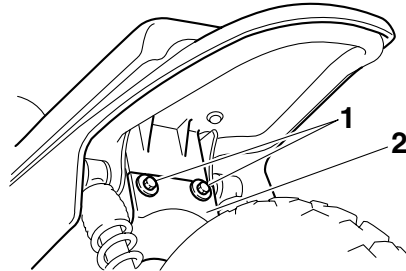

1. Bolt and washer
2. Mudguard

2. Pull the seat off.

To install the seat

1. Insert the projection on the front of the seat into the seat holder as shown.

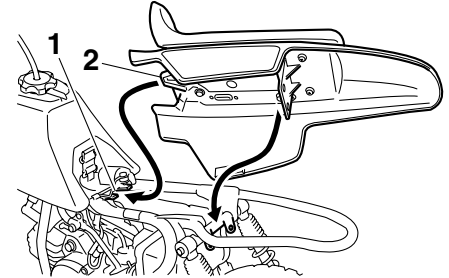

1. Seat holder
2. Projection

2. Place the seat in the original position.
3. Install the mudguard by installing the washers and bolts.

TIP

Make sure that the seat is properly secured before riding.

FOR YOUR SAFETY – PRE-OPERATION CHECKS

EAU15596

Inspect your vehicle each time you use it to make sure the vehicle is in safe operating condition. Always follow the inspection and maintenance procedures and schedules described in the Owner's Manual.

EWA11151

WARNING

Failure to inspect or maintain the vehicle properly increases the possibility of an accident or equipment damage. Do not operate the vehicle if you find any problem. If a problem cannot be corrected by the procedures provided in this manual, have the vehicle inspected by a Yamaha dealer.

Before using this vehicle, check the following points:

ITEM	CHECKS	PAGE
Fuel	<ul style="list-style-type: none">• Check fuel level in fuel tank.• Refuel if necessary.• Check fuel line for leakage.• Check the fuel tank breather/overflow hose for obstructions, cracks or damage, and check the hose connection.	4-3, 4-5
2-stroke engine oil	<ul style="list-style-type: none">• Check oil level in oil tank.• If necessary, add recommended oil to specified level.• Check vehicle for oil leakage.	4-5
Middle and final gear cases	<ul style="list-style-type: none">• Check vehicle for grease leakage.	7-9
Front brake	<ul style="list-style-type: none">• Check operation.• Lubricate cable if necessary.• Check lever free play.• Adjust if necessary.	7-14, 7-15
Rear brake	<ul style="list-style-type: none">• Check operation.• Lubricate cable if necessary.• Check lever free play.• Adjust if necessary.	7-14, 7-15

FOR YOUR SAFETY – PRE-OPERATION CHECKS

ITEM	CHECKS	PAGE
Throttle grip	<ul style="list-style-type: none"> • Make sure that operation is smooth. • Check cable free play. • If necessary, have Yamaha dealer adjust cable free play and lubricate cable and grip housing. 	7-12, 7-16
Control cables	<ul style="list-style-type: none"> • Make sure that operation is smooth. • Lubricate if necessary. 	7-15
Wheels and tires	<ul style="list-style-type: none"> • Check for damage. • Check tire condition and tread depth. • Check air pressure. • Correct if necessary. 	7-12, 7-13
Brake levers	<ul style="list-style-type: none"> • Make sure that operation is smooth. • Lubricate lever pivoting points if necessary. 	7-16
Centerstand	<ul style="list-style-type: none"> • Make sure that operation is smooth. • Lubricate pivot if necessary. 	7-17
Chassis fasteners	<ul style="list-style-type: none"> • Make sure that all nuts, bolts and screws are properly tightened. • Tighten if necessary. 	—
Engine stop switch	<ul style="list-style-type: none"> • Check operation. 	4-1

OPERATION AND IMPORTANT RIDING POINTS

EAU15951

Read the Owner's Manual carefully to become familiar with all controls. If there is a control or function you do not understand, ask your Yamaha dealer.

EWA10271

WARNING

Failure to familiarize yourself with the controls can lead to loss of control, which could cause an accident or injury.

EAU40888

Starting and warming up a cold engine

1. Turn the fuel cock lever to "O" (on).
2. Set the engine stop switch to "START".
3. Turn the starter (choke) on and completely close the throttle. (See page 4-6.)
4. While applying the front or rear brake, start the engine by pushing the kickstarter lever down.
5. After starting the engine, move the starter (choke) back halfway.
NOTICE: For maximum engine life, never accelerate hard when the engine is cold!^[ECA11041]
6. When the engine is warm, turn the starter (choke) off and set the engine stop switch to "RUN".

TIP

The engine is warm when it responds quickly to the throttle with the starter (choke) turned off.

EAU16660

Starting a warm engine

Follow the same procedure as for starting a cold engine with the exception that the starter (choke) is not required when the engine is warm. Instead, start the engine with the throttle slightly open.

TIP

If the engine does not start after several kicks, try again with the throttle 1/4 to 1/2 open.

OPERATION AND IMPORTANT RIDING POINTS

Starting off

EAU41002

1. While applying the rear brake lever, push the motorcycle off the centerstand.
2. Completely close the throttle.
3. Set the engine stop switch to "RUN".
4. Check for oncoming off-road vehicles, and then slowly turn the throttle grip in order to take off.

Acceleration and deceleration

EAU16780

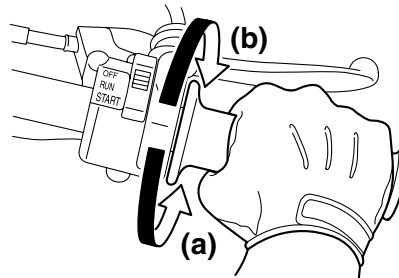

The speed can be adjusted by opening and closing the throttle. To increase the speed, turn the throttle grip in direction (a). To reduce the speed, turn the throttle grip in direction (b).

Braking

EAU41012

EWA14571

⚠ WARNING

- Avoid braking hard or suddenly (especially when leaning over to one side), otherwise the motorcycle may skid or overturn.
- Keep in mind that braking on wet surfaces is much more difficult.
- Ride slowly down a hill, as braking downhill can be very difficult.

1. Close the throttle completely.
2. Apply both front and rear brakes simultaneously while gradually increasing the pressure.

6

Front

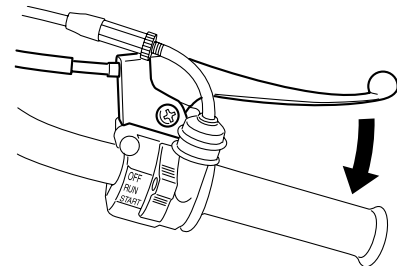

OPERATION AND IMPORTANT RIDING POINTS

Rear

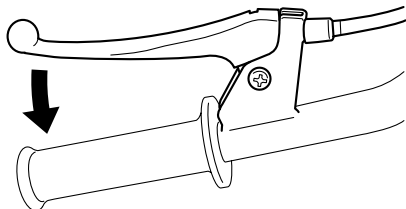

Engine break-in

EAU42030

There is never a more important period in the life of your engine than the first 5 hours of riding. It is also important to acustom the rider to the motorcycle during this time. Please read the following information carefully.

Since the engine is brand new, do not put an excessive load on it for the first 5 hours of operation. The various parts in the engine wear and polish themselves to the correct operating clearances. During this period, prolonged full-throttle operation or any condition that might result in engine overheating must be avoided. However, momentary full-throttle operation under load (i.e., two to three seconds maximum) does not harm the engine. Each full-throttle acceleration should be followed with a substantial rest period for the engine. To allow the engine to cool down from the temporary buildup of heat, cruise at a lower engine speed.

After the first 5 hours of operation, thoroughly check the motorcycle for loose parts, oil leakage and any other problems. Be sure to inspect and make ad-

justments thoroughly, especially cables. In addition, check all fittings and fasteners for looseness, and tighten if necessary.

ECA10270

NOTICE

If any engine trouble should occur during the engine break-in period, immediately have a Yamaha dealer check the vehicle.

EAU40722

Parking

When parking, stop the engine, and then turn the fuel cock lever to “S” (stop).

EWA10311

WARNING

- Since the engine and exhaust system can become very hot, park in a place where pedestrians or children are not likely to touch them and be burned.
 - Do not park on a slope or on soft ground, otherwise the vehicle may overturn, increasing the risk of a fuel leak and fire.
 - Do not park near grass or other flammable materials which might catch fire.
-

PERIODIC MAINTENANCE AND ADJUSTMENT

EAU41952

Periodic inspection, adjustment, and lubrication will keep your vehicle in the safest and most efficient condition possible. Safety is an obligation of the vehicle owner/operator. The most important points of vehicle inspection, adjustment, and lubrication are explained on the following pages.

WARNING

EWA10321

Failure to properly maintain the vehicle or performing maintenance activities incorrectly may increase your risk of injury or death during service or while using the vehicle. If you are not familiar with vehicle service, have a Yamaha dealer perform service.

WARNING

EWA15121

Turn off the engine when performing maintenance unless otherwise specified.

- **A running engine has moving parts that can catch on body parts or clothing and electrical parts that can cause shocks or fires.**
- **Running the engine while servicing can lead to eye injury, burns, fire, or carbon monoxide poisoning – possibly leading to death. See page 2-1 for more information about carbon monoxide.**

WARNING

EWA15460

Brake discs, calipers, drums, and linings can become very hot during use. To avoid possible burns, let brake components cool before touching them.

EAU17302

Emission controls not only function to ensure cleaner air, but are also vital to proper engine operation and maximum performance. In the following periodic maintenance charts, the services related to emissions control are grouped separately. These services require specialized data, knowledge, and equipment. Maintenance, replacement, or repair of the emission control devices and systems may be performed by any repair establishment or individual that is certified (if applicable). Yamaha dealers are trained and equipped to perform these particular services.

EAU17311

Owner's tool kit

The service information included in this manual and the tools provided in the owner's tool kit are intended to assist you in the performance of preventive maintenance and minor repairs. However, additional tools such as a torque wrench may be necessary to perform certain maintenance work correctly.

TIP _____

If you do not have the tools or experience required for a particular job, have a Yamaha dealer perform it for you.

PERIODIC MAINTENANCE AND ADJUSTMENT

EAU41741

Periodic maintenance chart for the emission control system

TIP

- From 18 months, repeat the maintenance intervals starting from 6 months.
- Items marked with an asterisk should be performed by a Yamaha dealer as they require special tools, data and technical skills.

NO.	ITEM	CHECK OR MAINTENANCE JOB	INITIAL			THEREAFTER EVERY	
			1 month	3 months	6 months	6 months	12 months
1	* Fuel line	<ul style="list-style-type: none"> ● Check fuel hoses for cracks or damage. ● Replace if necessary. 	√	√	√	√	
2	Spark plug	<ul style="list-style-type: none"> ● Check condition. ● Adjust gap and clean. ● Replace if necessary. 	√	√	√	√	
3	Air filter element	<ul style="list-style-type: none"> ● Clean with solvent. ● Replace if necessary. 		√	√	√	
4	* Carburetor	<ul style="list-style-type: none"> ● Check engine idling speed and starter operation. ● Adjust if necessary. ● Clean. 		√	√	√	√
5	* Cylinder head and exhaust system	<ul style="list-style-type: none"> ● Check for leakage. ● Tighten if necessary. ● Decarbonize if necessary. 		√	√	√	
6	* Spark arrester	<ul style="list-style-type: none"> ● Clean. 			√	√	

PERIODIC MAINTENANCE AND ADJUSTMENT

EAU41755

General maintenance and lubrication chart

TIP

- From 18 months, repeat the maintenance intervals starting from 6 months.
- Items marked with an asterisk should be performed by a Yamaha dealer as they require special tools, data and technical skills.

NO.	ITEM	CHECK OR MAINTENANCE JOB	INITIAL			THEREAFTER EVERY		
			1 month	3 months	6 months	6 months	12 months	
1	*	Front brake	<ul style="list-style-type: none"> ● Check operation. ● Adjust brake lever free play. 	√	√	√	√	
			<ul style="list-style-type: none"> ● Replace brake shoes. 	Whenever worn to the limit				
2	*	Rear brake	<ul style="list-style-type: none"> ● Check operation. ● Adjust brake lever free play. 	√	√	√	√	
			<ul style="list-style-type: none"> ● Replace brake shoes. 	Whenever worn to the limit				
3	*	Wheels	<ul style="list-style-type: none"> ● Check runout and for damage. ● Replace if necessary. 	√	√	√	√	
4	*	Tires	<ul style="list-style-type: none"> ● Check tread depth and for damage. ● Replace if necessary. ● Check air pressure. ● Correct if necessary. 	√	√	√	√	
5	*	Wheel bearings	<ul style="list-style-type: none"> ● Check bearings for smooth operation. ● Replace if necessary. 					√
6	*	Steering bearings	<ul style="list-style-type: none"> ● Check bearing assemblies for looseness. ● Moderately repack with lithium-soap-based grease every 2 years. 			√		√

PERIODIC MAINTENANCE AND ADJUSTMENT

NO.	ITEM	CHECK OR MAINTENANCE JOB	INITIAL			THEREAFTER EVERY	
			1 month	3 months	6 months	6 months	12 months
7	* Middle and final gear cases	<ul style="list-style-type: none"> • Check for grease leakage. • Check gears for damage and wear. • Lubricate gears with lithium-soap-based grease. 	√	√	√	√	√
8	* Chassis fasteners	<ul style="list-style-type: none"> • Check all chassis fitting and fasteners. • Correct if necessary. 	√	√	√	√	
9	* Autolube pump	<ul style="list-style-type: none"> • Check operation. • Correct if necessary. 	√	√	√	√	
10	* Transmission oil	<ul style="list-style-type: none"> • Check for oil leakage. • Correct if necessary. • Change. 	√	√	√	√	
11	* Front and rear brake lever pivot	<ul style="list-style-type: none"> • Apply lithium-soap-based grease lightly. 		√	√	√	
12	* Centerstand pivot	<ul style="list-style-type: none"> • Check operation. • Apply lithium-soap-based grease lightly. 		√	√	√	
13	* Shock absorber assemblies	<ul style="list-style-type: none"> • Check operation and for oil leakage. • Replace if necessary. 	√	√	√	√	
14	* Control cables	<ul style="list-style-type: none"> • Apply Yamaha chain and cable lube or engine oil 10W-30 lightly. 		√	√		√
15	* Throttle grip housing and cable	<ul style="list-style-type: none"> • Check operation and free play. • Apply Yamaha chain and cable lube or engine oil 10W-30 lightly. 	√	√	√	√	

TIP

The air filter needs more frequent service if you are riding in unusually wet or dusty areas.

PERIODIC MAINTENANCE AND ADJUSTMENT

EAU19604

Checking the spark plug

The spark plug is an important engine component, which is easy to check. Since heat and deposits will cause any spark plug to slowly erode, the spark plug should be removed and checked in accordance with the periodic maintenance and lubrication chart. In addition, the condition of the spark plug can reveal the condition of the engine.

To remove the spark plug

1. Remove the spark plug cap.

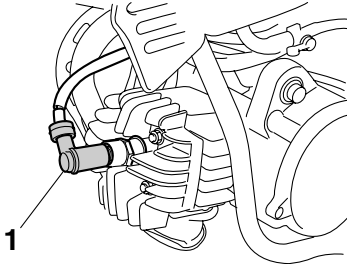

1. Spark plug cap

2. Remove the spark plug as shown, with the spark plug wrench included in the owner's tool kit.

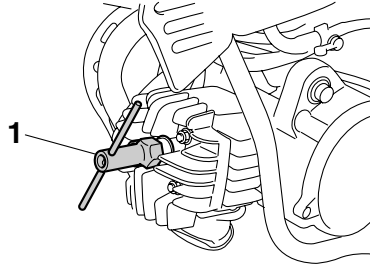

1. Spark plug wrench

To check the spark plug

1. Check that the porcelain insulator around the center electrode of the spark plug is a medium-to-light tan (the ideal color when the vehicle is ridden normally).

TIP

If the spark plug shows a distinctly different color, the engine could be operating improperly. Do not attempt to diagnose such problems yourself. Instead, have a Yamaha dealer check the vehicle.

2. Check the spark plug for electrode erosion and excessive carbon or other deposits, and replace it if necessary.

Specified spark plug:
NGK/BPR4HS

3. Measure the spark plug gap with a wire thickness gauge and, if necessary, adjust the gap to specification.

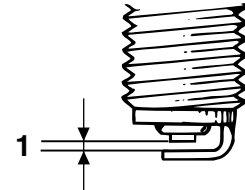

1. Spark plug gap

Spark plug gap:
0.6–0.7 mm (0.024–0.028 in)

PERIODIC MAINTENANCE AND ADJUSTMENT

To install the spark plug

1. Clean the surface of the spark plug gasket and its mating surface, and then wipe off any grime from the spark plug threads.
2. Install the spark plug with the spark plug wrench, and then tighten it to the specified torque.

Tightening torque:

Spark plug:
20 Nm (2.0 m·kgf, 14 ft·lbf)

TIP

If a torque wrench is not available when installing a spark plug, a good estimate of the correct torque is 1/4–1/2 turn past finger tight. However, the spark plug should be tightened to the specified torque as soon as possible.

3. Install the spark plug cap.

Removing the power reduction plate

EAU41103

To obtain full engine performance capability, removing the power reduction plate is required.

1. Remove the exhaust manifold by removing the bolts. **WARNING! Always let the exhaust system cool prior to touching exhaust components.** [EWA145B1]

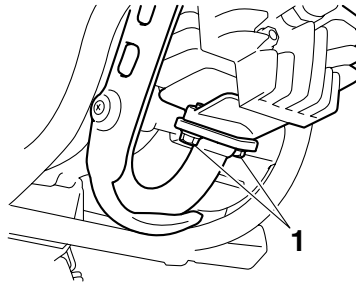

1. Exhaust manifold bolt
2. Remove the gasket.
3. Remove the power reduction plate.

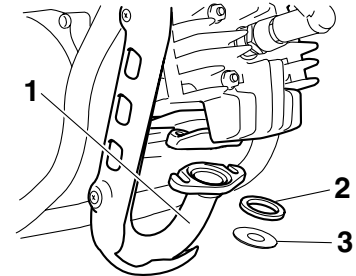

1. Exhaust manifold
2. Gasket
3. Power reduction plate

TIP

Store the power reduction plate with the Owner's Manual so that it is readily available whenever you want to reduce the engine power.

4. Install the exhaust manifold and its new gasket by installing the bolts, and then tighten the bolts to the specified torque.

Tightening torque:

Exhaust manifold bolt:
9 Nm (0.9 m·kgf, 6.5 ft·lbf)

PERIODIC MAINTENANCE AND ADJUSTMENT

EAU40893

ECA10452

Transmission oil

The transmission oil must be checked for oil leakage before each ride. If any leakage is found, have a Yamaha dealer check and repair the motorcycle. In addition, the transmission oil must be changed at the intervals specified in the periodic maintenance and lubrication chart.

1. Place the motorcycle on the centerstand.
2. Place an oil pan under the transmission to collect the used oil.
3. Remove the transmission oil filler cap, the transmission oil drain bolt and its gasket to drain the oil from the transmission.

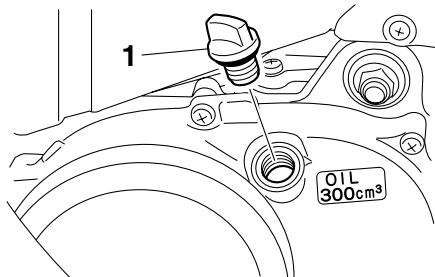

1. Transmission oil filler cap

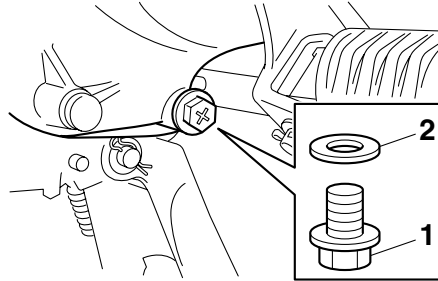

1. Transmission oil drain bolt
2. Gasket

4. Install the transmission oil drain bolt and its new gasket, and then tighten the bolt to the specified torque.

Tightening torque:

Transmission oil drain bolt:
14 Nm (1.4 m·kgf, 10 ft·lbf)

5. Refill with the specified amount of the recommended transmission oil, and then install and tighten the oil filler cap.

Recommended transmission oil:

See page 9-1.

Oil change quantity:

0.30 L (0.32 US qt, 0.26 Imp.qt)

NOTICE

- In order to prevent clutch slip-page (since the transmission oil also lubricates the clutch), do not mix any chemical additives. Do not use oils with a diesel specification of “CD” or oils of a higher quality than specified. In addition, do not use oils labeled “ENERGY CONSERVING II” or higher.
 - Make sure that no foreign material enters the transmission.
6. Start the engine, and then let it idle for several minutes while checking the transmission for oil leakage. If oil is leaking, immediately turn the engine off and check for the cause.

PERIODIC MAINTENANCE AND ADJUSTMENT

EAU41711

Middle and final gear cases

The middle and final gear cases must be checked for grease leakage before each ride. If any leakage is found, have a Yamaha dealer check and repair the motorcycle. In addition, have a Yamaha dealer check and lubricate the middle and final gears at the intervals specified in the periodic maintenance and lubrication chart.

EAU40903

Cleaning the air filter element

The air filter element should be cleaned at the intervals specified in the periodic maintenance and lubrication chart. Clean or, if necessary, replace the air filter element more frequently if you are riding in unusually wet or dusty areas.

1. Remove the seat. (See page 4-7.)
2. Remove the air filter case cover by removing the screw.

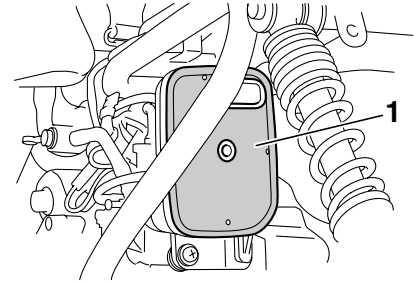

1. Sponge material

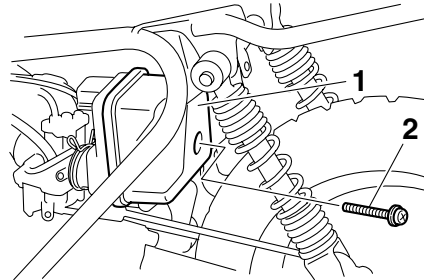

1. Air filter case cover
2. Screw

3. Pull the sponge material out, clean it with solvent, and then squeeze the remaining solvent out.

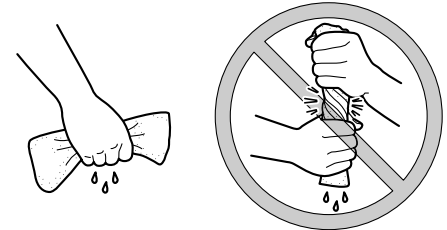

4. Apply oil of the recommended type to the entire surface of the sponge material, and then squeeze the excess oil out.

TIP

The sponge material should be wet but not dripping.

PERIODIC MAINTENANCE AND ADJUSTMENT

Recommended oil:

Yamaha foam air filter oil or other quality foam air filter oil

5. Insert the sponge material into the air filter case. **NOTICE: Make sure that the sponge material is properly seated in the air filter case. The engine should never be operated without the sponge material installed, otherwise the piston(s) and/or cylinder(s) may become excessively worn.**

[ECA15621]

6. Install the air filter case cover by installing the screw.
7. Install the seat.

Cleaning the spark arrester

EAU41221

The spark arrester should be cleaned at the intervals specified in the periodic maintenance and lubrication chart.

EWA10980

⚠ WARNING

- Always let the exhaust system cool prior to touching exhaust components.
- Do not start the engine when cleaning the exhaust system.

1. Remove the tailpipe by removing the screw, and then pulling it out of the muffler.

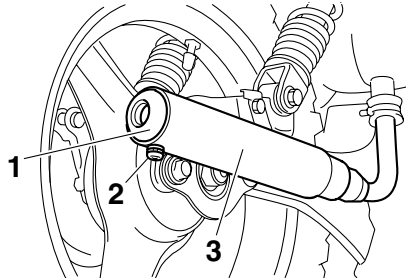

1. Tailpipe
2. Screw
3. Muffler

2. Tap the tailpipe lightly, and then use a wire brush to remove any carbon deposits from the spark arrester portion of the tailpipe and inside of the tailpipe housing.

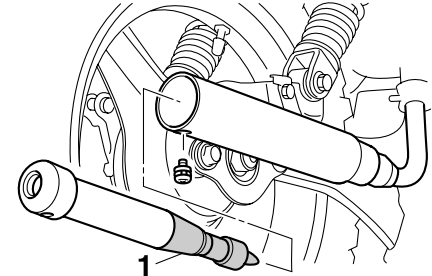

1. Spark arrester

3. Insert the tailpipe into the muffler, and then install and tighten the screw.

TIP

Make sure to align the screw hole when inserting the tailpipe.

PERIODIC MAINTENANCE AND ADJUSTMENT

Adjusting the carburetor

EAU39930

The carburetor is an important part of the engine and requires very sophisticated adjustment. Therefore, most carburetor adjustments should be left to a Yamaha dealer, who has the necessary professional knowledge and experience. The adjustment described in the following section, however, may be serviced by the owner as part of routine maintenance.

ECA10550

NOTICE

The carburetor has been set and extensively tested at the Yamaha factory. Changing these settings without sufficient technical knowledge may result in poor performance of or damage to the engine.

7

Adjusting the engine idling speed

EAU21362

The engine idling speed must be checked and, if necessary, adjusted as follows at the intervals specified in the periodic maintenance and lubrication chart.

TIP

A diagnostic tachometer is needed to make this adjustment.

1. Attach the tachometer to the spark plug lead.
2. Start the engine and warm it up for several minutes at 1000–2000 r/min while occasionally revving it to 4000–5000 r/min.

TIP

The engine is warm when it quickly responds to the throttle.

3. Check the engine idling speed and, if necessary, adjust it to specification by turning the throttle stop screw. To increase the engine idling speed, turn the screw in di-

rection (a). To decrease the engine idling speed, turn the screw in direction (b).

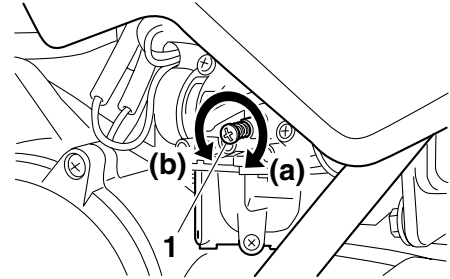

1. Throttle stop screw

Engine idling speed:
1650–1750 r/min

TIP

If the specified idling speed cannot be obtained as described above, have a Yamaha dealer make the adjustment.

PERIODIC MAINTENANCE AND ADJUSTMENT

Checking the throttle cable free play

EAU21383

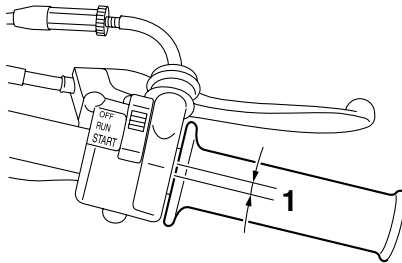

1. Throttle cable free play

The throttle cable free play should measure 1.5–3.5 mm (0.06–0.14 in) at the inner edge of the throttle grip. Periodically check the throttle cable free play and, if necessary, have a Yamaha dealer adjust it.

Tires

EAU40913

To maximize the performance, durability, and safe operation of your motorcycle, note the following points regarding the specified tires.

Tire air pressure

The tire air pressure should be checked and, if necessary, adjusted before each ride.

⚠ WARNING

EWA15370

Operation of this vehicle with improper tire pressure may cause severe injury or death from loss of control.

The tire air pressure must be checked and adjusted on cold tires (i.e., when the temperature of the tires equals the ambient temperature).

Standard tire air pressure:

Front:
100 kPa (1.00 kgf/cm², 15 psi)
Rear:
100 kPa (1.00 kgf/cm², 15 psi)

Tire inspection

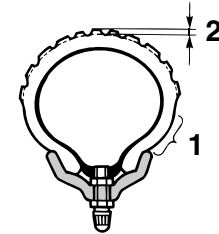

1. Tire sidewall
2. Tire tread depth

The tires must be checked before each ride. If the center tread depth reaches the specified limit, if the tire has a nail or glass fragments in it, or if the sidewall is cracked, have a Yamaha dealer replace the tire immediately.

Minimum tire tread depth (front and rear):
4.0 mm (0.16 in)

Tire information

This motorcycle is equipped with panel wheels and tube tires.

PERIODIC MAINTENANCE AND ADJUSTMENT

EWA10461

WARNING

The front and rear tires should be of the same make and design, otherwise the handling characteristics of the vehicle may be different, which could lead to an accident.

After extensive tests, only the tires listed below have been approved for this model by Yamaha Motor Co., Ltd.

Front tire:

Size:

2.50-10 4PR

Manufacturer/model:

BRIDGESTONE/KNOBBY
IRC/KNOBBY

Rear tire:

Size:

2.50-10 4PR

Manufacturer/model:

BRIDGESTONE/KNOBBY
IRC/KNOBBY

EWA15541

WARNING

- Have a Yamaha dealer replace excessively worn tires. Operating the motorcycle with exces-

sively worn tires decreases riding stability and can lead to loss of control.

- The replacement of all wheel- and brake-related parts, including the tires, should be left to a Yamaha dealer, who has the necessary professional knowledge and experience.
- It is not recommended to patch a punctured tube. If unavoidable, however, patch the tube very carefully and replace it as soon as possible with a high-quality product.
- Ride conservatively after changing a tire since the tire must seat itself on the rim properly. Failure to allow proper seating may cause tire failure, which may result in damage to the motorcycle and injury to the rider.

EAU40781

Panel wheels

EWA10610

WARNING

The wheels on this model are not designed for use with tubeless tires. Do not attempt to use tubeless tires on this model.

To maximize the performance, durability, and safe operation of your motorcycle, note the following points regarding the specified wheels.

- The wheel rims should be checked for cracks, bends, warpage or damage before each ride. If any damage is found, have a Yamaha dealer replace the wheel. Do not attempt even the smallest repair to the wheel. A deformed or cracked wheel must be replaced.
- The wheel should be balanced whenever either the tire or wheel has been changed or replaced. An unbalanced wheel can result in poor performance, adverse handling characteristics, and a shortened tire life.

PERIODIC MAINTENANCE AND ADJUSTMENT

Adjusting the front and rear brake lever free play

EAU22151

Front

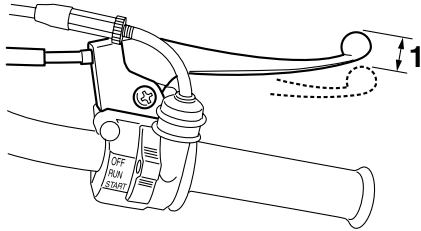

1. Front brake lever free play

Rear

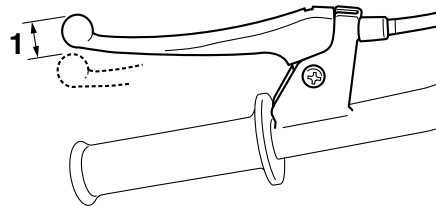

1. Rear brake lever free play

The front and rear brake lever free play should be measured at the positions as shown.

Front brake lever free play:
10.0–20.0 mm (0.39–0.79 in)
Rear brake lever free play:
10.0–20.0 mm (0.39–0.79 in)

Periodically check the front and rear brake lever free play and, if necessary, adjust them as follows.

To increase the brake lever free play, turn the adjusting nut at the brake shoe plate in direction (a). To decrease the brake lever free play, turn the adjusting nut in direction (b).

Front

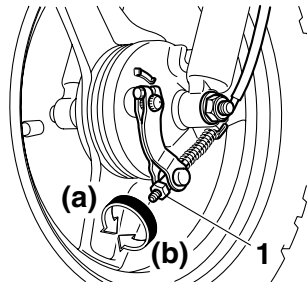

1. Brake lever free play adjusting nut

Rear

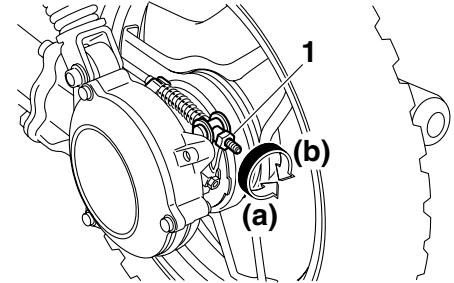

1. Brake lever free play adjusting nut

EWA10650

! WARNING

If proper adjustment cannot be obtained as described, have a Yamaha dealer make this adjustment.

PERIODIC MAINTENANCE AND ADJUSTMENT

Checking the front and rear brake shoes

EAU41052

The front and rear brake shoes must be checked for wear at the intervals specified in the periodic maintenance and lubrication chart.

TIP

The wheels must be removed to check brake shoe lining thickness.

- To remove the front wheel: See page 7-18.
- To remove the rear wheel: See page 7-20.

Front

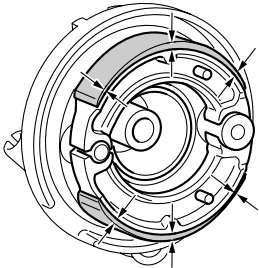

Rear

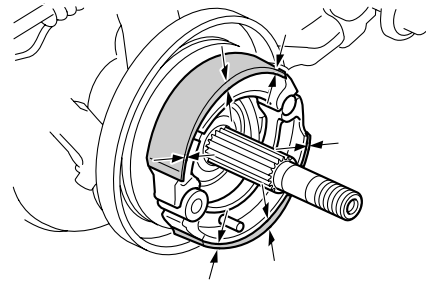

If the lining thickness of a brake shoe is less than 1.5 mm (0.06 in), have a Yamaha dealer replace the brake shoes as a set.

TIP

Be sure to measure the brake lining at the thinnest portion.

Checking and lubricating the cables

EAU41842

The operation of all control cables and the condition of the cables should be checked before each ride, and the cables and cable ends should be lubricated if necessary. If a cable is damaged or does not move smoothly, have a Yamaha dealer check or replace it. **WARNING! Damage to the outer housing of cables may result in internal rusting and cause interference with cable movement. Replace damaged cables as soon as possible to prevent unsafe conditions.**

[EWA10711]

Recommended lubricant:

Yamaha Chain and Cable Lube or 4-stroke engine oil

PERIODIC MAINTENANCE AND ADJUSTMENT

Checking and lubricating the throttle grip and cable

EAU23113

The operation of the throttle grip should be checked before each ride. In addition, the cable should be lubricated by a Yamaha dealer at the intervals specified in the periodic maintenance chart. The throttle cable is equipped with a rubber boot. Make sure that the boot is securely installed. Even though the boot is installed correctly, it does not completely protect the cable from water entry. Therefore, use care not to pour water directly onto the boot or cable when washing the vehicle. If the cable or boot becomes dirty, wipe clean with a moist cloth.

Adjusting the Autolube pump

EAU23120

The Autolube pump is a vital and sophisticated component of the engine, which must be adjusted by a Yamaha dealer at the intervals specified in the periodic maintenance and lubrication chart.

Lubricating the front and rear brake levers

EAU43631

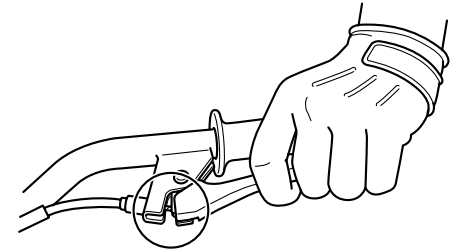

The pivoting points of the front and rear brake levers must be lubricated at the intervals specified in the periodic maintenance and lubrication chart.

Recommended lubricant:
Lithium-soap-based grease

PERIODIC MAINTENANCE AND ADJUSTMENT

Checking and lubricating the centerstand

EAU23192

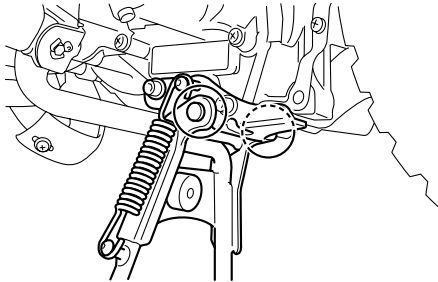

The operation of the centerstand should be checked before each ride, and the pivots and metal-to-metal contact surfaces should be lubricated if necessary.

EWA11301

⚠ WARNING

If the centerstand does not move up and down smoothly, have a Yamaha dealer check or repair it. Otherwise, the centerstand could contact the ground and distract the operator, resulting in a possible loss of control.

Recommended lubricant:
Lithium-soap-based grease

Checking the front fork

EAU42081

The condition and operation of the front fork must be checked as follows at the intervals specified in the periodic maintenance and lubrication chart.

To check the condition

Check the inner tubes for scratches and damage.

To check the operation

1. Place the vehicle on a level surface and hold it in an upright position. **WARNING! To avoid injury, securely support the vehicle so there is no danger of it falling over.** [EWA10751]
2. While applying the front brake, push down hard on the handlebars several times to check if the front fork compresses and rebounds smoothly.

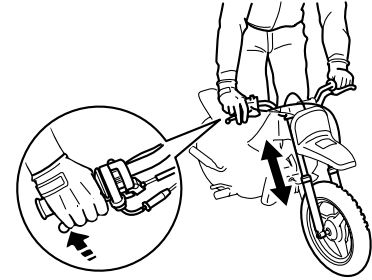

ECA10590

NOTICE

If any damage is found or the front fork does not operate smoothly, have a Yamaha dealer check or repair it.

PERIODIC MAINTENANCE AND ADJUSTMENT

Checking the steering

EAU45511

Worn or loose steering bearings may cause danger. Therefore, the operation of the steering must be checked as follows at the intervals specified in the periodic maintenance and lubrication chart.

1. Place the vehicle on the centerstand. **WARNING! To avoid injury, securely support the vehicle so there is no danger of it falling over.** (EWA10751)
2. Hold the lower ends of the front fork legs and try to move them forward and backward. If any free play can be felt, have a Yamaha dealer check or repair the steering.

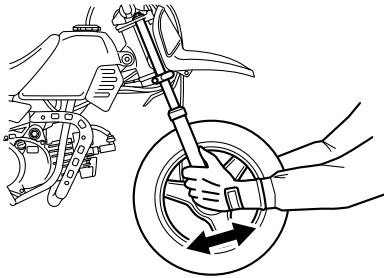

Checking the wheel bearings

EAU23291

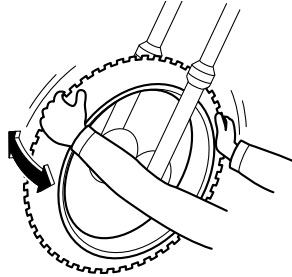

The front and rear wheel bearings must be checked at the intervals specified in the periodic maintenance and lubrication chart. If there is play in the wheel hub or if the wheel does not turn smoothly, have a Yamaha dealer check the wheel bearings.

Front wheel

EAU24360

To remove the front wheel

EAU41023

EWA10821

! WARNING

To avoid injury, securely support the vehicle so there is no danger of it falling over.

1. Place the motorcycle on the centerstand.
2. Disconnect the brake cable at the wheel hub by removing the brake lever free play adjusting nut, then removing the cable from the brake camshaft lever and brake shoe plate.

PERIODIC MAINTENANCE AND ADJUSTMENT

EAU41031

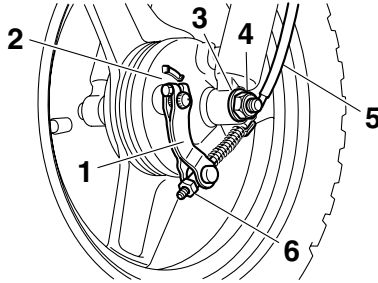

1. Brake camshaft lever
2. Brake shoe plate
3. Washer
4. Axle nut
5. Brake cable
6. Brake lever free play adjusting nut

3. Remove the axle nut and washer.
4. Pull the wheel axle out, and then remove the wheel.

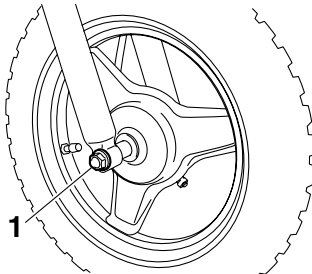

1. Wheel axle

To install the front wheel

1. Install the brake shoe plate into the wheel hub as shown.

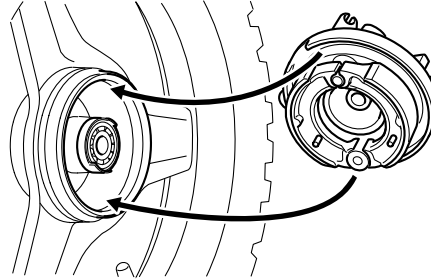

2. Lift the wheel up between the fork legs.

TIP

Make sure that the slot in the brake shoe plate fits over the retainer on the fork leg.

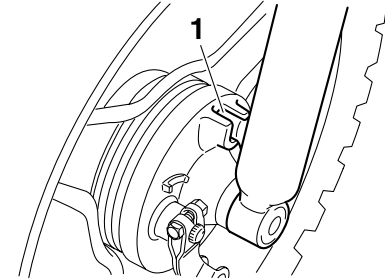

1. Retainer

3. Insert the wheel axle from the right side.
4. Install the washer and axle nut, and then tighten the axle nut to the specified torque.

Tightening torque:

Axle nut:
40 Nm (4.0 m·kgf, 29 ft·lbf)

5. Connect the brake cable at the wheel hub, and then install the brake cable free play adjusting nut.
6. Adjust the brake lever free play. (See page 7-14.)
7. Take the motorcycle off the center-stand so that the front wheel is on the ground.

PERIODIC MAINTENANCE AND ADJUSTMENT

8. Push down hard on the handlebar several times to check for proper fork operation.

Rear wheel

EAU25080

To remove the rear wheel

EAU41084

EWA10821

WARNING

To avoid injury, securely support the vehicle so there is no danger of it falling over.

1. Place the motorcycle on the centerstand.
2. Remove the seat. (See page 4-7.)
3. Remove the muffler bolt and washers. **WARNING! Always let the exhaust system cool prior to touching exhaust components.**
4. Slide the spring clamp down, and then remove the muffler.

[EWA14581]

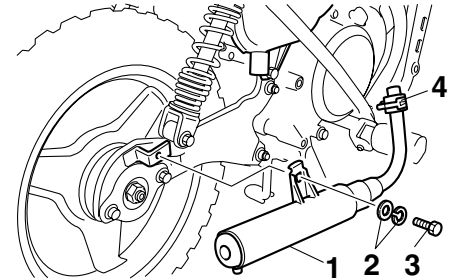

1. Muffler
2. Washer
3. Muffler bolt
4. Spring clamp

5. Remove the exhaust chamber bolt and washers.

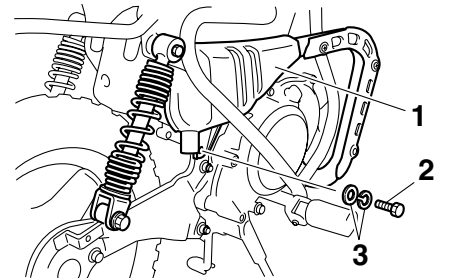

1. Exhaust chamber
2. Exhaust chamber bolt
3. Washer

PERIODIC MAINTENANCE AND ADJUSTMENT

6. Remove the exhaust manifold bolts, and then remove the exhaust chamber, the power reduction plate and the gasket.

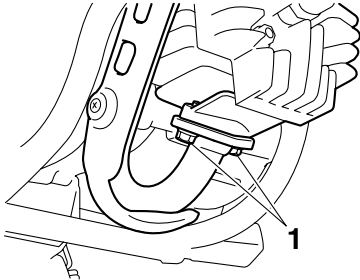

1. Exhaust manifold bolt

7. Remove the right-side rear shock absorber mounting bolt and then tilt the rear shock absorber upward as shown.

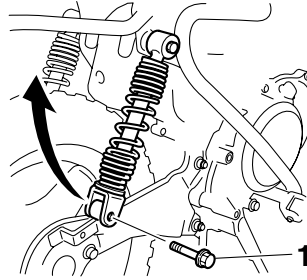

1. Rear shock absorber mounting bolt

8. Remove the axle nut while applying the rear brake.

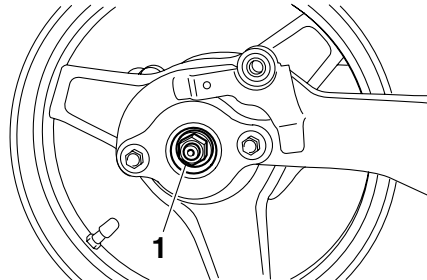

1. Axle nut

9. Remove the rear arm by removing the nuts and washers.

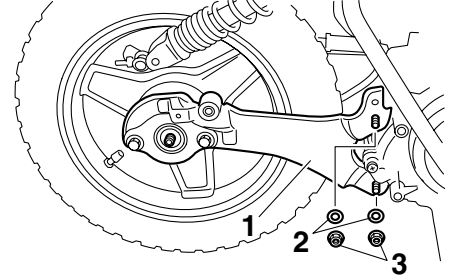

1. Rear arm
2. Washer
3. Rear arm nut

10. Pull the wheel to the right to separate it from the final gear case, and then remove the wheel.

EAU41522

To install the rear wheel

1. Apply a light coating of lithium-soap-based grease to the splines of the final gear case and wheel hub.
2. Install the wheel by inserting it into the wheel hub.
3. Install the rear arm by installing the washers and nuts.
4. Install the axle nut.

PERIODIC MAINTENANCE AND ADJUSTMENT

5. Install the right-side rear shock absorber by installing the mounting bolt.
6. While applying the rear brake, tighten the axle nut to the specified torque.
7. Tighten the rear arm nuts and rear shock absorber mounting bolt to the specified torques.

Tightening torques:

- Axle nut:
60 Nm (6.0 m·kgf, 43 ft·lbf)
- Rear arm nut:
29 Nm (2.9 m·kgf, 21 ft·lbf)
- Rear shock absorber mounting bolt:
23 Nm (2.3 m·kgf, 17 ft·lbf)

8. Install the exhaust chamber by installing the bolt and washers.
9. Install the power reduction plate, a new gasket, and then install the exhaust manifold bolts.
10. Tighten the exhaust manifold bolts and exhaust chamber bolt to the specified torques.

Tightening torques:

- Exhaust manifold bolt:
9 Nm (0.9 m·kgf, 6.5 ft·lbf)
- Exhaust chamber bolt:
18 Nm (1.8 m·kgf, 13 ft·lbf)

11. Install the muffler by sliding the spring clamp up to its original position, and then installing the washers and muffler bolt.

TIP

Make sure that the spring clamp is positioned with the projection side facing inward.

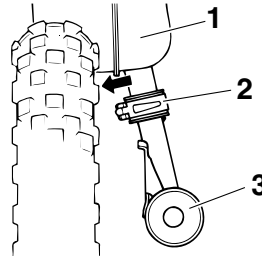

1. Exhaust chamber
2. Spring clamp
3. Muffler

12. Tighten the muffler bolt to the specified torque.

Tightening torque:

- Muffler bolt:
18 Nm (1.8 m·kgf, 13 ft·lbf)

13. Adjust the brake lever free play. (See page 7-14.)
14. Install the seat.

PERIODIC MAINTENANCE AND ADJUSTMENT

EAU25851

Troubleshooting

Although Yamaha motorcycles receive a thorough inspection before shipment from the factory, trouble may occur during operation. Any problem in the fuel, compression, or ignition systems, for example, can cause poor starting and loss of power.

The following troubleshooting chart represents a quick and easy procedure for checking these vital systems yourself. However, should your motorcycle require any repair, take it to a Yamaha dealer, whose skilled technicians have the necessary tools, experience, and know-how to service the motorcycle properly.

Use only genuine Yamaha replacement parts. Imitation parts may look like Yamaha parts, but they are often inferior, have a shorter service life and can lead to expensive repair bills.

EWA15141

WARNING

When checking the fuel system, do not smoke, and make sure there are no open flames or sparks in the area, including pilot lights from water

heaters or furnaces. Gasoline or gasoline vapors can ignite or explode, causing severe injury or property damage.

PERIODIC MAINTENANCE AND ADJUSTMENT

EAU25972

Troubleshooting chart

1. Fuel

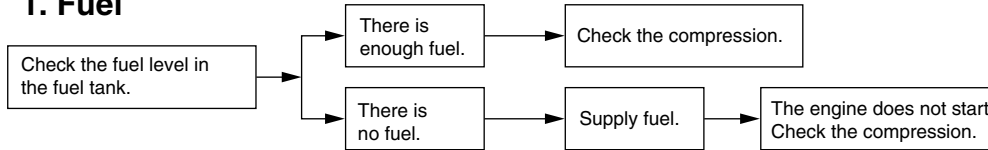

2. Compression

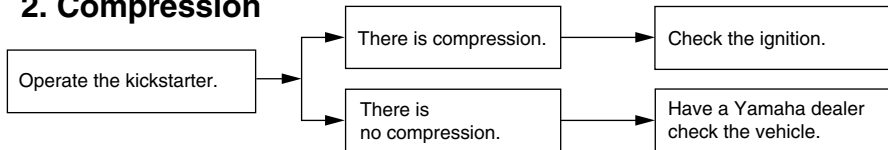

3. Ignition

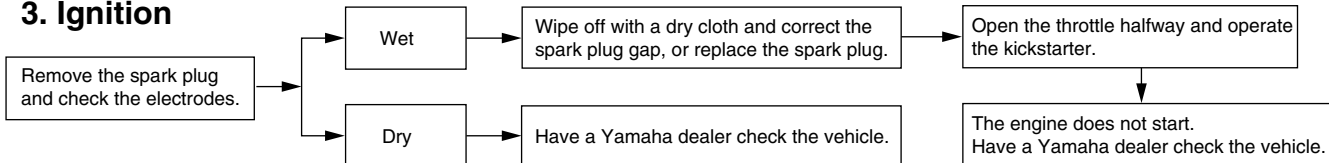

MOTORCYCLE CARE AND STORAGE

Matte color caution

EAU37833

EAU40634

NOTICE

Some models are equipped with matte colored finished parts. Be sure to consult a Yamaha dealer for advice on what products to use before cleaning the vehicle. Using a brush, harsh chemical products or cleaning compounds when cleaning these parts will scratch or damage their surface. Wax also should not be applied to any matte colored finished parts.

ECA15192

Care

While the open design of a motorcycle reveals the attractiveness of the technology, it also makes it more vulnerable. Rust and corrosion can develop even if high-quality components are used. A rusty exhaust pipe may go unnoticed on a car, however, it detracts from the overall appearance of a motorcycle. Frequent and proper care does not only comply with the terms of the warranty, but it will also keep your motorcycle looking good, extend its life and optimize its performance.

Before cleaning

1. Cover the muffler outlet with a plastic bag after the engine has cooled down.
2. Make sure that all caps and covers as well as all electrical couplers and connectors, including the spark plug cap, are tightly installed.
3. Remove extremely stubborn dirt, like oil burnt onto the crankcase, with a degreasing agent and a brush, but never apply such prod-

ucts onto seals, gaskets and wheel axles. Always rinse the dirt and degreaser off with water.

Cleaning

ECA10772

NOTICE

- Avoid using strong acidic wheel cleaners, especially on spoked wheels. If such products are used on hard-to-remove dirt, do not leave the cleaner on the affected area any longer than instructed. Also, thoroughly rinse the area off with water, immediately dry it, and then apply a corrosion protection spray.
- Improper cleaning can damage plastic parts (such as cowlings, panels, windshields, headlight lenses, meter lenses, etc.) and the mufflers. Use only a soft, clean cloth or sponge with water to clean plastic. However, if the plastic parts cannot be thoroughly cleaned with water, diluted mild detergent with water may be used. Be sure to rinse

MOTORCYCLE CARE AND STORAGE

off any detergent residue using plenty of water, as it is harmful to plastic parts.

- Do not use any harsh chemical products on plastic parts. Be sure to avoid using cloths or sponges which have been in contact with strong or abrasive cleaning products, solvent or thinner, fuel (gasoline), rust removers or inhibitors, brake fluid, antifreeze or electrolyte.
- Do not use high-pressure washers or steam-jet cleaners since they cause water seepage and deterioration in the following areas: seals (of wheel and swing-arm bearings, fork and brakes), electric components (couplers, connectors, instruments, switches and lights), breather hoses and vents.
- For motorcycles equipped with a windshield: Do not use strong cleaners or hard sponges as they will cause dulling or scratching. Some cleaning compounds for plastic may leave scratches on the windshield.

Test the product on a small hidden part of the windshield to make sure that it does not leave any marks. If the windshield is scratched, use a quality plastic polishing compound after washing.

After normal use

Remove dirt with warm water, a mild detergent, and a soft, clean sponge, and then rinse thoroughly with clean water. Use a toothbrush or bottlebrush for hard-to-reach areas. Stubborn dirt and insects will come off more easily if the area is covered with a wet cloth for a few minutes before cleaning.

After riding in the rain or near the sea

Since sea salt is extremely corrosive, carry out the following steps after each ride in the rain or near the sea.

1. Clean the motorcycle with cold water and a mild detergent, after the engine has cooled down.
NOTICE: Do not use warm water since it increases the corrosive action of the salt. [ECA10791]

2. Apply a corrosion protection spray on all metal, including chrome- and nickel-plated, surfaces to prevent corrosion.

After cleaning

1. Dry the motorcycle with a chamois or an absorbing cloth.
2. Use a chrome polish to shine chrome, aluminum and stainless-steel parts, including the exhaust system. (Even the thermally induced discoloring of stainless-steel exhaust systems can be removed through polishing.)
3. To prevent corrosion, it is recommended to apply a corrosion protection spray on all metal, including chrome- and nickel-plated, surfaces.
4. Use spray oil as a universal cleaner to remove any remaining dirt.
5. Touch up minor paint damage caused by stones, etc.
6. Wax all painted surfaces.
7. Let the motorcycle dry completely before storing or covering it.

MOTORCYCLE CARE AND STORAGE

WARNING

EWA14501

Contaminants on the brakes or tires can cause loss of control.

- Make sure that there is no oil or wax on the tires.
- If necessary, wash the tires with warm water and a mild detergent. Before riding at higher speeds, test the motorcycle's braking performance and cornering behavior.

NOTICE

ECA10800

- Apply spray oil and wax sparingly and make sure to wipe off any excess.
- Never apply oil or wax to any rubber and plastic parts, but treat them with a suitable care product.
- Avoid using abrasive polishing compounds as they will wear away the paint.

TIP

- Consult a Yamaha dealer for advice on what products to use.

- Washing, rainy weather or humid climates can cause the headlight lens to fog. Turning the headlight on for a short period of time will help remove the moisture from the lens.

Storage

EAU40644

Short-term

Always store your motorcycle in a cool, dry place and, if necessary, protect it against dust with a porous cover. Be sure the engine and the exhaust system are cool before covering the motorcycle.

ECA10810

NOTICE

- Storing the motorcycle in a poorly ventilated room or covering it with a tarp, while it is still wet, will allow water and humidity to seep in and cause rust.
- To prevent corrosion, avoid damp cellars, stables (because of the presence of ammonia) and areas where strong chemicals are stored.

Long-term

Before storing your motorcycle for several months:

1. Follow all the instructions in the "Care" section of this chapter.

MOTORCYCLE CARE AND STORAGE

2. For motorcycles equipped with a fuel cock that has an “S” (stop) position: Turn the fuel cock lever to “S”.
3. Drain the carburetor float chamber by loosening the drain bolt; this will prevent fuel deposits from building up. Pour the drained fuel into the fuel tank.
4. Fill up the fuel tank and add fuel stabilizer (if available) to prevent the fuel tank from rusting and the fuel from deteriorating.
5. Perform the following steps to protect the cylinder, piston rings, etc. from corrosion.
 - a. Remove the spark plug cap and spark plug.
 - b. Pour a teaspoonful of engine oil into the spark plug bore.
 - c. Install the spark plug cap onto the spark plug, and then place the spark plug on the cylinder head so that the electrodes are grounded. (This will limit sparking during the next step.)
 - d. Turn the engine over several times with the starter. (This will coat the cylinder wall with oil.)
 - e. Remove the spark plug cap from the spark plug, and then install the spark plug and the spark plug cap. **WARNING! To prevent damage or injury from sparking, make sure to ground the spark plug electrodes while turning the engine over.** [EWA10951]
6. Lubricate all control cables and the pivoting points of all levers and pedals as well as of the center-stand.
7. Check and, if necessary, correct the tire air pressure, and then lift the motorcycle so that both of its wheels are off the ground. Alternatively, turn the wheels a little every month in order to prevent the tires from becoming degraded in one spot.
8. Cover the muffler outlet with a plastic bag to prevent moisture from entering it.

TIP

Make any necessary repairs before storing the motorcycle.

SPECIFICATIONS

Dimensions:

- Overall length:
1245 mm (49.0 in)
- Overall width:
575 mm (22.6 in)
- Overall height:
715 mm (28.1 in)
- Seat height:
485 mm (19.1 in)
- Wheelbase:
855 mm (33.7 in)
- Ground clearance:
105 mm (4.13 in)
- Minimum turning radius:
1300 mm (51.2 in)

Weight:

- With oil and fuel:
39 kg (86 lb)

Noise and vibration level:

- Noise level (77/311/EEC):
PW50 75.1 dB(A) @2750 r/min
- Vibration on seat (EN1032, ISO5008):
PW50 Will not exceed 0.5 m/s²
- Vibration on handlebar (EN1032, ISO5008):
PW50 Will not exceed 2.5 m/s²

Engine:

- Engine type:
Air cooled 2-stroke
- Cylinder arrangement:
Forward-inclined single cylinder
- Displacement:
49 cm³
- Bore × stroke:
40.0 × 39.2 mm (1.57 × 1.54 in)

- Compression ratio:
6.00 :1
- Starting system:
Kickstarter
- Lubrication system:
Separate lubrication (Yamaha autolube)

Engine oil:

- Type:
YAMALUBE 2S or 2-stroke engine oil (JASO FC grade) or (ISO EG-C or EG-D grade)
- Engine oil quantity:
Quantity:
0.30 L (0.32 US qt, 0.26 Imp.qt)

Transmission oil:

- Type:
YAMALUBE 4 (10W-40) or SAE 10W-40
- Oil change quantity:
0.30 L (0.32 US qt, 0.26 Imp.qt)

Air filter:

- Air filter element:
Wet element

Fuel:

- Recommended fuel:
PW50 Regular unleaded gasoline only
PW50A1 Regular unleaded gasoline only (CAN)
PW50A1 Unleaded gasoline only (AUS)(NZL)
- Fuel tank capacity:
2.0 L (0.53 US gal, 0.44 Imp.gal)

Carburetor:

- Type × quantity:
VM12SC x 1

Spark plug(s):

- Manufacturer/model:
NGK/BPR4HS
- Spark plug gap:
0.6–0.7 mm (0.024–0.028 in)

Clutch:

- Clutch type:
Wet, centrifugal automatic

Transmission:

- Primary reduction system:
Spur gear
- Primary reduction ratio:
63/33 (1.909)
- Secondary reduction system:
Shaft drive
- Secondary reduction ratio:
19/15 × 54/11 (6.218)

Chassis:

- Frame type:
Steel tube backbone
- Caster angle:
25.50 °
- Trail:
50.0 mm (1.97 in)

Front tire:

- Type:
With tube
- Size:
2.50-10 4PR
- Manufacturer/model:
BRIDGESTONE/KNOBBY
- Manufacturer/model:
IRC/KNOBBY

Rear tire:

Type:

With tube

Size:

2.50-10 4PR

Manufacturer/model:

BRIDGESTONE/KNOBBY

Manufacturer/model:

IRC/KNOBBY

Loading:

Maximum rider weight:

25.0 kg (55 lb)

Tire air pressure (measured on cold tires):

Front:

100 kPa (1.00 kgf/cm², 15 psi)

Rear:

100 kPa (1.00 kgf/cm², 15 psi)

Front wheel:

Wheel type:

Panel wheel

Rim size:

10x1.50

Rear wheel:

Wheel type:

Panel wheel

Rim size:

10x1.50

Front brake:

Type:

Drum brake

Operation:

Right hand operation

Rear brake:

Type:

Drum brake

Operation:

Left hand operation

Front suspension:

Type:

Telescopic fork

Spring/shock absorber type:

Coil spring/oil damper

Wheel travel:

60.0 mm (2.36 in)

Rear suspension:

Type:

Unit swing

Spring/shock absorber type:

Coil spring/oil damper

Wheel travel:

50.0 mm (1.97 in)

Electrical system:

Ignition system:

CDI

CONSUMER INFORMATION

EAU40791

Identification numbers

Record the vehicle identification number and model label information in the spaces provided below for assistance when ordering spare parts from a Yamaha dealer or for reference in case the vehicle is stolen.

VEHICLE IDENTIFICATION
NUMBER:

MODEL LABEL INFORMATION:

EAU26400

Vehicle identification number

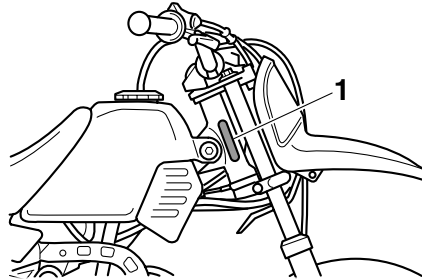

1. Vehicle identification number

The vehicle identification number is stamped into the steering head pipe. Record this number in the space provided.

TIP

The vehicle identification number is used to identify your motorcycle and may be used to register your motorcycle with the licensing authority in your area.

EAU26480

Model label

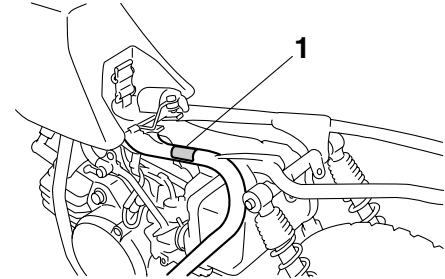

1. Model label

The model label is affixed to the frame under the seat. (See page 4-7.) Record the information on this label in the space provided. This information will be needed when ordering spare parts from a Yamaha dealer.

Vehicle Emission Control Information label (For Canada)

EAU48120

tions related to exhaust emissions as required by federal law, state law and Environment Canada.

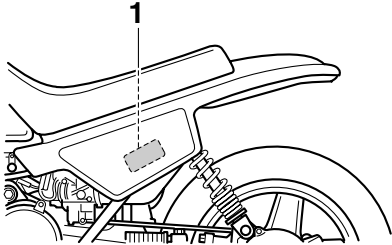

1. Vehicle Emission Control Information label

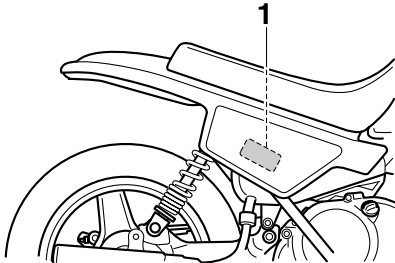

1. Vehicle Emission Control Information label

The Vehicle Emission Control Information label is affixed at the location in the illustration. This label shows specifica-

INDEX

A

- Acceleration and deceleration..... 6-2
- Air filter element, cleaning..... 7-9
- Autolube pump, adjusting 7-16

B

- Brake lever, front..... 4-2
- Brake lever, rear 4-3
- Brake levers, lubricating..... 7-16
- Brake shoes, checking 7-15
- Braking..... 6-2

C

- Cables, checking and lubricating 7-15
- Carburetor, adjusting 7-11
- Care 8-1
- Centerstand, checking and lubricating 7-17

E

- Engine break-in..... 6-3
- Engine idling speed..... 7-11
- Engine oil 4-5
- Engine, starting a warm 6-1
- Engine stop switch 4-1

F

- Front and rear brake lever free play, adjusting 7-14
- Front fork, checking 7-17
- Fuel 4-3
- Fuel cock..... 4-6
- Fuel tank breather hose 4-5
- Fuel tank cap 4-3

H

- Handlebar switch 4-1

I

- Identification numbers 10-1

K

- Kickstarter..... 4-7

L

- Labels, location..... 1-1

M

- Maintenance and lubrication, periodic.... 7-4
- Maintenance, emission control system... 7-3
- Matte color, caution 8-1
- Middle and final gear cases..... 7-9
- Model label 10-1

P

- Parking 6-4
- Part locations 3-1
- Power reduction plate, removing 7-7

S

- Safety information..... 2-1
- Seat 4-7
- Spark arrester, cleaning 7-10
- Spark plug, checking 7-6
- Specifications 9-1
- Speed limiter and power reduction plate 4-1
- Starter (choke) lever 4-6
- Starting and warming up a cold engine 6-1
- Starting off 6-2
- Steering, checking 7-18
- Storage..... 8-3

T

- Throttle cable free play, checking..... 7-12
- Throttle grip and cable, checking and lubricating..... 7-16
- Tires..... 7-12
- Tool kit..... 7-2

- Transmission oil 7-8
- Troubleshooting 7-23
- Troubleshooting chart 7-24

V

- Vehicle Emission Control Information label (For Canada) 10-2
- Vehicle identification number 10-1

W

- Wheel bearings, checking 7-18
- Wheel (front) 7-18
- Wheel (rear) 7-20
- Wheels 7-13



PRINTED ON RECYCLED PAPER

PRINTED IN JAPAN
2010.04-0.7×1 CR
(E)