



OWNER'S MANUAL

JOGGR
JOGGR

CS50Z
CS50

5RW-F8199-E2

Welcome to the Yamaha world CS50Z/CS50, manufacture of high of motorcycling!

As the owner of the CS50Z/CS50, you are benefiting from Yamaha's vast experience and newest technology regarding the design and manufacture of high-quality products, which have earned Yamaha a reputation for dependability.

Please take the time to read this manual thoroughly, so as to enjoy all advantages of your CS50Z/CS50. The owner's manual does not only instruct you in how to operate, inspect and maintain your scooter, but also in how to safeguard yourself and others from trouble and injury.



In addition, the many tips given in this manual will help keep your scooter in the best possible condition. If you have any further questions, do not hesitate to contact your Yamaha dealer.

The Yamaha team wishes you many safe and pleasant rides. So, remember to put safety first!

IMPORTANT MANUAL INFORMATION

EAU34110

Particularly important information is distinguished in this manual by the following notations:

	The Safety Alert Symbol means ATTENTION! BECOME ALERT! YOUR SAFETY IS INVOLVED!
 WARNING	Failure to follow WARNING instructions could result in severe injury or death to the scooter operator, a bystander, or a person inspecting or repairing the scooter.
CAUTION	A CAUTION indicates special precautions that must be taken to avoid damage to the scooter.
NOTE:	A NOTE provides key information to make procedures easier or clearer.

NOTE: _____

- This manual should be considered a permanent part of this scooter and should remain with it even if the scooter is subsequently sold.
- Yamaha continually seeks advancements in product design and quality. Therefore, while this manual contains the most current product information available at the time of printing, there may be minor discrepancies between your scooter and this manual. If you have any questions concerning this manual, please consult your Yamaha dealer.

EWA12410

 **WARNING**

PLEASE READ THIS MANUAL CAREFULLY AND COMPLETELY BEFORE OPERATING THIS SCOOTER.

IMPORTANT MANUAL INFORMATION

EAUS1171

**CS50Z/CS50
OWNER'S MANUAL
©2005 by YAMAHA MOTOR SPAIN S.A.
1st edition, January 2005
All rights reserved.
Any reprinting or unauthorized use
without the written permission of
YAMAHA MOTOR SPAIN S.A.
is expressly prohibited.
Printed in Spain.**

TABLE OF CONTENTS

SAFETY INFORMATION1-1	Acceleration and deceleration.....5-2	Checking and lubricating the throttle grip and cable.....6-14
DESCRIPTION2-1	Braking.....5-2	Adjusting the autolube pump6-14
Left view2-1	Engine break-in.....5-2	Lubricating the front and rear brake levers.....6-14
Right view2-2	Parking.....5-2	Checking and lubricating the centerstand6-14
Controls and instruments2-3		Checking the front fork.....6-15
INSTRUMENT AND CONTROL FUNCTIONS3-1	PERIODIC MAINTENANCE AND MINOR REPAIRS6-1	Checking the steering.....6-15
Main switch/steering lock.....3-1	Periodic maintenance and lubrication chart6-2	Checking the wheel bearings6-15
Indicator lights3-1	Checking the spark plug6-5	Replacing the headlight bulb or a front turn signal light bulb.....6-16
Speedometer unit3-2	Final transmission oil6-6	Replacing a turn signal light bulb or the tail/brake light bulb6-16
Fuel gauge3-3	Coolant (only for liquid-cooled models).....6-6	Replacing the license plate light bulb6-17
Clock.....3-3	To check the coolant level.....6-7	Battery6-17
Handlebar switches3-3	Cleaning the air filter element.....6-8	Replacing the fuse.....6-18
Front brake lever.....3-4	Adjusting the carburetor.....6-9	Troubleshooting6-19
Rear brake lever.....3-4	Adjusting the throttle cable free play.....6-9	Troubleshooting chart.....6-20
Fuel and 2 stroke engine oil tank caps.....3-4	Tires6-9	
2-Stroke engine oil3-5	Adjusting the front brake lever free play.....6-11	SCOOTER CARE AND STORAGE7-1
Kickstarter.....3-6	Adjusting the rear brake lever free play.....6-11	Care7-1
Seat.....3-6	Checking the front brake pads and rear brake shoes6-12	Storage compartment.....7-3
Storage compartment.....3-6	Checking the front brake fluid level6-13	SPECIFICATIONS8-1
PRE-OPERATION CHECKS4-1	Changing the brake fluid6-13	CONSUMER INFORMATION9-1
Pre-operation check list.....4-2	Checking and lubricating the cables6-13	
OPERATION AND IMPORTANT RIDING POINTS5-1		
Starting a cold engine5-1		
Starting off5-1		

SAFETY INFORMATION

1

EAUT1010

SCOOTERS ARE SINGLE TRACK VEHICLES. THEIR SAFE USE AND OPERATION ARE DEPENDENT UPON THE USE OF PROPER RIDING TECHNIQUES AS WELL AS THE EXPERTISE OF THE OPERATOR. EVERY OPERATOR SHOULD KNOW THE FOLLOWING REQUIREMENTS BEFORE RIDING THIS SCOOTER. HE OR SHE SHOULD:

- OBTAIN THOROUGH INSTRUCTIONS FROM A COMPETENT SOURCE ON ALL ASPECTS OF SCOOTER OPERATION.
- OBSERVE THE WARNINGS AND MAINTENANCE REQUIREMENTS IN THE OWNER'S MANUAL.
- OBTAIN QUALIFIED TRAINING IN SAFE AND PROPER RIDING TECHNIQUES.
- OBTAIN PROFESSIONAL TECHNICAL SERVICE AS INDICATED BY THE OWNER'S MANUAL AND/OR WHEN MADE NECESSARY BY MECHANICAL CONDITIONS.

Safe riding

- Always make pre-operation checks. Careful checks may help prevent an accident.
- This scooter is designed to carry the operator and passenger.

NOTE:

Although this scooter is designed to carry a passenger, always comply with the local regulations.

- The failure of motorists to detect and recognize scooters in traffic is the predominating cause of automobile/scooter accidents. Many accidents have been caused by an automobile driver who did not see the scooter. Making yourself conspicuous appears to be very effective in reducing the chance of this type of accident.

Therefore:

- Wear a brightly colored jacket.
- Use extra caution when approaching and passing through intersections, since intersections are the most likely places for scooter accidents to occur.

- Ride where other motorists can see you. Avoid riding in another motorist's blind spot.
- Many accidents involve inexperienced operators. In fact, many operators who have been involved in accidents do not even have a current driver's license.
- Make sure that you are qualified and that you only lend your scooter to other qualified operators.
- Know your skills and limits. Staying within your limits may help you to avoid an accident.
- We recommend that you practice riding your scooter where there is no traffic until you have become thoroughly familiar with the scooter and all of its controls.
- Many accidents have been caused by error of the scooter operator. A typical error made by the operator is veering wide on a turn due to EXCESSIVE SPEED or under cornering (insufficient lean angle for the speed).
- Always obey the speed limit

and never travel faster than warranted by road and traffic conditions.

- Always signal before turning or changing lanes. Make sure that other motorists can see you.
- The posture of the operator and passenger is important for proper control.
- The operator should keep both hands on the handlebar and both feet on the footboard during operation to maintain control of the scooter.
- The passenger should always hold onto the operator, the seat strap or grab bar, if equipped, with both hands and keep both feet on the passenger footrests.
- Never carry a passenger unless he or she can firmly place both feet on the passenger footrests.
- Never ride under the influence of alcohol or other drugs.
- This scooter is designed for on-road use only. It is not suitable for off-road use.

Protective apparel

The majority of fatalities from scooter accidents are the result of head injuries. The use of a safety helmet is the single most critical factor in the prevention or reduction of head injuries.

- Always wear an approved helmet.
- Wear a face shield or goggles. Wind in your unprotected eyes could contribute to an impairment of vision which could delay seeing a hazard.
- The use of a jacket, substantial shoes, trousers, gloves, etc., is effective in preventing or reducing abrasions or lacerations.
- Never wear loose-fitting clothes, otherwise they could catch on the control levers or wheels and cause injury or an accident.
- Never touch the engine or exhaust system during or after operation. They become very hot and can cause burns. Always wear protective clothing that covers your legs, ankles, and feet.
- Passengers should also observe the above precautions.

Modifications

Modifications made to this scooter not approved by Yamaha, or the removal of original equipment, may render the scooter unsafe for use and may cause severe personal injury. Modifications may also make your scooter illegal to use.

Loading and accessories

Adding accessories or cargo to your scooter can adversely affect stability and handling if the weight distribution of the scooter is changed. To avoid the possibility of an accident, use extreme caution when adding cargo or accessories to your scooter. Use extra care when riding a scooter that has added cargo or accessories. Here are some general guidelines to follow if loading cargo or adding accessories to your scooter:

Loading

The total weight of the operator, passenger, accessories and cargo must not exceed the maximum load limit of CS50Z 158kg (348,39lb), CS50 161kg (355lb). When loading within this weight limit, keep the following in mind:

SAFETY INFORMATION

1

- Cargo and accessory weight should be kept as low and close to the scooter as possible. Make sure to distribute the weight as evenly as possible on both sides of the scooter to minimize imbalance or instability.
- Shifting weights can create a sudden imbalance. Make sure that accessories and cargo are securely attached to the scooter before riding. Check accessory mounts and cargo restraints frequently.
- Never attach any large or heavy items to the handlebar, front fork, or front fender. Such items can create unstable handling or a slow steering response.

Accessories

Genuine Yamaha accessories have been specifically designed for use on this scooter. Since Yamaha cannot test all other accessories that may be available, you must personally be responsible for the proper selection, installation and use of non-Yamaha accessories. Use extreme caution when selecting and installing any accessories.

Keep the following guidelines in mind, as well as those provided under “Loading” when mounting accessories.

- Never install accessories or carry cargo that would impair the performance of your scooter. Carefully inspect the accessory before using it to make sure that it does not in any way reduce ground clearance or cornering clearance, limit suspension travel, steering travel or control operation, or obscure lights or reflectors.
- Accessories fitted to the handlebar or the front fork area can create instability due to improper weight distribution or aerodynamic changes. If accessories are added to the handlebar or front fork area, they must be as lightweight as possible and should be kept to a minimum.
- Bulky or large accessories may seriously affect the stability of the scooter due to aerodynamic effects. Wind may attempt to lift the scooter, or the scoo-

ter may become unstable in cross winds. These accessories may also cause instability when passing or being passed by large vehicles.

- Certain accessories can displace the operator from his or her normal riding position. This improper position limits the freedom of movement of the operator and may limit control ability, therefore, such accessories are not recommended.
- Use caution when adding electrical accessories. If electrical accessories exceed the capacity of the scooter’s electrical system an electric failure could result, which could cause a dangerous loss of lights or engine power.

Gasoline and exhaust gas

- **GASOLINE IS HIGHLY FLAMMABLE:**
 - Always turn the engine off when refueling.
 - Take care not to spill any gasoline on the engine or exhaust system when refueling.

- Never refuel while smoking or in the vicinity of an open flame.
- Never start the engine or let it run for any length of time in a closed area. The exhaust fumes are poisonous and may cause loss of consciousness and death within a short time. Always operate your scooter in an area that has adequate ventilation.
- Always turn the engine off before leaving the scooter unattended and remove the key from the main switch. When parking the scooter, note the following:
 - The engine and exhaust system may be hot, therefore, park the scooter in a place where pedestrians or children are not likely to touch these hot areas.
 - Do not park the scooter on a slope or soft ground, otherwise it may fall over.
 - Do not park the scooter near a flammable source (e.g., a kerosene heater, or near an open flame), otherwise it could catch fire.

- If you should swallow any gasoline, inhale a lot of gasoline vapor, or allow gasoline to get into your eyes, see your doctor immediately. If any gasoline spills on your skin or clothing, immediately wash the affected area with soap and water and change your clothes.

EAU10360

Further safe-riding points

- Be sure to signal clearly when making turns.
- Braking can be extremely difficult on a wet road. Avoid hard braking, because the scooter could slide. Apply the brakes slowly when stopping on a wet surface.
- Slow down as you approach a corner or turn. Once you have completed a turn, accelerate slowly.
- Be careful when passing parked cars. A driver might not see you and open a door in your path.
- Railroad crossings, streetcar rails, iron plates on road construction sites, and manhole

covers become extremely slippery when wet. Slow down and cross them with caution. Keep the scooter upright, otherwise it could slide out from under you.

- The brake lining could get wet when you wash the scooter. After washing the scooter, check the brakes before riding.
- Always wear a helmet, gloves, trousers (tapered around the cuff and ankle so they do not flap), and a bright colored jacket.
- Do not carry too much luggage on the scooter. An overloaded scooter is unstable. Use a strong cord to secure any luggage to the carriers. A loose load will affect the stability of the scooter and could divert your attention from the road.

DESCRIPTION

EAU10410

Left view

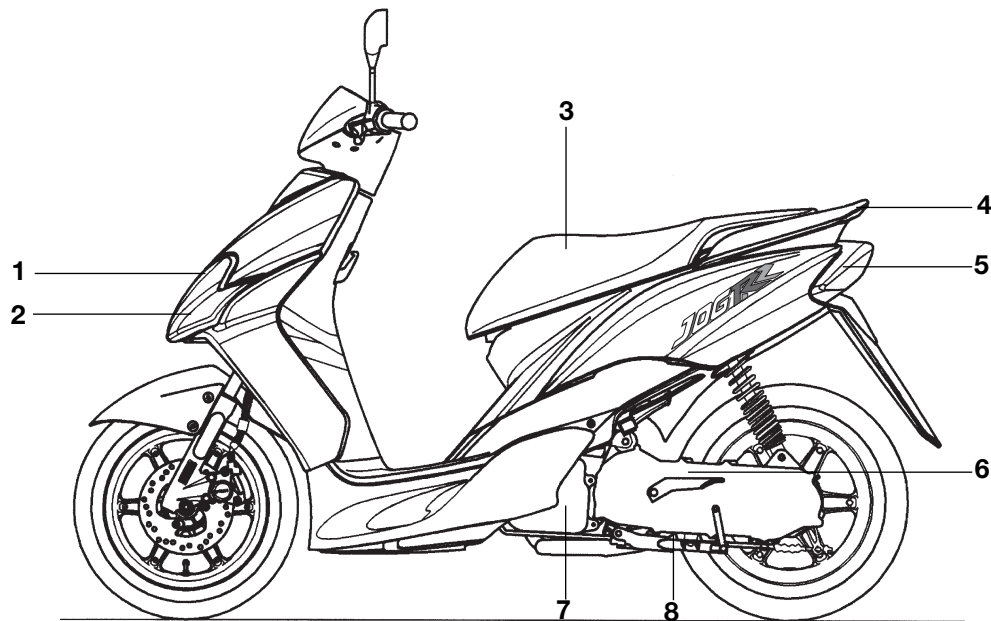

- 1. Headlight (page 6-16)
- 2. Front blinker (page 6-16)
- 3. Seat (page 3-6)
- 4. Handle

- 5. Left rear blinker (page 6-16)
- 6. kickstarter (page 3-6)
- 7. Air filter (page 6-8)
- 8. Center stand (page 6-14)

Right view

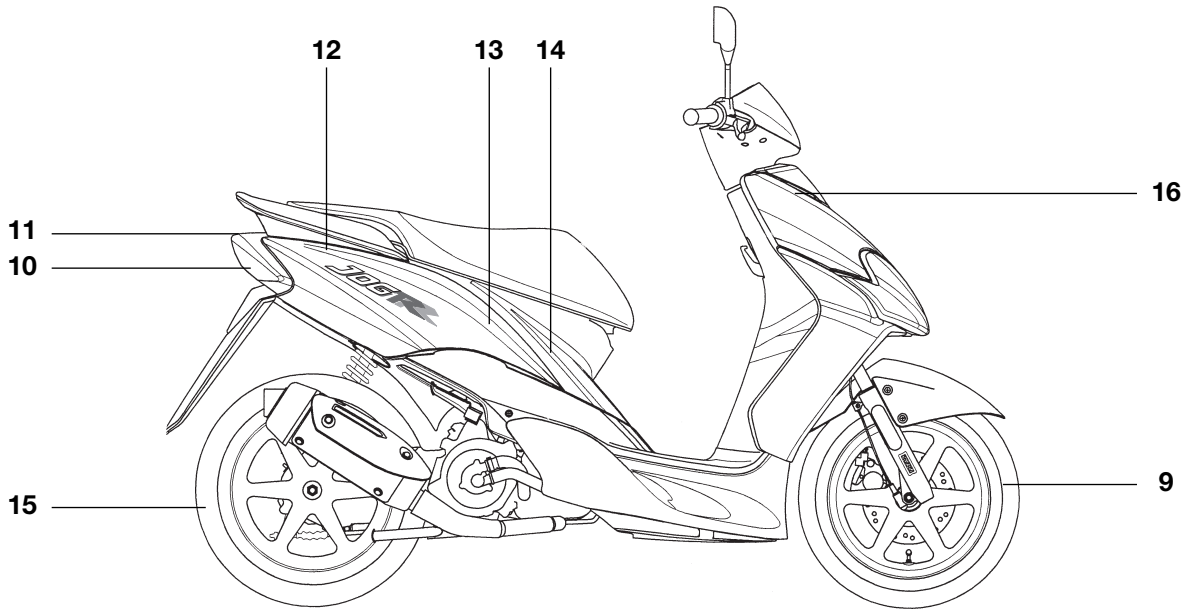

- 9. Wheel (Front) (page 6-15)
- 10. Right rear blinker (page 6-16)
- 11. Tail light (page 6-16)
- 12. Fuel tank (page 3-4)

- 13. Storage compartment (page 3-6)
- 14. Battery (page 6-17)
- 15. Wheel (Rear) (page 6-15)
- 16. Coolant reservoir (page 6-7)

DESCRIPTION

EAU10430

Controls and instruments

2

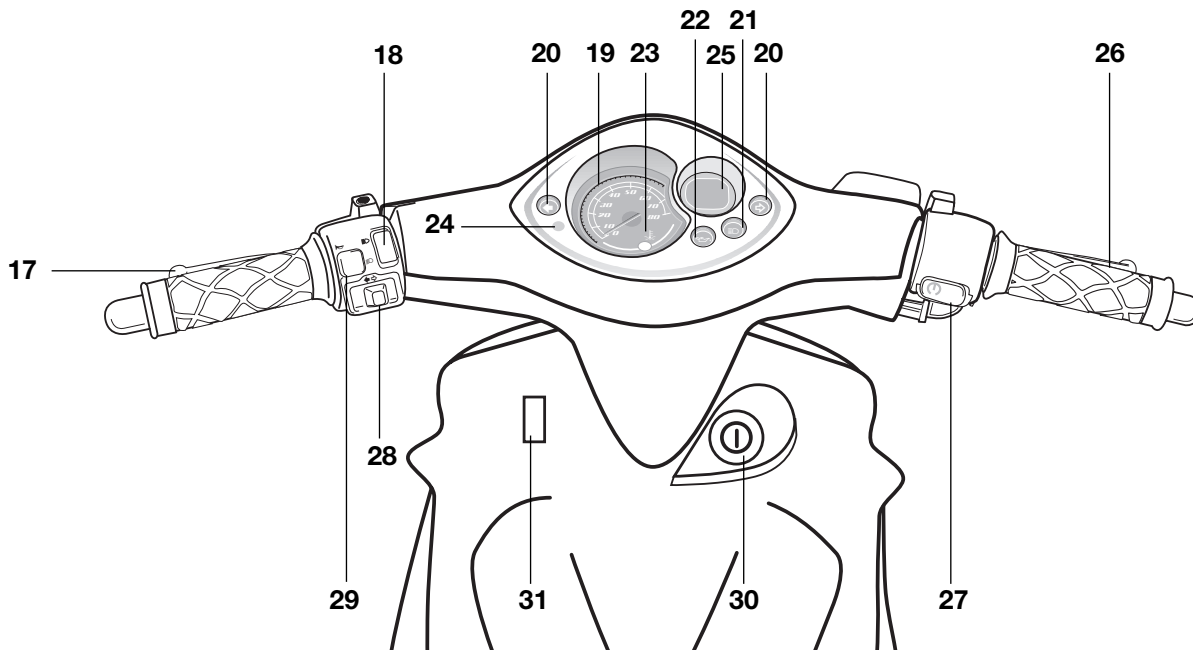

17. Rear brake lever (page 6-11)

18. Left handlebar switch (page 3-3)

19. Speedometer (page 3-2)

20. Turn signal indicator light (page 3-1)

21. High beam light (page 3-1)

22. Oil level warning light (page 3-1)

23. Coolant temperature warning light (page 3-1)

24. "TRIP" button (page 3-2)

25. Fuel gauge (page 3-3)

26. Front brake lever (page 3-4)

27. Right handlebar switch (page 3-3)

28. Turn signal switch (page 3-3)

29. Horn switch (page 3-3)

30. Main switch (page 3-1)

31. Coolant level gauge window (page 6-7)

INSTRUMENT AND CONTROL FUNCTIONS

EAU10460

Main switch/steering lock

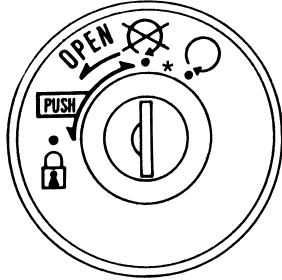

The main switch/steering lock controls the ignition and lighting systems, and is used to lock the steering. The various positions are described below.

EAU10630

ON

All electrical systems are supplied with power, and the engine can be started. The key cannot be removed.

EAU10660

OFF

All electrical systems are off. The key can be removed.

EAU10670

*

The 2-stroke engine oil level warning light should come on. (See page 3-1.)

EAU10680

LOCK

The steering is locked, and all electrical systems are off. The key can be removed.

To lock the steering

1. Turn the handlebars all the way to the left.
2. Push the key in from the “OFF” position, and then turn it to “LOCK” while still pushing it.
3. Remove the key.

To unlock the steering

Push the key in, and then turn it to “OFF” while still pushing it.

EWA10060

⚠ WARNING

Never turn the key to “OFF” or “LOCK” while the vehicle is moving, otherwise the electrical systems will be switched off, which may result in loss of control or an accident. Make sure that the vehicle is stopped before turning the key to “OFF” or “LOCK”.

3

EAU10980

Indicator lights

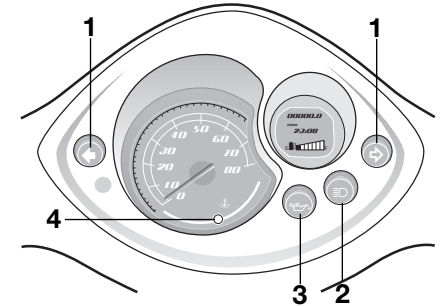

1. Turn signal indicator lights “↔”
2. High beam indicator light “≡”
3. Oil level warning light “⊖”
4. Coolant temperature warning light “⊡”

INSTRUMENT AND CONTROL FUNCTIONS

EAU11030

Turn signal indicator lights “+” and “-”

The corresponding indicator light flashes when the turn signal switch is pushed to the left or right.

EAU11080

3 High beam indicator light “≡D”

This indicator light comes on when the high beam of the headlight is switched on.

EAU11130

2-stroke engine oil level warning light “”

This warning light comes on when the 2-stroke engine oil level is low. The electrical circuit of the warning light can be checked according to the following procedure.

1. Turn the key to “ON”.
2. Shift the transmission into the neutral position.
3. If the warning light does not come on, have a Yamaha dealer check the electrical circuit.

ECA11570

CAUTION

Do not operate the motorcycle until you know that the 2-stroke engine oil level is sufficient.

NOTE:

Even if the 2-stroke engine oil level is sufficient, the warning light may flicker when riding on a slope or during sudden acceleration or deceleration, but this is not a malfunction.

EAU11430

Coolant temperature warning light “”

This warning light comes on when the engine overheats. When this occurs, stop the engine immediately and allow the engine to cool.

ECA10020

CAUTION

Do not operate the engine if it is overheated.

EAU1090

Speedometer unit

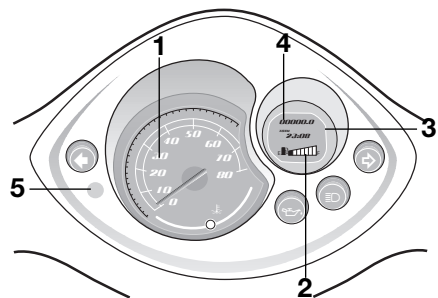

1. Speedometer unit
2. Fuel gauge
3. Clock
4. Odometer (TOTAL/TRIP)
5. "TRIP" button

The speedometer unit is equipped with a speedometer, an odometer and a tripmeter. The speedometer shows riding speed. The odometer shows the total distance traveled. The tripmeter shows the distance traveled since it was last set to zero. Pushing the reset button switches the display between the odometer mode “TOTAL” and the tripmeter mode “TRIP”. To reset the tripmeter, enter the “TRIP” mode, and then hold down

INSTRUMENT AND CONTROL FUNCTIONS

the reset button for at least two seconds.

The tripmeter can be used together with the fuel gauge to estimate the distance that can be traveled with a full tank of fuel. This information will enable you to plan future fuel stops.

EAU12140

Fuel gauge

The fuel gauge indicates the amount of fuel in the fuel tank. The needle moves towards “E” (Empty) as the fuel level decreases. When the needle reaches “E”, refuel as soon as possible.

NOTE: _____
Do not allow the fuel tank to empty itself completely.

EAU1010

Clock

To set the clock

1. Turn the key to “O”.
2. Set the odometer/tripmeter display to “TOTAL” by pushing the “SET” button.

3. Push the “SET” button for at least two seconds.
4. When the hours digits start flashing, push the “SET” button to set the hours.
5. Push the “SET” button for at least two seconds and the minutes digits will start flashing.
6. Push the “SET” button to set the minutes.
7. Push the “SET” button for at least two seconds to start the clock and return to the odometer/tripmeter mode.

NOTE: _____
The clock is displayed only when the key is in the “O” position.

EAU12343

Handlebar switches

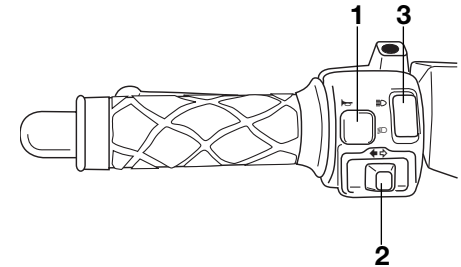



1. Horn switch
2. Turn signal switch
3. Dimmer switch

3

EAU12400

Dimmer switch “/”

Set this switch to “” for the high beam and to “” for the low beam.

EAU12440

Turn signal switch “TURN”

To signal a right-hand turn, push this switch to the right. To signal a left-hand turn, push this switch to the left. When released, the switch returns to the center position. To cancel the turn signal lights, push the switch in after it has returned to the center position.

INSTRUMENT AND CONTROL FUNCTIONS

Horn switch “”

Press this switch to sound the horn.

EAU12500

Start switch “START”

EAU12700

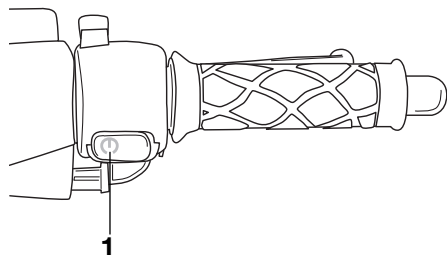

1. Start switch

Push this switch while applying the front or rear brake to crank the engine with the starter.

CAUTION

See page 5-1 for starting instructions prior to starting the engine.

ECA10050

Front brake lever

EAU12900

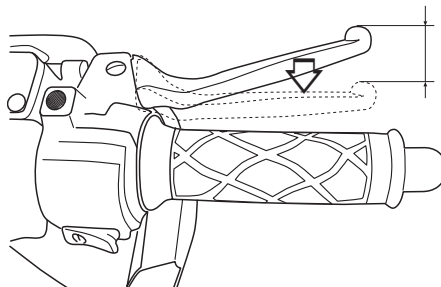

The front brake lever is located on the right handlebar grip. To apply the front brake, pull this lever toward the handlebar grip.

Rear brake lever

EAU12950

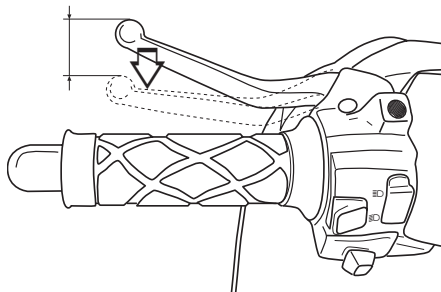

The rear brake lever is located on the left handlebar grip. To apply the rear brake, pull this lever toward the handlebar grip.

Fuel and 2-stroke engine oil tank caps

EAU13200

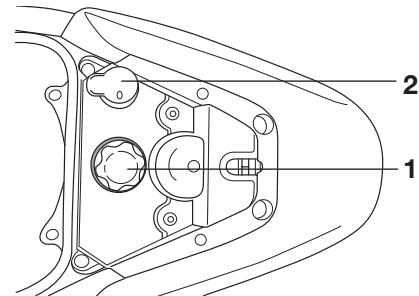

1. Fuel tank cap
2. Engine oil tank cap

The fuel tank cap and the 2-stroke engine oil tank cap are located under the seat. (See page 3-6.)

Fuel tank cap

To remove the fuel tank cap, turn it counterclockwise, and then pull it off. To install the fuel tank cap, turn it clockwise.

INSTRUMENT AND CONTROL FUNCTIONS

2-stroke engine oil tank cap

To remove the 2-stroke engine oil tank cap, pull it off.

To install the 2-stroke engine oil tank cap, push it into the oil tank opening.

EWA10880

⚠ WARNING

- Do not overfill the fuel tank, otherwise it may overflow when the fuel warms up and expands.
- Avoid spilling fuel on the hot engine.

EWA10140

⚠ WARNING

Make sure that the fuel and 2-stroke engine oil tank caps are properly installed before riding the scooter.

ECA10070

CAUTION

Immediately wipe off spilled fuel with a clean, dry, soft cloth, since fuel may deteriorate painted surfaces or plastic parts.

EAU13220

Fuel

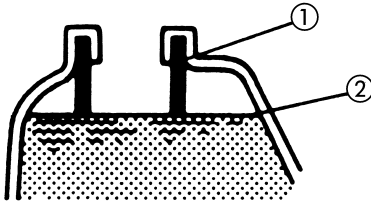

1. Refill pipe
2. Fuel level

Make sure that there is sufficient fuel in the tank. When refueling, be sure to insert the pump nozzle into the fuel tank filler hole and to fill the tank to the bottom of the filler tube as shown.

Recommended fuel:
REGULAR UNLEADED GASOLINE ONLY

Fuel tank capacity:
5,5L (1,21 US gal) (4,8Imp.gal)

Fuel reserve amount:
1,9L(0,42US gal) (1,67Imp.gal)

EAU13270

Your Yamaha engine has been designed to use regular unleaded gasoline with a research octane number of 91 or higher. If knocking (or pinging)

occurs, use a gasoline of a different brand or premium unleaded fuel. Use of unleaded fuel will extend spark plug life and reduce maintenance costs.

EAU13460

2-stroke engine oil

Make sure that there is sufficient oil in the 2-stroke engine oil tank. Add the recommended 2-stroke engine oil if necessary.

NOTE:

Make sure that the 2-stroke engine oil tank cap is properly installed.

Recommended oil:

Yamalube 2 or equivalent 2-stroke engine oil (JASO grade "FC", or ISO grades "EG-C" or "EG-D")

Oil quantity:

1,4L (0,31 US qt)(1,23 Imp.qt)

INSTRUMENT AND CONTROL FUNCTIONS

EAU1050

Kickstarter

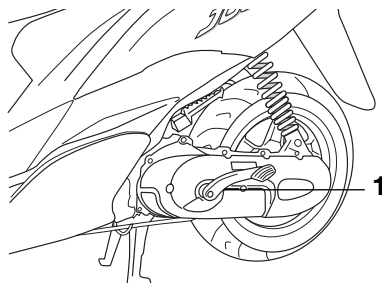

1. Kickstarter

To start the engine, push the kickstarter down lightly with your foot until the gears engage, and then push it down smoothly but forcefully.

EAU13931

Seat

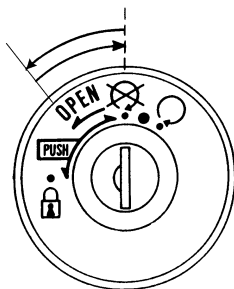

To open the seat

1. Place the scooter on the centerstand.
2. Insert the key into the main switch, and then turn it counter-clockwise.

NOTE:

Do not push inward when turning the key.

3. Fold the seat up.

To close the seat

1. Fold the seat down, and then push it down to lock it in place.
2. Remove the key from the main switch if the scooter will be left unattended.

NOTE:

Make sure that the seat is properly secured before riding.

EAU14440

Storage compartment

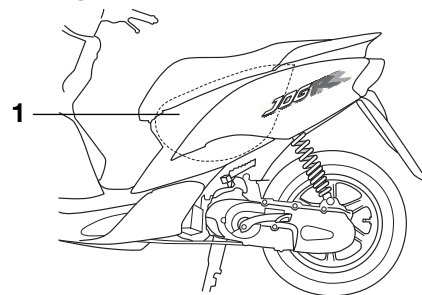

1. Storage compartment

EAU14510

Storage compartment

There is a storage compartment under the seat. (See page 3-6.)

EWA10960

WARNING

- Do not exceed the load limit of 3,5 kg (7,4 lb) for the storage compartment.
- Do not exceed the maximum load of 158kg (348,4lb) CS50Z or 161kg (355lb) CS50 for the vehicle.

INSTRUMENT AND CONTROL FUNCTIONS

ECA10080

CAUTION

Keep the following points in mind when using the storage compartment.

- Since the storage compartment accumulates heat when exposed to the sun, do not store anything susceptible to heat inside it.
- To avoid humidity from spreading through the storage compartment, wrap wet articles in a plastic bag before storing them in the compartment.
- Since the storage compartment may get wet while the scooter is being washed, wrap any articles stored in the compartment in a plastic bag.
- Do not keep anything valuable or breakable in the storage compartment.

To store a helmet in the storage compartment, place the helmet upside-down with the front facing forward.

NOTE:

- Some helmets cannot be stored in the storage compartment because of their size or shape.
- Do not leave your scooter unattended with the seat open.

PRE-OPERATION CHECKS

EAU15591

The condition of a vehicle is the owner's responsibility. Vital components can start to deteriorate quickly and unexpectedly, even if the vehicle remains unused (for example, as a result of exposure to the elements). Any damage, fluid leakage or loss of tire air pressure could have serious consequences. Therefore, it is very important, in addition to a thorough visual inspection, to check the following points before each ride.

4

NOTE: _____

Pre-operation checks should be made each time the vehicle is used. Such an inspection can be accomplished in a very short time; and the added safety it assures is more than worth the time involved.

EWA11150

⚠ WARNING _____

If any item in the Pre-operation check list is not working properly, have it inspected and repaired before operating the vehicle.

PRE-OPERATION CHECKS

EAU15603

Pre-operation check list

ITEM	CHECKS	PAGE
Fuel	<ul style="list-style-type: none">• Check fuel level in fuel tank.• Refuel if necessary.• Check fuel line for leakage.	3-3, 3-4
2-stroke engine oil	<ul style="list-style-type: none">• Check oil level in oil tank.• If necessary, add recommended oil to specified level.• Check vehicle for oil leakage.	3-4, 3-5
Transmission oil	<ul style="list-style-type: none">• Check oil level in transmission case.• If necessary, add recommended oil to specified level.	6-6
Front brake	<ul style="list-style-type: none">• Check operation.• If soft or spongy, have Yamaha dealer bleed hydraulic system.• Check brake pads for wear.• Replace if necessary.• Check fluid level in reservoir.• If necessary, add recommended brake fluid to specified level.• Check hydraulic system for leakage.	6-11, 6-12, 6-13, 3-4
Rear brake	<ul style="list-style-type: none">• Check operation.• Lubricate cable if necessary.• Check lever free play.• Adjust if necessary.	3-4, 6-11, 6-12
Throttle grip	<ul style="list-style-type: none">• Make sure that operation is smooth.• Check cable free play.• If necessary, have Yamaha dealer adjust cable free play and lubricate cable and grip housing.	6-9, 6-14
Wheels and tires	<ul style="list-style-type: none">• Check for damage.• Check tire condition and tread depth.• Check air pressure.• Correct if necessary.	6-9, 6-15
Brake levers	<ul style="list-style-type: none">• Make sure that operation is smooth.• Lubricate lever pivoting points if necessary.	3-4, 6-11, 6-14
Centerstand	<ul style="list-style-type: none">• Make sure that operation is smooth.• Lubricate pivot if necessary.	6-14

PRE-OPERATION CHECKS

ITEM	CHECKS	PAGE
Chassis fasteners	<ul style="list-style-type: none">• Make sure that all nuts, bolts and screws are properly tightened.• Tighten if necessary.	—
Instruments, lights, signals and switches	<ul style="list-style-type: none">• Check operation.• Correct if necessary.	—
Coolant	<ul style="list-style-type: none">• Check coolant level in reservoir.• If necessary, add recommended coolant to specified level.• Check cooling system for leakage.	6-6, 6-7

OPERATION AND IMPORTANT RIDING POINTS

EAU15980
EWA10870

WARNING

- Become thoroughly familiar with all operating controls and their functions before riding. Consult a Yamaha dealer regarding any control or function that you do not thoroughly understand.
- Never start the engine or operate it in a closed area for any length of time. Exhaust fumes are poisonous, and inhaling them can cause loss of consciousness and death within a short time. Always make sure that there is adequate ventilation.
- For safety, always start the engine with the centerstand down.

Starting a cold engine

EAU16560

ECA10250

CAUTION

See page 5-2 for engine break-in instructions prior to operating the vehicle for the first time.

1. Turn the key to “*”, and when the oil level warning light comes on, turn it to “ON”.

ECA10240

CAUTION

If the oil level warning light does not come on, have a Yamaha dealer check the electrical circuit.

2. Close the throttle completely.
3. While applying the front or rear brake, start the engine by pushing the start switch or by pushing the kickstarter lever down.

NOTE:

If the engine fails to start by pushing the start switch, release the switch, wait a few seconds, and then try again. Each starting attempt should be as short as possible to preserve the battery. Do not crank the engine more than 5 seconds on any one

attempt. If the engine does not start with the starter motor, try using the kickstarter.

ECA11040

CAUTION

For maximum engine life, never accelerate hard when the engine is cold!

EAU16760

Starting off

NOTE:

Before starting off, allow the engine to warm up.

1. While pulling the rear brake lever with your left hand and holding the grab bar with your right hand, push the scooter off the centerstand.
2. Sit astride the seat, and then adjust the rear view mirrors.
3. Switch the turn signal on.
4. Check for oncoming traffic, and then slowly turn the throttle grip (on the right) in order to take off.
5. Switch the turn signal off.

OPERATION AND IMPORTANT RIDING POINTS

Acceleration and deceleration

EAU16780

The speed can be adjusted by opening and closing the throttle. To increase the speed, turn the throttle grip in direction (a). To reduce the speed, turn the throttle grip in direction (b).

Braking

EAU16791

1. Close the throttle completely.
2. Apply both front and rear brakes simultaneously while gradually increasing the pressure.

EWA10300

WARNING

- **Avoid braking hard or suddenly (especially when leaning over to one side), otherwise the scooter may skid or overturn.**
- **Railroad crossings, streetcar rails, iron plates on road construction sites, and manhole covers become extremely slippery when wet. Therefore, slow down when approaching such areas and cross them with caution.**

- **Keep in mind that braking on a wet road is much more difficult.**
- **Ride slowly down a hill, as braking downhill can be very difficult.**

Engine break-in

EAU16830

There is never a more important period in the life of your engine than the period between 0 and 1000 km (600 mi). For this reason, you should read the following material carefully. Since the engine is brand new, do not put an excessive load on it for the first 1000 km (600 mi). The various parts in the engine wear and polish themselves to the correct operating clearances. During this period, prolonged full-throttle operation or any condition that might result in engine overheating must be avoided.

0~150 km (0~90 mi)

EAUT1110

Avoid operation above 1/3 throttle. Stop the engine and let it cool for 5 to 10 minutes after every hour of operation. Vary the speed of the scooter

from time to time. Do not operate it at one set throttle position.

150~500 km (90~300 mi)

Avoid prolonged operation above 1/2 throttle.

500~1000 km (300~600 mi)

Avoid cruising speeds in excess of 3/4 throttle.

ECAT1010

CAUTION

After 1000 km (600 mi) of operation, be sure to replace the final gear oil.

1000 km (600 mi) and beyond

Avoid prolonged full throttle operation. Vary speeds occasionally.

ECA10270

CAUTION

If any engine trouble should occur during the engine break-in period, immediately have a Yamaha dealer check the vehicle.

EAU17200

Parking

When parking, stop the engine, and then remove the key from the main switch.

OPERATION AND IMPORTANT RIDING POINTS

EWA10310

WARNING

- Since the engine and exhaust system can become very hot, park in a place where pedestrians or children are not likely to touch them.
 - Do not park on a slope or on soft ground, otherwise the vehicle may overturn.
-

PERIODIC MAINTENANCE AND MINOR REPAIR

EAU17280

Safety is an obligation of the owner. Periodic inspection, adjustment and lubrication will keep your vehicle in the safest and most efficient condition possible. The most important points of inspection, adjustment, and lubrication are explained on the following pages.

The intervals given in the periodic maintenance and lubrication chart should be simply considered as a general guide under normal riding conditions. However, **DEPENDING ON THE WEATHER, TERRAIN, GEOGRAPHICAL LOCATION, AND INDIVIDUAL USE, THE MAINTENANCE INTERVALS MAY NEED TO BE SHORTENED.**

EWA10320

WARNING

If you are not familiar with maintenance work, have a Yamaha dealer do it for you.

EWA10330

WARNING

This scooter is designed for use on paved roads only. If this scooter is operated in abnormally dusty,

muddy or wet conditions, the air filter element should be cleaned or replaced more frequently, otherwise rapid engine wear may result. Consult a Yamaha dealer for proper maintenance intervals.

PERIODIC MAINTENANCE AND MINOR REPAIR

EAU17710

Periodic maintenance and lubrication chart

NOTE:

- The annual checks must be performed every year, except if a kilometer-based maintenance is performed instead.
- From 30000 km, repeat the maintenance intervals starting from 6000 km.
- Items marked with an asterisk should be performed by a Yamaha dealer as they require special tools, data and technical skills.

NO	ITEM	CHEK OR MAINTENANCE JOB	ODOMETER READING (x 1000 Km)					ANNUAL
			1	6	12	18	24	CHECK
1	* Fuel line	<ul style="list-style-type: none"> • Check fuel and vacuum hoses for cracks or damage. 		√	√	√	√	√
2	Spark plug	<ul style="list-style-type: none"> • Check condition. • Clean and regap. • Replace. 		√		√		
3	Air filter element	<ul style="list-style-type: none"> • Clean. • Replace. 		√		√		
4	* Front brake	<ul style="list-style-type: none"> • Check operation, fluid level and vehicle for fluid leakage. • Replace brake pads. 	√	√	√	√	√	√
			Whenever worn to the limit					
5	* Rear brake	<ul style="list-style-type: none"> • Check operation and adjust brake lever free play. • Replace brake shoes. 	√	√	√	√	√	√
			Whenever worn to the limit					
6	* Brake hose	<ul style="list-style-type: none"> • Check for cracks or damage. • Replace. 		√	√	√	√	√
			Every 4 years					
7	* Wheels	<ul style="list-style-type: none"> • Check runout and for damage. 		√	√	√	√	
8	* Tires	<ul style="list-style-type: none"> • Check tread depth and for damage. • Replace if necessary. • Check air pressure. • Correct if necessary. 		√	√	√	√	√

PERIODIC MAINTENANCE AND MINOR REPAIR

NO	ITEM	CHEK OR MAINTENANCE JOB	ODOMETER READING (x 1000 Km)					ANNUAL
			1	6	12	18	24	CHECK
9	* Wheel bearings	• Check bearing for looseness or damage.		√	√	√	√	
10	* Steering bearings	• Check bearing play and steering for roughness. • Lubricate with lithium-soap-based grease.	√	√	√	√	√	
11	* Chassis fasteners	• Make sure that all nuts, bolts and screws are properly tightened.		√	√	√	√	√
12	Centerstand	• Check operation. • Lubricate.		√	√	√	√	√
13	* Front fork	• Check operation and for oil leakage.		√	√	√	√	
14	* Shock absorber assembly	• Check operation and shock absorber for oil leakage.		√	√	√	√	
15	* Carburetor	• Adjust engine idling speed.	√	√	√	√	√	√
16	* Autolube pump	• Check operation. • Bleed if necessary.	√		√		√	√
17	* Cooling system	• Check coolant level and vehicle for coolant leakage. • Change.		√	√	√	√	√
18	Final transmission oil	• Check vehicle for oil leakage. • Change.	√	√		√		
19	* V-belt	• Replace.						
20	* Front and rear brake switches	• Check operation.	√	√	√	√	√	√
21	Moving parts and cables	• Lubricate.		√	√	√	√	√
22	* Lights, signals and switches	• Check operation. • Adjust headlight beam.	√	√	√	√	√	√

PERIODIC MAINTENANCE AND MINOR REPAIR

EAU18660

NOTE:

- The air filter needs more frequent service if you are riding in unusually wet or dusty areas.
 - Hydraulic brake service
 - Regularly check and, if necessary, correct the brake fluid level.
 - Every two years replace the internal components of the brake master cylinder and caliper, and change the brake fluid.
 - Replace the brake hoses every four years and if cracked or damaged.
-

PERIODIC MAINTENANCE AND MINOR REPAIR

EAU19602

Checking the spark plug

The spark plug is an important engine component, which is easy to check. Since heat and deposits will cause any spark plug to slowly erode, the spark plug should be removed and checked in accordance with the periodic maintenance and lubrication chart. In addition, the condition of the spark plug can reveal the condition of the engine.

To remove the spark plug

1. Remove the spark plug cap.
2. Remove the spark plug as shown, with the spark plug wrench included in the owner's tool kit.

To check the spark plug

1. Check that the porcelain insulator around the center electrode of the spark plug is a medium-to-light tan (the ideal color when the vehicle is ridden normally).

NOTE:

If the spark plug shows a distinctly different color, the engine could be defective. Do not attempt to diagnose

such problems yourself. Instead, have a Yamaha dealer check the vehicle.

2. Check the spark plug for electrode erosion and excessive carbon or other deposits, and replace it if necessary.

Specified spark plug:
BR8HS/NGK

To install the spark plug

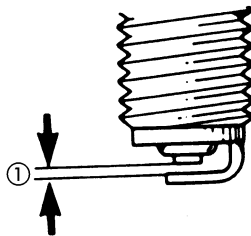

1. Distance between electrodes

1. Measure the spark plug gap with a wire thickness gauge and, if necessary, adjust the gap to specification.

Spark plug gap:
0,6 ~ 0,7 mm (0,24 ~ 0,27in)

2. Clean the surface of the spark plug gasket and its mating surface, and then wipe off any grime from the spark plug threads.
3. Install the spark plug with the spark plug wrench, and then tighten it to the specified torque.

Tightening torque:

Spark plug:
20 Nm (2,0 m•kgf, 14,6 ft•lbf)

NOTE:

If a torque wrench is not available when installing a spark plug, a good estimate of the correct torque is 1/4-1/2 turn past finger tight. However, the spark plug should be tightened to the specified torque as soon as possible.

4. Install the spark plug cap.

PERIODIC MAINTENANCE AND MINOR REPAIR

Final transmission oil

EAU20060

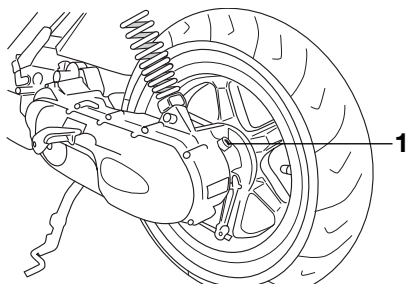

1. Oil filler bolt

The final transmission case must be checked for oil leakage before each ride. If any leakage is found, have a Yamaha dealer check and repair the scooter. In addition, the final transmission oil must be changed as follows at the intervals specified in the periodic maintenance and lubrication chart.

1. Start the engine, warm it up by riding the scooter for several minutes, and then stop the engine.

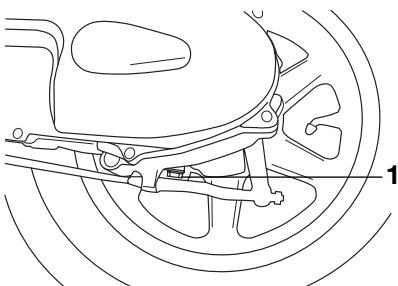

1. Drain plug

2. Place the scooter on the centers-stand.
3. Place an oil pan under the final transmission case to collect the used oil.
4. Remove the oil filler cap and drain bolt to drain the oil from the final transmission case.
5. Install the final transmission oil drain bolt, and then tighten it to the specified torque.

Tightening torque:

Final transmission oil drain bolt:
18 Nm (1,8 m•kgf, 13,2 ft•lbf)

6. Add the specified amount of the recommended final transmission

oil, and then install and tighten the oil filler cap.

Recommended final transmission oil:

SAE30 motor oil.

Oil quantity:

0,11 L (0,0003 Imp.qt)

EWA11310

⚠ WARNING

- Make sure that no foreign material enters the final transmission case.
- Make sure that no oil gets on the tire or wheel.

7. Check the final transmission case for oil leakage. If oil is leaking, check for the cause.

6

EAUS1200

Coolant (only for liquid-cooled models)

The coolant level should be checked before each ride. In addition, the coolant must be changed at the intervals specified in the periodic maintenance and lubrication chart.

PERIODIC MAINTENANCE AND MINOR REPAIR

EAUS1080

To check the coolant level

1. Place the vehicle on a level surface and hold it in an upright position.

NOTE:

- The coolant level must be checked on a cold engine since the level varies with engine temperature.
- Make sure that the vehicle is positioned straight up when checking the coolant level. A slight tilt to the side can result in a false reading.

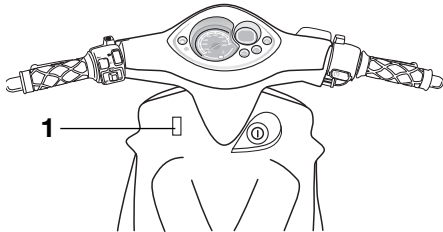

1. Coolant level gauge window

2. Check the coolant level through the check window.

NOTE:

The coolant should be between the minimum and maximum level marks.

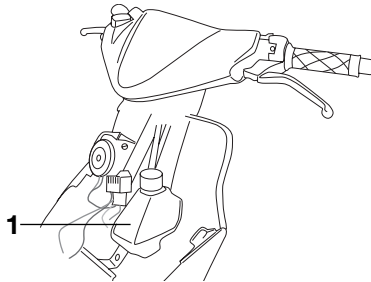

1. Coolant reservoir

3. If the coolant is at or below the minimum level mark, remove the front cowling by removing the screws.
4. Open the reservoir cap, and then add coolant to the maximum level mark.

Coolant reservoir capacity:
0,380 L (0,00103 Imp.qt)

ECA10470

CAUTION

- If coolant is not available, use distilled water or soft tap water instead. Do not use hard water or salt water since it is harmful to the engine.
 - If water has been used instead of coolant, replace it with coolant as soon as possible, otherwise the engine may not be sufficiently cooled and the cooling system will not be protected against frost and corrosion.
 - If water has been added to the coolant, have a Yamaha dealer check the antifreeze content of the coolant as soon as possible, otherwise the effectiveness of the coolant will be reduced.
5. Close the reservoir cap, and then install the front cowling by installing the screws.

PERIODIC MAINTENANCE AND MINOR REPAIR

EAUS1090

Cleaning the air filter element

The air filter element should be cleaned at the intervals specified in the periodic maintenance and lubrication chart. Clean the air filter element more frequently if you are riding in unusually wet or dusty areas.

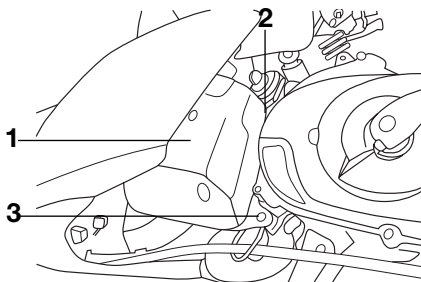

1. Lid from the air filter box
2. Screw
3. Screw

1. Remove the screw clamp and the screws that fasten the air filter case to the crankcase.

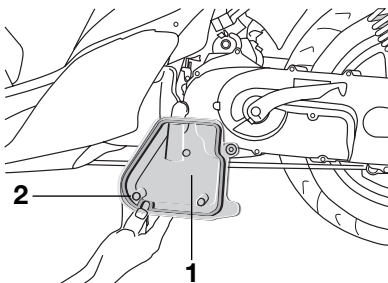

1. Lid from the air filter box
2. Screws (x 3)

2. Remove the air filter case cover by removing the screws.
3. Pull the air filter element out.
4. Clean the air filter element with solvent, and then squeeze the remaining solvent out.

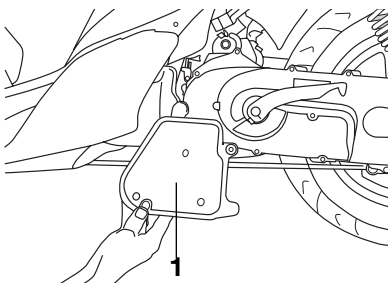

1. The air filter

EWA10430

⚠ WARNING

Use only a dedicated parts cleaning solvent. To avoid the risk of fire or explosion, do not use gasoline or solvents with a low flash point.

ECA10510

CAUTION

To avoid damaging the foam material, handle it gently and carefully, and do not twist or wring it.

5. Apply oil of the recommended type to the entire surface of the sponge material, and then squeeze the excess oil out.

NOTE:

The air filter element should be wet but not dripping.

Recommended oil:
Engine oil

6. Insert the element into the air filter case.

PERIODIC MAINTENANCE AND MINOR REPAIR

ECA10480

CAUTION

- Make sure that the air filter element is properly seated in the air filter case.
- The engine should never be operated without the air filter element installed, otherwise the piston(s) and/or cylinder(s) may become excessively worn.

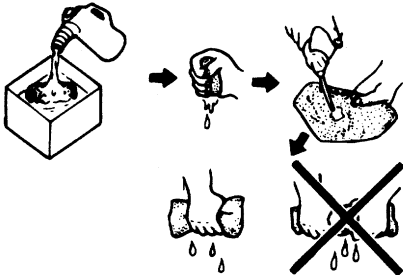

7. Install the air filter case cover by installing the screws.
8. Install the screw clamp and the screws that fasten the air filter case to the crankcase.

EAU21300

Adjusting the carburetor

The carburetor is an important part of the engine and requires very sophisticated adjustment. Therefore, all carburetor adjustments should be left to a Yamaha dealer, who has the necessary professional knowledge and experience.

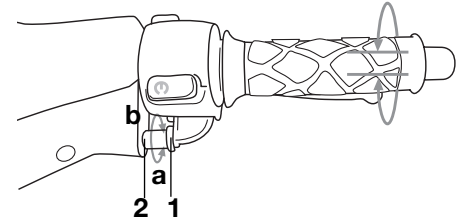

1. Locknut
2. Adjuster
3. Free play

EAU21370

Adjusting the throttle cable free play

The throttle cable free play should measure 2 ~ 5 mm (0,8 ~ 0,20 in) at the throttle grip. Periodically check the throttle cable free play and, if necessary, adjust it as follows.

NOTE:

The engine idling speed must be correctly adjusted before checking and adjusting the throttle cable free play.

1. Loosen the locknut.
2. To increase the throttle cable free play, turn the adjusting nut in direction (a). To decrease the throttle cable free play, turn the adjusting nut in direction (b).
3. Tighten the locknut.

EAU33600

Tires

To maximize the performance, durability, and safe operation of your vehicle, note the following points regarding the specified tires.

Tire air pressure

The tire air pressure should be checked and, if necessary, adjusted before each ride.

PERIODIC MAINTENANCE AND MINOR REPAIR

EWA10500

EWA11200

⚠ WARNING

- The tire air pressure must be checked and adjusted on cold tires (i.e., when the temperature of the tires equals the ambient temperature).
- The tire air pressure must be adjusted in accordance with the riding speed and with the total weight of rider, passenger, cargo, and accessories approved for this model.

Tire air pressure (measured on cold tires):

0~90 kg (0~198 lb):

Front:

175 kPa (24,90lb) (1,75 kgf/cm²)

Rear:

200 kPa (28,44lb) (2,0 kgf/cm²)

90~190 kg (198~419 lb) to maximum load:

Front:

175 kPa (24,90lb) (1,75 kgf/cm²)

Rear:

225 kPa (32lb) (2,25 kgf/cm²)

Maximum load*:

158,3 kg (348,4lb) CS50Z

161kg (255lb) CS50

* Total weight of rider, passenger, cargo and accessories

⚠ WARNING

Because loading has an enormous impact on the handling, braking, performance and safety characteristics of your vehicle, you should keep the following precautions in mind.

- **NEVER OVERLOAD THE VEHICLE!** Operation of an overloaded motorcycle may result in tire damage, loss of control, or severe injury. Make sure that the total weight of rider, passenger, cargo, and accessories does not exceed the specified maximum load for the vehicle.
- Do not carry along loosely packed items, which can shift during a ride.
- Securely pack the heaviest items close to the center of the vehicle and distribute the weight evenly on both sides.
- Adjust the tire air pressure with regard to the load.
- Check the tire condition and air pressure before each ride.

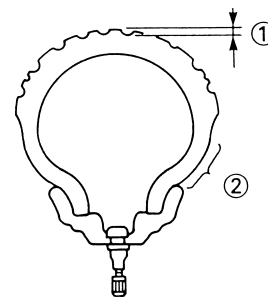

1. Depth
2. Side face

Tire inspection

The tires must be checked before each ride. If the center tread depth reaches the specified limit, if the tire has a nail or glass fragments in it, or if the sidewall is cracked, have a Yamaha dealer replace the tire immediately.

Minimum tire tread depth (front and rear):

1.6 mm (0.06 in)

PERIODIC MAINTENANCE AND MINOR REPAIR

NOTE:

The tire tread depth limits may differ from country to country. Always comply with the local regulations.

Tire information

This model is equipped with tubeless tires.

Front tire:

Size:
110/70-12

Rear tire:

Size:
120/70-12 (Spain)
130/70-12

ding the tires, should be left to a Yamaha dealer, who has the necessary professional knowledge and experience.

the motorcycle until the brake system has been checked or repaired by a Yamaha dealer.

EAU22170

Adjusting the rear brake lever free play

EAU22100

Adjusting the brake lever free play

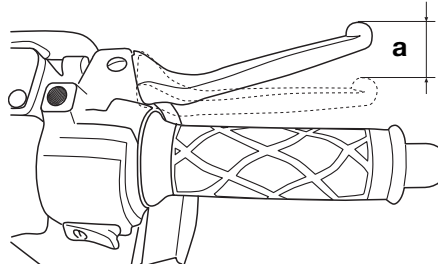

a. Free play

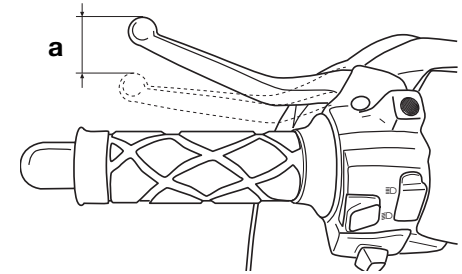

a. Free play

The brake lever free play should measure 2 ~ 5 mm (0,08 ~ 0,20 in) as shown. Periodically check the brake lever free play and, if necessary, have a Yamaha dealer adjust it.

EWA10640

The brake lever free play should measure 5 ~ 10 mm (0,2 ~ 0,4 in) as shown. Periodically check the brake lever free play and, if necessary, adjust it as follows.

⚠ WARNING

- Have a Yamaha dealer replace excessively worn tires. Besides being illegal, operating the vehicle with excessively worn tires decreases riding stability and can lead to loss of control.
- The replacement of all wheel and brake related parts, inclu-

⚠ WARNING

An incorrect brake lever free play indicates a hazardous condition in the brake system. Do not operate

PERIODIC MAINTENANCE AND MINOR REPAIR

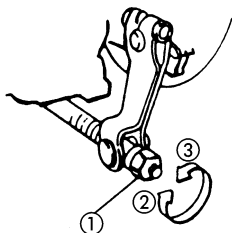

1. Adjuster
2. To decrease free play
3. To increase free play

To increase the brake lever free play, turn the adjusting nut at the brake shoe plate in direction (2). To decrease the brake lever free play, turn the adjusting nut in direction (3).

EWA10650

⚠ WARNING

If proper adjustment cannot be obtained as described, have a Yamaha dealer make this adjustment.

EAU22380

Checking the front brake pads and rear brake shoes

The front brake pads and the rear brake shoes must be checked for wear at the intervals specified in the periodic maintenance and lubrication chart.

EAU22430

Front brake pads

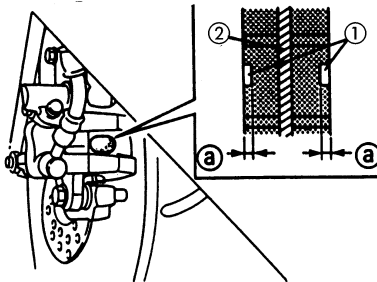

1. Wear indicator
 2. Front brake disc
- (a). Wearing limit: 0,8 mm.

Each front brake pad is provided with wear indicator grooves, which allow you to check the brake pad wear without having to disassemble the brake. To check the brake pad wear, check the wear indicator grooves. If a brake

pad has worn to the point that the wear indicator grooves have almost disappeared, have a Yamaha dealer replace the brake pads as a set.

EAU22540

Rear brake shoes

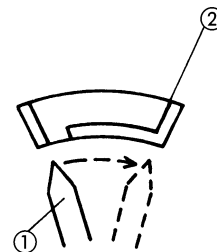

1. Wear indicator
2. Limit of wear

The rear brake is provided with a wear indicator, which allows you to check the brake shoe wear without having to disassemble the brake. To check the brake shoe wear, check the position of the wear indicator while applying the brake. If a brake shoe has worn to the point that the wear indicator reaches the wear limit line, have a Yamaha dealer replace the brake shoes as a set.

PERIODIC MAINTENANCE AND MINOR REPAIR

Checking the front brake fluid level

EAU32343

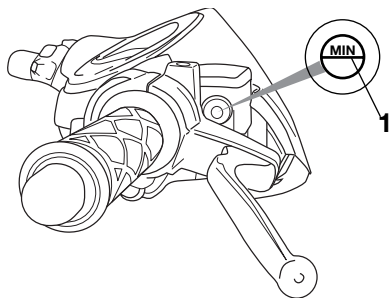

1. Minimum level

6

Insufficient brake fluid may allow air to enter the brake system, possibly causing it to become ineffective. Before riding, check that the brake fluid is above the minimum level mark and replenish if necessary. A low brake fluid level may indicate worn brake pads and/or brake system leakage. If the brake fluid level is low, be sure to check the brake pads for wear and the brake system for leakage.

Observe these precautions:

- When checking the fluid level, make sure that the top of the master cylinder is level by turning the handlebars.
- Use only the recommended quality brake fluid, otherwise the rubber seals may deteriorate, causing leakage and poor braking performance.

Recommended brake fluid:
DOT 4

- Refill with the same type of brake fluid. Mixing fluids may result in a harmful chemical reaction and lead to poor braking performance.
- Be careful that water does not enter the master cylinder when refilling. Water will significantly lower the boiling point of the fluid and may result in vapor lock.
- Brake fluid may deteriorate painted surfaces or plastic parts. Always clean up spilled fluid immediately.

- As the brake pads wear, it is normal for the brake fluid level to gradually go down. However, if the brake fluid level goes down suddenly, have a Yamaha dealer check the cause.

EAU23720

Changing the brake fluid

Have a Yamaha dealer change the brake fluid at the intervals specified in the NOTE after the periodic maintenance and lubrication chart. In addition, have the oil seals of the brake master cylinder and caliper as well as the brake hose replaced at the intervals listed below or whenever they are damaged or leaking.

- Oil seals: Replace every two years.
- Brake hose: Replace every four years.

EAU23100

Checking and lubricating the cables

The operation of all control cables and the condition of the cables should be checked before each ride,

PERIODIC MAINTENANCE AND MINOR REPAIR

and the cables and cable ends should be lubricated if necessary. If a cable is damaged or does not move smoothly, have a Yamaha dealer check or replace it.

Recommended lubricant:
Engine oil

EWA10720

⚠ WARNING

Damage to the outer sheath may interfere with proper cable operation and will cause the inner cable to rust. Replace a damaged cable as soon as possible to prevent unsafe conditions.

EAU23110

Checking and lubricating the throttle grip and cable

The operation of the throttle grip should be checked before each ride. In addition, the cable should be lubricated or replaced at the intervals specified in the periodic maintenance chart.

Recommended lubricant:

Lithium-soap-based grease (all-purpose grease)

EAU23120

Adjusting the Autolube pump

The Autolube pump is a vital and sophisticated component of the engine, which must be adjusted by a Yamaha dealer at the intervals specified in the periodic maintenance and lubrication chart.

EAU23170

Lubricating the front and rear brake levers



The pivoting points of the front and rear brake levers must be lubricated at the intervals specified in the periodic maintenance and lubrication chart.

EAU23190

Checking and lubricating the centerstand

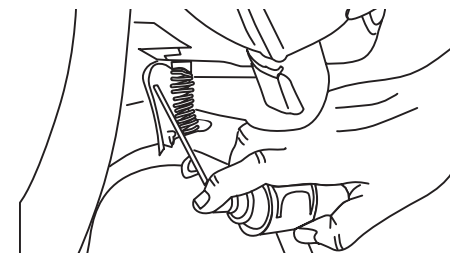

The operation of the centerstand should be checked before each ride, and the pivots and metal-to-metal contact surfaces should be lubricated if necessary.

EAU11300

⚠ WARNING

If the centerstand does not move up and down smoothly, have a Yamaha dealer check or repair it.

Recommended lubricant:

Lithium-soap-based grease (all-purpose grease)

PERIODIC MAINTENANCE AND MINOR REPAIR

Checking the front fork

EAU23271

The condition and operation of the front fork must be checked as follows at the intervals specified in the periodic maintenance and lubrication chart.

To check the condition

EWA10750

⚠ WARNING

Securely support the motorcycle so that there is no danger of it falling over.

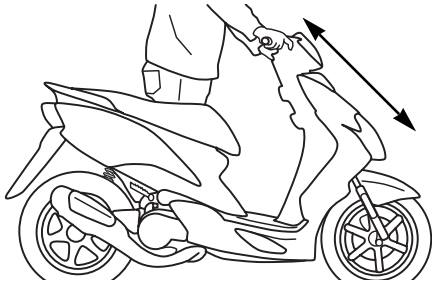

Check the inner tubes for scratches, damage and excessive oil leakage.

To check the operation

1. Place the motorcycle on a level surface and hold it in an upright position.

2. While applying the front brake, push down hard on the handlebars several times to check if the front fork compresses and rebounds smoothly.

ECA10590

CAUTION

If any damage is found or the front fork does not operate smoothly, have a Yamaha dealer check or repair it.

EAU23280

Checking the steering

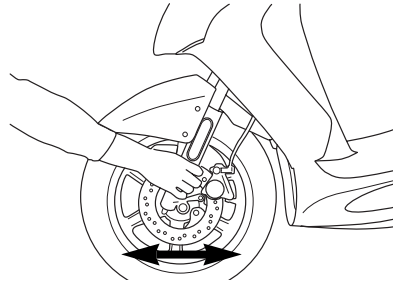

Worn or loose steering bearings may cause danger. Therefore, the operation of the steering must be checked as follows at the intervals specified in the periodic maintenance and lubrication chart.

1. Place a stand under the engine to raise the front wheel off the ground.

EWA10750

⚠ WARNING

Securely support the motorcycle so that there is no danger of it falling over.

2. Hold the lower ends of the front fork legs and try to move them forward and backward. If any free play can be felt, have a Yamaha dealer check or repair the steering.

EAU23290

Checking the wheel bearings

The front and rear wheel bearings must be checked at the intervals specified in the periodic maintenance and lubrication chart. If there is play in the wheel hub or if the wheel does not turn smoothly, have a Yamaha dealer check the wheel bearings.

PERIODIC MAINTENANCE AND MINOR REPAIR

Replacing the headlight bulb or a front turn signal light bulb

EAUS1110

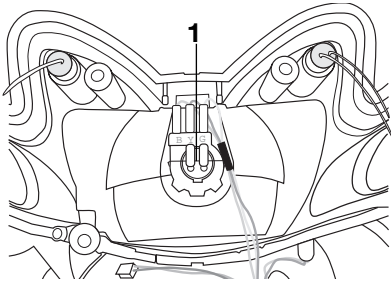

1. Headlight bulb

If a bulb burns out, replace it as follows.

ECA10670

CAUTION

It is advisable to have a Yamaha dealer perform this job.

Headlight bulb

1. Remove the front panel by removing the screws.

WARNING

Headlight bulbs get very hot. Therefore, keep flammable products away from a lit headlight bulb, and do not touch the bulb until it has cooled down.

2. Remove the defective bulb from the socket.
3. Insert a new bulb into the socket.
4. Install the panel by installing the screws.
5. Have a Yamaha dealer adjust the headlight beam if necessary.

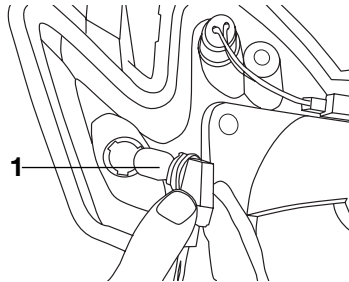

Front turn signal light bulb

1. Remove the front panel by removing the screws.
2. Remove the defective bulb from the socket.

EWA10790

3. Insert a new bulb into the socket.
4. Install the panel by installing the screws.

EAU24281

Replacing a turn signal light bulb or the tail/brake light bulb

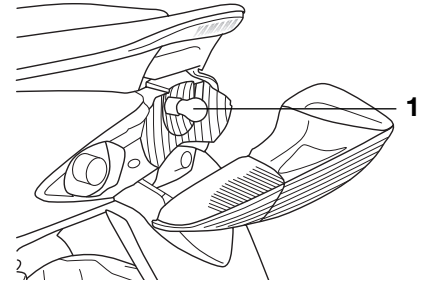

1. Tail light bulb

1. Remove the lens by removing the screws.
2. Remove the defective bulb by pushing it in and turning it counterclockwise.
3. Insert a new bulb into the socket, push it in, and then turn it clockwise until it stops.

PERIODIC MAINTENANCE AND MINOR REPAIR

EAU24310

EAU23370

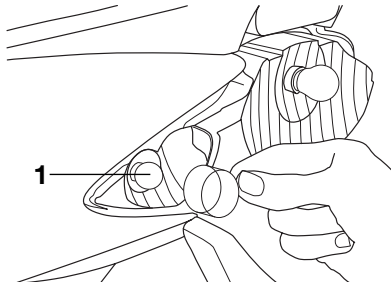

1. Rear turn signal light bulb

4. Install the lens by installing the screws.

ECA10680

CAUTION

6

Do not overtighten the screws, otherwise the lens may break.

Replacing the license plate light bulb



1. License plate light

1. Remove the license plate light unit by removing the screws.
2. Remove the socket (together with the bulb) by pulling it out.
3. Remove the defective bulb by pulling it out.
4. Insert a new bulb into the socket.
5. Install the socket (together with the bulb) by pushing it in.
6. Install the license plate light unit by installing the screws.

Battery

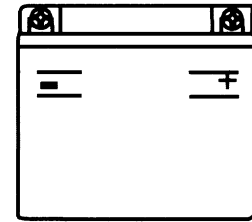

This model is equipped with a sealed-type (MF) battery, which does not require any maintenance. There is no need to check the electrolyte or to add distilled water.

ECA10620

CAUTION

Never attempt to remove the battery cell seals, as this would permanently damage the battery.

EWA10760

WARNING

- **Electrolyte is poisonous and dangerous since it contains sulfuric acid, which causes severe burns. Avoid any contact with skin, eyes or clothing and always shield your eyes**

PERIODIC MAINTENANCE AND MINOR REPAIR

when working near batteries. In case of contact, administer the following **FIRST AID**.

- **EXTERNAL:** Flush with plenty of water.
- **INTERNAL:** Drink large quantities of water or milk and immediately call a physician.
- **EYES:** Flush with water for 15 minutes and seek prompt medical attention.
- Batteries produce explosive hydrogen gas. Therefore, keep sparks, flames, cigarettes, etc., away from the battery and provide sufficient ventilation when charging it in an enclosed space.
- **KEEP THIS AND ALL BATTERIES OUT OF THE REACH OF CHILDREN.**

To charge the battery

Have a Yamaha dealer charge the battery as soon as possible if it seems to have discharged. Keep in mind that the battery tends to discharge more quickly if the vehicle is equipped with optional electrical accessories.

To store the battery

1. If the vehicle will not be used for more than one month, remove the battery, fully charge it, and then place it in a cool, dry place.
2. If the battery will be stored for more than two months, check it at least once a month and fully charge it if necessary.
3. Fully charge the battery before installation.
4. After installation, make sure that the battery leads are properly connected to the battery terminals.

- To charge a sealed-type (MF) battery, a special (constant-voltage) battery charger is required. Using a conventional battery charger will damage the battery. If you do not have access to a sealed-type (MF) battery charger, have a Yamaha dealer charge your battery.

EAUS1180

Replacing the fuse

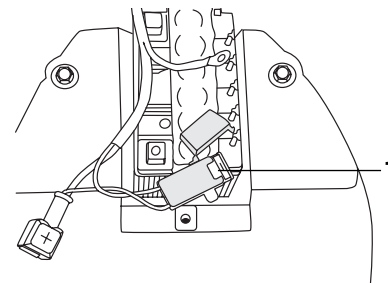

1. Fuse

The fuse holder is located beside the battery case.

If the fuse is blown, replace it as follows.

1. Turn the key to "OFF" and turn off all electrical circuits.

CAUTION

- Always keep the battery charged. Storing a discharged battery can cause permanent battery damage.

ECA10630

PERIODIC MAINTENANCE AND MINOR REPAIR

2. Remove the blown fuse, and then install a new fuse of the specified amperage.

Specified fuse:
7,5 A x 1

ECA10640

CAUTION

Do not use a fuse of a higher amperage rating than recommended to avoid causing extensive damage to the electrical system and possibly a fire.

3. Turn the key to "ON" and turn on the electrical circuits to check if the devices operate.
4. If the fuse immediately blows again, have a Yamaha dealer check the electrical system.

EAU25860

Troubleshooting

Although Yamaha scooters receive a thorough inspection before shipment from the factory, trouble may occur during operation. Any problem in the fuel, compression, or ignition systems, for example, can cause poor starting and loss of power.

The following troubleshooting chart represents a quick and easy procedure for checking these vital systems yourself. However, should your scooter require any repair, take it to a Yamaha dealer, whose skilled technicians have the necessary tools, experience, and know-how to service the scooter properly.

Use only genuine Yamaha replacement parts. Imitation parts may look like Yamaha parts, but they are often inferior, have a shorter service life and can lead to expensive repair bills.

PERIODIC MAINTENANCE AND MINOR REPAIR

EAU25901

Troubleshooting chart

EWA10840

⚠ WARNING

Keep away from open flames and do not smoke while checking or working on the fuel system.

1. Fuel

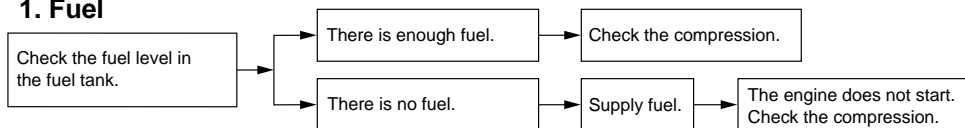

2. Compression

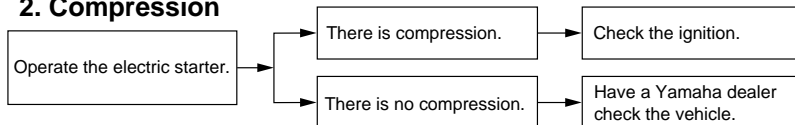

3. Ignition

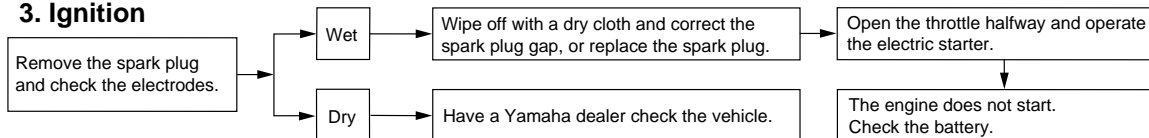

4. Battery

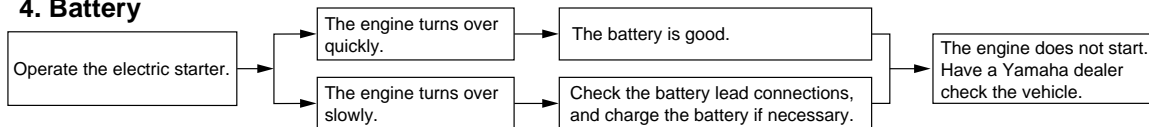

SCOOTER CARE AND STORAGE

EAU26090

Care

While the open design of a scooter reveals the attractiveness of the technology, it also makes it more vulnerable. Rust and corrosion can develop even if high-quality components are used. A rusty exhaust pipe may go unnoticed on a car, however, it detracts from the overall appearance of a scooter. Frequent and proper care does not only comply with the terms of the warranty, but it will also keep your scooter looking good, extend its life and optimize its performance.

Before cleaning

1. Cover the muffler outlet with a plastic bag after the engine has cooled down.
2. Make sure that all caps and covers as well as all electrical couplers and connectors, including the spark plug cap, are tightly installed.
3. Remove extremely stubborn dirt, like oil burnt onto the crankcase, with a degreasing agent and a brush, but never apply such pro-

ducts onto seals, gaskets and wheel axles. Always rinse the dirt and degreaser off with water.

Cleaning

ECA10780

CAUTION

- **Avoid using strong acidic wheel cleaners, especially on spoked wheels. If such products are used on hard-to-remove dirt, do not leave the cleaner on the affected area any longer than instructed. Also, thoroughly rinse the area off with water, immediately dry it, and then apply a corrosion protection spray.**
- **Improper cleaning can damage windshields, cowlings, panels and other plastic parts. Use only a soft, clean cloth or sponge with mild detergent and water to clean plastic.**
- **Do not use any harsh chemical products on plastic parts. Be sure to avoid using cloths or sponges which have been in contact with strong or abrasive cleaning products, solvent or**

thinner, fuel (gasoline), rust removers or inhibitors, brake fluid, antifreeze or electrolyte.

- **Do not use high-pressure washers or steam-jet cleaners since they cause water seepage and deterioration in the following areas: seals (of wheel and swingarm bearings, fork and brakes), electric components (couplers, connectors, instruments, switches and lights), breather hoses and vents.**
 - **For scooters equipped with a windshield: Do not use strong cleaners or hard sponges as they will cause dulling or scratching. Some cleaning compounds for plastic may leave scratches on the windshield. Test the product on a small hidden part of the windshield to make sure that it does not leave any marks. If the windshield is scratched, use a quality plastic polishing compound after washing.**
-

SCOOTER CARE AND STORAGE

After normal use

Remove dirt with warm water, a mild detergent, and a soft, clean sponge, and then rinse thoroughly with clean water. Use a toothbrush or bottle-brush for hard-to-reach areas. Stubborn dirt and insects will come off more easily if the area is covered with a wet cloth for a few minutes before cleaning.

After riding in the rain, near the sea or on salt-sprayed roads

Since sea salt or salt sprayed on the roads during winter are extremely corrosive in combination with water, carry out the following steps after each ride in the rain, near the sea or on salt-sprayed roads.

NOTE:

Salt sprayed on roads in the winter may remain well into spring.

1. Clean the scooter with cold water and a mild detergent after the engine has cooled down.

ECA10790

CAUTION

Do not use warm water since it increases the corrosive action of the salt.

2. Apply a corrosion protection spray on all metal, including chrome- and nickel-plated, surfaces to prevent corrosion.

After cleaning

1. Dry the scooter with a chamois or an absorbing cloth.
2. Use a chrome polish to shine chrome, aluminum and stainless-steel parts, including the exhaust system. (Even the thermally induced discoloring of stainless-steel exhaust systems can be removed through polishing.)
3. To prevent corrosion, it is recommended to apply a corrosion protection spray on all metal, including chrome- and nickel-plated, surfaces.
4. Use spray oil as a universal cleaner to remove any remaining dirt.
5. Touch up minor paint damage caused by stones, etc.

6. Wax all painted surfaces.
7. Let the scooter dry completely before storing or covering it.

EWA10940

⚠ WARNING

- **Make sure that there is no oil or wax on the brakes or tires. If necessary, clean the brake discs and brake linings with a regular brake disc cleaner or acetone, and wash the tires with warm water and a mild detergent.**
- **Before operating the scooter test its braking performance and cornering behavior.**

ECA10800

CAUTION

- **Apply spray oil and wax sparingly and make sure to wipe off any excess.**
- **Never apply oil or wax to any rubber and plastic parts, but treat them with a suitable care product.**
- **Avoid using abrasive polishing compounds as they will wear away the paint.**

SCOOTER CARE AND STORAGE

NOTE:

Consult a Yamaha dealer for advice on what products to use.

EAU26300

Storage Short-term

Always store your scooter in a cool, dry place and, if necessary, protect it against dust with a porous cover.

ECA10820

CAUTION

- **Storing the scooter in a poorly ventilated room or covering it with a tarp, while it is still wet, will allow water and humidity to seep in and cause rust.**
- **To prevent corrosion, avoid damp cellars, stables (because of the presence of ammonia) and areas where strong chemicals are stored.**

Long-term

Before storing your scooter for several months:

1. Follow all the instructions in the “Care” section of this chapter.
2. Drain the carburetor float cham-

ber by loosening the drain bolt; this will prevent fuel deposits from building up. Pour the drained fuel into the fuel tank.

3. Fill up the fuel tank and add fuel stabilizer (if available) to prevent the fuel tank from rusting and the fuel from deteriorating.
4. Perform the following steps to protect the cylinder, piston rings, etc. from corrosion.
 - a. Remove the spark plug cap and spark plug.
 - b. Pour a teaspoonful of engine oil into the spark plug bore.
 - c. Install the spark plug cap onto the spark plug, and then place the spark plug on the cylinder head so that the electrodes are grounded. (This will limit sparking during the next step.)
 - d. Turn the engine over several times with the starter. (This will coat the cylinder wall with oil.)
 - e. Remove the spark plug cap from the spark plug, and then install the spark plug and the spark plug cap.

WARNING

EWA10950

To prevent damage or injury from sparking, make sure to ground the spark plug electrodes while turning the engine over.

5. Lubricate all control cables and the pivoting points of all levers and pedals as well as of the sidestand/centerstand.
6. Check and, if necessary, correct the tire air pressure, and then lift the scooter so that both of its wheels are off the ground. Alternatively, turn the wheels a little every month in order to prevent the tires from becoming degraded in one spot.
7. Cover the muffler outlet with a plastic bag to prevent moisture from entering it.
8. Remove the battery and fully charge it. Store it in a cool, dry place and charge it once a month. Do not store the battery in an excessively cold or warm place [less than 0 °C (30 °F) or more than 30 °C (90 °F)]. For more

SCOOTER CARE AND STORAGE

information on storing the battery, see page 6-17.

NOTE: _____
Make any necessary repairs before storing the scooter.

SPECIFICATIONS

Dimensions

Overall length
1740 mm
Overall width
675 mm
Overall height
1065 mm
Seat height
770 mm
Wheelbase
1210 mm
Ground clearance
132 mm

Weight

With oil and fuel
CS50 80.5 kg
CS50Z 83.7 kg

Engine

Engine type
CS50 Air cooled 2-stroke
CS50Z Liquid cooled 2-stroke
Cylinder arrangement
Forward-inclined single cylinder
Displacement
49.2 cm³
Bore x stroke
40.0 x 39.2 mm
Compression ratio
CS50 10.20 :1
CS50Z 11.40 :1
Starting system
Electric starter and kickstarter
Lubrication system
Separate lubrication (Yamaha autolube)

Type
YAMALUBE 2-cycle oil or 2-stroke engine oil

Engine oil quantity

Quantity
1.4 L

Transmission oil

Type
YAMALUBE 4 (10W30) or SAE10W30 type SE motor oil
Oil change quantity
0.10 L
Air filter element
Wet element

Fuel

Recommended fuel
Regular unleaded gasoline
Fuel tank capacity
5.5 L

Carburetor

Manufacturer
CS50 DELLORTO GURTNER
CS50Z DELLORTO
Type x quantity
CS50 PHVA 12 ZS/1 PY 12/1
CS50Z PHVA 12 ZS/1

Spark plug(s)

Manufacturer/model
NGK/BR8HS
Spark plug gap
0.6-0.7 mm
Clutch type
Dry, centrifugal automatic

Transmission

Primary reduction system
Helical gear
Primary reduction ratio
52/13 (4.000)
Secondary reduction system
Spur gear
Secondary reduction ratio
CS50 42/13 (3.230)
CS50Z 43 x 13 (3.310)
Transmission type
Single speed automatic
Operation
Centrifugal automatic type

Chassis

Caster angle
25.00 degree
Trail
80.0 mm

Front tire

Size
110/70-12 47L

Rear tire

Size
120/70-12 51L 130/70-12 56L
Maximum load
CS50 161 kg
CS50Z 158 kg

Tire air pressure (measured on cold tires)

Front
175 kPa
Rear
200 kPa

SPECIFICATIONS

Front wheel

Rim size
MT 2.75X12

Rear wheel

Rim size
MT 3.00X12

Front brake

Type
Single disc brake
Operation
Right hand operation
Recommended fluid
DOT 4

Rear brake

Type
Drum brake
Operation
Left hand operation

Front suspension

Type
Telescopic fork
Spring/shock absorber type
Coil spring/oil damper
Wheel travel
70.0 mm

Rear suspension

Type
Unit swing
Spring/shock absorber type
Coil spring/oil damper
Wheel travel
60.0 mm

Electrical system

Ignition system

CDI
Charging system
Flywheel magneto

Battery

Model
GT4L-BS
Voltage, capacity
12 V, 4.0 Ah

Bulb voltage, wattage x quantity

Headlight
12 V, 35 W/35.0 W x 1
Tail/brake light
12 V, 21.0 W/5.0 W x 1
Front turn signal light
12 V, 16.0 W x 2
Rear turn signal light
12 V, 10.0 W x 2
Meter lighting
12 V, 1.2 W x 2
Oil level warning light
LED
Fuel level warning light
NONE

Fuses

Main fuse
7.5 A
Engine idle speed
1800-2200 r/min
Brake pad lining thickness-inner
4.0 mm
Limit
0.8 mm
Brake pad lining thickness-outer
4.0 mm

Limit
0.8 mm
Front brake lever free play
2.0-5.0 mm
Rear brake lever free play
10.0-20.0 mm

CONSUMER INFORMATION

EAU26351

Identification numbers

Record the key identification number, vehicle identification number and model label information in the spaces provided below for assistance when ordering spare parts from a Yamaha dealer or for reference in case the vehicle is stolen.

KEY IDENTIFICATION NUMBER:

VEHICLE IDENTIFICATION NUMBER:

MODEL LABEL INFORMATION:

9

Key identification number

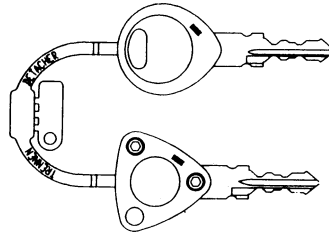

The key identification number is stamped into the key tag. Record this number in the space provided and use it for reference when ordering a new key.

EAU26381

The vehicle identification number is stamped into the frame.

NOTE:

The vehicle identification number is used to identify your motorcycle and may be used to register your motorcycle with the licensing authority in your area.

EAU26540

Model label

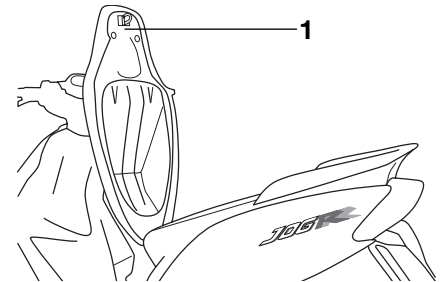

1. Model label

Vehicle identification number

EAU26410

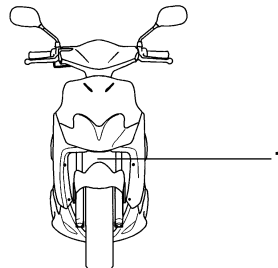

1. Vehicle identification number

The model label is affixed to the frame under the seat. (See page 3-6.) Record the information on this label in the space provided. This information will be needed when ordering spare parts from a Yamaha dealer.

2	2-Stroke engine oil.....1-1	Front brake lever.....6-1	Storage compartment.....6-20
A	Acceleration and deceleration2-1	Fuel and 2 stroke engine oil tank caps.....6-2	Storage compartment.....7-1
	Adjusting the autolube pump2-1	Fuel gauge6-5	T
	Adjusting the carburetor2-2	H	Tires7-1
	Adjusting the front brake lever free play....2-3	Handlebar switches6-6	To check the coolant level7-3
	Adjusting the rear brake lever free play.....3-1	I	Troubleshooting8-1
	Adjusting the throttle cable free play.....3-1	Indicator lights6-6	Troubleshooting chart9-1
B	Battery.....3-1	K	
	Braking.....3-2	Kickstarter.....6-8	
C	Care.....3-3	L	
	Changing the brake fluid.....3-3	Left view.....6-9	
	Checking and lubricating the cables3-3	Lubricating the front and rear brake levers6-9	
	Checking and lubricating the centerstand.3-4	M	
	Checking and lubricating the throttle grip and cable.....3-4	Main switch/steering lock6-9	
	Checking the front brake fluid level.....3-4	P	
	Checking the front fork.....3-5	Parking.....6-11	
	Checking the spark plug.....3-6	Periodic maintenance and lubrication chart.....6-12	
	Checking the steering.....3-6	Pre-operation check list.....6-13	
	Checking the wheel bearings3-6	R	
	Checking the front brake pads and rear brake shoes.....4-1	Rear brake lever.....6-14	
	Cleaning the air filter element4-2	Replacing a turn signal light bulb or the tail/brake light bulb.....6-14	
	Clock.....5-1	Replacing the fuse6-14	
	Controls and instruments5-1	Replacing the headlight bulb or a front turn signal light bulb6-14	
	Coolant (only for liquid-cooled models) ...5-2	Replacing the license plate light bulb.....6-15	
E	Engine break-in.....5-2	Right view6-15	
F	Final transmission oil5-2	S	
		Seat.....6-16	
		Speedometer unit6-17	
		Starting a cold engine.....6-18	
		Starting off6-19	



PRINTED IN SPAIN
2005.1-Bengar Gràfiques, S.L.
(E)