



**OWNER'S MANUAL**

**FZ6-S**  
**FZ6-SS**

**5VX-28199-EB**

## DECLARATION of CONFORMITY

We

**Company: MORIC CO.,LTD.**

**Address: 1450-6 Mori Mori-Machi Shuchi-gun Shizuoka 437-0292 Japan**

Hereby declare that the product:

**Kind of equipment: IMMOBILIZER**

**Type-designation: 5SL-00**

is in compliance with following norm(s) or documents:

**R&TTE Directive(1999/5/EC)**

**EN300 330-2 v1.1.1(2001-6),EN60950(2000)**

**Two or Three-Wheel Motor Vehicles Directive(97/24/EC:Chapter 8,EMC)**

**Place of issue: Shizuoka,Japan**

**Date of issue: 1 Aug. 2002**

### Revolution record

No.	Contents	Date
1	To change contact person and integrate type-designation.	9 Jun. 2005

General manager of quality assurance div.

*9 Jun / 2005*

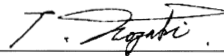

representative name and signature

MORIC CO., LTD.

1450-6 Mori-machi Shuchi-gun Shizuoka 437-0292 JAPAN Telephone +81-538-85-0757 Facsimile +81-538-85-0456

URL:<http://www.moric-jp.com>

Welcome to the Yamaha world of motorcycling!

As the owner of the FZ6-S/FZ6-SS, you are benefiting from Yamaha's vast experience and newest technology regarding the design and manufacture of high-quality products, which have earned Yamaha a reputation for dependability.

Please take the time to read this manual thoroughly, so as to enjoy all advantages of your FZ6-S/FZ6-SS. The owner's manual does not only instruct you in how to operate, inspect and maintain your motorcycle, but also in how to safeguard yourself and others from trouble and injury.

In addition, the many tips given in this manual will help keep your motorcycle in the best possible condition. If you have any further questions, do not hesitate to contact your Yamaha dealer.

The Yamaha team wishes you many safe and pleasant rides. So, remember to put safety first!

# IMPORTANT MANUAL INFORMATION

---

EAU10151

Particularly important information is distinguished in this manual by the following notations:

	<b>The Safety Alert Symbol means ATTENTION! BECOME ALERT! YOUR SAFETY IS INVOLVED!</b>
	<b>Failure to follow WARNING instructions could result in severe injury or death to the motorcycle operator, a bystander, or a person inspecting or repairing the motorcycle.</b>
<b>CAUTION:</b>	<b>A CAUTION indicates special precautions that must be taken to avoid damage to the motorcycle.</b>
<b>NOTE:</b>	A NOTE provides key information to make procedures easier or clearer.

## NOTE:

- This manual should be considered a permanent part of this motorcycle and should remain with it even if the motorcycle is subsequently sold.
- Yamaha continually seeks advancements in product design and quality. Therefore, while this manual contains the most current product information available at the time of printing, there may be minor discrepancies between your motorcycle and this manual. If you have any questions concerning this manual, please consult your Yamaha dealer.

EWA10030

## **WARNING**

---

**PLEASE READ THIS MANUAL CAREFULLY AND COMPLETELY BEFORE OPERATING THIS MOTORCYCLE.**

---

\*Product and specifications are subject to change without notice.

# **IMPORTANT MANUAL INFORMATION**

---

---

EAU10200

**FZ6-S/FZ6-SS  
OWNER'S MANUAL  
©2005 by Yamaha Motor Co., Ltd.  
1st edition, July 2005  
All rights reserved.  
Any reprinting or unauthorized use  
without the written permission of  
Yamaha Motor Co., Ltd.  
is expressly prohibited.  
Printed in Japan.**

# TABLE OF CONTENTS

---

<b>SAFETY INFORMATION</b> .....	1-1	<b>PRE-OPERATION CHECKS</b> .....	4-1	Adjusting the rear brake light switch .....	6-18
<b>DESCRIPTION</b> .....	2-1	Pre-operation check list .....	4-2	Checking the front and rear brake pads .....	6-18
Left view .....	2-1	<b>OPERATION AND IMPORTANT</b>		Checking the brake fluid level .....	6-19
Right view .....	2-2	<b>RIDING POINTS</b> .....	5-1	Changing the brake fluid .....	6-20
Controls and instruments .....	2-3	Starting the engine .....	5-1	Drive chain slack .....	6-20
<b>INSTRUMENT AND CONTROL</b>		Shifting .....	5-2	Cleaning and lubricating the drive chain .....	6-22
<b>FUNCTIONS</b> .....	3-1	Tips for reducing fuel consumption .....	5-3	Checking and lubricating the cables .....	6-22
Immobilizer system .....	3-1	Engine break-in .....	5-3	Checking and lubricating the throttle grip and cable .....	6-23
Main switch/steering lock .....	3-2	Parking .....	5-4	Checking and lubricating the brake and shift pedals .....	6-23
Indicator and warning lights .....	3-3	<b>PERIODIC MAINTENANCE AND</b>		Checking and lubricating the brake and clutch levers .....	6-24
LCD tachometer .....	3-5	<b>MINOR REPAIR</b> .....	6-1	Checking and lubricating the centerstand and sidestand .....	6-24
Multi-function display .....	3-5	Owner's tool kit .....	6-1	Lubricating the swingarm pivots .....	6-25
Anti-theft alarm (optional) .....	3-8	Periodic maintenance and lubrication chart .....	6-2	Checking the front fork .....	6-25
Handlebar switches .....	3-8	Removing and installing panels .....	6-5	Checking the steering .....	6-26
Clutch lever .....	3-10	Checking the spark plugs .....	6-6	Checking the wheel bearings .....	6-26
Shift pedal .....	3-10	Engine oil and oil filter cartridge .....	6-7	Battery .....	6-27
Brake lever .....	3-10	Coolant .....	6-10	Replacing the fuses .....	6-28
Brake pedal .....	3-11	Replacing the air filter element .....	6-12	Replacing the headlight bulb .....	6-29
Fuel tank cap .....	3-11	Adjusting the engine idling speed .....	6-13	Replacing the tail/brake light bulb .....	6-30
Fuel .....	3-12	Checking the throttle cable free play .....	6-14	Replacing a turn signal light bulb .....	6-31
Fuel tank breather hose .....	3-13	Valve clearance .....	6-14		
Catalytic converter .....	3-13	Tires .....	6-14		
Seat .....	3-13	Cast wheels .....	6-17		
Storage compartment .....	3-14	Adjusting the clutch lever free play .....	6-17		
Adjusting the shock absorber assembly .....	3-15				
Sidestand .....	3-16				
Ignition circuit cut-off system .....	3-16				

# TABLE OF CONTENTS

---

---

Replacing the license plate light bulb .....	6-31
Replacing an auxiliary light bulb ...	6-32
Front wheel .....	6-33
Rear wheel .....	6-34
Troubleshooting .....	6-36
Troubleshooting charts .....	6-37

## **MOTORCYCLE CARE AND**

<b>STORAGE</b> .....	7-1
Care .....	7-1
Storage .....	7-3

<b>SPECIFICATIONS</b> .....	8-1
-----------------------------	-----

<b>CONSUMER INFORMATION</b> .....	9-1
Identification numbers .....	9-1

# SAFETY INFORMATION

EAU10281

1

MOTORCYCLES ARE SINGLE TRACK VEHICLES. THEIR SAFE USE AND OPERATION ARE DEPENDENT UPON THE USE OF PROPER RIDING TECHNIQUES AS WELL AS THE EXPERTISE OF THE OPERATOR. EVERY OPERATOR SHOULD KNOW THE FOLLOWING REQUIREMENTS BEFORE RIDING THIS MOTORCYCLE.

HE OR SHE SHOULD:

- OBTAIN THOROUGH INSTRUCTIONS FROM A COMPETENT SOURCE ON ALL ASPECTS OF MOTORCYCLE OPERATION.
- OBSERVE THE WARNINGS AND MAINTENANCE REQUIREMENTS IN THE OWNER'S MANUAL.
- OBTAIN QUALIFIED TRAINING IN SAFE AND PROPER RIDING TECHNIQUES.
- OBTAIN PROFESSIONAL TECHNICAL SERVICE AS INDICATED BY THE OWNER'S MANUAL

AND/OR WHEN MADE NECESSARY BY MECHANICAL CONDITIONS.

## Safe riding

- Always make pre-operation checks. Careful checks may help prevent an accident.
- This motorcycle is designed to carry the operator and a passenger.
- The failure of motorists to detect and recognize motorcycles in traffic is the predominating cause of automobile/motorcycle accidents. Many accidents have been caused by an automobile driver who did not see the motorcycle. Making yourself conspicuous appears to be very effective in reducing the chance of this type of accident.

## Therefore:

- Wear a brightly colored jacket.
- Use extra caution when you are approaching and passing through intersections, since intersections are the most likely places for motorcycle accidents to occur.

- Ride where other motorists can see you. Avoid riding in another motorist's blind spot.
- Many accidents involve inexperienced operators. In fact, many operators who have been involved in accidents do not even have a current motorcycle license.
- Make sure that you are qualified and that you only lend your motorcycle to other qualified operators.
- Know your skills and limits. Staying within your limits may help you to avoid an accident.
- We recommend that you practice riding your motorcycle where there is no traffic until you have become thoroughly familiar with the motorcycle and all of its controls.
- Many accidents have been caused by error of the motorcycle operator. A typical error made by the operator is veering wide on a turn



due to EXCESSIVE SPEED or undercornering (insufficient lean angle for the speed).

- Always obey the speed limit and never travel faster than warranted by road and traffic conditions.
- Always signal before turning or changing lanes. Make sure that other motorists can see you.
- The posture of the operator and passenger is important for proper control.
  - The operator should keep both hands on the handlebar and both feet on the operator footrests during operation to maintain control of the motorcycle.
  - The passenger should always hold onto the operator, the seat strap or grab bar, if equipped, with both hands and keep both feet on the passenger footrests.
  - Never carry a passenger unless he or she can firmly place both feet on the passenger footrests.
- Never ride under the influence of alcohol or other drugs.

- This motorcycle is designed for on-road use only. It is not suitable for off-road use.

### **Protective apparel**

The majority of fatalities from motorcycle accidents are the result of head injuries. The use of a safety helmet is the single most critical factor in the prevention or reduction of head injuries.

- Always wear an approved helmet.
- Wear a face shield or goggles. Wind in your unprotected eyes could contribute to an impairment of vision that could delay seeing a hazard.
- The use of a jacket, heavy boots, trousers, gloves, etc., is effective in preventing or reducing abrasions or lacerations.
- Never wear loose-fitting clothes, otherwise they could catch on the control levers, footrests, or wheels and cause injury or an accident.
- Never touch the engine or exhaust system during or after operation. They become very hot and can

cause burns. Always wear protective clothing that covers your legs, ankles, and feet.

- A passenger should also observe the above precautions.

### **Modifications**

Modifications made to this motorcycle not approved by Yamaha, or the removal of original equipment, may render the motorcycle unsafe for use and may cause severe personal injury. Modifications may also make your motorcycle illegal to use.

### **Loading and accessories**

Adding accessories or cargo to your motorcycle can adversely affect stability and handling if the weight distribution of the motorcycle is changed. To avoid the possibility of an accident, use extreme caution when adding cargo or accessories to your motorcycle. Use extra care when riding a motorcycle that has added cargo or accessories. Here are some general guidelines to follow if loading cargo or adding accessories to your motorcycle:

# SAFETY INFORMATION

## Loading

The total weight of the operator, passenger, accessories and cargo must not exceed the maximum load limit.

**Maximum load:**  
190 kg (419 lb)

When loading within this weight limit, keep the following in mind:

- Cargo and accessory weight should be kept as low and close to the motorcycle as possible. Make sure to distribute the weight as evenly as possible on both sides of the motorcycle to minimize imbalance or instability.
- Shifting weights can create a sudden imbalance. Make sure that accessories and cargo are securely attached to the motorcycle before riding. Check accessory mounts and cargo restraints frequently.
- Never attach any large or heavy items to the handlebar, front fork, or front fender. These items, including such cargo as sleeping

bags, duffel bags, or tents, can create unstable handling or a slow steering response.

## Accessories

Genuine Yamaha accessories have been specifically designed for use on this motorcycle. Since Yamaha cannot test all other accessories that may be available, you must personally be responsible for the proper selection, installation and use of non-Yamaha accessories. Use extreme caution when selecting and installing any accessories.

Keep the following guidelines in mind, as well as those provided under “Loading” when mounting accessories.

- Never install accessories or carry cargo that would impair the performance of your motorcycle. Carefully inspect the accessory before using it to make sure that it does not in any way reduce ground clearance or cornering clearance,

limit suspension travel, steering travel or control operation, or obscure lights or reflectors.

- Accessories fitted to the handlebar or the front fork area can create instability due to improper weight distribution or aerodynamic changes. If accessories are added to the handlebar or front fork area, they must be as lightweight as possible and should be kept to a minimum.
- Bulky or large accessories may seriously affect the stability of the motorcycle due to aerodynamic effects. Wind may attempt to lift the motorcycle, or the motorcycle may become unstable in cross winds. These accessories may also cause instability when passing or being passed by large vehicles.
- Certain accessories can displace the operator from his or her normal riding position. This improper position limits the freedom of movement of the opera-

tor and may limit control ability, therefore, such accessories are not recommended.

- Use caution when adding electrical accessories. If electrical accessories exceed the capacity of the motorcycle's electrical system, an electric failure could result, which could cause a dangerous loss of lights or engine power.

### **Gasoline and exhaust gas**

- **GASOLINE IS HIGHLY FLAMMABLE:**
  - Always turn the engine off when refueling.
  - Take care not to spill any gasoline on the engine or exhaust system when refueling.
  - Never refuel while smoking or in the vicinity of an open flame.
- Never start the engine or let it run for any length of time in a closed area. The exhaust fumes are poisonous and may cause loss of consciousness and death within a short time. Always operate your motorcycle in an area that has adequate ventilation.

- Always turn the engine off before leaving the motorcycle unattended and remove the key from the main switch. When parking the motorcycle, note the following:
  - The engine and exhaust system may be hot, therefore, park the motorcycle in a place where pedestrians or children are not likely to touch these hot areas.
  - Do not park the motorcycle on a slope or soft ground, otherwise it may fall over.
  - Do not park the motorcycle near a flammable source, (e.g., a kerosene heater, or near an open flame), otherwise it could catch fire.
- When transporting the motorcycle in another vehicle, make sure that it is kept upright. If the motorcycle should lean over, gasoline may leak out of the fuel tank.
- If you should swallow any gasoline, inhale a lot of gasoline vapor, or allow gasoline to get into your eyes, see your doctor immediately. If any gasoline spills on your skin

or clothing, immediately wash the affected area with soap and water and change your clothes.

# DESCRIPTION

EAU10410

## Left view

2

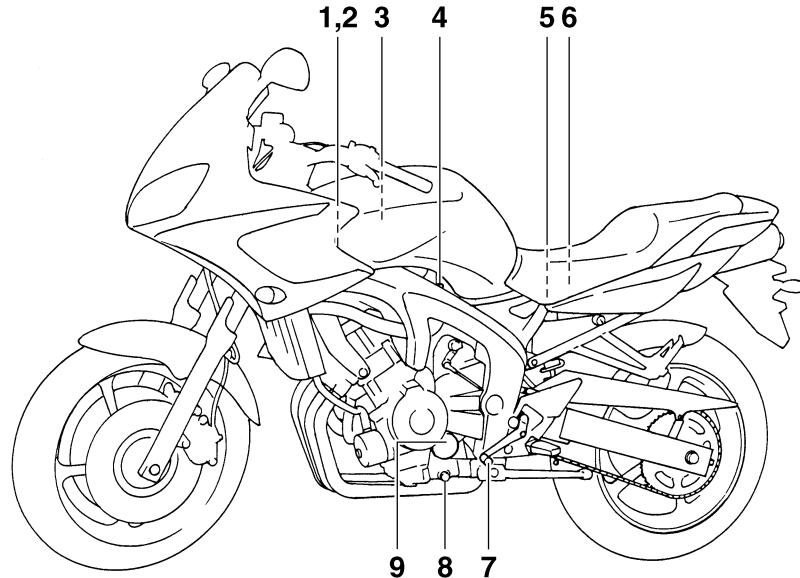

1. Main fuse (page 6-28)

2. Battery (page 6-27)

3. Air filter element (page 6-12)

4. Idle adjusting screw (page 6-13)

5. Shock absorber assembly spring preload adjusting ring (page 3-15)

6. Owner's tool kit (page 6-1)

7. Shift pedal (page 3-10)

8. Engine oil drain bolt (page 6-7)

9. Engine oil filter cartridge (page 6-7)

## Right view

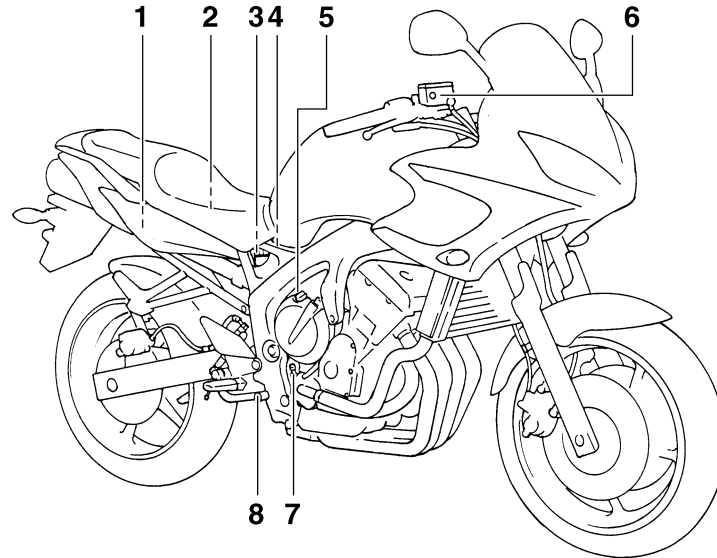

1. Fuse box (page 6-28)
2. Storage compartment (page 3-14)
3. Rear brake fluid reservoir (page 6-19)
4. Coolant reservoir cap (page 6-10)
5. Engine oil filler cap (page 6-7)
6. Front brake fluid reservoir (page 6-19)
7. Dipstick (page 6-7)
8. Brake pedal (page 3-11)

# DESCRIPTION

---

EAU10430

## Controls and instruments

2

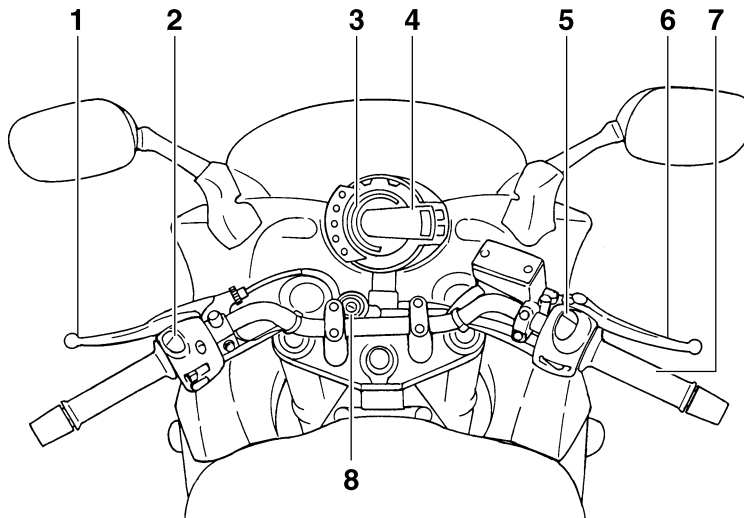

1. Clutch lever (page 3-10)
2. Left handlebar switches (page 3-8)
3. LCD tachometer (page 3-5)
4. Multi-function display (page 3-5)
5. Right handlebar switches (page 3-8)
6. Brake lever (page 3-10)
7. Throttle grip (page 6-14)
8. Main switch/steering lock (page 3-2)

## Immobilizer system

EAU10972

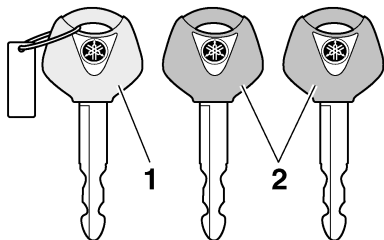

1. Code re-registering key (red bow)
2. Standard keys (black bow)

This vehicle is equipped with an immobilizer system to help prevent theft by re-registering codes in the standard keys. This system consists of the following.

- a code re-registering key (with a red bow)
- two standard keys (with a black bow) that can be re-registered with new codes
- a transponder (which is installed in the code re-registering key)
- an immobilizer unit
- an ECU

- an immobilizer system indicator light (See page 3-3.)
- The key with the red bow is used to register codes in each standard key. Since re-registering is a difficult process, take the vehicle along with all three keys to a Yamaha dealer to have them re-registered. Do not use the key with the red bow for driving. It should only be used for re-registering the standard keys. Always use a standard key for driving.

ECA11820

### CAUTION:

- **DO NOT LOSE THE CODE RE-REGISTERING KEY! CONTACT YOUR DEALER IMMEDIATELY IF IT IS LOST!** If the code re-registering key is lost, registering new codes in the standard keys is impossible. The standard keys can still be used to start the vehicle, however if code re-registering is required (i.e., if a new standard key is made or all keys are lost) the entire immobilizer system must be replaced. Therefore, it is highly recom-

mended to use either standard key and keep the code re-registering key in a safe place.

- Do not submerge any key in water.
- Do not expose any key to excessively high temperatures.
- Do not place any key close to magnets (this includes, but not limited to, products such as speakers, etc.).
- Do not place heavy items on any key.
- Do not grind any key or alter its shape.
- Do not disassemble the plastic part of any key.
- Do not put two keys of any immobilizer system on the same key ring.
- Keep the standard keys as well as keys of other immobilizer systems away from this vehicle's code re-registering key.
- Keep other immobilizer system keys away from the main switch as they may cause signal interference.

# INSTRUMENT AND CONTROL FUNCTIONS

## Main switch/steering lock

EAU10471

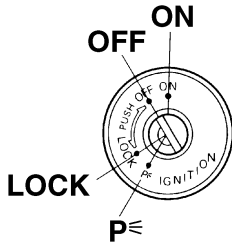

The main switch/steering lock controls the ignition and lighting systems, and is used to lock the steering.

**NOTE:** \_\_\_\_\_  
Be sure to use the standard key (black bow) for regular use of the vehicle. To minimize the risk of losing the code re-registering key (red bow), keep it in a safe place and only use it for code re-registering.

### ON

EAU10550

All electrical circuits are supplied with power, the meter lighting, taillight, license plate light and auxiliary lights come on, and the engine can be started. The key cannot be removed.

**NOTE:** \_\_\_\_\_  
The headlights come on automatically when the engine is started and stay on until the key is turned to "OFF", even if the engine stalls.

### OFF

EAU10660

All electrical systems are off. The key can be removed.

### LOCK

EAU10680

The steering is locked, and all electrical systems are off. The key can be removed.

## To lock the steering

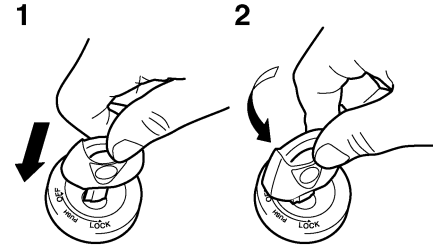

1. Push.
2. Turn.

1. Turn the handlebars all the way to the left.
2. Push the key in from the "OFF" position, and then turn it to "LOCK" while still pushing it.
3. Remove the key.



# INSTRUMENT AND CONTROL FUNCTIONS

## To unlock the steering

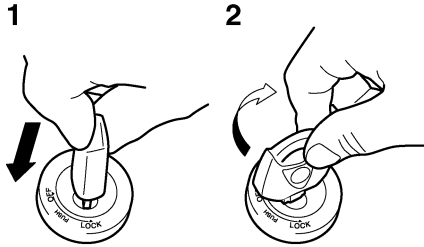

1. Push.
2. Turn.

Push the key in, and then turn it to “OFF” while still pushing it.

EWA10060

### **WARNING**

Never turn the key to “OFF” or “LOCK” while the vehicle is moving, otherwise the electrical systems will be switched off, which may result in loss of control or an accident. Make sure that the vehicle is stopped before turning the key to “OFF” or “LOCK”.

## **p** (Parking)

EAU10940

The steering is locked, and the taillight, license plate light and auxiliary lights are on. The hazard light and turn signal lights can be turned on, but all other electrical systems are off. The key can be removed.

The steering must be locked before the key can be turned to “p”.

ECA11020

### **CAUTION:**

**Do not use the parking position for an extended length of time, otherwise the battery may discharge.**

## Indicator and warning lights

EAU11003

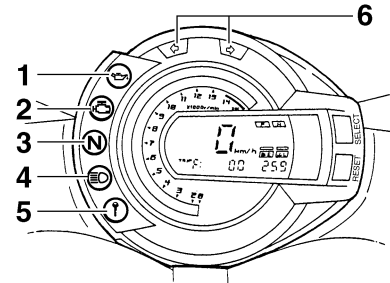

1. Oil level warning light “”
2. Engine trouble warning light “”
3. Neutral indicator light “N”
4. High beam indicator light “”
5. Immobilizer system indicator light “”
6. Turn signal indicator lights “” and “”

3

## Turn signal indicator lights “” and “”

EAU11030

The corresponding indicator light flashes when the turn signal switch is pushed to the left or right.

## Neutral indicator light “N”

EAU11060

This indicator light comes on when the transmission is in the neutral position.

# INSTRUMENT AND CONTROL FUNCTIONS

## High beam indicator light “”<sup>EAU11080</sup>

This indicator light comes on when the high beam of the headlight is switched on.

## Oil level warning light “”<sup>EAU11250</sup>

This warning light comes on when the engine oil level is low.

The electrical circuit of the warning light can be checked by turning the key to “ON”.

If the warning light does not come on for a few seconds, then go off, have a Yamaha dealer check the electrical circuit.

### NOTE: \_\_\_\_\_

- Even if the oil level is sufficient, the warning light may flicker when riding on a slope or during sudden acceleration or deceleration, but this is not a malfunction.
- This model is also equipped with a self-diagnosis device for the oil level detection circuit. If the oil level detection circuit is defective, the following cycle will be repeated until the malfunction is corrected: The

oil level warning light will flash ten times, then go off for 2.5 seconds. If this occurs, have a Yamaha dealer check the vehicle.

## Engine trouble warning light “”<sup>EAU11530</sup>

This warning light comes on or flashes when an electrical circuit monitoring the engine is defective. When this occurs, have a Yamaha dealer check the self-diagnosis system. (See page 3-5 for an explanation of the self-diagnosis device.)

The electrical circuit of the warning light can be checked by turning the key to “ON”. If the warning light does not come on for a few seconds, then go off, have a Yamaha dealer check the electrical circuit.

## Immobilizer system indicator light “”<sup>EAU26873</sup>

The electrical circuit of the indicator light can be checked by turning the key to “ON”.

If the indicator light does not come on for a few seconds, then go off, have a Yamaha dealer check the electrical circuit.

When the key is turned to “OFF” and 30 seconds have passed, the indicator light will start flashing indicating the immobilizer system is enabled. After 24 hours have passed, the indicator light will stop flashing, however the immobilizer system is still enabled.

This model is also equipped with a self-diagnosis device for the immobilizer system. (See page 3-5 for an explanation of the self-diagnosis device.)

# INSTRUMENT AND CONTROL FUNCTIONS

## LCD tachometer

EAU32922

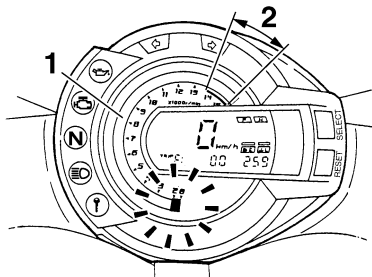

1. LCD tachometer
2. Tachometer red zone

The LCD tachometer allows the rider to monitor the engine speed and keep it within the ideal power range.

When the key is turned to “ON”, all of the display segments of the LCD tachometer will appear one after the other across the r/min range and then disappear, in order to test the electrical circuit.

### NOTE:

The first segment of the tachometer will flash while idling or riding until the coolant temperature has reached 60 °C (140 °F), so this is not a malfunction.

### CAUTION:

Do not operate the engine in the tachometer red zone.

Red zone: 14000 r/min and above

ECA10031

## Multi-function display

EAU32976

EWA12311

### WARNING

Be sure to stop the vehicle before making any setting changes to the multi-function display.

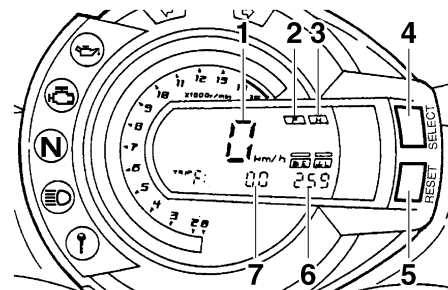

1. Speedometer
2. Fuel meter
3. Coolant temperature meter
4. “SELECT” button
5. “RESET” button
6. Clock/air intake temperature display
7. Odometer/tripmeters/digital tachometer

The multi-function display is equipped with the following:

- a speedometer (which shows the riding speed)

# INSTRUMENT AND CONTROL FUNCTIONS

---

3

- two tachometers, one LCD and one digital (which show engine r/min)
- an odometer (which shows the total distance traveled)
- two tripmeters (which show the distance traveled since they were last set to zero)
- a fuel reserve tripmeter (which shows the distance traveled since the bottom segment of the fuel meter started flashing)
- a clock
- an air intake temperature display
- a fuel meter
- a coolant temperature meter
- a self-diagnosis device

**NOTE:** \_\_\_\_\_

- Be sure to turn the key to “ON” before using the “SELECT” and “RESET” buttons.
  - For the U.K. only: To switch the speedometer and odometer/tripmeter displays between kilometers and miles, press the “SELECT” button for at least two seconds.
- 

**Odometer, tripmeter and digital tachometer modes**

Pushing the “SELECT” button switches the display between the odometer mode “ODO” and the tripmeter modes “TRIP 1” and “TRIP 2” (“TRIP F”) and the tachometer “E” in the following order:

ODO → TRIP 1 → TRIP 2 → (TRIP F) → E → ODO

When the fuel amount in the fuel tank decreases to 3.6 L (0.95 US gal) (0.79 Imp.gal), the bottom segment of the fuel meter will start flashing, and the odometer display will automatically change to the fuel reserve tripmeter mode “TRIP F” and start counting the distance traveled from that point. In that case, pushing the “SELECT” button switches the display between the various tripmeter and odometer modes in the following order:

TRIP F → E → ODO → TRIP 1 → TRIP 2 → TRIP F

To reset a tripmeter, select it by pushing the “SELECT” button, and then push the “RESET” button for at least one second. If you do not reset the fuel reserve tripmeter manually, it will reset

itself automatically and the display will return to the prior mode after refueling and traveling 5 km (3 mi).

**Clock**

To switch the air intake temperature display to the clock, first set the display to the odometer or tachometer mode, and then push the “RESET” button for at least two seconds.

**NOTE:** \_\_\_\_\_

The clock is automatically displayed when the key is turned to “OFF”.

---

To set the clock:

1. Push the “SELECT” button and “RESET” button together for at least two seconds.
2. When the hour digits start flashing, push the “RESET” button to set the hours.
3. Push the “SELECT” button, and the minute digits will start flashing.
4. Push the “RESET” button to set the minutes.
5. Push the “SELECT” button and then release it to start the clock.

# INSTRUMENT AND CONTROL FUNCTIONS

## Air intake temperature mode

The temperature displayed may vary from the outside temperature depending on engine conditions. To switch the clock to the air intake temperature mode, first set the display to the odometer or tachometer mode, and then push the “RESET” button for at least two seconds.

## Fuel meter

The fuel meter indicates the amount of fuel in the fuel tank. The display segments of the fuel meter disappear towards “E” (Empty) as the fuel level decreases. When only one segment is left near “E”, refuel as soon as possible.

### NOTE:

This fuel meter is equipped with a self-diagnosis system. If the electrical circuit is defective, the display segments will flash. If this occurs, have a Yamaha dealer check the electrical circuit.

## Coolant temperature meter

With the key in the “ON” position, the coolant temperature meter indicates the temperature of the coolant. When

the key is turned to “ON”, all of the display segments of the coolant temperature meter will appear one after the other and then disappear in order to test the electrical circuit. The coolant temperature varies with changes in the weather and engine load. If the top segment flashes, stop the vehicle and let the engine cool. (See page 6-37.)

ECA10020

### CAUTION:

**Do not operate the engine if it is overheated.**

## Self-diagnosis devices

This model is equipped with a self-diagnosis device for various electrical circuits.

If any of those circuits are defective, the engine trouble warning light will come on, and then the multi-function display will indicate a two-digit error code (e.g., 12, 13, 14).

This model is also equipped with a self-diagnosis device for the immobilizer system.

If any of the immobilizer system circuits are defective, the immobilizer system indicator light will flash, and then the multi-function display will indicate a two-digit error code (e.g., 51, 52, 53).

### NOTE:

If the multi-function display indicates error code 52 (all segments of the coolant temperature meter will come on, except the top segment, which will flash), this could be caused by transponder interference. If this error appears, try the following.

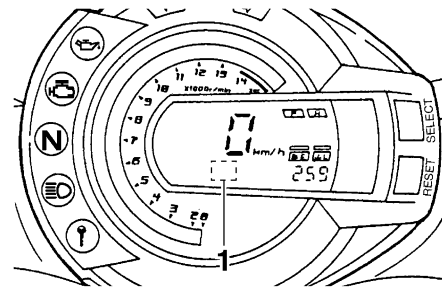

1. Error code display

1. Use the code re-registering key to start the engine.

# INSTRUMENT AND CONTROL FUNCTIONS

3

## NOTE: \_\_\_\_\_

Make sure there are no other immobilizer keys close to the main switch, and do not keep more than one immobilizer key on the same key ring! Immobilizer system keys may cause signal interference, which may prevent the engine from starting.

2. If the engine starts, turn it off, and try starting the engine with the standard keys.
3. If one or both of the standard keys do not start the engine, take the vehicle, the code re-registering key and both standard keys to a Yamaha dealer and have the standard keys re-registered.

If the multi-function display indicates any error code, note the code number, and then have a Yamaha dealer check the vehicle.

ECA11590

## CAUTION: \_\_\_\_\_

**If the display indicates an error code, the vehicle should be checked as soon as possible in order to avoid engine damage.**

EAU12331

## Anti-theft alarm (optional)

This model can be equipped with an optional anti-theft alarm by a Yamaha dealer. Contact a Yamaha dealer for more information.

EAU12344

## Handlebar switches

### Left

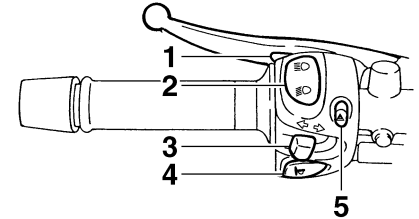

1. Pass switch “≡○”
2. Dimmer switch “≡○/≡○”
3. Turn signal switch “←/→”
4. Horn switch “🔊”
5. Hazard switch “△”

## Right

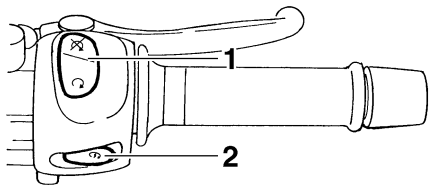

1. Engine stop switch “○/⊗”
2. Start switch “(🔊)”

### Pass switch “≡○”

EAU12350

Press this switch to flash the headlight.

### Dimmer switch “≡○/≡○”

EAU12400

Set this switch to “≡○” for the high beam and to “≡○” for the low beam.

### Turn signal switch “↔/↔”

EAU12460

To signal a right-hand turn, push this switch to “↔”. To signal a left-hand turn, push this switch to “↔”. When released, the switch returns to the center

position. To cancel the turn signal lights, push the switch in after it has returned to the center position.

### Horn switch “(🔊)”

EAU12500

Press this switch to sound the horn.

### Engine stop switch “○/⊗”

EAU12660

Set this switch to “○” before starting the engine. Set this switch to “⊗” to stop the engine in case of an emergency, such as when the vehicle overturns or when the throttle cable is stuck.

### Start switch “(🔊)”

EAU12710

Push this switch to crank the engine with the starter.

### CAUTION:

ECA10050

**See page 5-1 for starting instructions prior to starting the engine.**

### Hazard switch “(⚠)”

EAU12732

With the key in the “ON” or “P” position, use this switch to turn on the hazard light (simultaneous flashing of all turn signal lights).

The hazard light is used in case of an emergency or to warn other drivers when your vehicle is stopped where it might be a traffic hazard.

### CAUTION:

ECA10061

**Do not use the hazard lights for an extended length of time with the engine not running, otherwise the battery may discharge.**

# INSTRUMENT AND CONTROL FUNCTIONS

## Clutch lever

EAU12820

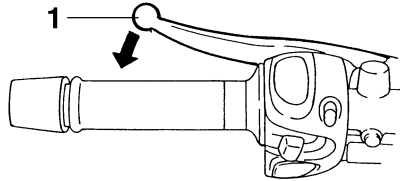

### 1. Clutch lever

The clutch lever is located at the left handlebar grip. To disengage the clutch, pull the lever toward the handlebar grip. To engage the clutch, release the lever. The lever should be pulled rapidly and released slowly for smooth clutch operation.

The clutch lever is equipped with a clutch switch, which is part of the ignition circuit cut-off system. (See page 3-16.)

## Shift pedal

EAU12870

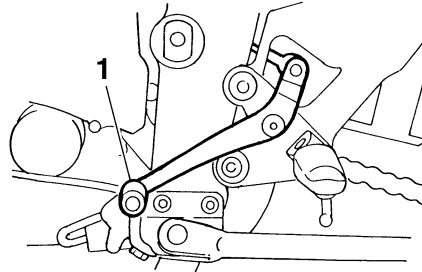

### 1. Shift pedal

The shift pedal is located on the left side of the engine and is used in combination with the clutch lever when shifting the gears of the 6-speed constant-mesh transmission equipped on this motorcycle.

## Brake lever

EAU26822

The brake lever is located at the right handlebar grip. To apply the front brake, pull the lever toward the handlebar grip.

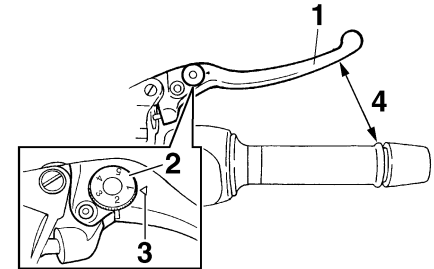

1. Brake lever
2. Brake lever position adjusting dial
3. “△” mark
4. Distance between brake lever and handlebar grip

The brake lever is equipped with a position adjusting dial. To adjust the distance between the brake lever and the handlebar grip, turn the adjusting dial while holding the lever pushed away from the handlebar grip. Make sure that the appropriate setting on the adjusting dial is aligned with the “△” mark on the brake lever.



# INSTRUMENT AND CONTROL FUNCTIONS

## Brake pedal

EAU12941

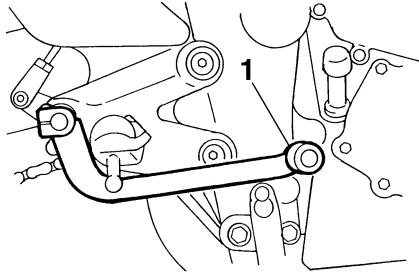

1. Brake pedal

The brake pedal is on the right side of the motorcycle. To apply the rear brake, press down on the brake pedal.

## Fuel tank cap

EAU13070

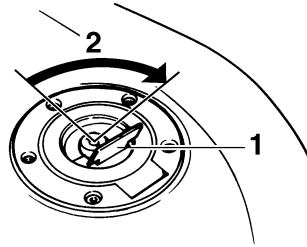

1. Fuel tank cap lock cover
2. Unlock.

### To open the fuel tank cap

Open the fuel tank cap lock cover, insert the key into the lock, and then turn it 1/4 turn clockwise. The lock will be released and the fuel tank cap can be opened.

### To close the fuel tank cap

1. Push the fuel tank cap into position with the key inserted in the lock.
2. Turn the key counterclockwise to the original position, remove it, and then close the lock cover.

### NOTE: \_\_\_\_\_

The fuel tank cap cannot be closed unless the key is in the lock. In addition, the key cannot be removed if the cap is not properly closed and locked.

EWA11090



**Make sure that the fuel tank cap is properly closed before riding.**

# INSTRUMENT AND CONTROL FUNCTIONS

## Fuel

EAU13220

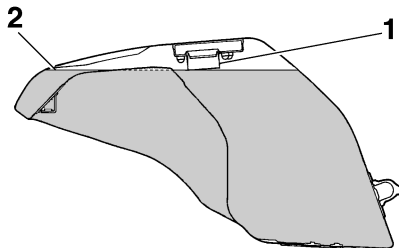

1. Fuel tank filler tube
2. Fuel level

Make sure that there is sufficient fuel in the tank. When refueling, be sure to insert the pump nozzle into the fuel tank filler hole and to fill the tank to the bottom of the filler tube as shown.

### **⚠ WARNING**

EWA10880

- Do not overfill the fuel tank, otherwise it may overflow when the fuel warms up and expands.
- Avoid spilling fuel on the hot engine.

ECA10070

### **CAUTION:**

Immediately wipe off spilled fuel with a clean, dry, soft cloth, since fuel may deteriorate painted surfaces or plastic parts.

EAU13320

### **Recommended fuel:**

REGULAR UNLEADED GASOLINE ONLY

### **Fuel tank capacity:**

19.4 L (5.13 US gal) (4.27 Imp.gal)

### **Fuel reserve amount:**

3.6 L (0.95 US gal) (0.79 Imp.gal)

ECA11400

### **CAUTION:**

Use only unleaded gasoline. The use of leaded gasoline will cause severe damage to internal engine parts, such as the valves and piston rings, as well as to the exhaust system.

Your Yamaha engine has been designed to use regular unleaded gasoline with a research octane number of 91 or higher. If knocking (or pinging) occurs, use a gasoline of a different brand

or premium unleaded fuel. Use of unleaded fuel will extend spark plug life and reduce maintenance costs.

## Fuel tank breather hose

EAU13410

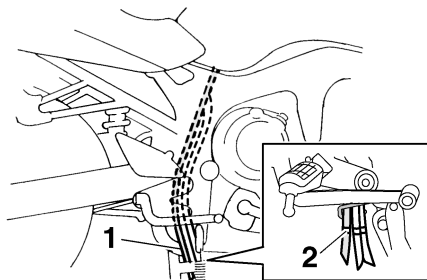

1. Fuel tank breather hose
2. White mark

Before operating the motorcycle:

- Check the fuel tank breather hose connection.
- Check the fuel tank breather hose for cracks or damage, and replace it if damaged.
- Make sure that the end of the fuel tank breather hose is not blocked, and clean it if necessary.

## Catalytic converter

EAU13431

This model is equipped with a catalytic converter in the exhaust system.

EWA10860

### **⚠ WARNING**

**The exhaust system is hot after operation. Make sure that the exhaust system has cooled down before doing any maintenance work.**

ECA10700

### **CAUTION:**

**The following precautions must be observed to prevent a fire hazard or other damages.**

- **Use only unleaded gasoline. The use of leaded gasoline will cause unreparable damage to the catalytic converter.**
- **Never park the vehicle near possible fire hazards such as grass or other materials that easily burn.**
- **Do not allow the engine to idle too long.**

## Seat

EAU32980

### To remove the seat

1. Insert the key into the seat lock, and then turn it counterclockwise.

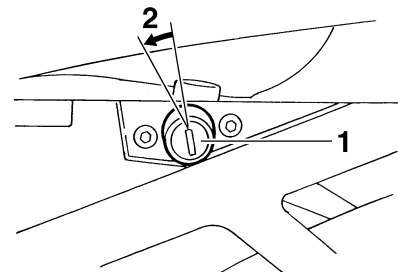

1. Seat lock
2. Unlock.

2. While holding the key in that position, lift the rear of the seat up, and then pull the seat off.

### To install the seat

1. Insert the projection on the front of the seat into the seat holder as shown.

# INSTRUMENT AND CONTROL FUNCTIONS

EAU14421

- Do not exceed the maximum load of 190 kg (419 lb) for the vehicle.

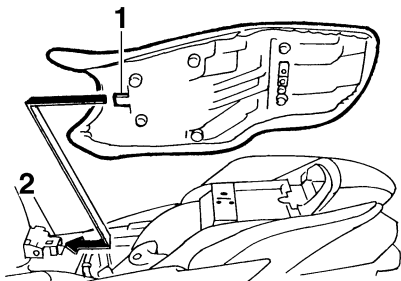

1. Projection
2. Seat holder

2. Push the rear of the seat down to lock it in place.
3. Remove the key.

**NOTE:** \_\_\_\_\_  
Make sure that the seat is properly secured before riding.  
\_\_\_\_\_

## Storage compartment

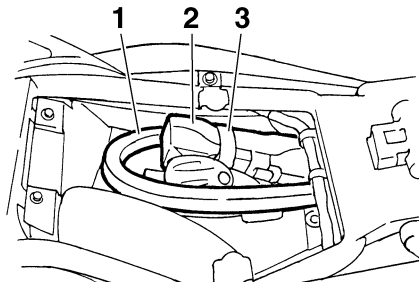

1. U-LOCK bar (optional)
2. Yamaha U-LOCK (optional)
3. Strap

This storage compartment is designed to hold a genuine Yamaha U-LOCK. (Other locks may not fit.) When placing a U-LOCK in the storage compartment, securely fasten it with the straps. When the U-LOCK is not in the storage compartment, be sure to secure the straps to prevent losing them.

EWA10961

### **WARNING**

- Do not exceed the load limit of 3 kg (7 lb) for the storage compartment.

# INSTRUMENT AND CONTROL FUNCTIONS

## Adjusting the shock absorber assembly

EAU36461

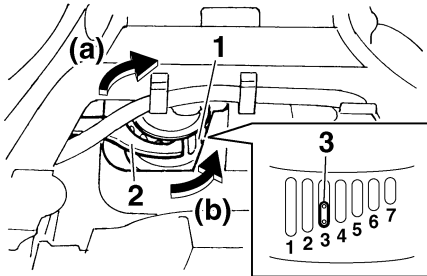

1. Spring preload adjusting ring
2. Special wrench
3. Position indicator

This shock absorber assembly is equipped with a spring preload adjusting ring.

ECA10100

### CAUTION:

**Never attempt to turn an adjusting mechanism beyond the maximum or minimum settings.**

Adjust the spring preload as follows.

1. Remove the seat. (See page 3-13.)

2. To increase the spring preload and thereby harden the suspension, turn the adjusting ring in direction (a). To decrease the spring preload and thereby soften the suspension, turn the adjusting ring in direction (b).

### NOTE:

- Align the appropriate notch in the adjusting ring with the position indicator on the shock absorber.
- Use the special wrench included in the owner's tool kit to make the adjustment.

### Spring preload setting:

Minimum (soft):

1

Standard:

3

Maximum (hard):

7

3. Install the seat.

EWA10220

### WARNING

**This shock absorber contains highly pressurized nitrogen gas. For proper handling, read and understand**

**the following information before handling the shock absorber. The manufacturer cannot be held responsible for property damage or personal injury that may result from improper handling.**

- Do not tamper with or attempt to open the gas cylinder.
- Do not subject the shock absorber to an open flame or other high heat sources, otherwise it may explode due to excessive gas pressure.
- Do not deform or damage the gas cylinder in any way, as this will result in poor damping performance.
- Always have a Yamaha dealer service the shock absorber.

# INSTRUMENT AND CONTROL FUNCTIONS

---

## Sidestand

EAU15301

The sidestand is located on the left side of the frame. Raise the sidestand or lower it with your foot while holding the vehicle upright.

### NOTE:

The built-in sidestand switch is part of the ignition circuit cut-off system, which cuts the ignition in certain situations. (See further down for an explanation of the ignition circuit cut-off system.)

EWA10240

### WARNING

**The vehicle must not be ridden with the sidestand down, or if the sidestand cannot be properly moved up (or does not stay up), otherwise the sidestand could contact the ground and distract the operator, resulting in a possible loss of control. Yamaha's ignition circuit cut-off system has been designed to assist the operator in fulfilling the responsibility of raising the sidestand before starting off. Therefore, check this system regularly as described**

**below and have a Yamaha dealer repair it if it does not function properly.**

---

EAU15321

## Ignition circuit cut-off system

The ignition circuit cut-off system (comprising the sidestand switch, clutch switch and neutral switch) has the following functions.

- It prevents starting when the transmission is in gear and the sidestand is up, but the clutch lever is not pulled.
- It prevents starting when the transmission is in gear and the clutch lever is pulled, but the sidestand is still down.
- It cuts the running engine when the transmission is in gear and the sidestand is moved down.

Periodically check the operation of the ignition circuit cut-off system according to the following procedure.

EWA10260

### WARNING

- **The vehicle must be placed on the centerstand during this inspection.**
  - **If a malfunction is noted, have a Yamaha dealer check the system before riding.**
-

# INSTRUMENT AND CONTROL FUNCTIONS

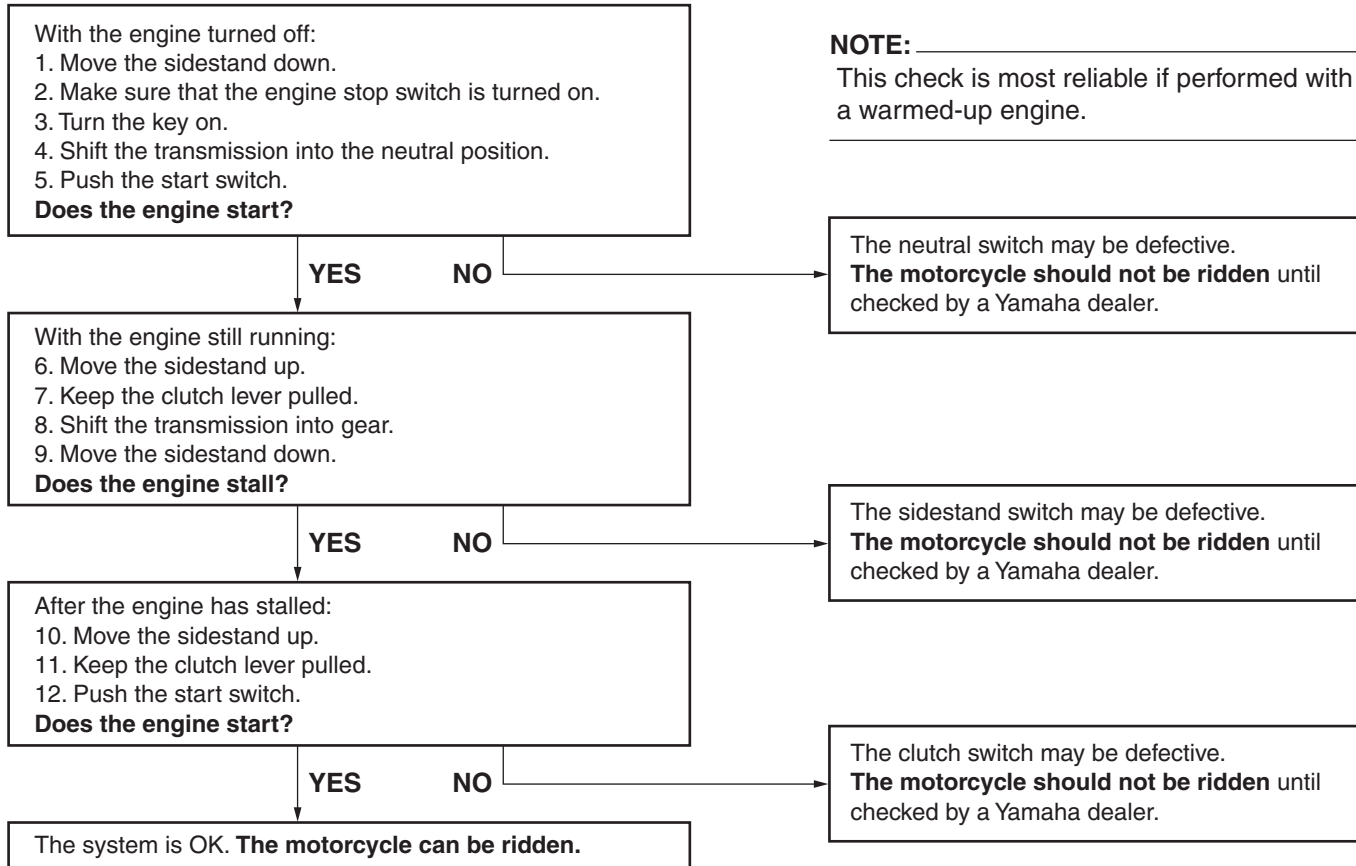

# PRE-OPERATION CHECKS

---

---

EAU15591

The condition of a vehicle is the owner's responsibility. Vital components can start to deteriorate quickly and unexpectedly, even if the vehicle remains unused (for example, as a result of exposure to the elements). Any damage, fluid leakage or loss of tire air pressure could have serious consequences. Therefore, it is very important, in addition to a thorough visual inspection, to check the following points before each ride.

## NOTE:

Pre-operation checks should be made each time the vehicle is used. Such an inspection can be accomplished in a very short time; and the added safety it assures is more than worth the time involved.

EWA11150

4



**If any item in the Pre-operation check list is not working properly, have it inspected and repaired before operating the vehicle.**

---



# PRE-OPERATION CHECKS

EAU15603

## Pre-operation check list

ITEM	CHECKS	PAGE
<b>Fuel</b>	<ul style="list-style-type: none"><li>• Check fuel level in fuel tank.</li><li>• Refuel if necessary.</li><li>• Check fuel line for leakage.</li></ul>	3-12
<b>Engine oil</b>	<ul style="list-style-type: none"><li>• Check oil level in engine.</li><li>• If necessary, add recommended oil to specified level.</li><li>• Check vehicle for oil leakage.</li></ul>	6-7
<b>Coolant</b>	<ul style="list-style-type: none"><li>• Check coolant level in reservoir.</li><li>• If necessary, add recommended coolant to specified level.</li><li>• Check cooling system for leakage.</li></ul>	6-10
<b>Front brake</b>	<ul style="list-style-type: none"><li>• Check operation.</li><li>• If soft or spongy, have Yamaha dealer bleed hydraulic system.</li><li>• Check brake pads for wear.</li><li>• Replace if necessary.</li><li>• Check fluid level in reservoir.</li><li>• If necessary, add recommended brake fluid to specified level.</li><li>• Check hydraulic system for leakage.</li></ul>	6-18, 6-19
<b>Rear brake</b>	<ul style="list-style-type: none"><li>• Check operation.</li><li>• If soft or spongy, have Yamaha dealer bleed hydraulic system.</li><li>• Check brake pads for wear.</li><li>• Replace if necessary.</li><li>• Check fluid level in reservoir.</li><li>• If necessary, add recommended brake fluid to specified level.</li><li>• Check hydraulic system for leakage.</li></ul>	6-18, 6-19
<b>Clutch</b>	<ul style="list-style-type: none"><li>• Check operation.</li><li>• Lubricate cable if necessary.</li><li>• Check lever free play.</li><li>• Adjust if necessary.</li></ul>	6-17

# PRE-OPERATION CHECKS

ITEM	CHECKS	PAGE
<b>Throttle grip</b>	<ul style="list-style-type: none"> <li>• Make sure that operation is smooth.</li> <li>• Check cable free play.</li> <li>• If necessary, have Yamaha dealer adjust cable free play and lubricate cable and grip housing.</li> </ul>	6-14, 6-23
<b>Control cables</b>	<ul style="list-style-type: none"> <li>• Make sure that operation is smooth.</li> <li>• Lubricate if necessary.</li> </ul>	6-22
<b>Drive chain</b>	<ul style="list-style-type: none"> <li>• Check chain slack.</li> <li>• Adjust if necessary.</li> <li>• Check chain condition.</li> <li>• Lubricate if necessary.</li> </ul>	6-20, 6-22
<b>Wheels and tires</b>	<ul style="list-style-type: none"> <li>• Check for damage.</li> <li>• Check tire condition and tread depth.</li> <li>• Check air pressure.</li> <li>• Correct if necessary.</li> </ul>	6-14, 6-17
<b>Brake and shift pedals</b>	<ul style="list-style-type: none"> <li>• Make sure that operation is smooth.</li> <li>• Lubricate pedal pivoting points if necessary.</li> </ul>	6-23
<b>Brake and clutch levers</b>	<ul style="list-style-type: none"> <li>• Make sure that operation is smooth.</li> <li>• Lubricate lever pivoting points if necessary.</li> </ul>	6-24
<b>Centerstand, sidestand</b>	<ul style="list-style-type: none"> <li>• Make sure that operation is smooth.</li> <li>• Lubricate pivots if necessary.</li> </ul>	6-24
<b>Chassis fasteners</b>	<ul style="list-style-type: none"> <li>• Make sure that all nuts, bolts and screws are properly tightened.</li> <li>• Tighten if necessary.</li> </ul>	—
<b>Instruments, lights, signals and switches</b>	<ul style="list-style-type: none"> <li>• Check operation.</li> <li>• Correct if necessary.</li> </ul>	—
<b>Sidestand switch</b>	<ul style="list-style-type: none"> <li>• Check operation of ignition circuit cut-off system.</li> <li>• If system is defective, have Yamaha dealer check vehicle.</li> </ul>	3-16

# OPERATION AND IMPORTANT RIDING POINTS

EAU15950

EWA10270

## **WARNING**

- Become thoroughly familiar with all operating controls and their functions before riding. Consult a Yamaha dealer regarding any control or function that you do not thoroughly understand.
- Never start the engine or operate it in a closed area for any length of time. Exhaust fumes are poisonous, and inhaling them can cause loss of consciousness and death within a short time. Always make sure that there is adequate ventilation.
- Before starting out, make sure that the sidestand is up. If the sidestand is not raised completely, it could contact the ground and distract the operator, resulting in a possible loss of control.

## Starting the engine

In order for the ignition circuit cut-off system to enable starting, one of the following conditions must be met:

- The transmission is in the neutral position.
- The transmission is in gear with the clutch lever pulled and the sidestand up.

## **WARNING**

- Before starting the engine, check the function of the ignition circuit cut-off system according to the procedure described on page 3-16.
- Never ride with the sidestand down.

1. Turn the key to "ON" and make sure that the engine stop switch is set to "○".

## **CAUTION:**

The following warning lights and indicator light should come on for a few seconds, then go off.

- Oil level warning light
- Engine trouble warning light

EAU32951

- Immobilizer system indicator light

If a warning or indicator light does not go off, see page 3-3 for the corresponding warning and indicator light circuit check.

2. Shift the transmission into the neutral position.

## **NOTE:**

When the transmission is in the neutral position, the neutral indicator light should be on, otherwise have a Yamaha dealer check the electrical circuit.

3. Start the engine by pushing the start switch.

## **NOTE:**

If the engine fails to start, release the start switch, wait a few seconds, and then try again. Each starting attempt should be as short as possible to preserve the battery. Do not crank the engine more than 10 seconds on any one attempt.

# OPERATION AND IMPORTANT RIDING POINTS

ECA11040

## CAUTION:

For maximum engine life, never accelerate hard when the engine is cold!

## NOTE:

The engine is warm when it quickly responds to the throttle.

EAU16671

## Shifting

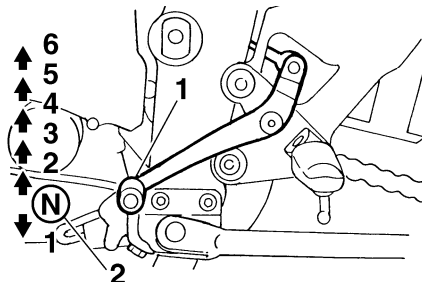

1. Shift pedal
2. Neutral position

Shifting gears lets you control the amount of engine power available for starting off, accelerating, climbing hills, etc.

The gear positions are shown in the illustration.

## NOTE:

To shift the transmission into the neutral position, press the shift pedal down repeatedly until it reaches the end of its travel, and then slightly raise it.

ECA10260

## CAUTION:

- Even with the transmission in the neutral position, do not coast for long periods of time with the engine off, and do not tow the motorcycle for long distances. The transmission is properly lubricated only when the engine is running. Inadequate lubrication may damage the transmission.
- Always use the clutch while changing gears to avoid damaging the engine, transmission, and drive train, which are not designed to withstand the shock of forced shifting.

## Tips for reducing fuel consumption

EAU16810

Fuel consumption depends largely on your riding style. Consider the following tips to reduce fuel consumption:

- Shift up swiftly, and avoid high engine speeds during acceleration.
- Do not rev the engine while shifting down, and avoid high engine speeds with no load on the engine.
- Turn the engine off instead of letting it idle for an extended length of time (e.g., in traffic jams, at traffic lights or at railroad crossings).

## Engine break-in

EAU16841

There is never a more important period in the life of your engine than the period between 0 and 1600 km (1000 mi). For this reason, you should read the following material carefully.

Since the engine is brand new, do not put an excessive load on it for the first 1600 km (1000 mi). The various parts in the engine wear and polish themselves to the correct operating clearances. During this period, prolonged full-throttle operation or any condition that might result in engine overheating must be avoided.

EAU17091

### 0–1000 km (0–600 mi)

Avoid prolonged operation above 7000 r/min.

### 1000–1600 km (600–1000 mi)

Avoid prolonged operation above 8400 r/min.

ECA10301

### CAUTION:

**After 1000 km (600 mi) of operation, the engine oil must be changed and the oil filter cartridge or element replaced.**

### 1600 km (1000 mi) and beyond

The vehicle can now be operated normally.

ECA10310

### CAUTION:

- Keep the engine speed out of the tachometer red zone.
- If any engine trouble should occur during the engine break-in period, immediately have a Yamaha dealer check the vehicle.

# OPERATION AND IMPORTANT RIDING POINTS

---

EAU17212

## Parking

When parking, stop the engine, and then remove the key from the main switch.

EWA10310

### **WARNING**

- Since the engine and exhaust system can become very hot, park in a place where pedestrians or children are not likely to touch them.
- Do not park on a slope or on soft ground, otherwise the vehicle may overturn.

ECA10380

### **CAUTION:**

Never park in an area where there are fire hazards such as grass or other flammable materials.

---

EAU17240

EAU17520

EWA10350

Safety is an obligation of the owner. Periodic inspection, adjustment and lubrication will keep your vehicle in the safest and most efficient condition possible. The most important points of inspection, adjustment, and lubrication are explained on the following pages. The intervals given in the periodic maintenance and lubrication chart should be simply considered as a general guide under normal riding conditions. However, DEPENDING ON THE WEATHER, TERRAIN, GEOGRAPHICAL LOCATION, AND INDIVIDUAL USE, THE MAINTENANCE INTERVALS MAY NEED TO BE SHORTENED.

EWA10320

## **! WARNING**

**If you are not familiar with maintenance work, have a Yamaha dealer do it for you.**

## Owner's tool kit

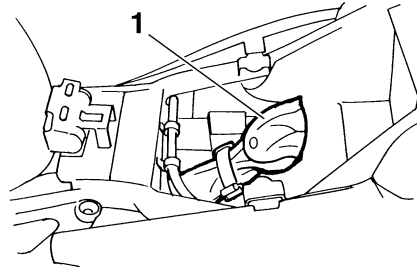

### 1. Owner's tool kit

The owner's tool kit is located inside the storage compartment under the seat. (See page 3-13.)

The service information included in this manual and the tools provided in the owner's tool kit are intended to assist you in the performance of preventive maintenance and minor repairs. However, additional tools such as a torque wrench may be necessary to perform certain maintenance work correctly.

### NOTE:

If you do not have the tools or experience required for a particular job, have a Yamaha dealer perform it for you.

## **! WARNING**

**Modifications not approved by Yamaha may cause loss of performance and render the vehicle unsafe for use. Consult a Yamaha dealer before attempting any changes.**

# PERIODIC MAINTENANCE AND MINOR REPAIR

EAU17705

## Periodic maintenance and lubrication chart

### NOTE:

- The annual checks must be performed every year, except if a kilometer-based maintenance is performed instead.
- From 50000 km, repeat the maintenance intervals starting from 10000 km.
- Items marked with an asterisk should be performed by a Yamaha dealer as they require special tools, data and technical skills.

NO.	ITEM	CHECK OR MAINTENANCE JOB	ODOMETER READING (× 1000 km)					ANNUAL CHECK
			1	10	20	30	40	
1	* Fuel line	• Check fuel hoses for cracks or damage.		√	√	√	√	√
2	* Spark plugs	• Check condition. • Clean and regap.		√		√		
		• Replace.			√		√	
3	* Valves	• Check valve clearance. • Adjust.	Every 40000 km					
4	Air filter element	• Replace.					√	
5	Clutch	• Check operation. • Adjust.	√	√	√	√	√	
6	* Front brake	• Check operation, fluid level and vehicle for fluid leakage.	√	√	√	√	√	√
		• Replace brake pads.	Whenever worn to the limit					
7	* Rear brake	• Check operation, fluid level and vehicle for fluid leakage.	√	√	√	√	√	√
		• Replace brake pads.	Whenever worn to the limit					
8	* Brake hoses	• Check for cracks or damage.		√	√	√	√	√
		• Replace.	Every 4 years					
9	* Wheels	• Check runout and for damage.		√	√	√	√	



# PERIODIC MAINTENANCE AND MINOR REPAIR

NO.	ITEM	CHECK OR MAINTENANCE JOB	ODOMETER READING (× 1000 km)					ANNUAL CHECK
			1	10	20	30	40	
10	* Tires	<ul style="list-style-type: none"> <li>• Check tread depth and for damage.</li> <li>• Replace if necessary.</li> <li>• Check air pressure.</li> <li>• Correct if necessary.</li> </ul>		√	√	√	√	√
11	* Wheel bearings	<ul style="list-style-type: none"> <li>• Check bearing for looseness or damage.</li> </ul>		√	√	√	√	
12	* Swingarm	<ul style="list-style-type: none"> <li>• Check operation and for excessive play.</li> <li>• Lubricate with lithium-soap-based grease.</li> </ul>		√	√	√	√	
13	Drive chain	<ul style="list-style-type: none"> <li>• Check chain slack, alignment and condition.</li> <li>• Adjust and lubricate chain with a special O-ring chain lubricant thoroughly.</li> </ul>	Every 800 km and after washing the motorcycle or riding in the rain					
14	* Steering bearings	<ul style="list-style-type: none"> <li>• Check bearing play and steering for roughness.</li> <li>• Lubricate with lithium-soap-based grease.</li> </ul>	√	√	√	√	√	
15	* Chassis fasteners	<ul style="list-style-type: none"> <li>• Make sure that all nuts, bolts and screws are properly tightened.</li> </ul>		√	√	√	√	√
16	Sidestand, centerstand	<ul style="list-style-type: none"> <li>• Check operation.</li> <li>• Lubricate.</li> </ul>		√	√	√	√	√
17	* Sidestand switch	<ul style="list-style-type: none"> <li>• Check operation.</li> </ul>	√	√	√	√	√	√
18	* Front fork	<ul style="list-style-type: none"> <li>• Check operation and for oil leakage.</li> </ul>		√	√	√	√	
19	* Shock absorber assembly	<ul style="list-style-type: none"> <li>• Check operation and shock absorber for oil leakage.</li> </ul>		√	√	√	√	
20	* Fuel injection	<ul style="list-style-type: none"> <li>• Adjust engine idling speed and synchronization.</li> </ul>	√	√	√	√	√	√
21	Engine oil	<ul style="list-style-type: none"> <li>• Change.</li> <li>• Check oil level and vehicle for oil leakage.</li> </ul>	√	√	√	√	√	√
22	Engine oil filter cartridge	<ul style="list-style-type: none"> <li>• Replace.</li> </ul>	√		√		√	

# PERIODIC MAINTENANCE AND MINOR REPAIR

NO.	ITEM	CHECK OR MAINTENANCE JOB	ODOMETER READING (× 1000 km)					ANNUAL CHECK
			1	10	20	30	40	
23	*	<b>Cooling system</b> • Check coolant level and vehicle for coolant leakage. • Change.		√	√	√	√	√
			Every 3 years					
24	*	<b>Front and rear brake switches</b> • Check operation.	√	√	√	√	√	√
25		<b>Moving parts and cables</b> • Lubricate.		√	√	√	√	√
26	*	<b>Throttle grip housing and cable</b> • Check operation and free play. • Adjust the throttle cable free play if necessary. • Lubricate the throttle grip housing and cable.		√	√	√	√	√
27	*	<b>Air induction system</b> • Check the air cut-off valve, reed valve, and hose for damage. • Replace the entire air induction system if necessary.		√	√	√	√	√
28	*	<b>Muffler and exhaust pipe</b> • Check the screw clamp for looseness.	√	√	√	√	√	
29	*	<b>Lights, signals and switches</b> • Check operation. • Adjust headlight beam.	√	√	√	√	√	√

EAU18670

## NOTE:

- The air filter needs more frequent service if you are riding in unusually wet or dusty areas.
- Hydraulic brake service
  - Regularly check and, if necessary, correct the brake fluid level.
  - Every two years replace the internal components of the brake master cylinders and calipers, and change the brake fluid.
  - Replace the brake hoses every four years and if cracked or damaged.

# PERIODIC MAINTENANCE AND MINOR REPAIR

## Removing and installing panels

EAU18771

The panels shown need to be removed to perform some of the maintenance jobs described in this chapter. Refer to this section each time a panel needs to be removed and installed.

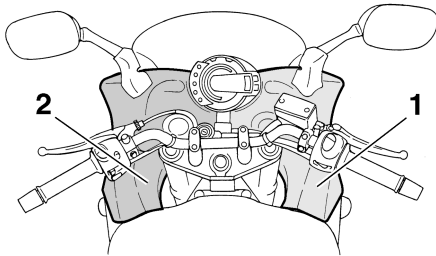

1. Panel A
2. Panel B

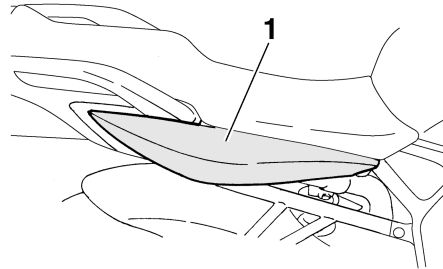

1. Panel C

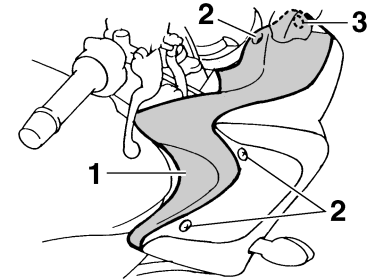

1. Panel A
2. Bolt
3. Quick fastener screw

## Panels A and B

EAU32863

### To remove one of the panels

Remove the bolts and the quick fastener screw, and then pull the panel off as shown.

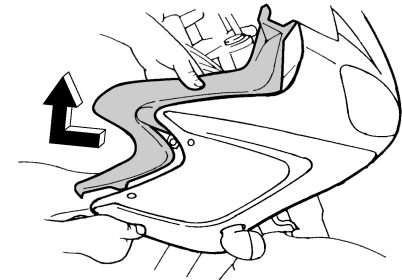

### To install the panel

Place the panel in the original position, and then install the quick fastener screw and the bolts.

# PERIODIC MAINTENANCE AND MINOR REPAIR

EAU33020

EAU19651

## Panel C

### To remove the panel

1. Remove the seat. (See page 3-13.)
2. Remove the bolt, and then pull the panel off as shown.

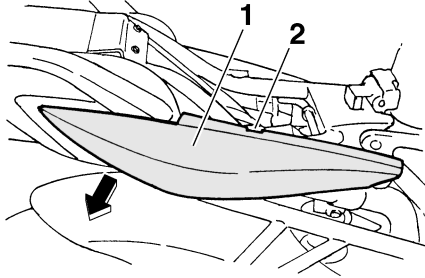

1. Panel C
2. Bolt

### To install the panel

1. Place the panel in the original position, and then install the bolt.

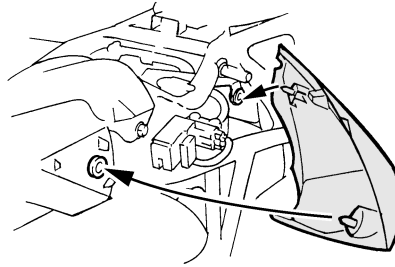

2. Install the seat.

## Checking the spark plugs

The spark plugs are important engine components, which should be checked periodically, preferably by a Yamaha dealer. Since heat and deposits will cause any spark plug to slowly erode, they should be removed and checked in accordance with the periodic maintenance and lubrication chart. In addition, the condition of the spark plugs can reveal the condition of the engine.

The porcelain insulator around the center electrode of each spark plug should be a medium-to-light tan (the ideal color when the vehicle is ridden normally), and all spark plugs installed in the engine should have the same color. If any spark plug shows a distinctly different color, the engine could be defective. Do not attempt to diagnose such problems yourself. Instead, have a Yamaha dealer check the vehicle.

If a spark plug shows signs of electrode erosion and excessive carbon or other deposits, it should be replaced.

**Specified spark plug:**  
NGK/CR9EK

# PERIODIC MAINTENANCE AND MINOR REPAIR

EAU32852

Before installing a spark plug, the spark plug gap should be measured with a wire thickness gauge and, if necessary, adjusted to specification.

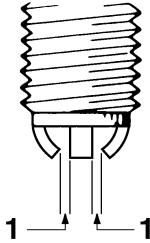

1. Spark plug gap

## Spark plug gap:

0.6–0.7 mm (0.024–0.028 in)

Clean the surface of the spark plug gasket and its mating surface, and then wipe off any grime from the spark plug threads.

## Tightening torque:

Spark plug:

17.5 Nm (1.75 m·kgf, 12.7 ft·lbf)

## NOTE: \_\_\_\_\_

If a torque wrench is not available when installing a spark plug, a good estimate of the correct torque is 1/4–1/2 turn past finger tight. However, the spark plug should be tightened to the specified torque as soon as possible.

ECA10840

## CAUTION: \_\_\_\_\_

**Do not use any tools to remove or install the spark plug cap, otherwise the ignition coil coupler may get damaged. The spark plug cap may be difficult to remove because the rubber seal on the end of the cap fits tightly. To remove the spark plug cap, simply twist it back and forth while pulling it out; to install it, twist it back and forth while pushing it in.**

## Engine oil and oil filter cartridge

The engine oil level should be checked before each ride. In addition, the oil must be changed and the oil filter cartridge replaced at the intervals specified in the periodic maintenance and lubrication chart.

## To check the engine oil level

1. Place the vehicle on a level surface and hold it in an upright position.

## NOTE: \_\_\_\_\_

Make sure that the vehicle is positioned straight up when checking the oil level. A slight tilt to the side can result in a false reading.

2. Start the engine, warm it up for several minutes, and then turn it off.
3. Wait a few minutes until the oil settles.

# PERIODIC MAINTENANCE AND MINOR REPAIR

4. Remove the engine oil dipstick and wipe it clean, insert it back into the hole (without screwing it in), and then remove it again to check the oil level.

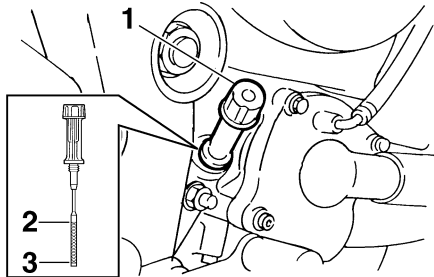

1. Dipstick
2. Maximum level mark
3. Minimum level mark

**NOTE:** \_\_\_\_\_  
The engine oil should be between the minimum and maximum level marks.

5. If the engine oil is at or below the minimum level mark, remove the oil filler cap, and then add sufficient oil of the recommended type to raise it to the correct level.

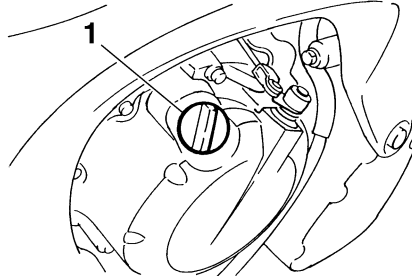

1. Engine oil filler cap

6. Insert and tighten the engine oil dipstick, and then install and tighten the oil filler cap.

## To change the engine oil (with or without oil filter cartridge replacement)

1. Start the engine, warm it up for several minutes, and then turn it off.
2. Place an oil pan under the engine to collect the used oil.
3. Remove the engine oil filler cap and drain bolt to drain the oil from the crankcase.

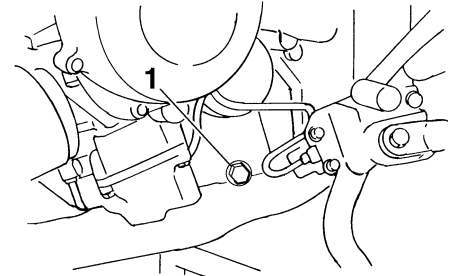

1. Engine oil drain bolt

**NOTE:** \_\_\_\_\_  
Skip steps 4–6 if the oil filter cartridge is not being replaced.

4. Remove the oil filter cartridge with an oil filter wrench.

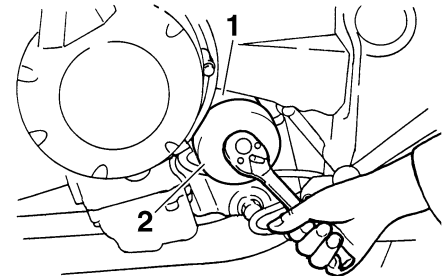

1. Engine oil filter cartridge
2. Oil filter wrench

# PERIODIC MAINTENANCE AND MINOR REPAIR

**NOTE:** \_\_\_\_\_  
An oil filter wrench is available at a Yamaha dealer.

5. Apply a thin coat of engine oil to the O-ring of the new oil filter cartridge.

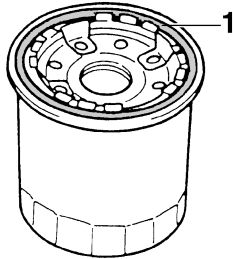

1. O-ring

**NOTE:** \_\_\_\_\_  
Make sure that the O-ring is properly seated.

6. Install the new oil filter cartridge with an oil filter wrench, and then tighten it to the specified torque with a torque wrench.

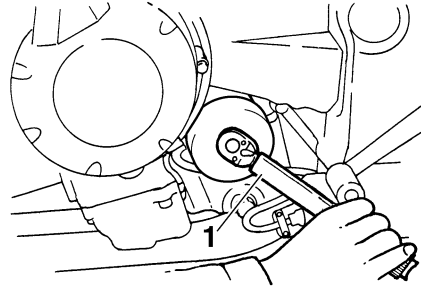

1. Torque wrench

**Tightening torque:**  
Oil filter cartridge:  
17 Nm (1.7 m·kgf, 12 ft·lbf)

7. Install the engine oil drain bolt, and then tighten it to the specified torque.

**NOTE:** \_\_\_\_\_  
Check the washer for damage and replace it if necessary.

**Tightening torque:**  
Engine oil drain bolt:  
43 Nm (4.3 m·kgf, 31 ft·lbf)

8. Add the specified amount of the recommended engine oil, and then install and tighten the oil filler cap.

## Recommended engine oil:

See page 8-1.

## Oil quantity:

Without oil filter cartridge replacement:

2.50 L (2.64 US qt) (2.20 Imp.qt)

With oil filter cartridge replacement:

2.80 L (2.96 US qt) (2.46 Imp.qt)

ECA11620

## CAUTION:

- In order to prevent clutch slippage (since the engine oil also lubricates the clutch), do not mix any chemical additives. Do not use oils with a diesel specification of “CD” or oils of a higher quality than specified. In addition, do not use oils labeled “ENERGY CONSERVING II” or higher.
- Make sure that no foreign material enters the crankcase.

9. Start the engine, and then let it idle for several minutes while checking it for oil leakage. If oil is leaking, immediately turn the engine off and check for the cause.

# PERIODIC MAINTENANCE AND MINOR REPAIR

**NOTE:** \_\_\_\_\_

After the engine is started, the engine oil level warning light should go off if the oil level is sufficient.

ECA10400

**CAUTION:** \_\_\_\_\_

**If the oil level warning light flickers or remains on, immediately turn the engine off and have a Yamaha dealer check the vehicle.**

10. Turn the engine off, and then check the oil level and correct it if necessary.

6

## Coolant

EAU20070

The coolant level should be checked before each ride. In addition, the coolant must be changed at the intervals specified in the periodic maintenance and lubrication chart.

EAU34352

### To check the coolant level

1. Place the vehicle on a level surface and hold it in an upright position.

**NOTE:** \_\_\_\_\_

- The coolant level must be checked on a cold engine since the level varies with engine temperature.
- Make sure that the vehicle is positioned straight up when checking the coolant level. A slight tilt to the side can result in a false reading.

2. Check the coolant level in the coolant reservoir.

**NOTE:** \_\_\_\_\_

The coolant should be between the minimum and maximum level marks.

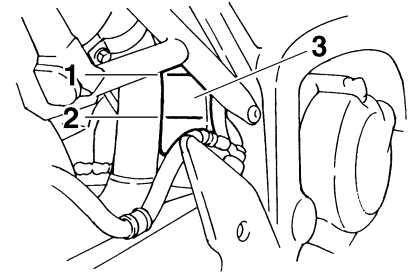

1. Maximum level mark
2. Minimum level mark
3. Coolant reservoir

3. If the coolant is at or below the minimum level mark, remove the seat. (See page 3-13.)
4. Remove the fuel tank bolts, and then lift the fuel tank away from the coolant reservoir cap. (See page 6-12.)
5. Open the coolant reservoir cap.



# PERIODIC MAINTENANCE AND MINOR REPAIR

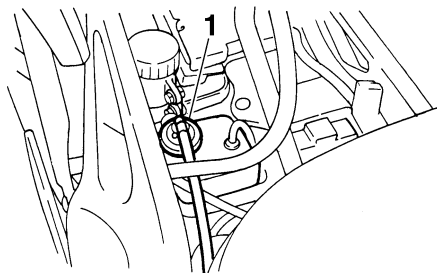

1. Coolant reservoir cap

6. Add coolant or distilled water to raise the coolant to the specified level, close the coolant reservoir cap, and then place the fuel tank in the original position and install the bolts.
7. Install the seat.

**Coolant reservoir capacity (up to the maximum level mark):**

0.27 L (0.29 US qt) (0.24 Imp.qt)

ECA10470

## CAUTION:

- If coolant is not available, use distilled water or soft tap water instead. Do not use hard water or salt water since it is harmful to the engine.

- If water has been used instead of coolant, replace it with coolant as soon as possible, otherwise the engine may not be sufficiently cooled and the cooling system will not be protected against frost and corrosion.
- If water has been added to the coolant, have a Yamaha dealer check the antifreeze content of the coolant as soon as possible, otherwise the effectiveness of the coolant will be reduced.

## WARNING

Never attempt to remove the radiator cap when the engine is hot.

## NOTE:

- The radiator fan is automatically switched on or off according to the coolant temperature in the radiator.
- If the engine overheats, see page 6-37 for further instructions.

## Changing the coolant

EAU33030

## WARNING

Never attempt to remove the radiator cap when the engine is hot.

EWA10380

The coolant must be changed at the intervals specified in the periodic maintenance and lubrication chart. Have a Yamaha dealer change the coolant.

EWA10380

## WARNING

Never attempt to remove the radiator cap when the engine is hot.

## NOTE:

- The radiator fan is automatically switched on or off according to the coolant temperature in the radiator.
- If the engine overheats, see page 6-37 for further instructions.

# PERIODIC MAINTENANCE AND MINOR REPAIR

EAU32885

## Replacing the air filter element

The air filter element should be replaced at the intervals specified in the periodic maintenance and lubrication chart. Replace the air filter element more frequently if you are riding in unusually wet or dusty areas.

1. Remove the seat. (See page 3-13.)
2. Remove panels A and B. (See page 6-5.)
3. Remove the fuel tank bolts, and then lift the fuel tank away from the air filter case.

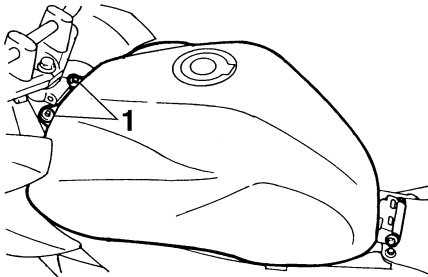

1. Bolt

4. Remove the air filter case cover by removing the screws.

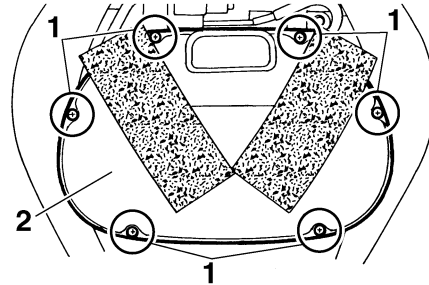

1. Screw
2. Air filter case cover

5. Pull the air filter element out.

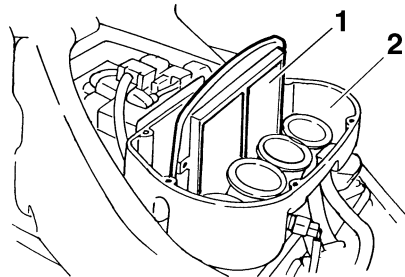

1. Air filter element
2. Air filter case

6. Insert a new air filter element into the air filter case.

ECA10480

## CAUTION:

- Make sure that the air filter element is properly seated in the air filter case.
- The engine should never be operated without the air filter element installed, otherwise the piston(s) and/or cylinder(s) may become excessively worn.

7. Install the air filter case cover by installing the screws.
8. Place the fuel tank in the original position and install the bolts.

EWA12462

## ! WARNING

- Before placing the fuel tank in the original position, make sure that all hoses (i.e., fuel hose, fuel tank breather hose, fuel tank overflow hose) are not damaged, that they are properly connected and routed, and that they are not pinched.
- If any hose is damaged, have a Yamaha dealer replace the hose before starting the engine, otherwise fuel may leak.

# PERIODIC MAINTENANCE AND MINOR REPAIR

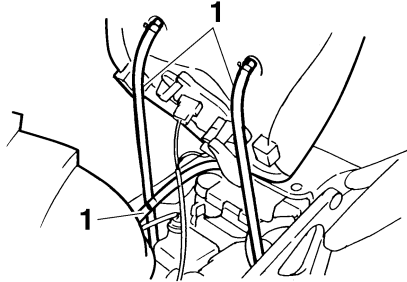

1. Hose

EWA12471

## WARNING

Be sure to place the hoses in their original position as shown.

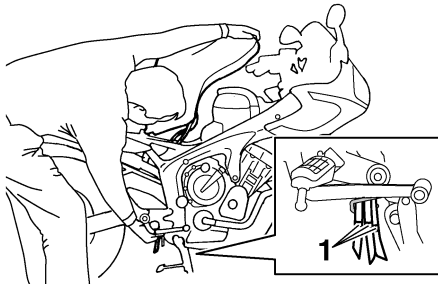

1. Original position (white mark)

9. Install the panels.
10. Install the seat.

EAU34300

## Adjusting the engine idling speed

The engine idling speed must be checked and, if necessary, adjusted as follows at the intervals specified in the periodic maintenance and lubrication chart.

The engine should be warm before making this adjustment.

### NOTE:

The engine is warm when it quickly responds to the throttle.

Check the engine idling speed and, if necessary, adjust it to specification by turning the idle adjusting screw. To increase the engine idling speed, turn the screw in direction (a). To decrease the engine idling speed, turn the screw in direction (b).

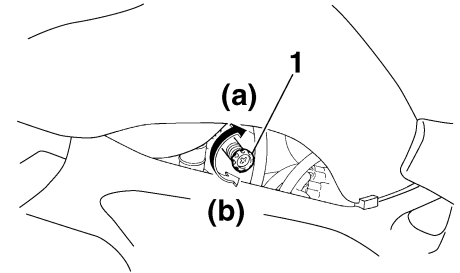

1. Idle adjusting screw

**Engine idling speed:**  
1250–1350 r/min

### NOTE:

If the specified idling speed cannot be obtained as described above, have a Yamaha dealer make the adjustment.

# PERIODIC MAINTENANCE AND MINOR REPAIR

## Checking the throttle cable free play

EAU21381

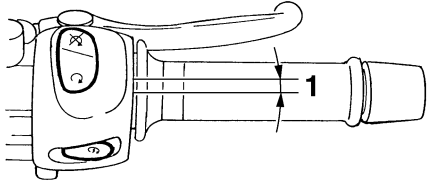

### 1. Throttle cable free play

The throttle cable free play should measure 3.0–5.0 mm (0.12–0.20 in) at the throttle grip. Periodically check the throttle cable free play and, if necessary, have a Yamaha dealer adjust it.

6

## Valve clearance

EAU21401

The valve clearance changes with use, resulting in improper air-fuel mixture and/or engine noise. To prevent this from occurring, the valve clearance must be adjusted by a Yamaha dealer at the intervals specified in the periodic maintenance and lubrication chart.

## Tires

EAU21771

To maximize the performance, durability, and safe operation of your motorcycle, note the following points regarding the specified tires.

### Tire air pressure

The tire air pressure should be checked and, if necessary, adjusted before each ride.

EWA10500

### **⚠ WARNING**

- The tire air pressure must be checked and adjusted on cold tires (i.e., when the temperature of the tires equals the ambient temperature).
- The tire air pressure must be adjusted in accordance with the riding speed and with the total weight of rider, passenger, cargo, and accessories approved for this model.

# PERIODIC MAINTENANCE AND MINOR REPAIR

**Tire air pressure (measured on cold tires):**

**0–90 kg (0–198 lb):**

Front:

225 kPa (33 psi) (2.25 kgf/cm<sup>2</sup>)

Rear:

250 kPa (36 psi) (2.50 kgf/cm<sup>2</sup>)

**90–190 kg (198–419 lb):**

Front:

250 kPa (36 psi) (2.50 kgf/cm<sup>2</sup>)

Rear:

290 kPa (42 psi) (2.90 kgf/cm<sup>2</sup>)

**High-speed riding:**

Front:

225 kPa (33 psi) (2.25 kgf/cm<sup>2</sup>)

Rear:

250 kPa (36 psi) (2.50 kgf/cm<sup>2</sup>)

**Maximum load\*:**

190 kg (419 lb)

\* Total weight of rider, passenger, cargo and accessories

EWA11020

## **WARNING**

Because loading has an enormous impact on the handling, braking, performance and safety characteristics of your motorcycle, you should keep the following precautions in mind.

- **NEVER OVERLOAD THE MOTORCYCLE!** Operation of an overloaded motorcycle may result in tire damage, loss of control, or severe injury. Make sure that the total weight of rider, passenger, cargo, and accessories does not exceed the specified maximum load for the vehicle.
- **Do not carry along loosely packed items, which can shift during a ride.**
- **Securely pack the heaviest items close to the center of the motorcycle and distribute the weight evenly on both sides.**
- **Adjust the suspension and tire air pressure with regard to the load.**
- **Check the tire condition and air pressure before each ride.**

## Tire inspection

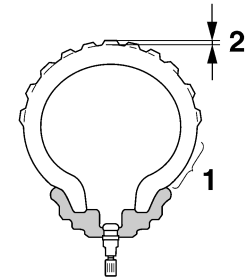

1. Tire sidewall
2. Tire tread depth

The tires must be checked before each ride. If the center tread depth reaches the specified limit, if the tire has a nail or glass fragments in it, or if the sidewall is cracked, have a Yamaha dealer replace the tire immediately.

**Minimum tire tread depth (front and rear):**

1.6 mm (0.06 in)

**NOTE:** \_\_\_\_\_

The tire tread depth limits may differ from country to country. Always comply with the local regulations.

# PERIODIC MAINTENANCE AND MINOR REPAIR

EWA10470

## **WARNING**

- Have a Yamaha dealer replace excessively worn tires. Besides being illegal, operating the vehicle with excessively worn tires decreases riding stability and can lead to loss of control.
- The replacement of all wheel and brake related parts, including the tires, should be left to a Yamaha dealer, who has the necessary professional knowledge and experience.

6

## Tire information

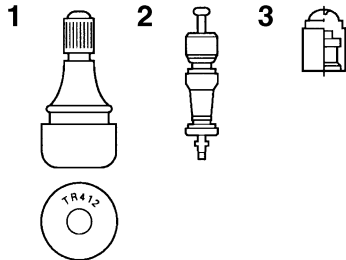

1. Tire air valve
2. Tire air valve core
3. Tire air valve cap with seal

This motorcycle is equipped with cast wheels and tubeless tires with valves.

EWA10480

## **WARNING**

- The front and rear tires should be of the same make and design, otherwise the handling characteristics of the motorcycle cannot be guaranteed.
- After extensive tests, only the tires listed below have been approved for this model by Yamaha Motor Co., Ltd.
- Always make sure that the valve caps are securely installed to prevent air pressure leakage.
- Use only the tire valves and valve cores listed below to avoid tire deflation during a high-speed ride.

### Front tire:

Size:

120/70 ZR17M/C (58W)

Manufacturer/model:

BRIDGESTONE/BT020F GG  
DUNLOP/D252F

### Rear tire:

Size:

180/55 ZR17M/C (73W)

Manufacturer/model:

BRIDGESTONE/BT020R GG  
DUNLOP/D252

### FRONT and REAR:

Tire air valve:

TR412

Valve core:

#9100

EWA10600

## **WARNING**

This motorcycle is fitted with super-high-speed tires. Note the following points in order to make the most efficient use of these tires.

- Use only the specified replacement tires. Other tires may run the danger of bursting at super high speeds.
- Brand-new tires can have a relatively poor grip on certain road surfaces until they have been

“broken in”. Therefore, it is advisable before doing any high-speed riding to ride conservatively for approximately 100 km (60 mi) after installing a new tire.

- The tires must be warmed up before a high-speed run.
- Always adjust the tire air pressure according to the operating conditions.

## Cast wheels

To maximize the performance, durability, and safe operation of your vehicle, note the following points regarding the specified wheels.

- The wheel rims should be checked for cracks, bends or warpage before each ride. If any damage is found, have a Yamaha dealer replace the wheel. Do not attempt even the smallest repair to the wheel. A deformed or cracked wheel must be replaced.
- The wheel should be balanced whenever either the tire or wheel has been changed or replaced. An unbalanced wheel can result in poor performance, adverse handling characteristics, and a shortened tire life.
- Ride at moderate speeds after changing a tire since the tire surface must first be “broken in” for it to develop its optimal characteristics.

EAU21960

## Adjusting the clutch lever free play

EAU22080

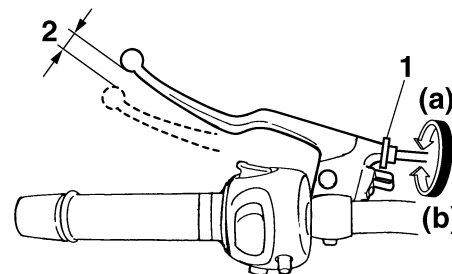

1. Clutch lever free play adjusting bolt
2. Clutch lever free play

The clutch lever free play should measure 10.0–15.0 mm (0.39–0.59 in) as shown. Periodically check the clutch lever free play and, if necessary, adjust it as follows.

To increase the clutch lever free play, turn the adjusting bolt in direction (a). To decrease the clutch lever free play, turn the adjusting bolt in direction (b).

# PERIODIC MAINTENANCE AND MINOR REPAIR

## NOTE: \_\_\_\_\_

If the specified free play cannot be obtained as described above or if the clutch does not operate correctly, have a Yamaha dealer check the internal clutch mechanism.

## Adjusting the rear brake light switch

EAU36500

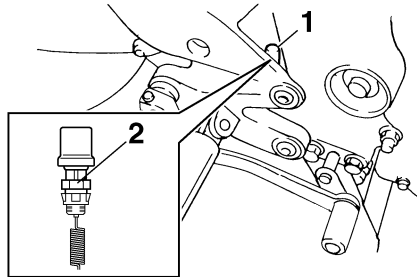

1. Rear brake light switch
2. Rear brake light switch adjusting nut

The rear brake light switch, which is activated by the brake pedal, is properly adjusted when the brake light comes on just before braking takes effect. If necessary, have a Yamaha dealer adjust the brake light switch.

## Checking the front and rear brake pads

EAU22390

The front and rear brake pads must be checked for wear at the intervals specified in the periodic maintenance and lubrication chart.

### Front brake pads

EAU22420

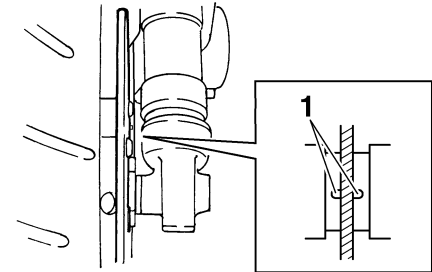

1. Brake pad wear indicator groove

Each front brake pad is provided with a wear indicator groove, which allows you to check the brake pad wear without having to disassemble the brake. To check the brake pad wear, check the wear indicator groove. If a brake pad has worn to the point that the wear



# PERIODIC MAINTENANCE AND MINOR REPAIR

indicator groove has almost disappeared, have a Yamaha dealer replace the brake pads as a set.

## Rear brake pads

EAU22500

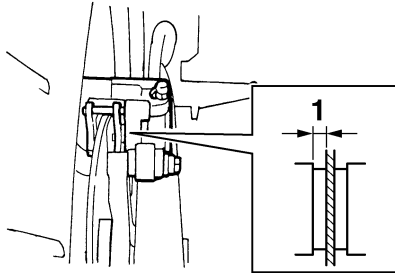

1. Lining thickness

Check each rear brake pad for damage and measure the lining thickness. If a brake pad is damaged or if the lining thickness is less than 1.0 mm (0.04 in), have a Yamaha dealer replace the brake pads as a set.

## Checking the brake fluid level

EAU36470

### Front brake

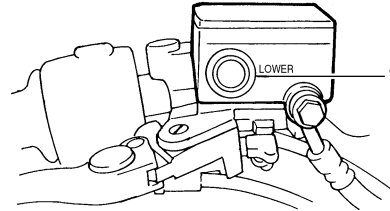

1. Minimum level mark

### Rear brake

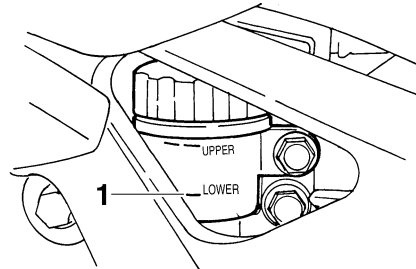

1. Minimum level mark

Insufficient brake fluid may allow air to enter the brake system, possibly causing it to become ineffective.

Before riding, check that the brake fluid is above the minimum level mark and replenish if necessary. A low brake fluid level may indicate worn brake pads and/or brake system leakage. If the brake fluid level is low, be sure to check the brake pads for wear and the brake system for leakage.

### NOTE:

The rear brake fluid reservoir is located under the fuel tank. (See page 6-12.)

Observe these precautions:

- When checking the fluid level, make sure that the top of the brake fluid reservoir is level.
- Use only the recommended quality brake fluid, otherwise the rubber seals may deteriorate, causing leakage and poor braking performance.

**Recommended brake fluid:**  
DOT 4

- Refill with the same type of brake fluid. Mixing fluids may result in a harmful chemical reaction and lead to poor braking performance.

# PERIODIC MAINTENANCE AND MINOR REPAIR

- Be careful that water does not enter the brake fluid reservoir when refilling. Water will significantly lower the boiling point of the fluid and may result in vapor lock.
- Brake fluid may deteriorate painted surfaces or plastic parts. Always clean up spilled fluid immediately.
- As the brake pads wear, it is normal for the brake fluid level to gradually go down. However, if the brake fluid level goes down suddenly, have a Yamaha dealer check the cause.

## Changing the brake fluid

EAU22730

Have a Yamaha dealer change the brake fluid at the intervals specified in the NOTE after the periodic maintenance and lubrication chart. In addition, have the oil seals of the master cylinders and calipers as well as the brake hoses replaced at the intervals listed below or whenever they are damaged or leaking.

- Oil seals: Replace every two years.
- Brake hoses: Replace every four years.

## Drive chain slack

EAU22760

The drive chain slack should be checked before each ride and adjusted if necessary.

### To check the drive chain slack

EAU22791

1. Place the motorcycle on the centerstand.
2. Shift the transmission into the neutral position.
3. Spin the rear wheel several times to locate the tightest portion of the drive chain.
4. Measure the drive chain slack as shown.

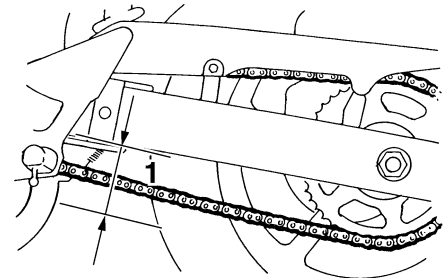

1. Drive chain slack

# PERIODIC MAINTENANCE AND MINOR REPAIR

## Drive chain slack:

45.0–55.0 mm (1.77–2.17 in)

5. If the drive chain slack is incorrect, adjust it as follows.

## To adjust the drive chain slack

EAU34361

1. Loosen the axle nut, then loosen the locknut at each end of the swingarm.
2. To tighten the drive chain, turn the adjusting nut at each end of the swingarm in direction (a). To loosen the drive chain, turn the adjusting nut at each end of the swingarm in direction (b), and then push the rear wheel forward.

## NOTE:

Using the alignment marks on each side of the swingarm, make sure that both adjusting nuts are in the same position for proper wheel alignment.

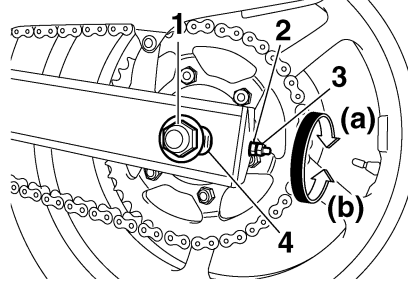

1. Axle nut
2. Drive chain slack adjusting nut
3. Locknut
4. Alignment marks

ECA10570

## CAUTION:

**Improper drive chain slack will overload the engine as well as other vital parts of the motorcycle and can lead to chain slippage or breakage. To prevent this from occurring, keep the drive chain slack within the specified limits.**

3. Tighten the locknuts, and then tighten the axle nut to the specified torque.

## Tightening torques:

Locknut:

16 Nm (1.6 m·kgf, 11 ft·lbf)

Axle nut:

120 Nm (12.0 m·kgf, 85 ft·lbf)

# PERIODIC MAINTENANCE AND MINOR REPAIR

## Cleaning and lubricating the drive chain

EAU23022

The drive chain must be cleaned and lubricated at the intervals specified in the periodic maintenance and lubrication chart, otherwise it will quickly wear out, especially when riding in dusty or wet areas. Service the drive chain as follows.

ECA10581

### CAUTION:

**The drive chain must be lubricated after washing the motorcycle and riding in the rain.**

1. Clean the drive chain with kerosene and a small soft brush.

ECA11120

### CAUTION:

**To prevent damaging the O-rings, do not clean the drive chain with steam cleaners, high-pressure washers or inappropriate solvents.**

2. Wipe the drive chain dry.
3. Thoroughly lubricate the drive chain with a special O-ring chain lubricant.

ECA11110

### CAUTION:

**Do not use engine oil or any other lubricants for the drive chain, as they may contain substances that could damage the O-rings.**

EAU23100

## Checking and lubricating the cables

The operation of all control cables and the condition of the cables should be checked before each ride, and the cables and cable ends should be lubricated if necessary. If a cable is damaged or does not move smoothly, have a Yamaha dealer check or replace it.

**Recommended lubricant:**  
Engine oil

EWA10720

### WARNING

**Damage to the outer sheath may interfere with proper cable operation and will cause the inner cable to rust. Replace a damaged cable as soon as possible to prevent unsafe conditions.**

# PERIODIC MAINTENANCE AND MINOR REPAIR

## Checking and lubricating the throttle grip and cable

EAU23111

The operation of the throttle grip should be checked before each ride. In addition, the cable should be lubricated at the intervals specified in the periodic maintenance chart.

## Checking and lubricating the brake and shift pedals

EAU23131

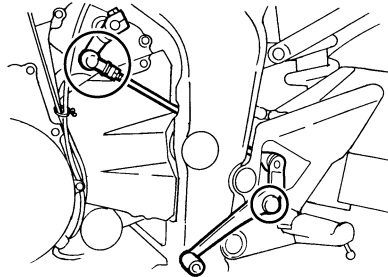
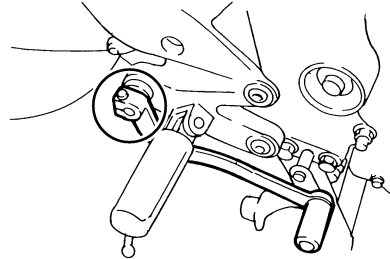

**Recommended lubricant:**  
Lithium-soap-based grease (all-purpose grease)

The operation of the brake and shift pedals should be checked before each ride, and the pedal pivots should be lubricated if necessary.

# PERIODIC MAINTENANCE AND MINOR REPAIR

## Checking and lubricating the brake and clutch levers

EAU23140

### Brake lever

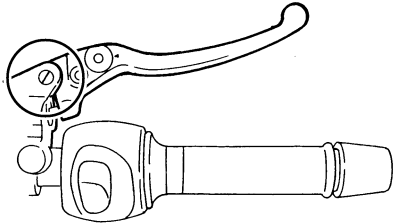

### Clutch lever

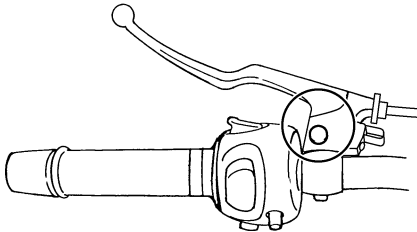

The operation of the brake and clutch levers should be checked before each ride, and the lever pivots should be lubricated if necessary.

**Recommended lubricant:**  
Lithium-soap-based grease (all-purpose grease)

## Checking and lubricating the centerstand and sidestand

EAU23211

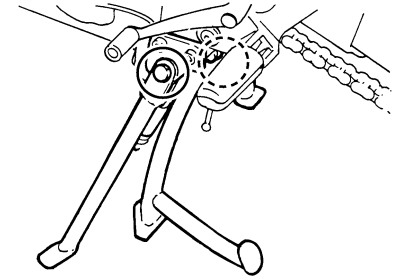

The operation of the centerstand and sidestand should be checked before each ride, and the pivots and metal-to-metal contact surfaces should be lubricated if necessary.

### **! WARNING**

If the centerstand or sidestand does not move up and down smoothly, have a Yamaha dealer check or repair it.

EWA10740

**Recommended lubricant:**  
Lithium-soap-based grease (all-purpose grease)

# PERIODIC MAINTENANCE AND MINOR REPAIR

## Lubricating the swingarm pivots

EAM1650

The swingarm pivots must be lubricated at the intervals specified in the periodic maintenance and lubrication chart.

**Recommended lubricant:**  
Lithium-soap-based grease

## Checking the front fork

EAU23271

The condition and operation of the front fork must be checked as follows at the intervals specified in the periodic maintenance and lubrication chart.

### To check the condition

EWA10750

#### **WARNING**

**Securely support the vehicle so that there is no danger of it falling over.**

Check the inner tubes for scratches, damage and excessive oil leakage.

### To check the operation

1. Place the vehicle on a level surface and hold it in an upright position.
2. While applying the front brake, push down hard on the handlebars several times to check if the front fork compresses and rebounds smoothly.

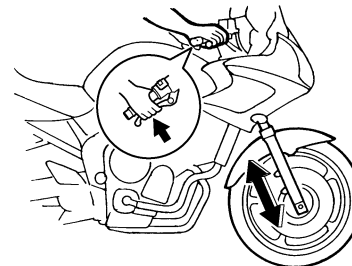

ECA10590

#### **CAUTION:**

**If any damage is found or the front fork does not operate smoothly, have a Yamaha dealer check or repair it.**

# PERIODIC MAINTENANCE AND MINOR REPAIR

EAU23280

## Checking the steering

Worn or loose steering bearings may cause danger. Therefore, the operation of the steering must be checked as follows at the intervals specified in the periodic maintenance and lubrication chart.

1. Place a stand under the engine to raise the front wheel off the ground.

EWA10750

### **WARNING**

**Securely support the vehicle so that there is no danger of it falling over.**

2. Hold the lower ends of the front fork legs and try to move them forward and backward. If any free play can be felt, have a Yamaha dealer check or repair the steering.

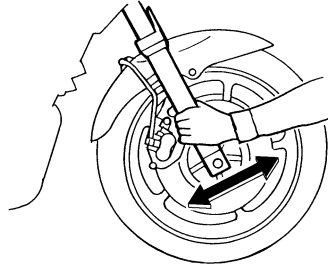

EAU23290

## Checking the wheel bearings

The front and rear wheel bearings must be checked at the intervals specified in the periodic maintenance and lubrication chart. If there is play in the wheel hub or if the wheel does not turn smoothly, have a Yamaha dealer check the wheel bearings.



# PERIODIC MAINTENANCE AND MINOR REPAIR

## Battery

EAU34371

EWA10760

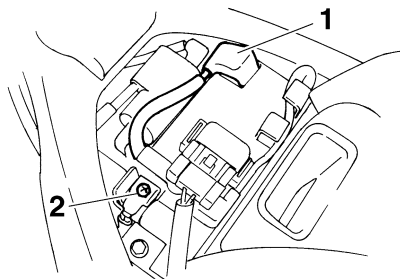

1. Positive battery terminal
2. Negative battery terminal

The battery is located under the fuel tank. (See page 6-12.)

This model is equipped with a sealed-type (MF) battery, which does not require any maintenance. There is no need to check the electrolyte or to add distilled water.

### To charge the battery

Have a Yamaha dealer charge the battery as soon as possible if it seems to have discharged. Keep in mind that the battery tends to discharge more quickly if the vehicle is equipped with optional electrical accessories.

### **!** WARNING

- **Electrolyte is poisonous and dangerous since it contains sulfuric acid, which causes severe burns. Avoid any contact with skin, eyes or clothing and always shield your eyes when working near batteries. In case of contact, administer the following FIRST AID.**
  - **EXTERNAL:** Flush with plenty of water.
  - **INTERNAL:** Drink large quantities of water or milk and immediately call a physician.
  - **EYES:** Flush with water for 15 minutes and seek prompt medical attention.
- **Batteries produce explosive hydrogen gas. Therefore, keep sparks, flames, cigarettes, etc., away from the battery and provide sufficient ventilation when charging it in an enclosed space.**

- **KEEP THIS AND ALL BATTERIES OUT OF THE REACH OF CHILDREN.**

### To store the battery

1. If the vehicle will not be used for more than one month, remove the battery, fully charge it, and then place it in a cool, dry place.
2. If the battery will be stored for more than two months, check it at least once a month and fully charge it if necessary.
3. Fully charge the battery before installation.
4. After installation, make sure that the battery leads are properly connected to the battery terminals.

ECA10630

### **CAUTION:**

- **Always keep the battery charged. Storing a discharged battery can cause permanent battery damage.**
- **To charge a sealed-type (MF) battery, a special (constant-voltage) battery charger is required. Using a conventional battery**

# PERIODIC MAINTENANCE AND MINOR REPAIR

charger will damage the battery. If you do not have access to a sealed-type (MF) battery charger, have a Yamaha dealer charge your battery.

## Replacing the fuses

EAU32842

The main fuse is located under the fuel tank. (See page 6-12.)

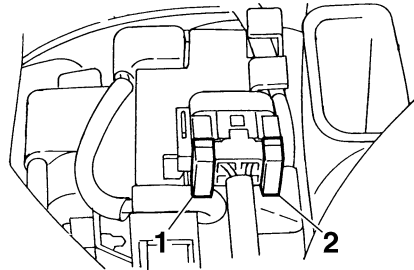

1. Main fuse
2. Spare fuse

The fuse box is located behind panel C. (See page 6-5.)

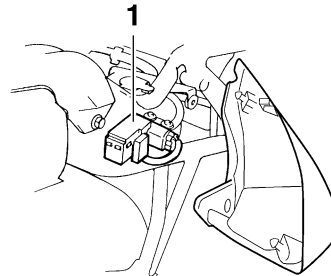

1. Fuse box

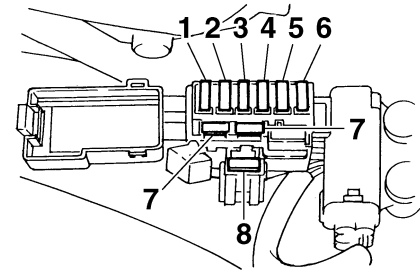

1. Headlight fuse
2. Signaling system fuse
3. Ignition fuse
4. Radiator fan fuse
5. Backup fuse (for odometer, clock and immobilizer system)
6. Fuel injection system fuse
7. Spare fuse
8. Parking lighting fuse

If a fuse is blown, replace it as follows.

1. Turn the key to "OFF" and turn off the electrical circuit in question.
2. Remove the blown fuse, and then install a new fuse of the specified amperage.

# PERIODIC MAINTENANCE AND MINOR REPAIR

## Specified fuses:

- Main fuse:  
30.0 A
- Headlight fuse:  
20.0 A
- Signaling system fuse:  
10.0 A
- Ignition fuse:  
10.0 A
- Radiator fan fuse:  
20.0 A
- Fuel injection system fuse:  
10.0 A
- Backup fuse:  
10.0 A
- Parking lighting fuse:  
10.0 A

ECA10640

## CAUTION:

**Do not use a fuse of a higher amperage rating than recommended to avoid causing extensive damage to the electrical system and possibly a fire.**

3. Turn the key to "ON" and turn on the electrical circuit in question to check if the device operates.
4. If the fuse immediately blows again, have a Yamaha dealer check the electrical system.

## Replacing the headlight bulb

EAU23740

This model is equipped with a quartz bulb headlight. If the headlight bulb burns out, replace it as follows.

1. Disconnect the headlight coupler, and then remove the bulb cover.

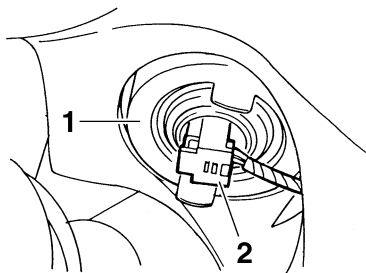

1. Headlight bulb cover
2. Headlight coupler

2. Unhook the headlight bulb holder, and then remove the defective bulb.

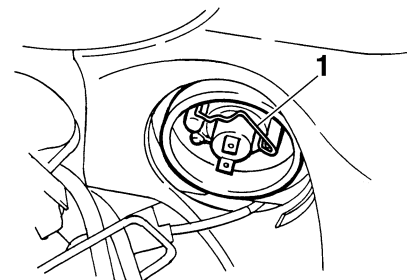

1. Headlight bulb holder

EWA10790

## WARNING

**Headlight bulbs get very hot. Therefore, keep flammable products away from a lit headlight bulb, and do not touch the bulb until it has cooled down.**

3. Place a new headlight bulb into position, and then secure it with the bulb holder.

ECA10650

## CAUTION:

**Take care not to damage the following parts:**

# PERIODIC MAINTENANCE AND MINOR REPAIR

- **Headlight bulb**

Do not touch the glass part of the headlight bulb to keep it free from oil, otherwise the transparency of the glass, the luminosity of the bulb, and the bulb life will be adversely affected. Thoroughly clean off any dirt and fingerprints on the headlight bulb using a cloth moistened with alcohol or thinner.

- **Headlight lens**

Do not affix any type of tinted film or stickers to the headlight lens.

Do not use a headlight bulb of a wattage higher than specified.

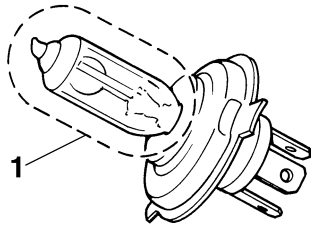

1. Do not touch the glass part of the bulb.

4. Install the headlight bulb cover, and then connect the coupler.
5. Have a Yamaha dealer adjust the headlight beam if necessary.

## Replacing the tail/brake light bulb

EAU32822

1. Remove the seat. (See page 3-13.)
2. Remove the socket (together with the bulb) by turning it counter-clockwise.

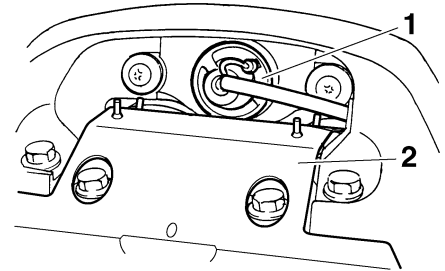

1. Tail/brake light bulb socket
2. Muffler bracket cover

### **⚠ WARNING**

EWA12301

**Do not touch the muffler bracket until the exhaust system has cooled.**

3. Remove the defective bulb by pushing it in and turning it counter-clockwise.

# PERIODIC MAINTENANCE AND MINOR REPAIR

4. Insert a new bulb into the socket, push it in, and then turn it clockwise until it stops.
5. Install the socket (together with the bulb) by turning it clockwise.
6. Install the seat.

## Replacing a turn signal light bulb

EAU24202

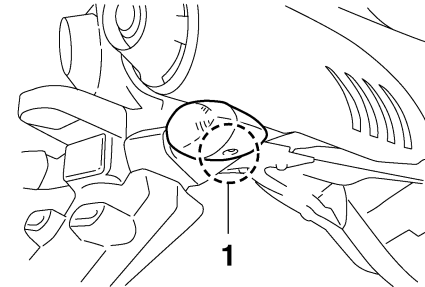

1. Screw

2. Remove the defective bulb by pushing it in and turning it counter-clockwise.
3. Insert a new bulb into the socket, push it in, and then turn it clockwise until it stops.
4. Install the lens by installing the screw.

ECA11190

### CAUTION:

**Do not overtighten the screw, otherwise the lens may break.**

## Replacing the license plate light bulb

EAU24310

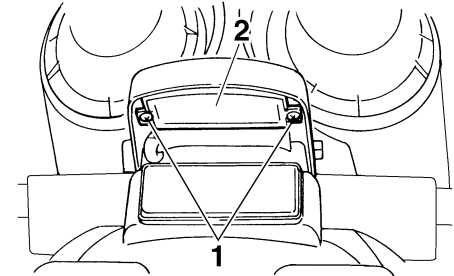

1. Screw
2. License plate light unit

2. Remove the socket (together with the bulb) by pulling it out.

# PERIODIC MAINTENANCE AND MINOR REPAIR

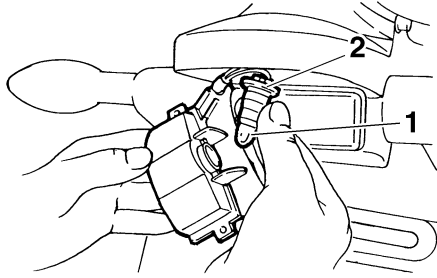

1. License plate light bulb
2. License plate light bulb socket

3. Remove the defective bulb by pulling it out.
4. Insert a new bulb into the socket.
5. Install the socket (together with the bulb) by pushing it in.
6. Install the license plate light unit by installing the screws.

6

## Replacing an auxiliary light bulb

EAU32830

This model is equipped with two auxiliary lights. If an auxiliary light bulb burns out, replace it as follows.

1. Remove panel B (if replacing the left auxiliary light bulb) or panel A (if replacing the right auxiliary light bulb). (See page 6-5.)
2. Remove the auxiliary light socket (together with the coupler) by pulling it out.

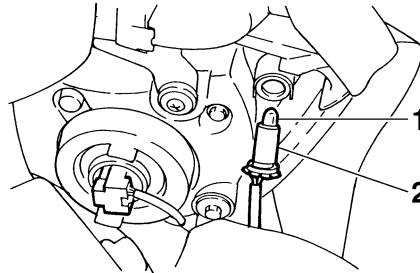

1. Auxiliary light bulb
2. Auxiliary light bulb socket

3. Remove the defective bulb by pulling it out.
4. Insert a new bulb into the socket.

5. Install the auxiliary light socket (together with the coupler) by pushing it in.

# PERIODIC MAINTENANCE AND MINOR REPAIR

## Front wheel

EAU24360

### To remove the front wheel

EAU24470

EWA10820

#### **WARNING**

- It is advisable to have a Yamaha dealer service the wheel.
- Securely support the motorcycle so that there is no danger of it falling over.

1. Place the motorcycle on the centerstand.
2. Loosen the front wheel axle pinch bolt, then the wheel axle and the brake caliper bolts.

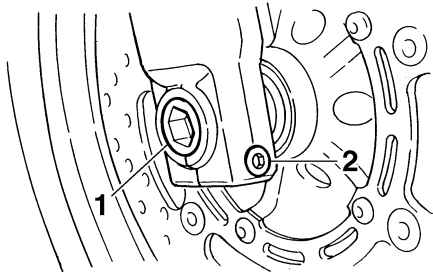

1. Wheel axle
2. Front wheel axle pinch bolt

3. Remove the brake hose holder on each side by removing the bolts.
4. Remove the brake caliper on each side by removing the bolts.

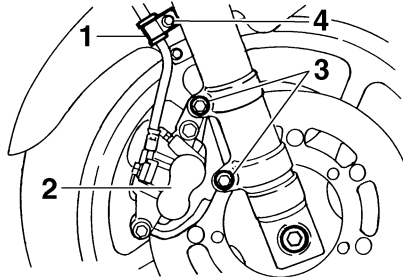

1. Brake hose holder
2. Brake caliper
3. Brake caliper bolt
4. Bolt

#### **CAUTION:**

**Do not apply the brake after the brake calipers have been removed, otherwise the brake pads will be forced shut.**

5. Pull the wheel axle out, and then remove the wheel.

### To install the front wheel

EAU33660

1. Lift the wheel up between the fork legs.
2. Insert the wheel axle.
3. Install the brake calipers by installing the bolts.

#### **NOTE:**

Make sure that there is enough space between the brake pads before installing the brake calipers onto the brake discs.

4. Install the brake hose holders by installing the bolts.
5. Take the motorcycle off the centerstand so that the front wheel is on the ground.
6. Tighten the wheel axle, the front wheel axle pinch bolt and the brake caliper bolts to the specified torques.

#### **Tightening torques:**

- Wheel axle:  
72 Nm (7.2 m·kgf, 52 ft·lbf)  
Front wheel axle pinch bolt:  
19 Nm (1.9 m·kgf, 13 ft·lbf)  
Brake caliper bolt:  
40 Nm (4.0 m·kgf, 29 ft·lbf)

# PERIODIC MAINTENANCE AND MINOR REPAIR

7. Push down hard on the handlebar several times to check for proper fork operation.

## Rear wheel

EAU25080

EAU32872

EWA10820

### To remove the rear wheel

#### **WARNING**

- It is advisable to have a Yamaha dealer service the wheel.
- Securely support the motorcycle so that there is no danger of it falling over.

1. Loosen the axle nut.
2. Place the motorcycle on the centerstand.
3. Remove the axle nut.
4. Loosen the locknut and drive chain adjusting nut on each side of the swingarm.

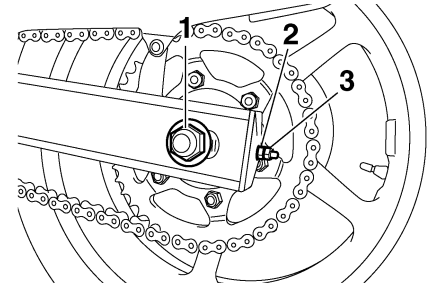

1. Axle nut
2. Drive chain slack adjusting nut
3. Locknut

5. Push the wheel forward, and then remove the drive chain from the rear sprocket.

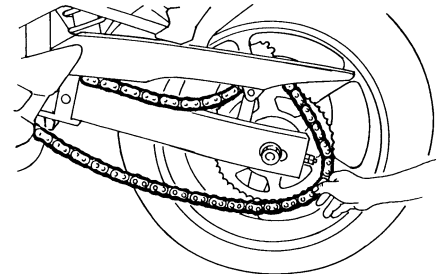



# PERIODIC MAINTENANCE AND MINOR REPAIR

**NOTE:** \_\_\_\_\_

The drive chain does not need to be disassembled in order to remove and install the rear wheel.

6. While supporting the brake caliper and slightly lifting the wheel, pull the wheel axle out.

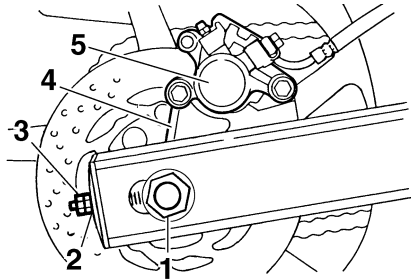

1. Wheel axle
2. Drive chain slack adjusting nut
3. Locknut
4. Brake caliper bracket
5. Brake caliper

**NOTE:** \_\_\_\_\_

A rubber mallet may be useful to tap the wheel axle out.

7. Remove the wheel.

ECA11070

**CAUTION:** \_\_\_\_\_

**Do not apply the brake after the wheel has been removed together with the brake disc, otherwise the brake pads will be forced shut.**

EAU32940

**To install the rear wheel**

1. Install the wheel and the brake caliper bracket by inserting the wheel axle from the right-hand side.

**NOTE:** \_\_\_\_\_

- Make sure that the retainer on the swingarm is inserted into the slot in the brake caliper bracket.
- Make sure that there is enough space between the brake pads before installing the wheel.

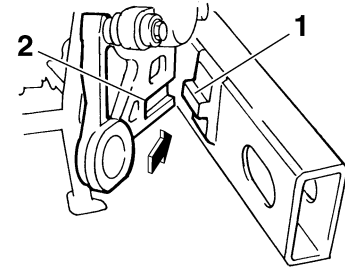

1. Retainer
2. Slot

2. Install the drive chain onto the rear sprocket, and then adjust the drive chain slack. (See page 6-20.)
3. Install the axle nut, and then lower the rear wheel so that it is on the ground.
4. Tighten the axle nut to the specified torque.

**Tightening torque:**

Axle nut:  
120 Nm (12.0 m·kgf, 85 ft·lbf)

# PERIODIC MAINTENANCE AND MINOR REPAIR

---

EAU25870

## Troubleshooting

Although Yamaha motorcycles receive a thorough inspection before shipment from the factory, trouble may occur during operation. Any problem in the fuel, compression, or ignition systems, for example, can cause poor starting and loss of power.

The following troubleshooting charts represent quick and easy procedures for checking these vital systems yourself. However, should your motorcycle require any repair, take it to a Yamaha dealer, whose skilled technicians have the necessary tools, experience, and know-how to service the motorcycle properly.

Use only genuine Yamaha replacement parts. Imitation parts may look like Yamaha parts, but they are often inferior, have a shorter service life and can lead to expensive repair bills.

# PERIODIC MAINTENANCE AND MINOR REPAIR

EAU25911

## Troubleshooting charts

### Starting problems or poor engine performance

EWA10840



**WARNING**

Keep away open flames and do not smoke while checking or working on the fuel system.

#### 1. Fuel

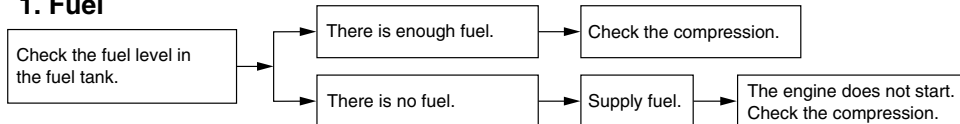

#### 2. Compression

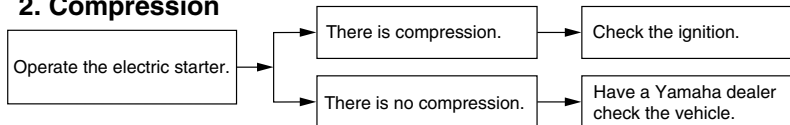

#### 3. Ignition

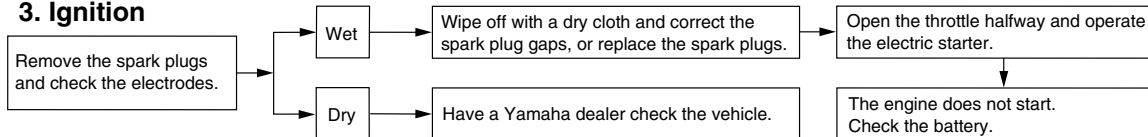

#### 4. Battery

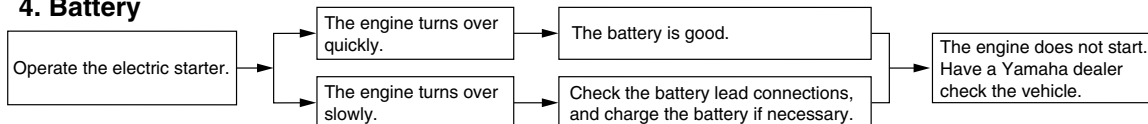

# PERIODIC MAINTENANCE AND MINOR REPAIR

## Engine overheating

EWA10400

### WARNING

- Do not remove the radiator cap when the engine and radiator are hot. Scalding hot fluid and steam may be blown out under pressure, which could cause serious injury. Be sure to wait until the engine has cooled.
- After removing the radiator cap retaining bolt, place a thick rag, like a towel, over the radiator cap, and then slowly rotate the cap counterclockwise to the detent to allow any residual pressure to escape. When the hissing sound has stopped, press down on the cap while turning it counterclockwise, and then remove the cap.

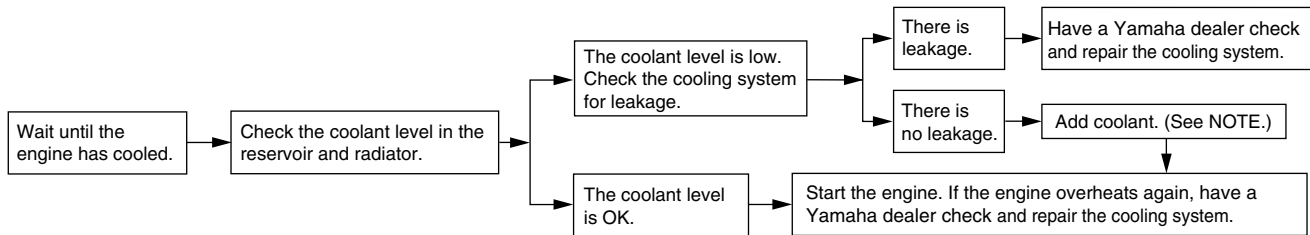

6

### NOTE:

If coolant is not available, tap water can be temporarily used instead, provided that it is changed to the recommended coolant as soon as possible.

## Care

EAU26040

While the open design of a motorcycle reveals the attractiveness of the technology, it also makes it more vulnerable. Rust and corrosion can develop even if high-quality components are used. A rusty exhaust pipe may go unnoticed on a car, however, it detracts from the overall appearance of a motorcycle. Frequent and proper care does not only comply with the terms of the warranty, but it will also keep your motorcycle looking good, extend its life and optimize its performance.

## Before cleaning

1. Cover the muffler outlets with plastic bags after the engine has cooled down.
2. Make sure that all caps and covers as well as all electrical couplers and connectors, including the spark plug caps, are tightly installed.
3. Remove extremely stubborn dirt, like oil burnt onto the crankcase, with a degreasing agent and a brush, but never apply such prod-

ucts onto seals, gaskets, sprockets, the drive chain and wheel axles. Always rinse the dirt and degreaser off with water.

## Cleaning

ECA10770

### CAUTION:

- **Avoid using strong acidic wheel cleaners, especially on spoked wheels. If such products are used on hard-to-remove dirt, do not leave the cleaner on the affected area any longer than instructed. Also, thoroughly rinse the area off with water, immediately dry it, and then apply a corrosion protection spray.**
- **Improper cleaning can damage windshields, cowlings, panels and other plastic parts. Use only a soft, clean cloth or sponge with mild detergent and water to clean plastic.**
- **Do not use any harsh chemical products on plastic parts. Be sure to avoid using cloths or sponges which have been in contact with strong or abrasive cleaning products, solvent or thinner, fuel (gasoline), rust removers or inhibitors, brake fluid, antifreeze or electrolyte.**
- **Do not use high-pressure washers or steam-jet cleaners since they cause water seepage and deterioration in the following areas: seals (of wheel and swing-arm bearings, fork and brakes), electric components (couplers, connectors, instruments, switches and lights), breather hoses and vents.**
- **For motorcycles equipped with a windshield: Do not use strong cleaners or hard sponges as they will cause dulling or scratching. Some cleaning compounds for plastic may leave scratches on the windshield. Test the product on a small hidden part of the windshield to make sure that it does not leave any marks. If the windshield is scratched, use a quality plastic polishing compound after washing.**

# MOTORCYCLE CARE AND STORAGE

---

## After normal use

Remove dirt with warm water, a mild detergent, and a soft, clean sponge, and then rinse thoroughly with clean water. Use a toothbrush or bottlebrush for hard-to-reach areas. Stubborn dirt and insects will come off more easily if the area is covered with a wet cloth for a few minutes before cleaning.

## After riding in the rain, near the sea or on salt-sprayed roads

Since sea salt or salt sprayed on roads during winter are extremely corrosive in combination with water, carry out the following steps after each ride in the rain, near the sea or on salt-sprayed roads.

### **NOTE:** \_\_\_\_\_

Salt sprayed on roads in the winter may remain well into spring.

1. Clean the motorcycle with cold water and a mild detergent, after the engine has cooled down.

ECA10790

### **CAUTION:** \_\_\_\_\_

**Do not use warm water since it increases the corrosive action of the salt.**

2. After drying the motorcycle, apply a corrosion protection spray on all metal, including chrome- and nickel-plated, surfaces to prevent corrosion.

### **After cleaning**

1. Dry the motorcycle with a chamois or an absorbing cloth.
2. Immediately dry the drive chain and lubricate it to prevent it from rusting.
3. Use a chrome polish to shine chrome, aluminum and stainless-steel parts, including the exhaust system. (Even the thermally induced discoloring of stainless-steel exhaust systems can be removed through polishing.)

4. To prevent corrosion, it is recommended to apply a corrosion protection spray on all metal, including chrome- and nickel-plated, surfaces.
5. Use spray oil as a universal cleaner to remove any remaining dirt.
6. Touch up minor paint damage caused by stones, etc.
7. Wax all painted surfaces.
8. Let the motorcycle dry completely before storing or covering it.

EWA10930

### **! WARNING** \_\_\_\_\_

- **Make sure that there is no oil or wax on the brakes or tires. If necessary, clean the brake discs and brake linings with a regular brake disc cleaner or acetone, and wash the tires with warm water and a mild detergent.**
  - **Before operating the motorcycle test its braking performance and cornering behavior.**
-

# MOTORCYCLE CARE AND STORAGE

ECA10800

## CAUTION:

- Apply spray oil and wax sparingly and make sure to wipe off any excess.
- Never apply oil or wax to any rubber and plastic parts, but treat them with a suitable care product.
- Avoid using abrasive polishing compounds as they will wear away the paint.

## NOTE:

Consult a Yamaha dealer for advice on what products to use.

## Storage

### Short-term

Always store your motorcycle in a cool, dry place and, if necessary, protect it against dust with a porous cover.

EAU26201

ECA10810

## CAUTION:

- Storing the motorcycle in a poorly ventilated room or covering it with a tarp, while it is still wet, will allow water and humidity to seep in and cause rust.
- To prevent corrosion, avoid damp cellars, stables (because of the presence of ammonia) and areas where strong chemicals are stored.

### Long-term

Before storing your motorcycle for several months:

1. Follow all the instructions in the “Care” section of this chapter.
2. Fill up the fuel tank and add fuel stabilizer (if available) to prevent the fuel tank from rusting and the fuel from deteriorating.

3. Perform the following steps to protect the cylinders, piston rings, etc. from corrosion.
  - a. Remove the spark plug caps and spark plugs.
  - b. Pour a teaspoonful of engine oil into each spark plug bore.
  - c. Install the spark plug caps onto the spark plugs, and then place the spark plugs on the cylinder head so that the electrodes are grounded. (This will limit sparking during the next step.)
  - d. Turn the engine over several times with the starter. (This will coat the cylinder walls with oil.)
  - e. Remove the spark plug caps from the spark plugs, and then install the spark plugs and the spark plug caps.

EWA10950

## WARNING

**To prevent damage or injury from sparking, make sure to ground the spark plug electrodes while turning the engine over.**

# MOTORCYCLE CARE AND STORAGE

---

4. Lubricate all control cables and the pivoting points of all levers and pedals as well as of the side-stand/centerstand.
5. Check and, if necessary, correct the tire air pressure, and then lift the motorcycle so that both of its wheels are off the ground. Alternatively, turn the wheels a little every month in order to prevent the tires from becoming degraded in one spot.
6. Cover the muffler outlets with plastic bags to prevent moisture from entering them.
7. Remove the battery and fully charge it. Store it in a cool, dry place and charge it once a month. Do not store the battery in an excessively cold or warm place [less than 0 °C (30 °F) or more than 30 °C (90 °F)]. For more information on storing the battery, see page 6-27.

**NOTE:** \_\_\_\_\_

Make any necessary repairs before storing the motorcycle.

---



## Dimensions:

- Overall length:  
2095 mm (82.5 in)
- Overall width:  
750 mm (29.5 in)
- Overall height:  
1215 mm (47.8 in)
- Seat height:  
795 mm (31.3 in)
- Wheelbase:  
1440 mm (56.7 in)
- Ground clearance:  
145 mm (5.71 in)
- Minimum turning radius:  
2800 mm (110.2 in)

## Weight:

- With oil and fuel:  
207.0 kg (456 lb)

## Engine:

- Engine type:  
Liquid cooled 4-stroke, DOHC
- Cylinder arrangement:  
Forward-inclined parallel 4-cylinder
- Displacement:  
600.0 cm<sup>3</sup> (36.61 cu.in)
- Bore × stroke:  
65.5 × 44.5 mm (2.58 × 1.75 in)
- Compression ratio:  
12.20 :1
- Starting system:  
Electric starter
- Lubrication system:  
Wet sump

## Engine oil:

- Type:  
SAE10W30 or SAE10W40 or SAE15W40  
or SAE20W40 or SAE20W50

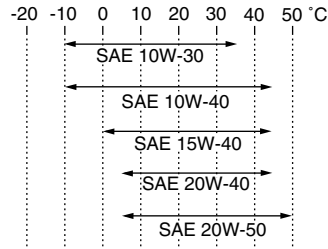

- Recommended engine oil grade:  
API service SE, SF, SG type or higher
- Engine oil quantity:  
Without oil filter cartridge replacement:  
2.50 L (2.64 US qt) (2.20 Imp.qt)  
With oil filter cartridge replacement:  
2.80 L (2.96 US qt) (2.46 Imp.qt)

## Cooling system:

- Coolant reservoir capacity (up to the maximum level mark):  
0.27 L (0.29 US qt) (0.24 Imp.qt)
- Radiator capacity (including all routes):  
2.00 L (2.11 US qt) (1.76 Imp.qt)

## Air filter:

- Air filter element:  
Oil-coated paper element

## Fuel:

- Recommended fuel:  
Regular unleaded gasoline only
- Fuel tank capacity:  
19.4 L (5.13 US gal) (4.27 Imp.gal)
- Fuel reserve amount:  
3.6 L (0.95 US gal) (0.79 Imp.gal)

## Fuel injection:

- Manufacturer:  
MIKUNI
- Model/quantity:  
36EIDW x 2

## Spark plug (s):

- Manufacturer/model:  
NGK/CR9EK
- Spark plug gap:  
0.6–0.7 mm (0.024–0.028 in)

## Clutch:

- Clutch type:  
Wet, multiple-disc

## Transmission:

- Primary reduction system:  
Spur gear
- Primary reduction ratio:  
86/44 (1.955)
- Secondary reduction system:  
Chain drive
- Secondary reduction ratio:  
46/16 (2.875)
- Transmission type:  
Constant mesh 6-speed
- Operation:  
Left foot operation

# SPECIFICATIONS

## Gear ratio:

- 1st:  
37/13 (2.846)
- 2nd:  
37/19 (1.947)
- 3rd:  
28/18 (1.556)
- 4th:  
32/24 (1.333)
- 5th:  
25/21 (1.190)
- 6th:  
26/24 (1.083)

## Chassis:

- Frame type:  
Diamond
- Caster angle:  
25.00 °
- Trail:  
97.5 mm (3.84 in)

## Front tire:

- Type:  
Tubeless
- Size:  
120/70 ZR17M/C (58W)
- Manufacturer/model:  
BRIDGESTONE/BT020F GG
- Manufacturer/model:  
DUNLOP/D252F

## Rear tire:

- Type:  
Tubeless
- Size:  
180/55 ZR17M/C (73W)

Manufacturer/model:  
BRIDGESTONE/BT020R GG

Manufacturer/model:  
DUNLOP/D252

## Loading:

Maximum load:  
190 kg (419 lb)  
(Total weight of rider, passenger, cargo and accessories)

## Tire air pressure (measured on cold tires):

Loading condition:  
0–90 kg (0–198 lb)  
Front:  
225 kPa (33 psi) (2.25 kgf/cm<sup>2</sup>)

Rear:  
250 kPa (36 psi) (2.50 kgf/cm<sup>2</sup>)

Loading condition:  
90–190 kg (198–419 lb)  
Front:  
250 kPa (36 psi) (2.50 kgf/cm<sup>2</sup>)

Rear:  
290 kPa (42 psi) (2.90 kgf/cm<sup>2</sup>)

High-speed riding:  
Front:  
225 kPa (33 psi) (2.25 kgf/cm<sup>2</sup>)  
Rear:  
250 kPa (36 psi) (2.50 kgf/cm<sup>2</sup>)

## Front wheel:

Wheel type:  
Cast wheel  
Rim size:  
17M/C x MT3.50

## Rear wheel:

Wheel type:  
Cast wheel  
Rim size:  
17M/C x MT5.50

## Front brake:

Type:  
Dual disc brake  
Operation:  
Right hand operation  
Recommended fluid:  
DOT 4

## Rear brake:

Type:  
Single disc brake  
Operation:  
Right foot operation  
Recommended fluid:  
DOT 4

## Front suspension:

Type:  
Telescopic fork  
Spring/shock absorber type:  
Coil spring/oil damper  
Wheel travel:  
130.0 mm (5.12 in)

## Rear suspension:

Type:  
Swingarm (monocross)  
Spring/shock absorber type:  
Coil spring/gas-oil damper  
Wheel travel:  
130.0 mm (5.12 in)

## Electrical system:

- Ignition system:
  - Transistorized coil ignition (digital)
- Charging system:
  - AC magneto

## Battery:

- Model:
  - GT12B-4
- Voltage, capacity:
  - 12 V, 10.0 Ah

## Headlight:

- Bulb type:
  - Halogen bulb

## Bulb voltage, wattage × quantity:

- Headlight:
  - 12 V, 60 W/55.0 W × 1
- Headlight:
  - 12 V, 55.0 W × 1
- Tail/brake light:
  - 12 V, 5.0 W/21.0 W × 1
- Front turn signal light:
  - 12 V, 10.0 W × 2
- Rear turn signal light:
  - 12 V, 10.0 W × 2
- Auxiliary light:
  - 12 V, 5.0 W × 2
- License plate light:
  - 12 V, 5.0 W × 1
- Meter lighting:
  - EL (LCD backlight)
- Neutral indicator light:
  - LED
- High beam indicator light:
  - LED

- Oil level warning light:
  - LED
- Turn signal indicator light:
  - LED
- Engine trouble warning light:
  - LED
- Immobilizer system indicator light:
  - LED

## Fuses:

- Main fuse:
  - 30.0 A
- Headlight fuse:
  - 20.0 A
- Signaling system fuse:
  - 10.0 A
- Ignition fuse:
  - 10.0 A
- Parking lighting fuse:
  - 10.0 A
- Radiator fan fuse:
  - 20.0 A
- Fuel injection system fuse:
  - 10.0 A
- Backup fuse:
  - 10.0 A

# CONSUMER INFORMATION

EAU26351

## Identification numbers

Record the key identification number, vehicle identification number and model label information in the spaces provided below for assistance when ordering spare parts from a Yamaha dealer or for reference in case the vehicle is stolen.

KEY IDENTIFICATION NUMBER:

VEHICLE IDENTIFICATION NUMBER:

MODEL LABEL INFORMATION:

## Key identification number

EAU26381

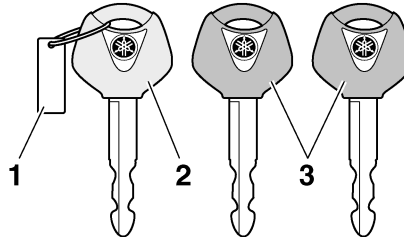

1. Key identification number
2. Code re-registering key (red bow)
3. Standard keys (black bow)

The key identification number is stamped into the key tag. Record this number in the space provided and use it for reference when ordering a new key.

## Vehicle identification number

EAU26400

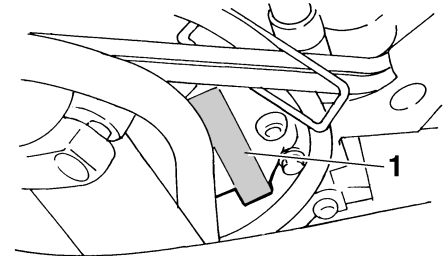

1. Vehicle identification number

The vehicle identification number is stamped into the steering head pipe. Record this number in the space provided.

**NOTE:** \_\_\_\_\_

The vehicle identification number is used to identify your motorcycle and may be used to register your motorcycle with the licensing authority in your area.

\_\_\_\_\_

EAU26540

## Model label

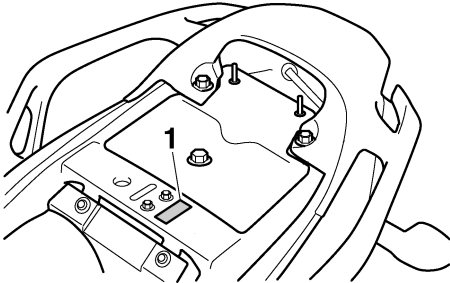

### 1. Model label

The model label is affixed to the frame under the seat. (See page 3-13.) Record the information on this label in the space provided. This information will be needed when ordering spare parts from a Yamaha dealer.

# INDEX

---

## A

- Air filter element, replacing ..... 6-12
- Anti-theft alarm (optional)..... 3-8
- Auxiliary light bulb, replacing ..... 6-32

## B

- Battery..... 6-27
- Brake and clutch levers,  
checking and lubricating ..... 6-24
- Brake and shift pedals,  
checking and lubricating ..... 6-23
- Brake fluid, changing ..... 6-20
- Brake fluid level, checking ..... 6-19
- Brake lever ..... 3-10
- Brake pedal..... 3-11

## C

- Cables, checking and lubricating ..... 6-22
- Care ..... 7-1
- Catalytic converter ..... 3-13
- Centerstand and sidestand,  
checking and lubricating ..... 6-24
- Clutch lever ..... 3-10
- Clutch lever free play, adjusting ..... 6-17
- Coolant..... 6-10

## D

- Dimmer switch ..... 3-9
- Drive chain, cleaning and lubricating .... 6-22
- Drive chain slack..... 6-20

## E

- Engine break-in..... 5-3
- Engine idling speed..... 6-13
- Engine oil and oil filter cartridge..... 6-7
- Engine stop switch ..... 3-9
- Engine trouble warning light..... 3-4

## F

- Front and rear brake pads, checking.... 6-18
- Front fork, checking..... 6-25
- Fuel..... 3-12
- Fuel consumption, tips for reducing..... 5-3
- Fuel tank breather hose..... 3-13
- Fuel tank cap ..... 3-11
- Fuses, replacing ..... 6-28

## H

- Handlebar switches ..... 3-8
- Hazard switch ..... 3-9
- Headlight bulb, replacing ..... 6-29
- High beam indicator light ..... 3-4
- Horn switch..... 3-9

## I

- Identification numbers ..... 9-1
- Ignition circuit cut-off system ..... 3-16
- Immobilizer system ..... 3-1
- Immobilizer system indicator light..... 3-4
- Indicator and warning lights ..... 3-3

## K

- Key identification number ..... 9-1

## L

- LCD tachometer ..... 3-5
- License plate light bulb, replacing ..... 6-31

## M

- Main switch/steering lock..... 3-2
- Model label ..... 9-2
- Multi-function display ..... 3-5

## N

- Neutral indicator light..... 3-3

## O

- Oil level warning light..... 3-4

## P

- Panels, removing and installing ..... 6-5
- Parking ..... 5-4
- Part locations ..... 2-1
- Pass switch ..... 3-9
- Periodic maintenance and lubrication  
chart ..... 6-2
- Pre-operation check list..... 4-2

## R

- Rear brake light switch, adjusting ..... 6-18

## S

- Safety information ..... 1-1
- Seat ..... 3-13
- Shifting ..... 5-2
- Shift pedal ..... 3-10
- Shock absorber assembly, adjusting .... 3-15
- Sidestand ..... 3-16
- Spark plugs, checking ..... 6-6
- Specifications ..... 8-1
- Starting the engine ..... 5-1
- Start switch ..... 3-9
- Steering, checking..... 6-26
- Storage..... 7-3
- Storage compartment..... 3-14
- Swingarm pivots, lubricating ..... 6-25

## T

- Tail/brake light bulb, replacing ..... 6-30
- Throttle cable free play, checking ..... 6-14
- Throttle grip and cable,  
checking and lubricating ..... 6-23
- Tires ..... 6-14
- Tool kit..... 6-1
- Troubleshooting ..... 6-36
- Troubleshooting charts..... 6-37

Turn signal indicator lights ..... 3-3  
Turn signal light bulb, replacing ..... 6-31  
Turn signal switch ..... 3-9

## **V**

Valve clearance ..... 6-14  
Vehicle identification number ..... 9-1

## **W**

Wheel bearings, checking ..... 6-26  
Wheel (front) ..... 6-33  
Wheel (rear) ..... 6-34  
Wheels ..... 6-17









PRINTED ON RECYCLED PAPER

PRINTED IN JAPAN  
2005.08-0.3×1 CR  
(E)