



OWNER'S MANUAL
MANUEL DU PROPRIÉTAIRE
USO E MANUTENZIONE
INSTRUKTIONSBOK
OMISTAJAN KÄSIKIRJA
EIERHÅNDBOK

(E)

(F)

(I)

(S)

(SF)

(N)

- (E) Read this manual carefully before operating this vehicle.
- (F) Il convient de lire attentivement ce manuel avant la première utilisation du véhicule.
- (I) Leggere attentamente questo manuale prima di utilizzare questo veicolo.
- (S) Läs den här instruktionsboken noga innan snöskotern används.
- (SF) Lue tämä käsikirja huolellisesti ennen moottorikelkan käyttöä.
- (N) Les denne håndboken nøye før du tar kjøretøyet i bruk.

FX Nitro

FX10D
FX10RTRSD
FX10XTD
FX10XT75D
FX10M53SD
FX10M62SD



PRINTED IN JAPAN
2012.06-0.5×1 CR

PRINTED ON RECYCLED PAPER
IMPRIMÉ SUR PAPIER RECYCLÉ
STAMPATO SU CARTA RICICLATA
TRYCKT PÅ ÅTERVUNNET PAPPER
PAINETTU UUSIOPAPERILLE
TRYKKET PÅ RESIRKULERT PAPIR



OWNER'S MANUAL

 Read this manual carefully
before operating this vehicle.

FX Nitro

FX10D
FX10RTRSD
FX10XTD
FX10XT75D
FX10M53SD
FX10M62SD

8HK-28199-S4-E0



Read this manual carefully before operating this vehicle. This manual should stay with this vehicle if it is sold.

EC Declaration of Conformity

conforming to Directive 2006/42/EC

We, YAMAHA MOTOR CO., LTD. 2500 Shingai, Iwata, Japan, declare in sole responsibility, that the product

RFX10ST2S	(FX10XT75)	(JYE&JJ00*DA000001-)
RFX10RMS	(FX10M62S)	(JYE8HR00*DA005174-)
RFX10RMS2	(FX10M53S)	(JYE8HU00*DA001653-)
RFX10ST2	(FX10XT)	(JYE8HL00*DA015772-)
RFX10RSS	(FX10RTRS)	(JYE8HK00*DA002903-)

(Make, model)

to which this declaration applies, conforms to the essential health and safety requirements of Directive 2006/42/EC

(If applicable)

**and to the other relevant Directive of EEC
2004/108/EC**

(Title and/or number and date of issue of the other Directives of EEC)

(If applicable)

To effect correct application of the essential health and safety requirements stated in the Directives of EEC, the following-standards and/or technical specifications were consulted:

(Title and/or number and date of issue of standards and/or specifications)

Authorized Representative

YAMAHA MOTOR EUROPE N.V.

Koolhovenlaan 101, 1119 NC Schiphol-Rijk, The Netherlands

Signature

Eiji Kato

General Manager
RV Engineering Division
MC Operations

Date of Issue 18 October, 2011

Introduction

ESU10131

Congratulations on your purchase of a Yamaha snowmobile. This model is the result of Yamaha's vast experience in the production of fine sporting and touring snowmobiles. It represents the high degree of craftsmanship and reliability that have made Yamaha a leader in these fields.

This manual will give you an understanding of the operation, inspection, and basic maintenance of this snowmobile. If you have any questions concerning the operation or maintenance of your snowmobile, please consult a Yamaha dealer.

Yamaha continually seeks advancements in product design and quality. Therefore, while this manual contains the most current product information available at the time of printing, there may be minor discrepancies between your snowmobile and this manual. If there is any question concerning this manual, please consult a Yamaha dealer.

EWS00670



Please read this manual carefully before operating this snowmobile. Do not attempt to operate this snowmobile until you have attained adequate knowledge of its controls and operating features.

Regular inspections and careful maintenance, along with good operating techniques, will help ensure that you safely enjoy the capabilities and reliability of this snowmobile.

**FX10D
FX10RTRSD
FX10XTD
FX10XT75D
FX10M53SD
FX10M62SD**

OWNER'S MANUAL

©2012 by Yamaha Motor Co., Ltd.

1st Edition, March 2012

All rights reserved.

**Any reprinting or unauthorized use
without the written permission of
Yamaha Motor Co., Ltd.**

is expressly prohibited.

Printed in Japan.

Important manual information

ESU10151

Particularly important information is distinguished in this manual by the following notations.



This is the safety alert symbol. It is used to alert you to potential personal injury hazards. Obey all safety messages that follow this symbol to avoid possible injury or death.

EWS00021



WARNING

A WARNING indicates a hazardous situation which, if not avoided, could result in death or serious injury.

ECS00011

NOTICE

A NOTICE indicates special precautions that must be taken to avoid damage to the snowmobile or other property.

TIP

A TIP provides key information to make procedures easier or clearer.

Contents

Location of the important labels	1	Operation	50
Safety information	16	Starting the engine	50
Description	19	Break-in	51
Control functions	21	Riding your snowmobile	51
Main switch	21	Maximizing drive track life	55
Throttle lever	21	Strap (FX10M53S/FX10M62S)	56
Throttle override system (T.O.R.S.)	21	Driving	56
Multi-function meter unit	22	Stopping the engine	57
High beam indicator light	23	Transporting	58
Low coolant temperature indicator light	23	Periodic maintenance and adjustment	59
Fuel meter and grip/thumb warmer level indicator	24	Periodic maintenance chart for the emission control system	60
Fuel level warning indicator	25	General maintenance and lubrication chart	61
Oil level/pressure warning indicator	25	Tool kit	63
Coolant temperature warning indicator	26	Recommended equipment	63
Self-diagnosis device	26	Removing and installing the shroud and covers	63
Engine stop switch	27	Checking the spark plugs	65
Headlight beam switch “LIGHTS”	27	Adjusting the throttle lever free play	66
Grip/thumb warmer adjusting switch	27	Checking the throttle override system (T.O.R.S.)	66
Auxiliary DC jack (FX10M53S/FX10M62S)	28	Checking the air filter	67
Brake lever	28	High-altitude settings	68
Parking brake lever	29	Valve clearance	68
Shift lever	29	Engine oil and oil filter cartridge ...	69
Drive guard	30	Cooling system	74
Storage pouch	31	V-belt	76
Fuel	32	Drive chain housing	78
Suspension	33	Brake and parking brake	79
Pre-operation checks	48	Extrovert drive sprocket (FX10/FX10RTRS/FX10XT75/ FX10M53S/FX10M62S)	82
Pre-operation check list	48	Skis and ski runners	83
		Steering system	84
		Drive track and slide runners	84
		High-profile pattern drive track	87
		Lubrication	88
		Replacing a headlight bulb	89

Contents

- Adjusting the headlight beams 89
- Fittings and fasteners 90
- Battery 90
- Replacing a fuse 91

- Troubleshooting 93**

- Storage 96**

- Specifications 98**

- Consumer information..... 102**
 - Identification number records 102
 - Vehicle Emission Control
Information label
(for CANADA) 102
 - WARRANTY..... 102

Location of the important labels

ESU12678

Read and understand all of the labels on your vehicle. They contain important information for safe and proper operation of your vehicle. Never remove any labels from your vehicle. If a label becomes difficult to read or comes off, a replacement label is available from your Yamaha dealer.

For CANADA

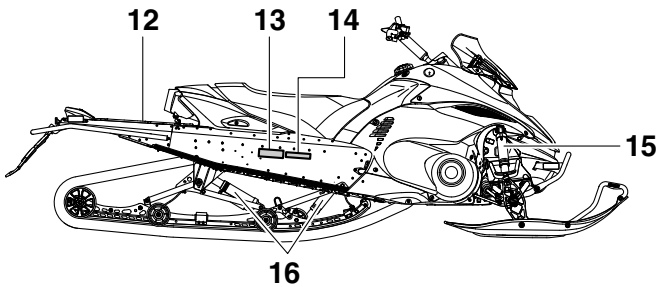
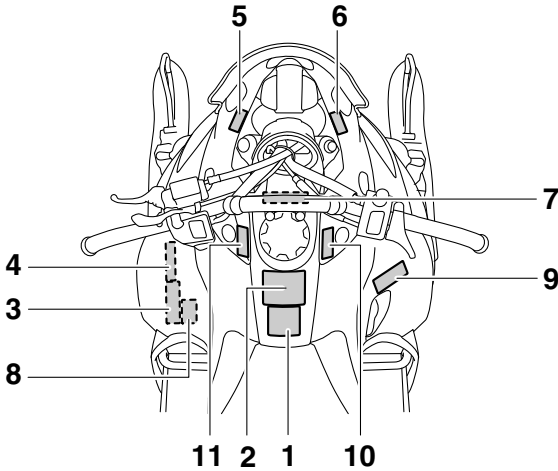

Location of the important labels

1 FX10M53S/FX10M62S

▲ WARNING

Improper use of STRAP on the handlebar can result in SEVERE INJURY or DEATH.

- Use strap only as an operator grip point to shift weight uphill to maintain balance during traverse (sidehill) riding.
- Keep one hand on handlebar.
- Do not change speed or direction abruptly.
- Only experienced operators should traverse slopes steep enough to require strap use.

▲ AVERTISSEMENT

L'utilisation incorrecte de la POIGNÉE SUPPLE du guidon peut causer des BLESSURES GRAVES voire MORTELLES.

- S'agripper à la poignée seulement lors de la traversée latérale de pentes pour garder l'équilibre lorsque l'on déplace son poids du côté amont.
- Garder une main sur le guidon.
- Éviter toute accélération ou freinage brusques.
- La traversée de pentes dont la raideur requiert l'utilisation de la poignée est réservée aux pilotes expérimentés.

BGP-77761-00

2

▲ WARNING

SEVERE INJURY OR DEATH MAY RESULT IF YOU IGNORE ANY OF THE FOLLOWING:

- Read the Owner's Manual and all labels before operating this vehicle.
- This vehicle is a high performance machine. It should be operated by an experienced operator.
- Check throttle, brake, and steering for proper operation before starting engine.
- Set parking brake before attempting to start engine.
- Never run this vehicle with the parking brake applied.
- To stop engine in an emergency, push the engine stop switch down.
- Do not operate engine without drive belt or drive guard.
- Make sure the fuel tank cap is closed securely after refueling.
- Do not operate this vehicle on public roads. You could collide with another vehicle.
- This vehicle is designed for operator only - no passengers.
- Check lever position (Forward or Reverse) before moving.
- Wear an approved helmet, eye protection, and adequate clothing for snowmobiling.

▲ AVERTISSEMENT

AFIN D'ÉVITER TOUT RISQUE DE BLESSURE SÉRIEUSE OU MÊME MORTELLE, VEUILLEZ SUIVRE LES RECOMMANDATIONS SUIVANTES:

- Avant d'utiliser ce véhicule, lire le manuel du propriétaire et toutes les étiquettes.
- Ce véhicule est une machine à haute performance. Elle doit être conduite par un conducteur expérimenté.
- Avant de démarrer le moteur, vérifier l'opération du frein, de l'accélérateur et de la direction.
- Le frein de sécurité doit être appliqué lors du démarrage. Ne pas rouler avec le frein de sécurité actionné.
- En cas d'urgence, utiliser l'interrupteur d'arrêt du moteur.
- Ne pas laisser tourner le moteur sans le couvre-cas sans garde.
- S'assurer que le bouchon du réservoir soit bien refermé après le remplissage.
- Afin d'éviter tout risque de collision, ne pas rouler sur un chemin public.
- Ce véhicule est conçu pour un conducteur seul - aucun passager.
- Vérifier la position du levier (marche avant ou arrière) avant d'être en marche.
- Toujours porter un casque approuvé et un habillement de motoneigiste.
- Prévoir une protection pour les yeux.

BGL-77761-00

3 FX10XT

TUNE-UP SPECIFICATIONS

DRIVE

1. CHAIN CASE OIL Q'TY 200 cm³ (6,8 oz)
2. CHAIN CASE OIL TYPE GL-3 75W or 80W
3. TRACK TENSION 25 - 30 mm (0,98 - 1,18 in)/100 N (10 kg, 22 lb)

- * FOR MORE INFO: SEE SERVICE MANUAL FOR THIS MODEL.
- * SPECIFICATIONS SUBJECT TO CHANGE WITHOUT NOTICE.

SPECIFICATIONS DE LA MISE AU POINT

ENTRAÎNEMENT

1. CAPACITÉ D'HUILE DU CARTER DE CHAÎNE 200 cm³
2. TYPE D'HUILE DU CARTER DE CHAÎNE GL-3 75W or 80W
3. FLÈCHE DE LA CHENILLE 25 - 30 mm/100 N (10 kg)

- * POUR PLUS DE DÉTAIL: VOIR LE MANUEL D'ATELIER POUR CE MODÈLE.
- * LES CARACTÉRISTIQUE TECHNIQUES SONT SUSCEPTIBLES DE CHANGER SANS NOTIFICATION PRÉALABLE.

8GL-47578-00

3 FX10/FX10RTS/FX10XT75

TUNE-UP SPECIFICATIONS

DRIVE

1. CHAIN CASE OIL Q'TY 200 cm³ (6,8 oz)
2. CHAIN CASE OIL TYPE GL-3 75W or 80W
3. TRACK TENSION 30 - 35 mm (1,18 - 1,38 in)/100 N (10 kg, 22 lb)

- * FOR MORE INFO: SEE SERVICE MANUAL FOR THIS MODEL.
- * SPECIFICATIONS SUBJECT TO CHANGE WITHOUT NOTICE.

SPECIFICATIONS DE LA MISE AU POINT

ENTRAÎNEMENT

1. CAPACITÉ D'HUILE DU CARTER DE CHAÎNE 200 cm³
2. TYPE D'HUILE DU CARTER DE CHAÎNE GL-3 75W or 80W
3. FLÈCHE DE LA CHENILLE 30 - 35 mm/100 N (10 kg)

- * POUR PLUS DE DÉTAIL: VOIR LE MANUEL D'ATELIER POUR CE MODÈLE.
- * LES CARACTÉRISTIQUE TECHNIQUES SONT SUSCEPTIBLES DE CHANGER SANS NOTIFICATION PRÉALABLE.

8HA-47578-00

3 FX10M53S/FX10M62S

TUNE-UP SPECIFICATIONS

DRIVE

1. CHAIN CASE OIL Q'TY 200 cm³ (6,8 oz)
2. CHAIN CASE OIL TYPE GL-3 75W or 80W
3. TRACK TENSION 40 - 45 mm (1,57 - 1,77 in)/100 N (10 kg, 22 lb)

- * FOR MORE INFO: SEE SERVICE MANUAL FOR THIS MODEL.
- * SPECIFICATIONS SUBJECT TO CHANGE WITHOUT NOTICE.

SPECIFICATIONS DE LA MISE AU POINT

ENTRAÎNEMENT

1. CAPACITÉ D'HUILE DU CARTER DE CHAÎNE 200 cm³
2. TYPE D'HUILE DU CARTER DE CHAÎNE GL-3 75W or 80W
3. FLÈCHE DE LA CHENILLE 40 - 45 mm/100 N (10 kg)

- * POUR PLUS DE DÉTAIL: VOIR LE MANUEL D'ATELIER POUR CE MODÈLE.
- * LES CARACTÉRISTIQUE TECHNIQUES SONT SUSCEPTIBLES DE CHANGER SANS NOTIFICATION PRÉALABLE.

8HR-47578-00

4

TUNE-UP SPECIFICATIONS

ENGINE

1. SPARK PLUG CR9E(NGK)
2. SPARK PLUG GAP 0,7 - 0,8 mm (0,028 - 0,031 in)
3. IDLE SPEED 1500 ± 50 r/min

SPECIFICATIONS DE LA MISE AU POINT ^{BGL}

MOTEUR

1. TYPE DE BOUGIE CR9E(NGK)
2. ECARTEMENT DES ÉLECTRODES 0,7 - 0,8 mm
3. RÉGIME DE RALENTI 1500 ± 50 r/min

BGL-1417E-00

Location of the important labels

5

ATTENTION

- Eviter de nettoyer le pare-brise avec une solution alcaline ou acide ainsi qu'avec de l'essence ou un diluant.
- Utiliser un détergent neutre.

8ET-2815K-10

6

NOTICE

- Cleaning with alkaline or acid cleaner, gasoline or solvent will damage windshield.
- Use neutral detergent.

8ET-2815K-00

7 FX10XT75/FX10M53S/FX10M62S

NOTICE

- This snowmobile is originally equipped with a high-profile pattern track of more than 38 mm (1.5 in.) for deep snow riding conditions.
- Operation on light snowfall, ice, hard-packed snow, dirt, etc., will result in rapid wear or damage to track and slide runners.

ATTENTION

- Cette motoneige est équipée de série d'une chenille à crampons de plus de 38 mm (1,5 in.) pour la conduite sur neige profonde.
- La conduite sur de la neige peu profonde, de la glace, de la neige tassée, de la saleté, etc. provoquera une usure rapide ou l'endommagement de la chenille et des patins.

8JJ-2815M-E0

8

⚠ WARNING

DO NOT OPERATE ENGINE WITHOUT V-BELT OR DRIVE GUARD.

⚠ AVERTISSEMENT

NE PAS FAIRE FONCTIONNER LE MOTEUR SANS COURROIE EN V OU PROTECTEUR D'EMBRAYAGE.

8BD-7776D-00

9

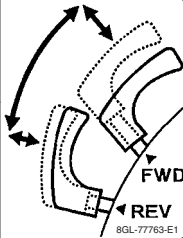
<p>SHIFTING INSTRUCTIONS</p> <ul style="list-style-type: none"> • Shift only with the machine stopped and the engine idling. • Pull the shift lever out, then slide it to the forward (FWD) or reverse (REV) position until it stops. Push the shift lever in. 	
<p>INSTRUCTIONS DE CHANGEMENT DE MARCHÉ</p> <ul style="list-style-type: none"> • N'inverser la marche que lorsque le véhicule est à l'arrêt et que le moteur tourne au ralenti. • Tirer sur la sélection, puis le faire glisser vers la position de marche avant (FWD) ou arrière (REV) jusqu'à son arrêt. Repousser la sélection. 	

8GL-7776S-E1

10

⚠ WARNING

This vehicle is designed for operator only.

"NO PASSENGER"

8GC-7776Z-A0

11

⚠ AVERTISSEMENT

Ce véhicule est conçu pour ne transporter que le conducteur.

"AUCUN PASSAGER"

8GC-7776Z-B0

12 FX10XT/FX10XT75/FX10M53S/FX10M62S

<p style="text-align: center;">⚠ WARNING</p> <p>NO PASSENGERS OR CARGO ON THIS TRACK COVER. It was not designed to carry weight. It could bend or break under load. Anything placed here could block the view of the brake/tail light which could cause an accident.</p>	<p style="text-align: center;">⚠ AVERTISSEMENT</p> <p>AUCUN PASSAGER OU MARCHANDISE SUR LE PROTECTEUR DE CHENILLE. Ce protecteur n'a pas été conçu pour supporter un poids. Il pourrait s'incurver ou se briser sous la charge. Tout objet ou personne placé à cet endroit pourrait bloquer la vue des feux d'arrêt/arrière et ainsi causer un accident.</p>
--	--

8HA-7776Z-E0

13

<p>CE MODÈLE A ÉTÉ ÉVALUÉ PAR UN LABORATOIRE D'ESSAIS INDÉPENDANT ET SATISFAIT TOUTES LES NORMES DE SÉCURITÉ DU SSCC EN VIGUEUR À LA DATE DE FABRICATION.</p> <p>PARRAINE PAR LE COMITÉ DE SÉCURITÉ ET DE CERTIFICATION DE LA MOTONEIGE, INC.</p>	<p>CERTIFIED</p>  <p>CERTIFIÉ</p> 	<p>THIS MODEL HAS BEEN EVALUATED BY AN INDEPENDENT TESTING LABORATORY AND IT MEETS ALL SSCC SAFETY STANDARDS IN EFFECT ON THE DATE OF ITS MANUFACTURE.</p> <p>SPONSORED BY THE SNOWMOBILE SAFETY AND CERTIFICATION COMMITTEE, INC.</p>
---	--	--

88C-77769-00

Location of the important labels

14

	<p>This spark ignition system meets all requirements of the Canadian Interference Causing Equipment Regulations.</p> <p>Ce système d'allumage par étincelle de véhicule respecte toutes les exigences du Règlement sur le matériel brouilleur du Canada.</p>
3JK-82377-10	

FX10/FX10XT/FX10XT75
15,16
FX10RTRS
16

<p>⚠ WARNING</p> <p>This unit contains high pressure nitrogen gas. Mishandling can cause explosion.</p> <ul style="list-style-type: none"> • Read owner's manual for instructions. • Do not incinerate, puncture or open.
<p>⚠ AVERTISSEMENT</p> <p>Cette unité contient de l'azote à haute pression. Une mauvaise manipulation peut entraîner d'explosion.</p> <ul style="list-style-type: none"> • Voir le manuel d'utilisateur pour les instructions. • Ne pas brûler ni perforer ni ouvrir.
4AA-22259-70

FX10RTRS

15



<p>⚠ WARNING</p> <p>This unit contains high pressure nitrogen gas. Mishandling can cause explosion.</p> <ul style="list-style-type: none"> • Read owner's manual for instructions. • Do not incinerate, puncture or open. 	
<p>⚠ AVERTISSEMENT</p> <p>Cette unité contient de l'azote à haute pression. Une mauvaise manipulation peut entraîner d'explosion.</p> <ul style="list-style-type: none"> • Voir le manuel d'utilisateur pour les instructions. • Ne pas brûler ni perforer ni ouvrir. 	<p>⚠ 警告</p> <p>高圧窒素ガス入りです。取扱いを誤ると爆発する恐れがあります。</p> <ul style="list-style-type: none"> • 取扱説明書をよく読んでください。 • 火中への投入、孔あけ、分解はしないでください。
8GTF-2259-50	

FX10M53S/FX10M62S

15

<p>⚠ WARNING</p> <p>This unit contains high pressure nitrogen gas. Mishandling can cause explosion.</p> <ul style="list-style-type: none"> • Read owner's manual for instructions. • Do not incinerate, puncture or open. 	
<p>⚠ AVERTISSEMENT</p> <p>Cette unité contient de l'azote à haute pression. Une mauvaise manipulation peut entraîner d'explosion.</p> <ul style="list-style-type: none"> • Voir le manuel d'utilisateur pour les instructions. • Ne pas brûler ni perforer ni ouvrir. 	<p>⚠ 警告</p> <p>高圧窒素ガス入りです。取扱いを誤ると爆発する恐れがあります。</p> <ul style="list-style-type: none"> • 取扱説明書をよく読んでください。 • 火中への投入、孔あけ、分解はしないでください。
8HR-22259-00	

16

<p>⚠ WARNING</p> <p>This unit contains high pressure nitrogen gas. Mishandling can cause explosion.</p> <ul style="list-style-type: none"> • Read owner's manual for instructions. • Do not incinerate, puncture or open. 	
<p>⚠ WARNING</p> <p>This unit contains high pressure nitrogen gas. Mishandling can cause explosion.</p> <ul style="list-style-type: none"> • Read owner's manual for instructions. • Do not incinerate, puncture or open. 	
<p>⚠ 警告</p> <p>高圧窒素ガス入りです。取扱いを誤ると爆発する恐れがあります。</p> <ul style="list-style-type: none"> • 取扱説明書をよく読んでください。 • 火中への投入、孔あけ、分解はしないでください。 	<p>⚠ AVERTISSEMENT</p> <p>Cette unité contient de l'azote à haute pression. Une mauvaise manipulation peut entraîner une explosion.</p> <ul style="list-style-type: none"> • Voir le manuel d'utilisateur pour les instructions. • Ne pas brûler ni perforer ni ouvrir.
<p>⚠ 警告</p> <p>高圧窒素ガス入りです。取扱いを誤ると爆発する恐れがあります。</p> <ul style="list-style-type: none"> • 取扱説明書をよく読んでください。 • 火中への投入、孔あけ、分解はしないでください。 	<p>⚠ AVERTISSEMENT</p> <p>Cette unité contient de l'azote sous haute pression. Une mauvaise manipulation peut entraîner une explosion.</p> <ul style="list-style-type: none"> • Voir le manuel d'utilisateur pour les instructions. • Ne pas brûler ni perforer ni ouvrir.
8HR-22259-40	

Location of the important labels

For EUROPE

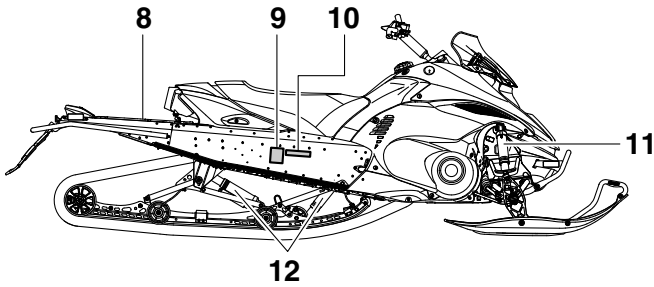
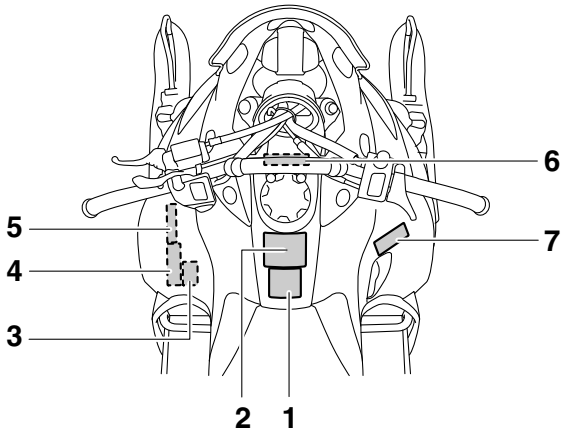

Location of the important labels

1 FX10M53S/FX10M62S

⚠️ VARNING

Felaktig användning av den STROPP som finns på styrstängens kan resultera i ALLVARLIG KROPPSSKADA eller DÖDSOLYCKA.

- Använd stroppen endast som en grepppunkt för föraren vid förekljuring av vikten uppåt i backen för att behålla balansen under tvärgående körning (längs en bergssida).
- Håll ena handen på styrstängens. Andra inte plötsligt hastighet eller körriktning.
- Endast rutinede förare bör köra tvärgående i backar som är så pass branta att de kräver användning av stroppen.

⚠️ VAROITUS

Ohjaustangon HILJANAN virheellinen käyttö saattaa aiheuttaa VAKAVAA VAMMOKUJA tai jopa KUOLEMAN.

- Käytä hitnaa ainoastaan käyttäjän pitekohtana painon siirtämiseksi ylämäkeen tasapainon säilyttämistä varten ajettaessa vinottain (sivuttain).
- Pidä toinen käsi ohjaustangolla. Älä muuta nopeutta tai suuntaa äkillisesti.
- Hilman käyttöä vaativissa syvässä rinteissä vinottain ajaminen on suositeltavaa ainoastaan kokeneille käyttäjille.

86D-77761-10

2

⚠️ VARNING

FÖR DIN SÄKERHET OCH UNDVIKANDE AV SKADA BER VI DIG IAKTA FÖLJANDE:

- Läs instruktionsboken och alla skyltar innan Du Kör detta fordon.
- Detta fordon har hög prestanda och får därför endast köras av en erfaren förare.
- Kontrollera gas, broms och styrning innan Du startar motorn.
- Dra åt parkeringsbromsen innan Du startar motorn. Kör aldrig med parkeringsbromsen ådragen.
- För att stoppa motorn i en nödsituation - tryck ned knappen för nödstopp.
- Kör inte motorn utan variatorrem eller variatorskydd.
- Försäkra Dig om att länklacket är last ordentligt efter tankning.
- Kontrollera växelspakens läge 'F' (framåt) eller 'R' (back) innan Du kör.
- Använd alltid godkänd hjälm, skoterlagsgögen och i övrigt lämplig klädsel för skoterakning.

⚠️ VAROITUS

JOUUDIT VAKAVAA LOUKKAANTUMIS TAI HENGENVAARAAN, ELLET NOUDATA SEURAAVIA OHJEITA:

- Lue käyttäjän käsikirja ja kaikki tarrat, ennen kuin alat käyttää tätä ajoneuvoa.
- Tämä on tehokas ja voimakas ajoneuvo. Se on tarkoitettu kokeneille kuljettajille.
- Tarkista ennen moottorin käynnistystä kaasun, jarrun ja ohjauksen toiminta.
- Laita seisontajarru päälle, ennen kuin alat käynnistää moottoria.
- Älä kuitenkaan missään tapauksessa lähde liikkeelle seisontajarru päällä.
- Häätätilanteissa moottorin voi sammuttaa hätäpysäytintä painamalla.
- Älä käynnistä moottoria, kun suojukset eivät ole paikallaan.
- Muista sulkea polttoainesäiliön tulppa huolella tankkauksen jälkeen.
- Tarkista vaihde vivun asento (eteen tai taakse) ennen liikkeellelähtöä.
- Käytä lumikelkalla ajaessasi hyväksytyllä kypärällä, suojalaseja ja sopivia vaatteita.

86L-77761-50

3

⚠️ VARNING

Kör aldrig motorn utan variatorrem eller med variatorskyddet borttaget.

⚠️ VAROITUS

Älä koskaan käytä kelkkaa ilman variatorrihinaa tai variatorrihinnan suojuksen ollessa irti.

86D-77762-00

4 FX10RTRS/FX10XT75

TUNE-UP SPECIFICATIONS

DRIVE

1. CHAIN CASE OIL QTY 200 cm³ (6.8 oz)
2. CHAIN CASE OIL TYPE GL-3 75W or 80W

3. TRACK TENSION 30 - 35 mm (1.18 - 1.38 in)/100 N (10 kg, 22 lb)

- * FOR MORE INFO: SEE SERVICE MANUAL FOR THIS MODEL.
- * SPECIFICATIONS SUBJECT TO CHANGE WITHOUT NOTICE.

SPECIFICATIONS DE LA MISE AU POINT

ENTRAÎNEMENT

1. CAPACITÉ D'HUILE DU CARTER DE CHAÎNE 200 cm³
2. TYPE D'HUILE DU CARTER DE CHAÎNE GL-3 75W or 80W
3. FLÈCHE DE LA CHENILLE 30 - 35 mm/100 N (10 kg)

- * POUR PLUS DE DÉTAIL: VOIR LE MANUEL D'ATELIER POUR CE MODÈLE.
- * LES CARACTÉRISTIQUES TECHNIQUES SONT SUSCEPTIBLES DE CHANGER SANS NOTIFICATION PRÉALABLE.

8HA-47578-00

4 FX10XT

TUNE-UP SPECIFICATIONS

DRIVE

1. CHAIN CASE OIL QTY 200 cm³ (6.8 oz)
2. CHAIN CASE OIL TYPE GL-3 75W or 80W

3. TRACK TENSION 25 - 30 mm (0.98 - 1.18 in)/100 N (10 kg, 22 lb)

- * FOR MORE INFO: SEE SERVICE MANUAL FOR THIS MODEL.
- * SPECIFICATIONS SUBJECT TO CHANGE WITHOUT NOTICE.

SPECIFICATIONS DE LA MISE AU POINT

ENTRAÎNEMENT

1. CAPACITÉ D'HUILE DU CARTER DE CHAÎNE 200 cm³
2. TYPE D'HUILE DU CARTER DE CHAÎNE GL-3 75W or 80W
3. FLÈCHE DE LA CHENILLE 25 - 30 mm/100 N (10 kg)

- * POUR PLUS DE DÉTAIL: VOIR LE MANUEL D'ATELIER POUR CE MODÈLE.
- * LES CARACTÉRISTIQUES TECHNIQUES SONT SUSCEPTIBLES DE CHANGER SANS NOTIFICATION PRÉALABLE.

8GL-47578-00

4 FX10M53S/FX10M62S

TUNE-UP SPECIFICATIONS

DRIVE

1. CHAIN CASE OIL QTY 200 cm³ (6.8 oz)
2. CHAIN CASE OIL TYPE GL-3 75W or 80W

3. TRACK TENSION 40 - 45 mm (1.57 - 1.77 in)/100 N (10 kg, 22 lb)

- * FOR MORE INFO: SEE SERVICE MANUAL FOR THIS MODEL.
- * SPECIFICATIONS SUBJECT TO CHANGE WITHOUT NOTICE.

SPECIFICATIONS DE LA MISE AU POINT

ENTRAÎNEMENT

1. CAPACITÉ D'HUILE DU CARTER DE CHAÎNE 200 cm³
2. TYPE D'HUILE DU CARTER DE CHAÎNE GL-3 75W or 80W
3. FLÈCHE DE LA CHENILLE 40 - 45 mm/100 N (10 kg)

- * POUR PLUS DE DÉTAIL: VOIR LE MANUEL D'ATELIER POUR CE MODÈLE.
- * LES CARACTÉRISTIQUES TECHNIQUES SONT SUSCEPTIBLES DE CHANGER SANS NOTIFICATION PRÉALABLE.

8HR-47578-00

Location of the important labels

5

TUNE-UP SPECIFICATIONS	SPECIFICATIONS DE LA MISE AU POINT ^{8GL}
ENGINE 1.SPARK PLUG <u>CR9E(NGK)</u> 2.SPARK PLUG GAP <u>0.7 ~ 0.8 mm (0.028 ~ 0.031 in)</u> 3.IDLE SPEED <u>1500 ± 50 r/min</u>	MOTEUR 1.TYPE DE BOUGIE <u>CR9E(NGK)</u> 2.ECARTEMENT DES ÉLECTRODES <u>0.7 ~ 0.8 mm</u> 3.RÉGIME DE RALENTI <u>1500 ± 50 r/min</u>

8GL-1417E-00

6 FX10XT75/FX10M53S/FX10M62S

VIKTIGT
<ul style="list-style-type: none">• Snöskotern är originalutrustad med ett spårmonster med hög profil på minst 38 mm (1,5 in) för körning i djup snö.• Användning på tunt snöfall, is, hårdpackad snö, jord o.s.v. resulterar i snabb förlitning eller skada på drivband och glidskenor.
MUISTA
<ul style="list-style-type: none">• Tässä moottorikelkassa on vakiovarusteena yli 38 mm (1,5 in) korkeaprofiilinen telamatto, joka on tarkoitettu syvässä lumessa ajoon.• Käyttö vähäisessä lumessa, jäällä, kovalla hangella, likaisilla pinnoilla jne. vahingoittaa raidetta tai sivuraiteita ja aiheuttaa niiden nopean kulumisen.

8JJ-2815M-S0

7

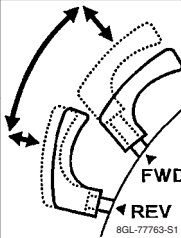
INSTRUKTIONER FÖR VÄXLING • Växla bara när maskinen stoppats och motorn går på tomgång. • Dra ut växelspaken och flytta den till läget framåt (FWD) eller back (REV) tills det tar stopp. Tryck in växelspaken.	
VAIHTEN VAIHTO-OHJEET • Vaihda vaihdetta vain, kun moottorikelkka on pysäytetty ja moottori käy joutokäyntiä. • Vedä vaihdevipu esilin, siirrä sitä eteenpäin ajovaliteelle (FWD) tai taaksepäin peruutusvaihteelle (REV), kunnes sen liike pysähtyy. Paina vaihdevipu sisään.	

8 FX10XT/FX10XT75/FX10M53S/FX10M62S

⚠ VARNING	⚠ VAROITUS
INGA PASSAGERARE ELLER ANNAN LAST PÅ DENNA SKYDDSKÅPA. Ej avsedd för last. Om den belastas kan den deformeras. Placera ingenting på skyddskåpan då baklyktan kan skymmas och detta i sin tur kan leda till olyckor.	TÄMÄN TELAMATONSUOJUKSEN PÄÄLLÄ EI SAA KULJETTAA MATKUSTAJIA EIKÄ TAVARAA. Sitä ei ole suunniteltu kestämaan painoa. Kuormitettuna se voi taipua tai murtua. Tähän laitettu esine voi estää jarru- ja takavalon näkymisen. Valojen peittyminen voi aiheuttaa onnettomuuden.

8HA-77762-S0

9

 2012 YAMAHA MOTOR CO., LTD. 2500 SHINGAI, IWATA, JAPAN
--

8AC-2817L-00

Location of the important labels

10 FX10RTRS

RFX10RSS	
94.2 kW	272 kg
<small>8HK-2156A-20</small>	

10 FX10XT

RFX10ST2	
94.2 kW	278 kg
<small>8HL-2156A-30</small>	

10 FX10XT75

RFX10ST2S	
94.2 kW	283 kg
<small>8JJ-2156A-00</small>	

10 FX10M53S

RFX10RMS2	
94.2 kW	278 kg
<small>8HU-2156A-10</small>	

10 FX10M62S

RFX10RMS	
94.2 kW	279 kg
<small>8HR-2156A-20</small>	

FX10RTRS

11

⚠ WARNING
<p>This unit contains high pressure nitrogen gas. Mishandling can cause explosion.</p> <ul style="list-style-type: none"> • Read owner's manual for instructions. • Do not incinerate, puncture or open.



⚠ AVERTISSEMENT	⚠ 警告
<p>Cette unité contient de l'azote à haute pression. Une mauvaise manipulation peut entraîner d'explosion.</p> <ul style="list-style-type: none"> • Voir le manuel d'utilisateur pour les instructions. • Ne pas brûler ni perforer ni ouvrir. 	<p>高圧窒素ガス入りです。取扱いを誤ると爆発する恐れがあります。</p> <ul style="list-style-type: none"> • 取扱説明書をよく読んでください。 • 火中への投入、孔あけ、分解はしないでください。

BGT-22259-50

12



4AA-22259-40

FX10XT/FX10XT75

11,12



4AA-22259-40

Location of the important labels

FX10M53S/FX10M62S

11

⚠ WARNING
<p>This unit contains high pressure nitrogen gas. Mishandling can cause explosion.</p> <ul style="list-style-type: none"> • Read owner's manual for instructions. • Do not incinerate, puncture or open.



⚠ AVERTISSEMENT	⚠ 警告
<p>Cette unité contient de l'azote à haute pression. Une mauvaise manipulation peut entraîner d'explosion.</p> <ul style="list-style-type: none"> • Voir le manuel d'utilisateur pour les instructions. • Ne pas brûler ni perforez ni ouvrir. 	<p>高圧窒素ガス入りです。取扱いを誤ると爆発する恐れがあります。</p> <ul style="list-style-type: none"> • 取扱説明書をよく読んでください。 • 火中への投入、孔あけ、分解はしないでください。

BHR-22259-00

12

⚠ 警告	⚠ AVERTISSEMENT
<ul style="list-style-type: none"> • 火中への投入、孔あけ、分解はしないでください。 • 取扱説明書をよく読んでください。 • 取扱いを誤ると爆発する恐れがあります。 <p>高圧窒素ガス入りです。</p>	<ul style="list-style-type: none"> • Ne pas brûler ni perforez ni ouvrir. • Voir le manuel d'utilisateur pour les instructions. • Une mauvaise manipulation peut entraîner d'explosion. <p>Cette unité contient de l'azote à haute pression.</p>

⚠ WARNING
<p>This unit contains high pressure nitrogen gas. Mishandling can cause explosion.</p> <ul style="list-style-type: none"> • Read owner's manual for instructions. • Do not incinerate, puncture or open.



BHR-22259-10

⚠ WARNING
<p>This unit contains high pressure nitrogen gas. Mishandling can cause explosion.</p> <ul style="list-style-type: none"> • Read owner's manual for instructions. • Do not incinerate, puncture or open.







⚠ 警告	⚠ AVERTISSEMENT
<ul style="list-style-type: none"> • 火中への投入、孔あけ、分解はしないでください。 • 取扱説明書をよく読んでください。 • 取扱いを誤ると爆発する恐れがあります。 <p>高圧窒素ガス入りです。</p>	<ul style="list-style-type: none"> • Ne pas brûler ni perforez ni ouvrir. • Voir le manuel d'utilisateur pour les instructions. • Une mauvaise manipulation peut entraîner une explosion. <p>Cette unité contient de l'azote sous haute pression.</p>

BHR-22259-40

Location of the important labels

Familiarize yourself with the following pictograms and read the explanatory text.

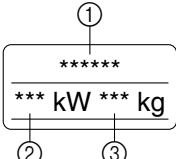
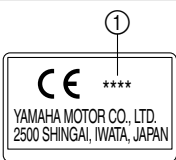
	Read the Owner's manual.
	This unit contains high-pressure nitrogen gas. Mishandling can cause an explosion. Do not incinerate, puncture or open.
	This pictogram shows the sled hitch tow weight limit (combined weight of the sled and all cargo in the sled). Overloading can cause loss of control. Loss of control can result in severe injury or death.
	This pictogram shows the sled hitch tongue weight limit (weight on the sled tongue). Overloading can cause loss of control. Loss of control can result in severe injury or death.
	<ul style="list-style-type: none">① Model Name② Max. Power③ Mass In Running Order
	<ul style="list-style-type: none">① Year of construction

Location of the important labels

For RUSSIA

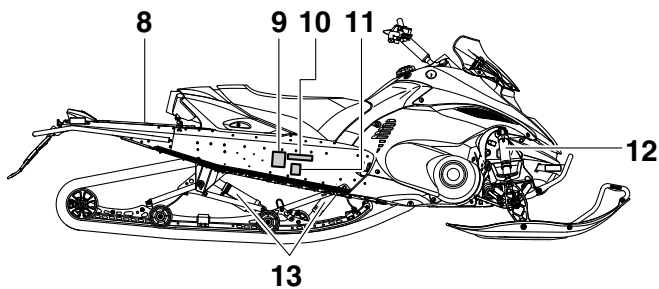
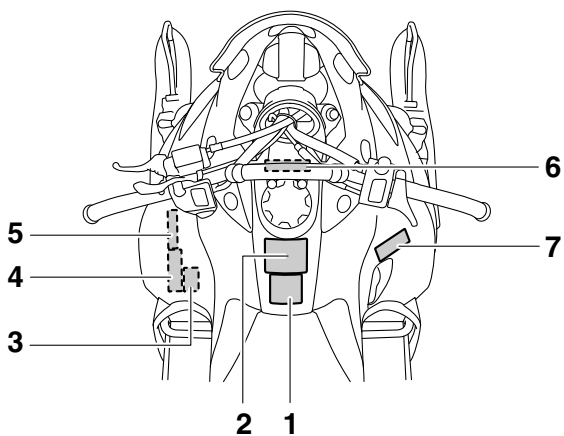

Location of the important labels

1 FX10M62S

⚠ ОСТОРОЖНО

Неправильное пользование закрепленным на руле ремнем, может стать причиной ТЯЖЕЛОЙ ТРАВМЫ или СМЕРТИ.

- Используйте ремень только как предмет, за который может держаться водитель для смещения веса тела по направлению к вершине холма с целью сохранения равновесия при пересечении склона.
- Одна рука должна оставаться на руле. Не изменяйте резко скорость и направление.
- Пересекать склоны такой крутизны, при которой необходимо пользоваться ремнем, должны только опытные водители.

8FN-77761-R1

2

⚠ ОСТОРОЖНО

НЕВЫПОЛНЕНИЕ ВАМИ ЛЮБОГО ИЗ НИЖЕПЕРЕЧИСЛЕННЫХ ТРЕБОВАНИЙ МОЖЕТ ПРИВЕСТИ К СЕРЬЕЗНОЙ ТРАВМЕ ИЛИ СМЕРТИ :

- Перед эксплуатацией данного транспортного средства прочтите руководство пользователя и все предупреждения и надписи. Данный снегоход превосходит собой транспортное средство обладающее высокими эксплуатационными характеристиками. Им должны управлять опытные водители.
- Перед запуском двигателя проверьте на работоспособность дроссельную заслонку, тормоз и механизм рулевого управления.
- Прежде, чем пытаться запустить двигатель, включите стояночный тормоз. Ни в коем случае не едите на снегоходе с включенным стояночным тормозом.
- Для выключения двигателя в экстренной ситуации нажмите на выключатель двигателя.
- Не включайте двигатель без приводного ремня или кожуха привода.
- После заправки топливом убедитесь, что крышка топливного бака плотно закрыта.
- Не едите на снегоходе по дорогам общественного пользования. Это может привести к столкновению с другим транспортным средством.
- Перед поездкой на снегоходе надевайте надлежащие средства защиты : шлем, защитные очки (щиток) и защитную одежду.
- Перед началом движения проверьте положение рычага (Передний ход или Задний ход).

8GL-77761-R0

3

⚠ ОСТОРОЖНО

НЕ ВКЛЮЧАЙТЕ ДВИГАТЕЛЬ БЕЗ КЛИНОВОГО РЕМНЯ ИЛИ КОЖУХА ПРИВОДА.

8AC-77762-R1

4 FX10XT75

TUNE-UP SPECIFICATIONS

DRIVE

1. CHAIN CASE OIL QTY 200 cm³ (6.8 oz)
2. CHAIN CASE OIL TYPE GL-3 75W or 80W
3. TRACK TENSION 30 - 35 mm (1.18 - 1.38 in)/100 N (10 kg, 22 lb).

- * FOR MORE INFO: SEE SERVICE MANUAL FOR THIS MODEL.
- * SPECIFICATIONS SUBJECT TO CHANGE WITHOUT NOTICE.

SPECIFICATIONS DE LA MISE AU POINT

ENTRAÎNEMENT

1. CAPACITÉ D'HUILE DU CARTER DE CHAÎNE 200 cm³
2. TYPE D'HUILE DU CARTER DE CHAÎNE GL-3 75W or 80W
3. FLÈCHE DE LA CHENILLE 30 - 35 mm/100 N (10 kg)

- * POUR PLUS DE DÉTAIL: VOIR LE MANUEL D'ATELIER POUR CE MODÈLE.
- * LES CARACTÉRISTIQUE TECHNIQUES SONT SUSCEPTIBLES DE CHANGER SANS NOTIFICATION PRÉALABLE.

8HA-47578-00

4 FX10XT

TUNE-UP SPECIFICATIONS

DRIVE

1. CHAIN CASE OIL QTY 200 cm³ (6.8 oz)
2. CHAIN CASE OIL TYPE GL-3 75W or 80W
3. TRACK TENSION 25 - 30 mm (0.98 - 1.18 in)/100 N (10 kg, 22 lb).

- * FOR MORE INFO: SEE SERVICE MANUAL FOR THIS MODEL.
- * SPECIFICATIONS SUBJECT TO CHANGE WITHOUT NOTICE.

SPECIFICATIONS DE LA MISE AU POINT

ENTRAÎNEMENT

1. CAPACITÉ D'HUILE DU CARTER DE CHAÎNE 200 cm³
2. TYPE D'HUILE DU CARTER DE CHAÎNE GL-3 75W or 80W
3. FLÈCHE DE LA CHENILLE 25 - 30 mm/100 N (10 kg)

- * POUR PLUS DE DÉTAIL: VOIR LE MANUEL D'ATELIER POUR CE MODÈLE.
- * LES CARACTÉRISTIQUE TECHNIQUES SONT SUSCEPTIBLES DE CHANGER SANS NOTIFICATION PRÉALABLE.

8GL-47578-00

4 FX10M62S

TUNE-UP SPECIFICATIONS

DRIVE

1. CHAIN CASE OIL QTY 200 cm³ (6.8 oz)
2. CHAIN CASE OIL TYPE GL-3 75W or 80W
3. TRACK TENSION 40 - 45 mm (1.57 - 1.77 in)/100 N (10 kg, 22 lb).

- * FOR MORE INFO: SEE SERVICE MANUAL FOR THIS MODEL.
- * SPECIFICATIONS SUBJECT TO CHANGE WITHOUT NOTICE.

SPECIFICATIONS DE LA MISE AU POINT

ENTRAÎNEMENT

1. CAPACITÉ D'HUILE DU CARTER DE CHAÎNE 200 cm³
2. TYPE D'HUILE DU CARTER DE CHAÎNE GL-3 75W or 80W
3. FLÈCHE DE LA CHENILLE 40 - 45 mm/100 N (10 kg)

- * POUR PLUS DE DÉTAIL: VOIR LE MANUEL D'ATELIER POUR CE MODÈLE.
- * LES CARACTÉRISTIQUE TECHNIQUES SONT SUSCEPTIBLES DE CHANGER SANS NOTIFICATION PRÉALABLE.

8HR-47578-00

Location of the important labels

5

TUNE-UP SPECIFICATIONS	SPECIFICATIONS DE LA MISE AU POINT ^{8GL}
ENGINE	MOTEUR
1.SPARK PLUG <u>CR9E(NGK)</u>	1.TYPE DE BOUGIE <u>CR9E(NGK)</u>
2.SPARK PLUG GAP <u>0.7 ~ 0.8 mm (0.028 ~ 0.031 in)</u>	2.ECARTEMENT DES ÉLECTRODES <u>0.7 ~ 0.8 mm</u>
4.IDLE SPEED <u>1500 ± 50 r/min</u>	3.RÉGIME DE RALENTI <u>1500 ± 50 r/min</u>

8GL-1417E-00

6 FX10XT75/FX10M62S

VIKTIGT

- Snöskotern är originalutrustad med ett spårmonster med hög profil på minst 38 mm (1,5 in) för körning i djup snö.
- Användning på tunt snöfall, is, hårdpackad snö, jord o.s.v. resulterar i snabb förlitning eller skada på drivband och glidskenor.

MUISTA

- Tässä moottorikelkassa on vakiovarusteena yli 38 mm (1,5 in) korkeaprofiilinen telamatto, joka on tarkoitettu syvässä lumessa ajoon.
- Käyttö vähäisessä lumessa, jäällä, kovalla hangella, likaisilla pinnoilla jne. vahingoittaa raidetta tai sivuraitteita ja aiheuttaa niiden nopean kulumisen.

8JJ-2815M-S0

7

INSTRUKTIONER FÖR VÄXLING

- Växla bara när maskinen stoppats och motorn går på tomgång.
- Dra ut växelspaken och flytta den till läget framåt (FWD) eller back (REV) tills det tar stopp. Tryck in växelspaken.

VAIHTEEN VAIHTO-OHJEET

- Vaihda vaihdetta vain, kun moottorikelkka on pysäytetty ja moottori käy joutokäyntiä.
- Vedä vaihdevipu esin, siirrä sitä eteenpäin ajovaihteelle (FWD) tai taaksepäin peruutuvaihteelle (REV), kunnes sen liike pysähtyy. Paina vaihdevipu sisään.

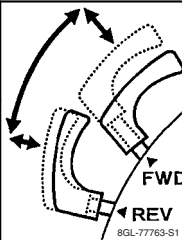

8

⚠ ОСТОРОЖНО

ЗАПРЕЩАЕТСЯ ПЕРЕВОЗИТЬ ЛЮДЕЙ ИЛИ ГРУЗЫ НА КОЖУХЕ ГУСЕНИЦЫ.

Не предназначено для перевозки тяжестей.

Может прогнуться или сломаться под нагрузкой.

Размещение чего-либо в этом месте загроживает сигнал торможения/задний фонарь, что может привести к несчастному случаю.

8HA-77762-R0

9

CE 2012

YAMAHA MOTOR CO., LTD.
2500 SHINGAI, IWATA, JAPAN

8AC-2817L-00

Location of the important labels

10 FX10XT

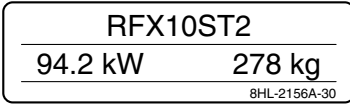

10 FX10XT75



10 FX10M62S

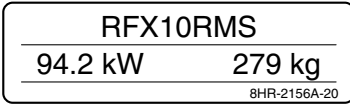

11

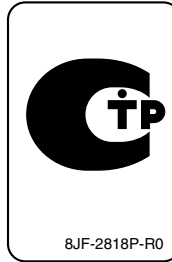

FX10XT/FX10XT75 12,13



Location of the important labels

FX10M62S

12

⚠ WARNING
<p>This unit contains high pressure nitrogen gas. Mishandling can cause explosion.</p> <ul style="list-style-type: none"> • Read owner's manual for instructions. • Do not incinerate, puncture or open.



⚠ AVERTISSEMENT	⚠ 警告
<p>Cette unité contient de l'azote à haute pression. Une mauvaise manipulation peut entraîner d'explosion.</p> <ul style="list-style-type: none"> • Voir le manuel d'utilisateur pour les instructions. • Ne pas brûler ni perforer ni ouvrir. 	<p>高圧窒素ガス入りです。取扱いを誤ると爆発する恐れがあります。</p> <ul style="list-style-type: none"> • 取扱説明書をよく読んでください。 • 火中への投入、孔あけ、分解はしないでください。

BHR-22259-00

13

⚠ 警告	⚠ AVERTISSEMENT
<ul style="list-style-type: none"> • 火中への投入、孔あけ、分解はしないでください。 • 取扱説明書をよく読んでください。 • 取扱いを誤ると爆発する恐れがあります。 <p>高圧窒素ガス入りです。</p>	<ul style="list-style-type: none"> • Ne pas brûler ni perforer ni ouvrir. • Voir le manuel d'utilisateur pour les instructions. • Une mauvaise manipulation peut entraîner d'explosion. <p>Cette unité contient de l'azote à haute pression.</p>

⚠ WARNING
<p>This unit contains high pressure nitrogen gas. Mishandling can cause explosion.</p> <ul style="list-style-type: none"> • Read owner's manual for instructions. • Do not incinerate, puncture or open.



BHR-22259-10

⚠ WARNING
<p>This unit contains high pressure nitrogen gas. Mishandling can cause explosion.</p> <ul style="list-style-type: none"> • Read owner's manual for instructions. • Do not incinerate, puncture or open.



⚠ 警告	⚠ AVERTISSEMENT
<ul style="list-style-type: none"> • 火中への投入、孔あけ、分解はしないでください。 • 取扱説明書をよく読んでください。 • 取扱いを誤ると爆発する恐れがあります。 <p>高圧窒素ガス入りです。</p>	<ul style="list-style-type: none"> • Ne pas brûler ni perforer ni ouvrir. • Voir le manuel d'utilisateur pour les instructions. • Une mauvaise manipulation peut entraîner une explosion. <p>Cette unité contient de l'azote sous haute pression.</p>

BHR-22259-40

Safety information

ESU10183

As the vehicle's owner, you are responsible for the safe and proper operation of your snowmobile. When you ride your snowmobile, you must know and use the following for your safety. Severe injury or death may result if you ignore any of the following.

Before you operate your snowmobile

- Read the Owner's Manual and all labels. Become familiar with all of the operating controls and their function. Consult a Yamaha dealer about any control or function you do not understand.
- Wear protective clothing. Wear an approved helmet, and a face shield or goggles. Also, wear a good quality snowmobile suit, boots, and a pair of gloves or mittens that will permit use of your thumbs and fingers for operation of the controls.



- Do not operate the snowmobile after or while drinking alcohol or taking drugs. Your ability to operate the snowmobile is reduced by the influence of alcohol or drugs.

Prepare your snowmobile

- Perform the pre-operation checks each time you use the vehicle to make sure it is in safe operating condition. Failure to inspect or maintain the vehicle properly in-

creases the possibility of an accident or equipment damage. See page 48 for a list of pre-operation checks.

- Apply the parking brake before starting the engine. Never drive the snowmobile with the parking brake applied. This may overheat the brake disc and reduce braking ability.

While using your snowmobile

- This snowmobile was not manufactured for use on public streets, roads, or highways. Such use is prohibited by law, and you could collide with another vehicle.
- This snowmobile is designed to carry the OPERATOR ONLY. Passengers are prohibited. Carrying a passenger can cause loss of control.

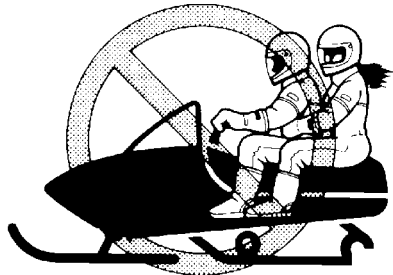

- Be careful where you ride. There may be obstacles hidden beneath the snow. Stay on established trails to minimize your exposure to hazards. Ride slowly and cautiously when you ride off of established trails. Hitting a rock or stump, or running into wires could cause an accident and injury.
- This snowmobile is not designed for use on surfaces other than snow or ice. Use on dirt, sand, grass, rocks, or bare pavement may cause loss of control and may damage the snowmobile.

- Always ride with other snowmobilers when going on a ride. You may need help if you run out of fuel, have an accident, or damage your snowmobile.
- Many surfaces such as ice and hardpacked snow require much longer stopping distances. Be alert, plan ahead and begin decelerating early. The best braking method on most surfaces is to release the throttle and apply the brake gently—not suddenly.

Avoid carbon monoxide poisoning

All engine exhaust contains carbon monoxide, a deadly gas. Breathing carbon monoxide can cause headaches, dizziness, drowsiness, nausea, confusion, and eventually death. Carbon monoxide is a colorless, odorless, tasteless gas which may be present even if you do not see or smell any engine exhaust. Deadly levels of carbon monoxide can collect rapidly and you can quickly be overcome and be unable to save yourself. Also, deadly levels of carbon monoxide can linger for hours or days in enclosed or poorly-ventilated areas. If you experience any symptoms of carbon monoxide poisoning, leave the area immediately, get fresh air, and **SEEK MEDICAL TREATMENT**.

- Do not run the engine indoors. Even if you try to ventilate engine exhaust with fans or open windows and doors, carbon monoxide can rapidly reach dangerous levels.
- Do not run the engine in poorly ventilated or partially enclosed areas such as barns, garages, or carports.
- Do not run the engine outdoors where engine exhaust can be drawn into a building through openings such as windows and doors.

Genuine Yamaha Accessories

Choosing accessories for your snowmobile is an important decision. Genuine Yamaha Accessories, which are available only from a Yamaha dealer, have been designed, tested, and approved by Yamaha for use on your snowmobile. Many companies with no connection to Yamaha manufacture parts and accessories or offer other modifications for Yamaha vehicles. Yamaha is not in a position to test the products that these aftermarket companies produce. Therefore, Yamaha can neither endorse nor recommend the use of accessories not sold by Yamaha or modifications not specifically recommended by Yamaha, even if sold and installed by a Yamaha dealer.

Maintenance and storage

- When laying the snowmobile on its side for maintenance, use a suitable stand to keep it in a stable and level position.
- Do not leave the snowmobile on its left side for an extended period of time. Fuel may leak out from the fuel breather hose.
- Do not allow anyone to stand behind the snowmobile when starting, inspecting, or adjusting the snowmobile. A broken track, track fittings, or debris thrown by the track could be dangerous to the operator or bystanders.
- Modifications made to the snowmobile not approved by Yamaha, or the removal of original equipment may render your snowmobile unsafe for use, which may cause severe personal injury. Modifications may also make the snowmobile illegal to use.
- Never store the snowmobile with fuel in the fuel tank inside a building where ignition sources are present such as hot water and space heaters, an open flame, sparks,

Safety information

clothes dryers, and the like. Allow the engine to cool off before storing the snowmobile in an enclosed space.

ESU10261

FX10

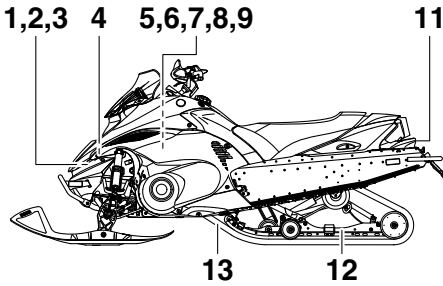

FX10RTRS

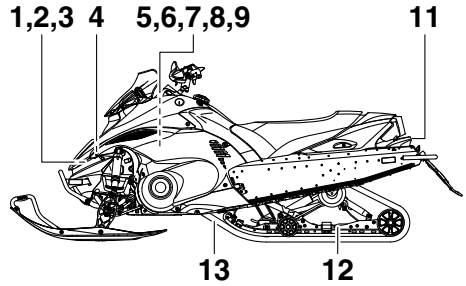

FX10M53S/FX10M62S

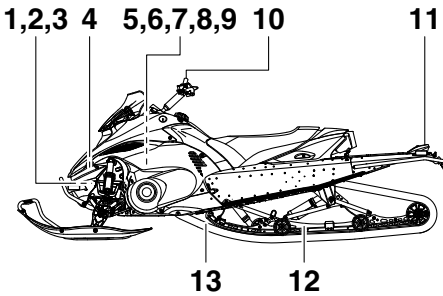

FX10XT/FX10XT75

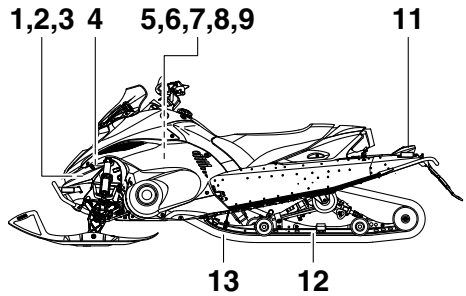

1. Storage pouch
2. Tool kit
3. Coolant reservoir
4. Air filter
5. Battery
6. Main fuse
7. Fuel injection system fuse
8. Oil filler cap
9. Fuse box

10. Strap (FX10M53S/FX10M62S)
11. Tail/brake light
12. Slide rail suspension
13. Drive track

Description

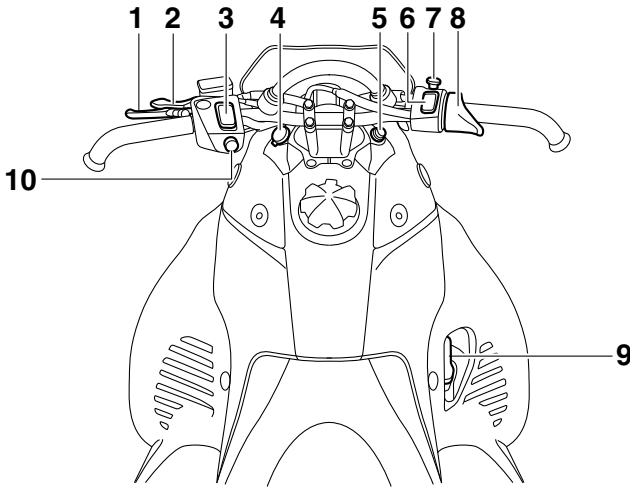

- | | |
|--|---------------------------|
| 1. Brake lever | 7. Engine stop switch |
| 2. Parking brake lever | 8. Throttle lever |
| 3. Grip warmer adjusting switch | 9. Shift lever |
| 4. Auxiliary DC jack (FX10M53S/FX10M62S) | 10. Headlight beam switch |
| 5. Main switch | |
| 6. Thumb warmer adjusting switch | |

TIP

- The snowmobile you have purchased may differ slightly from those shown in the figures of this manual.
 - Design and specifications are subjected to change without notice.
-

ESU10292

Main switch

The main switch controls the ignition and lighting systems. The various positions are described below.

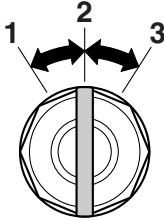

1. Off
2. On
3. Start

Off

The ignition circuit is switched off.
The key can be removed only in this position.

On

The ignition circuit is switched on.

Start

The starting circuit is switched on.
The starter motor cranks the engine.
NOTICE: Release the switch immediately after the engine starts. [ECS00021]

TIP

The headlights and taillight come on after the engine is started.

ESU10312

Throttle lever

Once the engine is running cleanly, squeezing the throttle lever will increase the engine speed and cause engagement of the drive train. Regulate the speed of the snowmobile by varying the throttle position. Because the

throttle is spring-loaded, the snowmobile will decelerate, and the engine will return to idle when it is released.

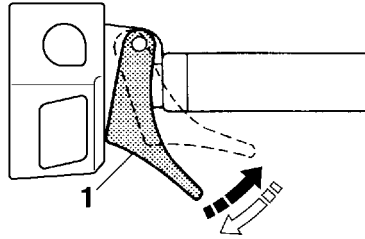

1. Throttle lever

ESU10347

Throttle override system (T.O.R.S.)

EWS00041



WARNING

If the T.O.R.S. is activated, make sure that the cause of the malfunction has been corrected and that the engine can be operated without a problem before restarting the engine. Continuing to operate with a malfunction could cause loss of control or damage.

If the throttle valves or throttle cable malfunctions during operation, the T.O.R.S. will be activated when the throttle lever is released.

The T.O.R.S. is designed to override the fuel injection and limit the engine speed to less than the clutch engagement speed if the throttle valves fail to return to the idle position when the throttle lever is released. (See page 98 for the clutch engagement speed.)

Control functions

	Idling	Riding	Malfunction
Throttle lever	Released	Squeezed	Released
Throttle valve	Closed	Open	Open
T.O.R.S.	Engine runs properly.	Engine runs properly.	T.O.R.S. will be activated.

TIP

If the T.O.R.S. is activated, the warning light and engine trouble warning indicator will flash, and the two-digit code “84” will flash in the meter display. If this occurs, have a Yamaha dealer check the system as soon as possible.

- indicator lights (which show high beam and low coolant temperature conditions)
- a warning light (which shows warnings together with the warning indicators)
- a fuel meter (which shows the fuel remaining in the fuel tank)
- a grip/thumb warmer level indicator (which shows the grip warmer or the thumb warmer level)

When the key is turned to the on position, the warning light, the low coolant temperature indicator light, and all segments of the meter display come on and go off.

The grip warmer level is initially displayed for 5 seconds, then the display switches to the fuel meter.

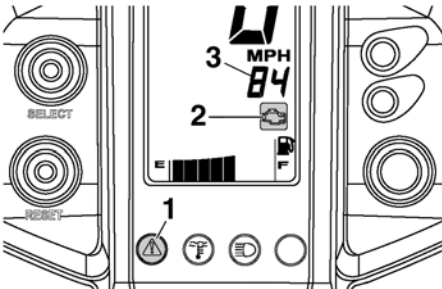

1. Warning light “”
2. Engine trouble warning indicator “”
3. Two-digit code “84”

ESU12726

Multi-function meter unit

The multi-function meter unit is equipped with the following:

- a digital speedometer
- an odometer
- a tripmeter (which shows the distance traveled since it was last set to zero)
- an engine speed meter (which shows the engine speed; not for use while riding)
- warning indicators (which show engine trouble, coolant temperature, fuel level, oil level, and oil pressure warnings)

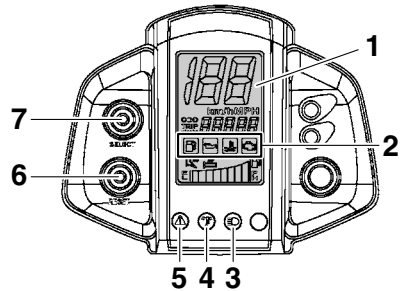

1. Meter display
2. Warning indicators
3. High beam indicator light “”
4. Low coolant temperature indicator light “”
5. Warning light “”
6. “RESET” button
7. “SELECT” button

Odometer, tripmeter, and engine speed meter modes

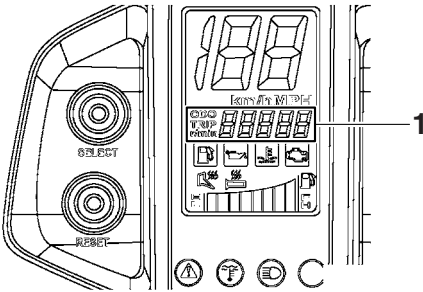

1. Odometer/tripmeter/engine speed meter

Pushing the “SELECT” button switches the display between the odometer mode “ODO”, tripmeter mode “TRIP”, and engine speed meter mode “r/min” in the following order:

ODO → TRIP → r/min → ODO

To reset the tripmeter, push the “RESET” button for at least 1 second while the tripmeter is displayed.

TIP

- To switch the speedometer, odometer, and tripmeter displays between kilometers and miles, select the odometer mode “ODO”, and then push the “SELECT” button for at least 10 seconds while the snowmobile is stopped.
- Use the engine speed meter only when checking the snowmobile and performing basic maintenance. The engine speed meter should not be used while riding the snowmobile since the reading will vary from the actual engine speed.

ESU10411

High beam indicator light “ ”

The high beam indicator light comes on when the high beams of the headlights are switched on. (See page 27 for headlight beam switch operation.)

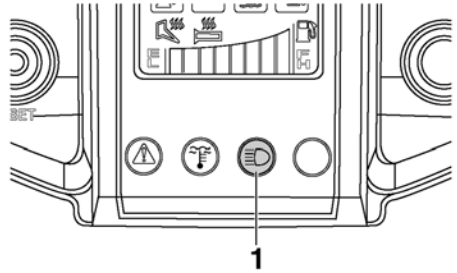

1. High beam indicator light “ ”

ESU10473

Low coolant temperature indicator light “ ”

The low coolant temperature indicator light comes on when the coolant temperature is low and informs the rider that the snowmobile should be warmed up. After the engine is started, warm it up until the indicator light goes off.

The snowmobile can be operated normally after the indicator light goes off.

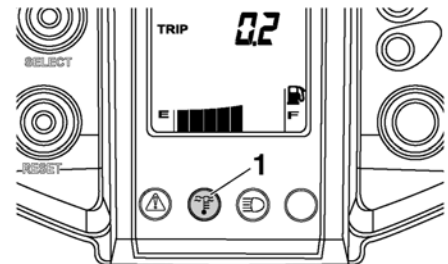

1. Low coolant temperature indicator light “ ”

TIP

Drive the snowmobile at low speeds when the low coolant temperature indicator light is on. If the engine speed is too high, maximum engine speed is reduced to protect the engine.

Control functions

ESU10427

Fuel meter and grip/thumb warmer level indicator

The fuel meter and grip/thumb warmer level indicator have eight segments which show the amount of fuel remaining in the fuel tank, the grip warmer level, or the thumb warmer level.

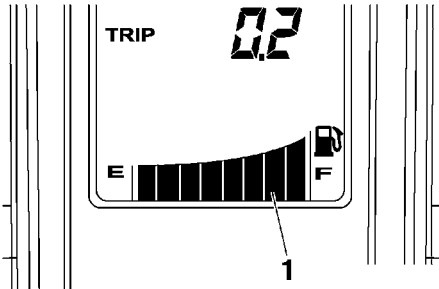

1. Fuel meter and grip/thumb warmer level indicator

Fuel meter

The display segments of the fuel meter disappear towards “E” (Empty) as the fuel level decreases. When only one segment is left near “E”, the fuel level warning indicator and the warning light come on.

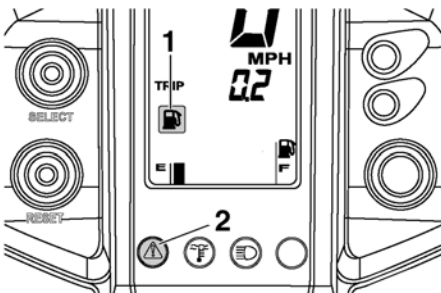

1. Fuel level warning indicator “

If the fuel level warning indicator and the warning light come on, refuel as soon as possible.

TIP

The snowmobile must be stopped on a level surface to obtain an accurate fuel meter reading, since the reading changes according to the movement and inclination of the snowmobile.

Grip/thumb warmer level indicator

When the grip warmer adjusting switch is pressed, the grip warmer indicator comes on and the display switches to the grip warmer level.

When the thumb warmer adjusting switch is pressed, the thumb warmer indicator comes on and the display switches to the thumb warmer level.

See “Grip/thumb warmer adjusting switch” on page 27 for detailed information.

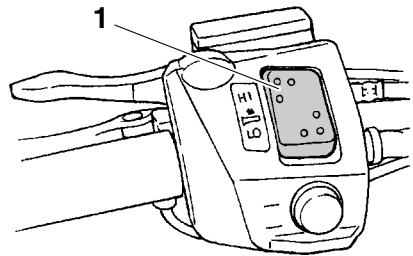

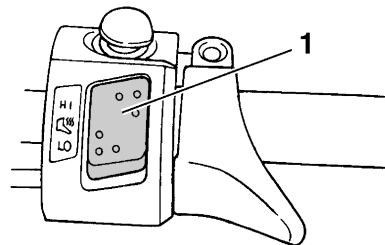

1. Grip warmer adjusting switch

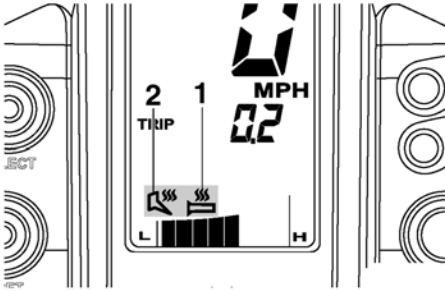

1. Thumb warmer adjusting switch

Control functions



1. Grip warmer indicator “”
2. Thumb warmer indicator “”

TIP

- The grip/thumb warmer level is displayed for 5 seconds after releasing the grip/thumb warmer adjusting switch, then the display switches to the fuel meter.
- The top segment of the grip/thumb warmer level indicator flashes once when the grip/thumb warmer adjustment reaches the maximum level. The bottom segment of the grip/thumb warmer level indicator flashes once when the grip/thumb warmer adjustment reaches the minimum level.
- When the engine is started, the grip/thumb warmer levels are set to the levels selected when the engine was last stopped.

ESU10455



Fuel level warning indicator “”

The fuel level warning indicator and the warning light come on when the fuel level is low. (See page 24 for details.)

The fuel level warning indicator, the warning light, and all segments of the fuel meter start to flash when a malfunctioning sensor, disconnected coupler, broken lead, or short circuit is detected by the self-diagnosis device of the snowmobile to warn the rider of any of the above problems.

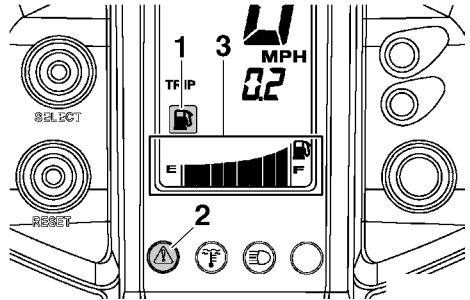
If the fuel level warning indicator, the warning light, and all segments of the fuel meter flash, have a Yamaha dealer inspect the snowmobile as soon as possible.



1. Fuel level warning indicator “”
2. Warning light “”
3. Fuel meter

ESU13991



Oil level/pressure warning indicator “”

The oil level/pressure warning indicator has two functions. The warning indicator comes on when the engine oil level is low and when the engine oil pressure is low. The functions are explained in the following sections.

Oil level warning

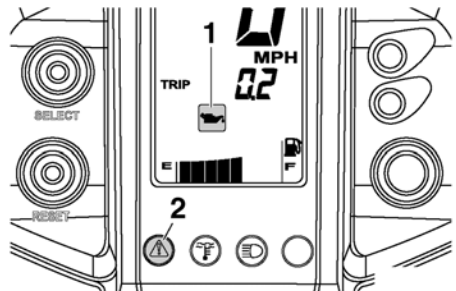
The warning indicator and the warning light come on when the engine oil level is low.



1. Oil level/pressure warning indicator “”
2. Warning light “”

Control functions

If the warning indicator and the warning light come on, place the snowmobile on a level surface and allow it to idle for one minute.

If the warning indicator and the warning light go off, the engine oil level is sufficient, however it is getting low. Add engine oil as soon as possible.

If the warning indicator and the warning light do not go off, check the engine oil level in the oil tank (see page 69 for engine oil level checking procedures), and add engine oil if necessary.

If the warning indicator and the warning light still remain on, have a Yamaha dealer check the snowmobile.

Oil pressure warning

The warning indicator comes on and “OP-LO” (oil pressure low) appears in the odometer display if the engine oil pressure is low when the engine is started. At the same time, the engine speed is limited to less than the clutch engagement speed until the warning indicator goes off.

If the engine oil pressure remains low for one minute, the engine stops. If this occurs, have a Yamaha dealer check the snowmobile.

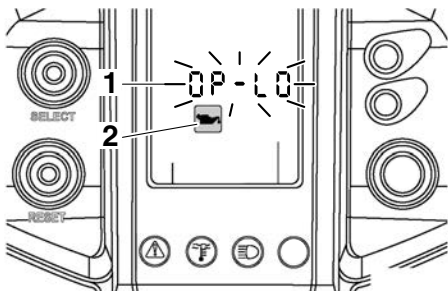

1. “OP-LO” (oil pressure low)
2. Oil level/pressure warning indicator “”

TIP



If there is no engine oil in the oil passages when the engine is started, such as after the engine oil is changed, the warning indicator may come on and “OP-LO” may appear in the odometer display for a few seconds until the oil circulates through the engine. The snowmobile can be operated normally after the warning indicator goes off.

ESU10513

Coolant temperature warning indicator “”

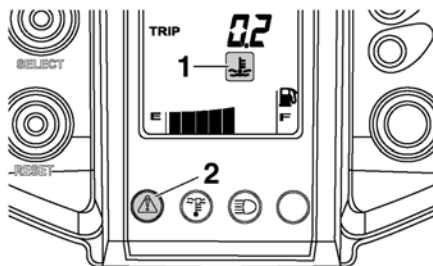
If the engine overheats, the coolant temperature warning indicator and the warning light come on. When this occurs, stop the engine immediately and allow the engine to cool down, and then check the coolant level in the coolant reservoir. (See page 74 for checking procedures.)



1. Coolant temperature warning indicator “”
2. Warning light “”

ECS00041

NOTICE

Do not continue to operate the engine if it is overheating.

ESU12686

Self-diagnosis device

This model is equipped with a self-diagnosis device for various electrical circuits.

Control functions

If a problem is detected in any of those circuits, the warning light and the engine trouble warning indicator flash, and an error code flashes slowly in the meter display. Note the error code, and then have a Yamaha dealer inspect the snowmobile as soon as possible. **NOTICE: Do not continue to operate the engine longer than necessary if there is an error code to avoid possible engine damage.** [ECS00820]

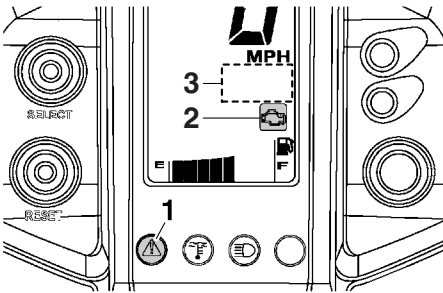

1. Warning light "△"
2. Engine trouble warning indicator "⚡"
3. Error code display

ESU10531

Engine stop switch "⊗"

The engine stop switch is used to stop the engine in an emergency. Simply push the stop switch to stop the engine. To start the engine, pull the stop switch and proceed with starting the engine. (See page 50 for engine starting procedures.)

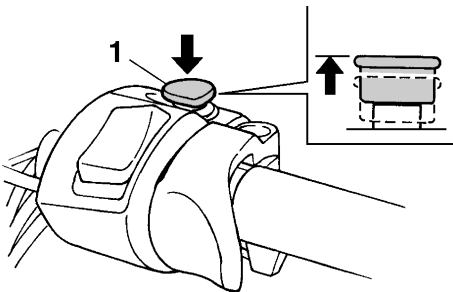

1. Engine stop switch "⊗"

During the first few rides, practice using the stop switch so that you can react quickly in an emergency.

ESU10661

Headlight beam switch "LIGHTS"

Push the headlight beam switch to change the headlight to high beam "HI" or to low beam "LO".

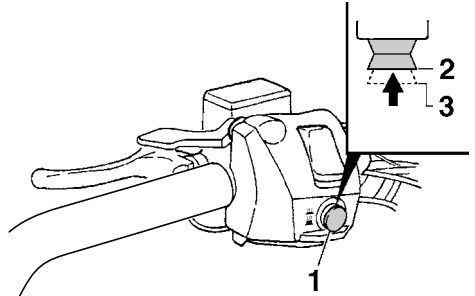

1. Headlight beam switch "LIGHTS"
2. High beam "HI"
3. Low beam "LO"

ESU12654

Grip/thumb warmer adjusting switch

The grip warmer adjusting switch and the thumb warmer adjusting switch control the electrically heated handlebar grips and throttle lever respectively.

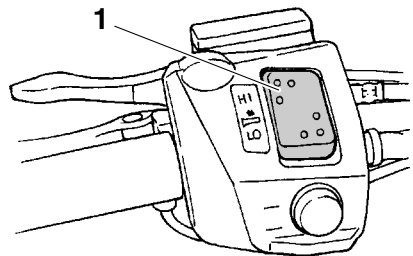

1. Grip warmer adjusting switch

Control functions

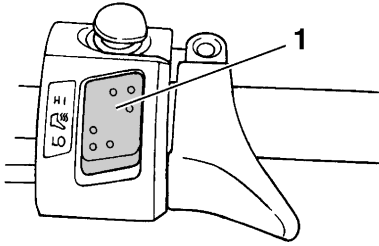

1. Thumb warmer adjusting switch

To raise the temperature

To raise the temperature, press the respective switch to “HI”.

To lower the temperature

To lower the temperature, press the respective switch to “LO”.

See “Fuel meter and grip/thumb warmer level indicator” on page 24 for detailed information.

ESU10696

Auxiliary DC jack (FX10M53S/FX10M62S)

The auxiliary DC jack is located in the front panel and can be used for accessories.

TIP

The auxiliary DC jack can only be used if the engine is running.

To use the auxiliary DC jack

1. Start the engine.
2. Open the auxiliary DC jack cap, and then insert the accessory power plug into the jack.

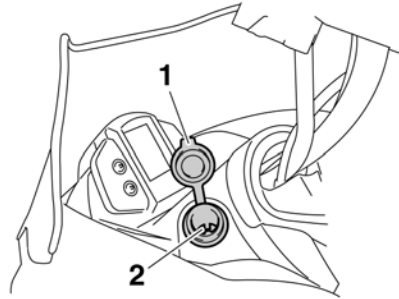

1. Auxiliary DC jack cap
2. Auxiliary DC jack
3. After using the auxiliary DC jack, be sure to remove the accessory power plug from the jack and to close the auxiliary DC jack cap.

ECS00122

NOTICE

- To avoid circuit overload and a possible fuse blowing, do not use accessories requiring more than the maximum rated capacity for the auxiliary DC jack. (See page 91 for the specified fuse amperage.)
- Do not use an automotive cigarette lighter or other accessory with a plug that gets hot because the jack can be damaged.

Maximum rated capacity:
DC 12 V, 2.5 A (30 W)

ESU14370

Brake lever

The snowmobile is stopped by braking the entire drive system.

Squeeze the brake lever towards the handlebar grip to stop the snowmobile.

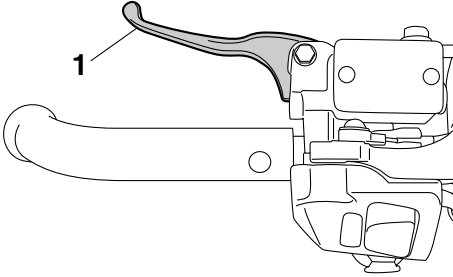

1. Brake lever

TIP

When the brake lever is squeezed, the brake light comes on.

ESU10581

Parking brake lever

When parking the snowmobile or starting the engine, apply the parking brake by moving the parking brake lever to the left.

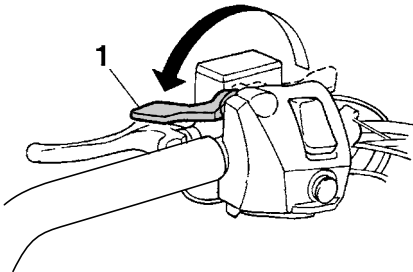

1. Parking brake lever

To release the parking brake, move the parking brake lever to the right.

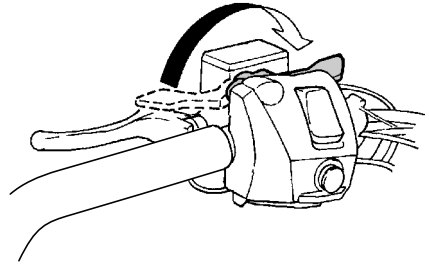

ESU13032

Shift lever

The shift lever is used to put the snowmobile into forward or reverse. Before shifting, wait for the snowmobile to come to a complete stop with the engine idling. Pull the shift lever out, slide it to “FWD” or to “REV” until it stops, and then push it back in.

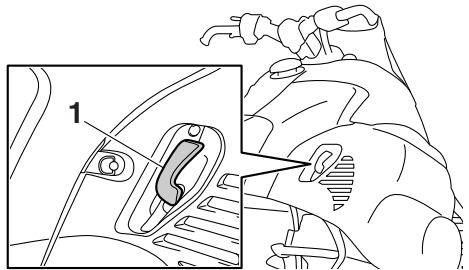

1. Shift lever

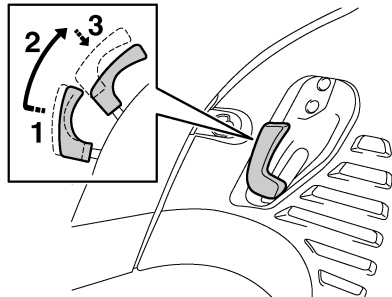

1. Pull out.
2. Slide to “FWD” (forward).
3. Push in.

Control functions

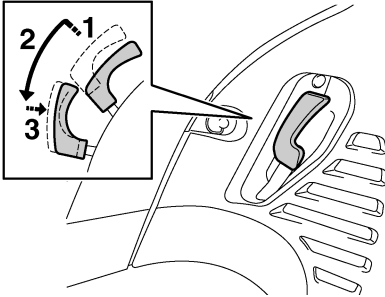

1. Pull out.
2. Slide to "REV" (reverse).
3. Push in.

ECS00072

NOTICE

Do not use the shift lever while the snowmobile is moving, otherwise the drive train could be damaged.

ESU12735

Drive guard

EWS00402

WARNING

- Coming in contact with the rotating V-belt or clutch parts can cause severe injury or death. Never run the engine with the drive guard removed.
- Make sure that the drive guard is installed securely before operating the snowmobile to protect against severe injury or death from a broken V-belt or other part should it come off the snowmobile while it is in operation.

ECS00830

NOTICE

Never run the engine with the V-belt removed. Clutch components can be damaged.

The drive guard is designed to protect the V-belt clutch and V-belt in case parts break or come loose.

The drive guard is located behind the left side cover. (See page 63 for removal procedures.)

To remove the drive guard

1. Pull out the drive guard locking pin from the drive guard rear holder.

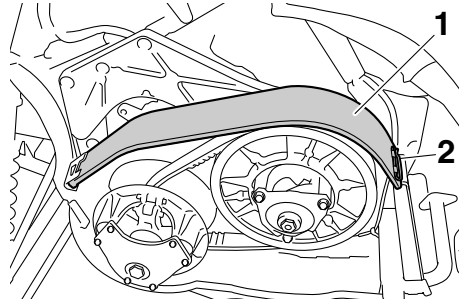

1. Drive guard
 2. Drive guard locking pin
2. Lift up the rear of the drive guard as shown, and then pull the guard rearward to remove it.

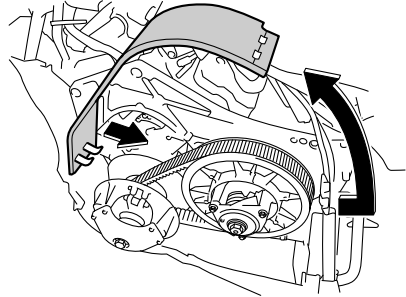

To install the drive guard

1. Fit the front slots in the drive guard over the projections on the drive guard front holder.

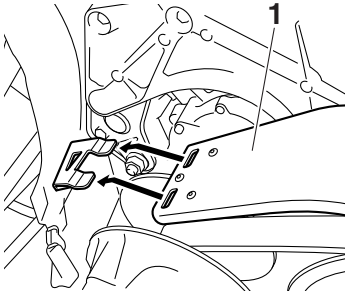

1. Drive guard
2. Align the slots in the rear of the drive guard with the projections on the drive guard rear holder, and then insert the drive guard locking pin into the holder as shown.

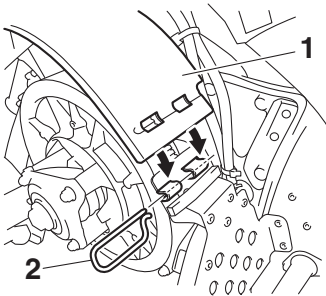

1. Drive guard
2. Drive guard locking pin

ESU13044

Storage pouch

The storage pouch is located under the shroud. (See page 63 for shroud removal procedures.) Use the storage pouch to store the tool kit, manuals, spare parts, such as the V-belt, or other small items.



1. Storage pouch

To remove the storage pouch

Unhook the swivel hook from the storage pouch bracket, and then pull out the storage pouch as shown.

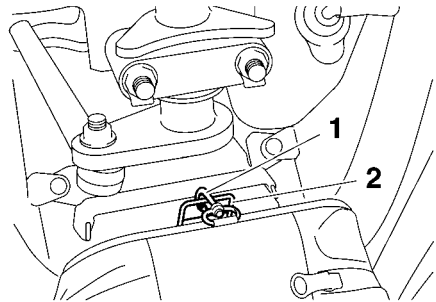

1. Swivel hook
2. Storage pouch bracket



To install the storage pouch

Place the storage pouch in the original position, and then hook the swivel hook onto the bracket.

Control functions

TIP

When installing the storage pouch, make sure that the swivel hook is securely hooked onto the bracket.

Storing the spare V-belt

Keep a spare V-belt for emergency use in the storage pouch.

TIP

When storing a spare V-belt in the storage pouch, be sure to secure it with the hook and loop fastener.

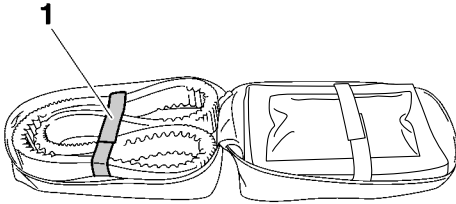

1. Hook and loop fastener

ESU10617

Fuel

EWS00071

WARNING

Gasoline and gasoline vapors are extremely flammable. To avoid fires and explosions and to reduce the risk of injury when refueling, follow these instructions.

Make sure there is sufficient gasoline in the tank.

1. Before refueling, turn off the engine and be sure that nobody is on the snowmobile. Never refuel while smoking, or while in the vicinity of sparks, open flames, or other sources of ignition such as the pilot lights of water heaters and clothes dryers.

2. Do not overfill the fuel tank. Stop filling when the fuel reaches the bottom of the filler tube. Because fuel expands when it heats up, heat from the engine or the sun can cause fuel to spill out of the fuel tank.

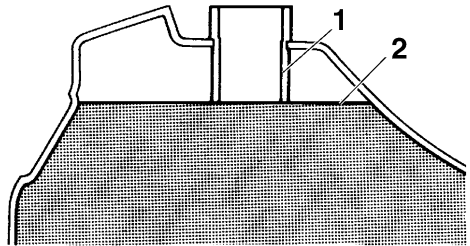
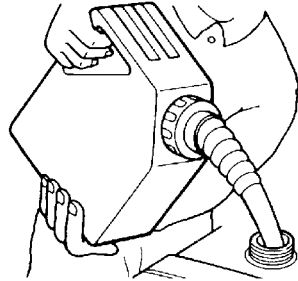

1. Filler tube
2. Maximum fuel level

3. Wipe up any spilled fuel immediately.
4. Be sure the fuel tank cap is closed securely by turning it clockwise.

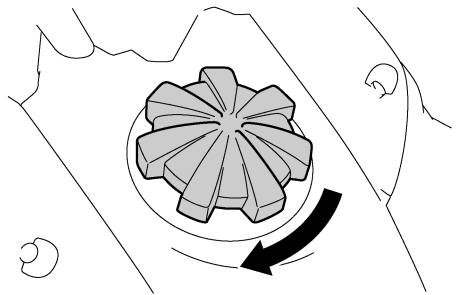

EWS00680



Gasoline is poisonous and can cause injury or death. Handle gasoline with care. Never siphon gasoline by mouth. If you should swallow some gasoline or inhale a lot of gasoline vapor, or get some gasoline in your eyes, see your doctor immediately. If gasoline spills on your skin, wash with soap and water. If gasoline spills on your clothing, change your clothes.

Recommended fuel:

FX10 REGULAR UNLEADED GASOLINE ONLY
FX10M53S Min 95 RON UNLEADED GASOLINE ONLY (FIN)(SWE)
FX10M53S REGULAR UNLEADED GASOLINE ONLY (CAN)
FX10M62S Min 91 RON UNLEADED GASOLINE ONLY (RUS)
FX10M62S Min 95 RON UNLEADED GASOLINE ONLY (FIN)(SWE)
FX10M62S REGULAR UNLEADED GASOLINE ONLY (CAN)
FX10RTRS Min 95 RON UNLEADED GASOLINE ONLY (FIN)(SWE)
FX10RTRS REGULAR UNLEADED GASOLINE ONLY (CAN)
FX10XT Min 91 RON UNLEADED GASOLINE ONLY (RUS)
FX10XT Min 95 RON UNLEADED GASOLINE ONLY (FIN)(SWE)
FX10XT REGULAR UNLEADED GASOLINE ONLY (CAN)
FX10XT75 Min 91 RON UNLEADED GASOLINE ONLY (RUS)
FX10XT75 Min 95 RON UNLEADED GASOLINE ONLY (FIN)(SWE)
FX10XT75 REGULAR UNLEADED GASOLINE ONLY (CAN)

Fuel tank capacity:

27.7 L (7.32 US gal, 6.09 Imp.gal)

Your Yamaha engine has been designed to use unleaded gasoline with a research octane number of 95 or higher. (For Canada and Russia, regular unleaded gasoline with a

pump octane number $[(R+M)/2]$ of 86 or higher, or a research octane number of 91 or higher.)

ECS00093

NOTICE

- Make sure that snow or ice does not enter the fuel tank when refueling.
- The fuel tank should be filled with the recommended gasoline. The use of other gasoline will cause severe damage to internal engine parts, such as the valves and piston rings, as well as to the exhaust system.

For CANADA

- Oxygenated fuels (gasohol) containing a maximum 10% of ethanol (E10) can be used, although richer jetting may be required to prevent engine damage. Consult a Yamaha dealer. Gasohol containing methanol is not recommended.
- Do not use alcohol deicers or water absorbing additives with oxygenated fuel.

ESU10874

Suspension

The suspension can be adjusted to suit rider preference. Softer settings, for example, may provide greater rider comfort, while harder settings may allow more precise handling and control over certain types of terrain or riding conditions.

If you are not familiar with suspension adjustments, have a Yamaha dealer make these adjustments.

EWS00151



Read and understand the following information before handling shock absorbers that contain highly pressurized nitrogen gas.

- Do not tamper with or attempt to open the cylinder assemblies.

Control functions

- Do not subject the shock absorbers to an open flame or other high heat source. This may cause the unit to explode due to excessive gas pressure.
- Do not deform or damage the cylinders in any way. Cylinder damage will result in poor damping performance.
- Do not dispose of a damaged or worn out shock absorber yourself. Take the shock absorber to a Yamaha dealer for any service.

ESU10894

Adjusting the spring preload of the front shock absorbers (FX10/FX10XT/FX10XT75)

EWS00720



WARNING

The spring preload of the left and right shock absorbers must be adjusted to the same setting. Uneven settings can cause poor handling and loss of stability.

The spring preload can be adjusted by turning the adjusting nuts.

Adjust the spring preload as follows.

1. Loosen the locknut.
2. To increase the spring preload and thereby harden the suspension, turn the adjusting nut in direction (a). To decrease the spring preload and thereby soften the suspension, turn the adjusting nut in direction (b).

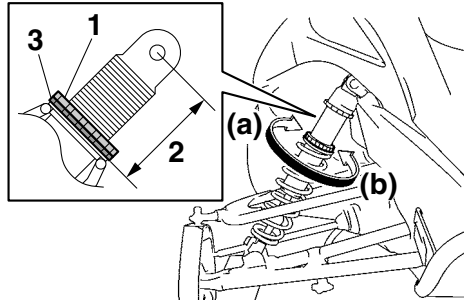

1. Locknut
2. Distance A
3. Spring preload adjusting nut

TIP

The spring preload setting is determined by measuring distance A, shown in the illustration. The longer distance A is, the higher the spring preload; the shorter distance A is, the lower the spring preload.

Spring preload setting*:

Minimum (soft):
144.3 mm (5.68 in)

Standard:
161.3 mm (6.35 in)

Maximum (hard):
171.3 mm (6.74 in)

* Distance A changes 1.5 mm (0.06 in) with each full turn of the adjusting nut.

3. Tighten the locknut to the specified torque. **NOTICE: Always tighten the locknut against the adjusting nut, and then tighten the locknut to the specified torque.** [EC500860]

Tightening torque:

Locknut:
42 Nm (4.2 m·kgf, 30 ft·lbf)

ESU13711

Adjusting the air pressure of the front shock absorbers (FX10RTRS/FX10M53S/FX10M62S)

EWS00730

WARNING

The air pressure of the left and right shock absorbers must be adjusted to the same setting. Uneven settings can cause poor handling and loss of stability.

FX10RTRS

The air pressure of the shock absorbers can be adjusted using the shock absorber pump included with your snowmobile.

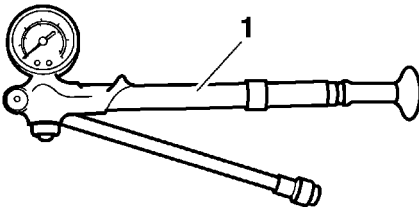

1. Shock absorber pump

To adjust the air pressure

EWS00621

WARNING

Support the snowmobile securely on a suitable stand before adjusting the shock absorbers. Otherwise, the snowmobile could fall and cause injury.

ECS00710

NOTICE

Make sure that there is no load on the shock absorbers and that they are fully extended before making any air pressure adjustments.

1. Place the snowmobile on a level surface and apply the parking brake.

2. Lift the front of the snowmobile onto a suitable stand to raise the skis off the ground.
3. Remove the air valve cap from the shock absorber.

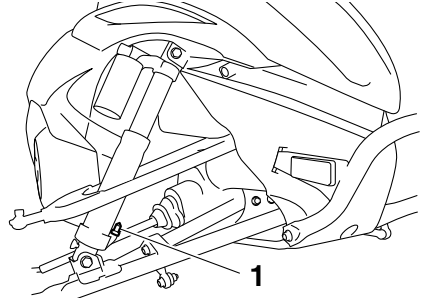

1. Air valve cap
4. Install the hose connector of the shock absorber pump onto the air valve of the shock absorber and tighten it approximately six turns until the pressure registers on the pump gauge. **NOTICE: Do not overtighten the connector onto the air valve as this will damage the connector seal.** [ECS00721]

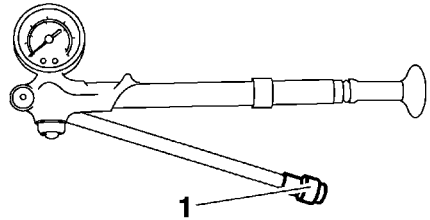

1. Hose connector

TIP

If the shock absorber has no air pressure, the gauge reading will be zero.

5. To increase the air pressure, operate the pump a few times. The pressure should increase slowly. If the pressure increases

Control functions

rapidly, check to make sure that the pump is properly connected and tightened onto the air valve. To decrease the air pressure, push the black bleed valve button. **NOTICE: Do not exceed 1034 kPa (10.3 kgf/cm², 150 psi).** [ECS00733]

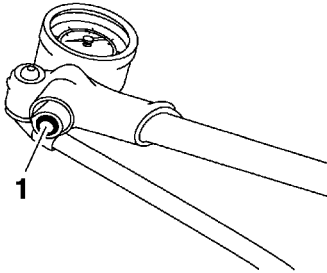
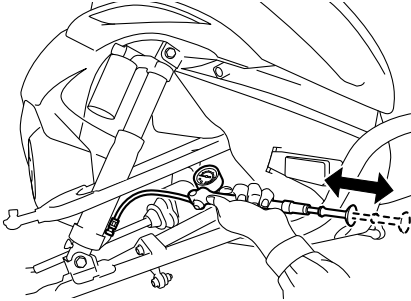

1. Bleed valve button

Air pressure range:
FX10RTRS 345–1034 kPa (3.5–10.3 kgf/cm², 50–150 psi)
Recommended air pressure:
FX10RTRS 621 kPa (6.2 kgf/cm², 90 psi)

TIP

To allow pressure to escape from the pump and the shock absorber, push the button half-way down and hold it. To allow only a small amount of pressure to escape, push the button all the way down and quickly release it.

6. Remove the hose connector from the air valve.

TIP

When removing the connector, the sound of air escaping may be heard, but this is from the pump hose, not the shock absorber.

7. Install the air valve cap.

TIP

If the front shock absorber bottoms too easily or rolls too much during cornering, increase the air pressure by 34 kPa (0.3 kgf/cm², 5 psi). If the shock absorber is too firm and you want a more compliant ride, decrease the air pressure by 34 kPa (0.3 kgf/cm², 5 psi).

FX10M53S/FX10M62S

A shock absorber pump is provided with your snowmobile to adjust the air pressure of the shock absorbers. This pump is equipped with an air pressure gauge. One side of the gauge has a low-pressure meter and the other side of the gauge has a high-pressure meter. Use the low-pressure meter to adjust the front shock absorbers.

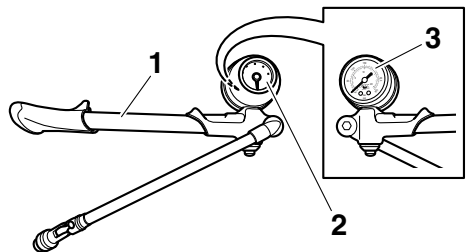

1. Shock absorber pump
2. Pressure gauge (low-pressure meter)
3. Pressure gauge (high-pressure meter)

Control functions

To adjust the air pressure

EWS00621



WARNING

Support the snowmobile securely on a suitable stand before adjusting the shock absorbers. Otherwise, the snowmobile could fall and cause injury.

ECS00710

NOTICE

Make sure that there is no load on the shock absorbers and that they are fully extended before making any air pressure adjustments.

1. Place the snowmobile on a level surface and apply the parking brake.
2. Lift the front of the snowmobile onto a suitable stand to raise the skis off the ground.
3. Remove the air valve cap from the shock absorber.

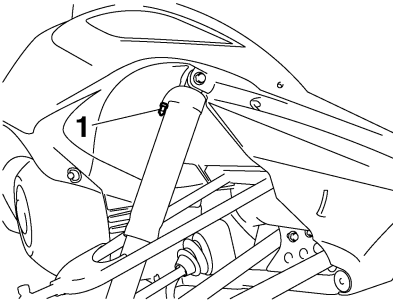

1. Air valve cap

4. Install the hose connector of the shock absorber pump onto the air valve of the shock absorber, tighten it approximately six turns until the pressure registers on the pump gauge, and then pull the hose connector lock lever up. **NOTICE: Do not overtighten the connector onto the air valve as this will damage the connector seal.** [ECS00721]

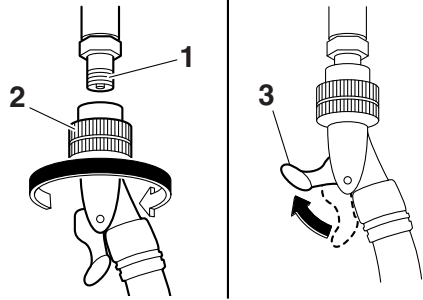

1. Air valve
2. Hose connector
3. Hose connector lock lever

TIP

If the shock absorber has no air pressure, the gauge reading will be zero.

5. To increase the air pressure, operate the pump a few times. The pressure should increase slowly. If the pressure increases rapidly, check to make sure that the pump is properly connected and tightened onto the air valve. To decrease the air pressure, push the black bleed valve button. **NOTICE: Do not exceed 1034 kPa (10.3 kgf/cm², 150 psi).** [ECS00733]

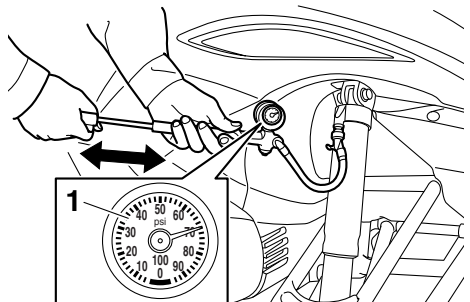

1. Pressure gauge (low-pressure meter)

Control functions

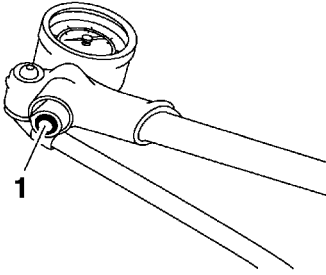

1. Bleed valve button

Air pressure range:

FX10M53S 345–1034 kPa (3.5–10.3 kgf/cm², 50–150 psi)

FX10M62S 345–1034 kPa (3.5–10.3 kgf/cm², 50–150 psi)

Recommended air pressure:

FX10M53S 483 kPa (4.8 kgf/cm², 70 psi)

FX10M62S 483 kPa (4.8 kgf/cm², 70 psi)

TIP

To allow pressure to escape from the pump and the shock absorber, push the button half-way down and hold it. To allow only a small amount of pressure to escape, push the button all the way down and quickly release it.

6. Push the hose connector lock lever down, and then remove the hose connector from the air valve.

TIP

When removing the connector, the sound of air escaping may be heard, but this is from the pump hose, not the shock absorber.

7. Install the air valve cap.

TIP

If the front shock absorber bottoms too easily or rolls too much during cornering, increase the air pressure by 34 kPa (0.3 kgf/cm², 5 psi).

If the shock absorber is too firm and you want a more compliant ride, decrease the air pressure by 34 kPa (0.3 kgf/cm², 5 psi).

ESU10926

Adjusting the damping forces of the front shock absorbers (FX10RTRS)

EWS00740

WARNING

The damping forces of the left and right shock absorbers must be adjusted to the same settings. Uneven settings can cause poor handling and loss of stability.

Compression damping force

The compression damping force of each shock absorber can be adjusted by turning its compression damping force adjusting knob.

To increase the compression damping force, turn the adjusting knob in direction (a). To decrease the compression damping force, turn the adjusting knob in direction (b).

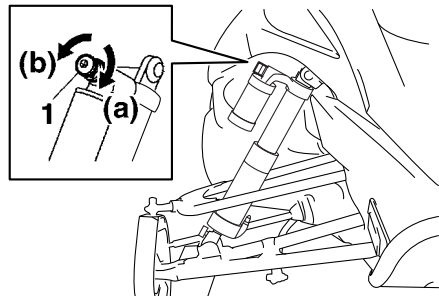

1. Compression damping force adjusting knob

Compression damping setting:

Minimum (soft):

19 click(s) in direction (b)*

Standard:

10 click(s) in direction (b)*

Maximum (hard):

1 click(s) in direction (b)*

* With the adjusting knob fully turned in direction (a)

Rebound damping force

The rebound damping force of each shock absorber can be adjusted by turning its rebound damping force adjusting knob.

To increase the rebound damping force, turn the adjusting knob in direction (a). To decrease the rebound damping force, turn the adjusting knob in direction (b).

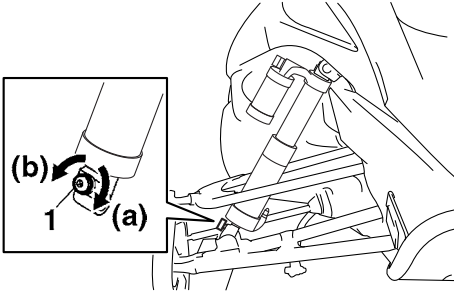

1. Rebound damping force adjusting knob

Rebound damping setting:

Minimum (soft):

19 click(s) in direction (b)*

Standard:

10 click(s) in direction (b)*

Maximum (hard):

1 click(s) in direction (b)*

* With the adjusting knob fully turned in direction (a)

TIP

The damping forces will not decrease past the minimum levels even if the adjusting knobs are turned out more than the minimum settings.

ESU13134

Adjusting the spring preload of the center shock absorber and the rear torsion springs

(FX10/FX10RTRS/FX10XT/FX10XT75)

The spring preload can be adjusted by turning the adjusting nut on the center shock absorber and the adjusters on the rear torsion springs. Adjust the spring preload as follows.

Center shock absorber

1. Loosen the locknut.
2. To increase the spring preload and thereby harden the suspension, turn the adjusting nut in direction (a). To decrease the spring preload and thereby soften the suspension, turn the adjusting nut in direction (b).

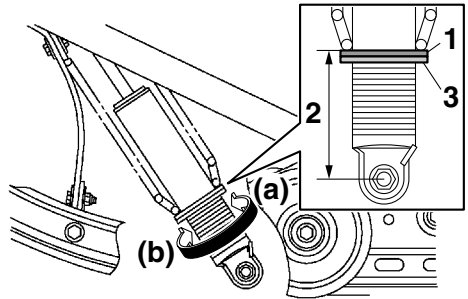

1. Spring preload adjusting nut

2. Distance A

3. Locknut

TIP

The spring preload setting is determined by measuring distance A, shown in the illustration. The longer distance A is, the higher the spring preload; the shorter distance A is, the lower the spring preload.

Control functions

Spring preload setting*:

Minimum (soft):

FX10 93.6 mm (3.69 in)
FX10RTRS 75.4 mm (2.97 in)
FX10XT/FX10XT75 106.1 mm
(4.18 in)

Standard:

FX10 101.6 mm (4.00 in)
FX10RTRS 84.4 mm (3.32 in)
FX10XT/FX10XT75 122.1 mm
(4.81 in)

Maximum (hard):

FX10 109.6 mm (4.31 in)
FX10RTRS 91.4 mm (3.60 in)
FX10XT/FX10XT75 132.1 mm
(5.20 in)

* Distance A changes 1.5 mm (0.06 in) with each full turn of the adjusting nut.

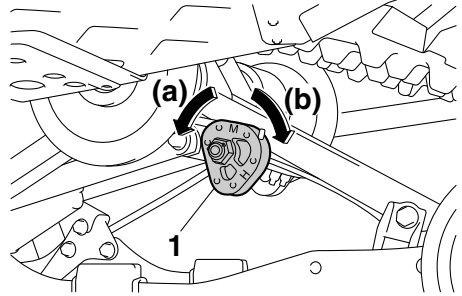

1. Spring preload adjuster

Spring preload setting:

Minimum (soft):

S

Standard:

M

Maximum (hard):

H

3. Tighten the locknut to the specified torque. **NOTICE: Always tighten the locknut against the adjusting nut, and then tighten the locknut to the specified torque.** [ECS00860]

Tightening torque:

Locknut:

42 Nm (4.2 m·kgf, 30 ft·lbf)

Rear torsion springs

EWS00750



WARNING

The left and right spring preloads must be adjusted to the same setting. Uneven settings can cause poor handling and loss of stability.

To increase the spring preload and thereby harden the suspension, turn the adjuster in direction (a). To decrease the spring preload and thereby soften the suspension, turn the adjuster in direction (b).

ESU13631

Adjusting the air pressure of the center shock absorber and the rear shock absorber (FX10M53S/FX10M62S)

A shock absorber pump is provided with your snowmobile to adjust the air pressure of the shock absorbers. This pump is equipped with an air pressure gauge. One side of the gauge has a low-pressure meter and the other side of the gauge has a high-pressure meter. Use the low-pressure meter to adjust the center shock absorber and the high-pressure meter to adjust the rear shock absorber.

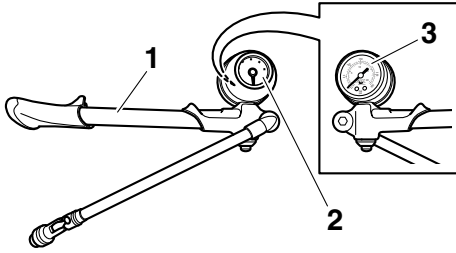

1. Shock absorber pump
2. Pressure gauge (low-pressure meter)
3. Pressure gauge (high-pressure meter)

EWS00621

WARNING

Support the snowmobile securely on a suitable stand before adjusting the shock absorbers. Otherwise, the snowmobile could fall and cause injury.

ECS00710

NOTICE

Make sure that there is no load on the shock absorbers and that they are fully extended before making any air pressure adjustments.

Center shock absorber

To adjust the air pressure

1. Place the snowmobile on a level surface and apply the parking brake.
2. Lift the rear of the snowmobile onto a suitable stand to raise the drive track off the ground.
3. Remove the air valve cap from the shock absorber.

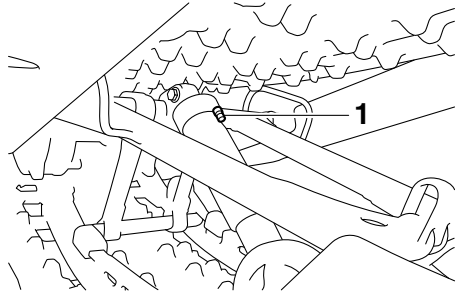

1. Air valve cap
4. Install the hose connector of the shock absorber pump onto the air valve of the shock absorber, tighten it approximately six turns until the pressure registers on the pump gauge, and then pull the hose connector lock lever up. **NOTICE: Do not overtighten the connector onto the air valve as this will damage the connector seal.** [ECS00721]

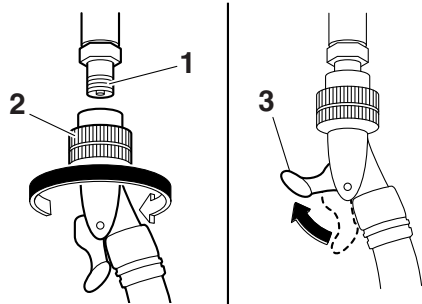

1. Air valve
2. Hose connector
3. Hose connector lock lever

TIP

If the shock absorber has no air pressure, the gauge reading will be zero.

5. To increase the air pressure, operate the pump a few times. The pressure should increase slowly. If the pressure increases rapidly, check to make sure that the pump is properly connected and tight-

Control functions

ened onto the air valve. To decrease the air pressure, push the black bleed valve button. **NOTICE: Do not exceed 1406 kPa (14.1 kgf/cm², 200 psi).** [ECS00981]

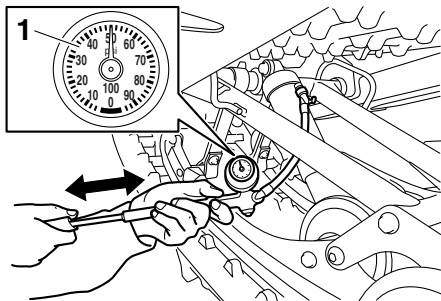

1. Pressure gauge (low-pressure meter)

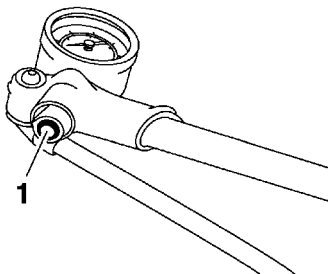

1. Bleed valve button

Air pressure range:

FX10M53S 246–1406 kPa (2.5–14.1 kgf/cm², 35–200 psi)

FX10M62S 246–1406 kPa (2.5–14.1 kgf/cm², 35–200 psi)

Recommended air pressure:

FX10M53S 345 kPa (3.5 kgf/cm², 50 psi)

FX10M62S 345 kPa (3.5 kgf/cm², 50 psi)

TIP

To allow pressure to escape from the pump and the shock absorber, push the button half-way down and hold it. To allow only a small amount of pressure to escape, push the button all the way down and quickly release it.

6. Push the hose connector lock lever down, and then remove the hose connector from the air valve.

TIP

When removing the connector, the sound of air escaping may be heard, but this is from the pump hose, not the shock absorber.

7. Install the air valve cap.

TIP

If the shock absorber bottoms too easily or rolls too much during cornering, increase the air pressure by 34 kPa (0.3 kgf/cm², 5 psi). If the shock absorber is too firm and you want a more compliant ride, decrease the air pressure by 34 kPa (0.3 kgf/cm², 5 psi).

Rear shock absorber

To adjust the air pressure

1. Place the snowmobile on a level surface and apply the parking brake.
2. Lift the rear of the snowmobile onto a suitable stand to raise the drive track off the ground.
3. Remove the air valve cap from the shock absorber.

Control functions

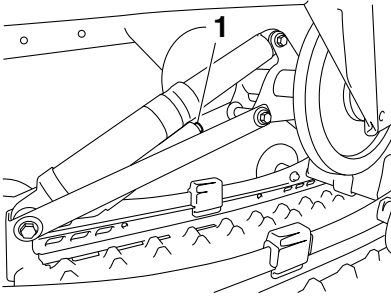

1. Air valve cap

4. Install the hose connector of the shock absorber pump onto the air valve of the shock absorber, tighten it approximately six turns until the pressure registers on the pump gauge, and then pull the hose connector lock lever up. **NOTICE: Do not overtighten the connector onto the air valve as this will damage the connector seal.** [ECS00721]

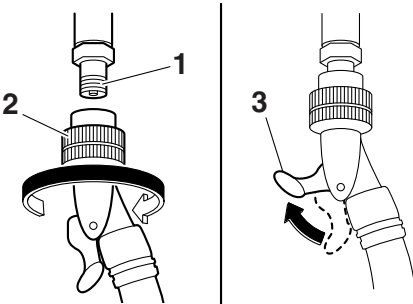

1. Air valve
2. Hose connector
3. Hose connector lock lever

TIP

If the shock absorber has no air pressure, the gauge reading will be zero.

5. To increase the air pressure, operate the pump a few times. The pressure should increase slowly. If the pressure increases rapidly, check to make sure that the pump is properly connected and tight-

ened onto the air valve. To decrease the air pressure, push the black bleed valve button. **NOTICE: Do not exceed 1406 kPa (14.1 kgf/cm², 200 psi).** [ECS00981]

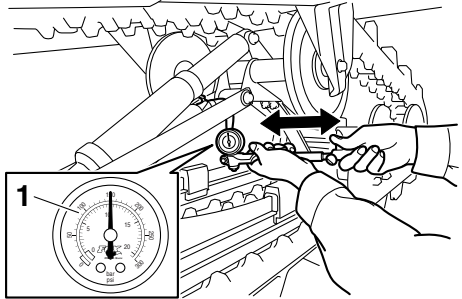

1. Pressure gauge (high-pressure meter)

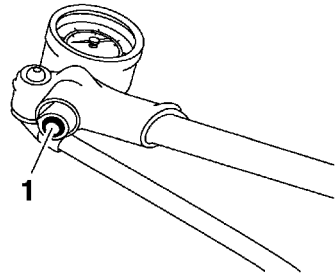

1. Bleed valve button

Air pressure range:

FX10M53S 773–1406 kPa (7.7–14.1 kgf/cm², 110–200 psi)

FX10M62S 773–1406 kPa (7.7–14.1 kgf/cm², 110–200 psi)

Recommended air pressure:

FX10M53S 1034 kPa (10.3 kgf/cm², 150 psi)

FX10M62S 1034 kPa (10.3 kgf/cm², 150 psi)

Control functions

TIP

To allow pressure to escape from the pump and the shock absorber, push the button half-way down and hold it. To allow only a small amount of pressure to escape, push the button all the way down and quickly release it.

6. Push the hose connector lock lever down, and then remove the hose connector from the air valve.

TIP

When removing the connector, the sound of air escaping may be heard, but this is from the pump hose, not the shock absorber.

7. Install the air valve cap.

TIP

If the shock absorber bottoms too easily or rolls too much during cornering, increase the air pressure by 34 kPa (0.3 kgf/cm², 5 psi). If the shock absorber is too firm and you want a more compliant ride, decrease the air pressure by 34 kPa (0.3 kgf/cm², 5 psi).

ESU13721

Adjusting the damping forces of the center and rear shock absorbers (FX10RTRS), or damping force of the rear shock absorber (FX10XT/FX10XT75)

ECS00881

NOTICE

- Do not continue to turn the adjuster in direction (a) after it stops. The shock absorber could be damaged and damping force adjustments will not be able to be made.
- Do not turn the adjuster in direction (b) beyond the adjustable range. Even if the adjuster is continually turned beyond the adjustable range, there will be no change in the damping force.

FX10RTRS

The compression and rebound damping forces can be adjusted by turning the adjusting bolt, dial, knob, or screw.

Center shock absorber

To increase the compression damping force, turn the adjusting screw in direction (a). To decrease the compression damping force, turn the adjusting screw in direction (b).

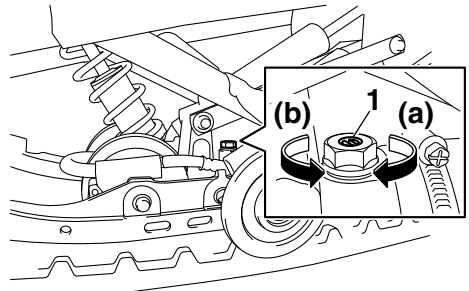

1. Compression damping force adjusting screw

Compression damping force setting:

Minimum (soft):

12 click(s) in direction (b)*

Standard:

6 click(s) in direction (b)*

Maximum (hard):

2 click(s) in direction (b)*

* With the adjusting screw fully turned in direction (a)

To increase the rebound damping force, turn the adjusting dial in direction (a). To decrease the rebound damping force, turn the adjusting dial in direction (b).

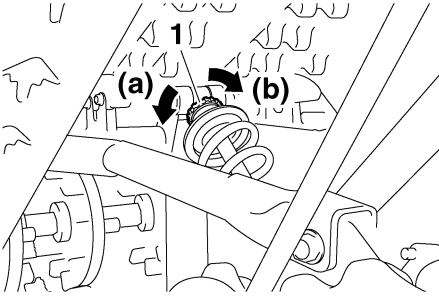

1. Rebound damping force adjusting dial

Rebound damping force setting:

Minimum (soft):

20 click(s) in direction (b)*

Standard:

11 click(s) in direction (b)*

Maximum (hard):

3 click(s) in direction (b)*

* With the adjusting dial fully turned in direction (a)

Rear shock absorber

To increase the compression damping force (for fast compression damping), turn the adjusting bolt in direction (a). To decrease the compression damping force, turn the adjusting bolt in direction (b).

To increase the compression damping force (for slow compression damping), turn the adjusting screw in direction (a). To decrease the compression damping force, turn the adjusting screw in direction (b).

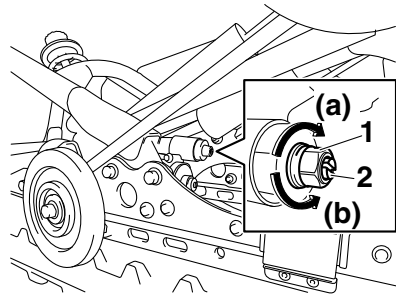

1. Compression damping force adjusting bolt (for fast compression damping)
2. Compression damping force adjusting screw (for slow compression damping)

Compression damping force setting (for fast compression damping):

Minimum (soft):

4 turn(s) in direction (b)*

Standard:

2 turn(s) in direction (b)*

Maximum (hard):

0 turn(s) in direction (b)*

* With the adjusting bolt fully turned in direction (a)

Compression damping force setting (for slow compression damping):

Minimum (soft):

16 click(s) in direction (b)*

Standard:

6 click(s) in direction (b)*

Maximum (hard):

1 click(s) in direction (b)*

* With the adjusting screw fully turned in direction (a)

To increase the rebound damping force, turn the adjusting dial in direction (a). To decrease the rebound damping force, turn the adjusting dial in direction (b).

Control functions

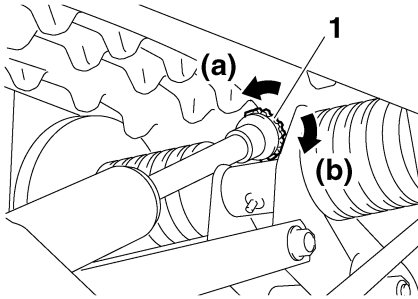

1. Rebound damping force adjusting dial

Rebound damping force setting:

Minimum (soft):

20 click(s) in direction (b)*

Standard:

11 click(s) in direction (b)*

Maximum (hard):

3 click(s) in direction (b)*

* With the adjusting dial fully turned in direction (a)

FX10XT/FX10XT75

The compression damping force can be adjusted by turning the adjusting knob.

To increase the compression damping force, turn the adjusting knob in direction (a). To decrease the compression damping force, turn the adjusting knob in direction (b).

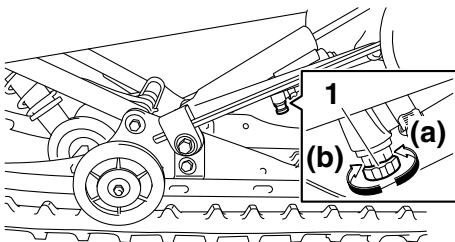

1. Compression damping force adjusting knob

Compression damping force setting:

Minimum (soft):

12 click(s) in direction (b)*

Standard:

6 click(s) in direction (b)*

Maximum (hard):

2 click(s) in direction (b)*

* With the adjusting knob fully turned in direction (a)

ESU11034

Adjusting the control rods (FX10XT/FX10XT75)

EWS00770



WARNING

The left and right adjusting nuts must be set to the same position. Uneven settings can cause poor handling and loss of stability.

The weight transfer can be adjusted by turning the adjusting nuts on the control rods.

1. Loosen the locknut while holding the adjusting nut.

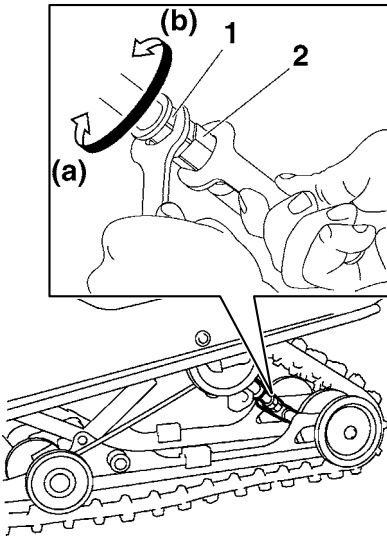

1. Locknut
2. Control rod adjusting nut
2. To increase weight transfer, turn the adjusting nut in direction (a), and to decrease weight transfer, turn it in direction (b). **WARNING! Never adjust the control rods beyond the maximum setting, indicated by red paint; otherwise, they could be damaged, which could lead to an accident or injury.** [EWS00173]

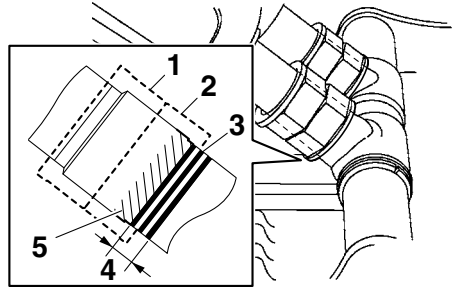

1. Locknut
2. Control rod adjusting nut
3. Standard position
4. Adjustable range
5. Red paint area
3. Tighten the locknut while holding the adjusting nut in place. **NOTICE: Always tighten the locknut against the adjusting nut, and then tighten the locknut to the specified torque.** [ECS00860]

Locknut tightening torque:
25 Nm (2.5 m·kgf, 18 ft·lbf)

Pre-operation checks

ESU11071

Inspect your vehicle each time you use it to make sure the vehicle is in safe operating condition. Always follow the inspection and maintenance procedures and schedules described in the Owner's Manual.

EWS00191



Failure to inspect or maintain the vehicle properly increases the possibility of an accident or equipment damage. Do not operate the vehicle if you find any problem. If a problem cannot be corrected by the procedures provided in this manual, have the vehicle inspected by a Yamaha dealer.

ESU11081

Pre-operation check list

ITEM	CHECKS	PAGE
Fuel	<ul style="list-style-type: none">• Check fuel level.• Refuel if necessary.• Check fuel line for leakage.	32
Engine oil	<ul style="list-style-type: none">• Check oil level in engine.• If necessary, add recommended oil to specified level.• Check vehicle for oil leakage.	69
Coolant	<ul style="list-style-type: none">• Check coolant level.• Add if necessary.	74
V-belt	<ul style="list-style-type: none">• Check for wear and damage.• Replace if necessary.	76
Drive guard	<ul style="list-style-type: none">• Make sure the drive guard is installed securely.• Check the drive guard mounts for damage.	30
Brake	<ul style="list-style-type: none">• Check operation.• If soft or spongy, have Yamaha dealer bleed hydraulic system.• Check brake pads for wear.• Replace if necessary.• Check fluid level in master cylinder.• If necessary, add recommended brake fluid to specified level.• Check hydraulic system for leakage.	79
Air filter	<ul style="list-style-type: none">• Check that there is no snow under the air filter element.• If necessary, brush off the snow.	67
Tool kit and recommended equipment	<ul style="list-style-type: none">• Check for proper placement.	63, 63
Shroud and covers	<ul style="list-style-type: none">• Make sure that the shroud and covers are securely fastened.	63
Skis and ski runners	<ul style="list-style-type: none">• Check for wear and damage.• If necessary, have Yamaha dealer replace skis or ski runners.	83

Pre-operation checks

ITEM	CHECKS	PAGE
Front shock absorbers (FX10RTRS) Front, center and rear shock absorbers (FX10M53S/FX10M62S)	<ul style="list-style-type: none"> • Check air pressure. • Adjust if necessary. 	35, 40
Drive track	<ul style="list-style-type: none"> • Check the deflection. • Adjust if necessary. • Check for wear and damage. • If necessary, have a Yamaha dealer replace track. 	84
Slide runners	<ul style="list-style-type: none"> • Check for wear and damage. • If necessary, have Yamaha dealer replace slide runners. 	84
Steering	<ul style="list-style-type: none"> • Check for excessive free play. 	84
Strap (FX10M53S/FX10M62S)	<ul style="list-style-type: none"> • Check for damage. • Replace if necessary. 	56
Lights, signals and switches	<ul style="list-style-type: none"> • Check operation. • Correct if necessary. 	27, 27, 89, 89
Throttle lever	<ul style="list-style-type: none"> • Make sure that operation is smooth and spring back to its original position when released. 	21
Throttle override system (T.O.R.S.)	<ul style="list-style-type: none"> • Check the T.O.R.S. for proper operation. • If system is not functioning properly, have Yamaha dealer check vehicle. 	66

Operation

ESU13500

Read the Owner's Manual carefully to become familiar with all controls. If there is a control or function you do not understand, ask your Yamaha dealer.

EWS00201

WARNING

Failure to familiarize yourself with the controls can lead to loss of control, which could cause an accident or injury.

ESU13212

TIP

This model is equipped with:

- an engine oil pressure switch to stop the engine in case an engine oil pressure drop is detected. To start the engine after this system has stopped the engine, be sure to place the snowmobile on a level surface, and then turn the key in the main switch to the off position, and then to the on position. Failing to do so will prevent the engine from starting even though the engine will crank when turning the key to the start position. If the engine does not start or if it stops again, ask a Yamaha dealer to inspect the snowmobile.
- an engine overheating prevention system, which prevents overheating when the engine is idling. When the engine has been idling for 3 minutes or longer and the coolant temperature has risen above 100 °C (212 °F), the engine automatically stops to prevent overheating. The engine can be started after it stops.

ESU11303

Starting the engine

1. Apply the parking brake.

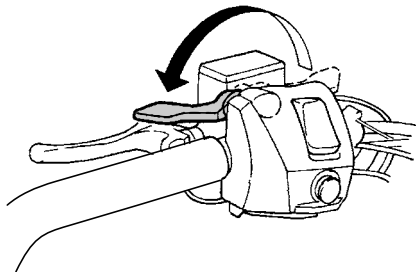

2. Be sure the engine stop switch is in the run position. The starter motor cannot be operated when the engine stop switch is in the off position.

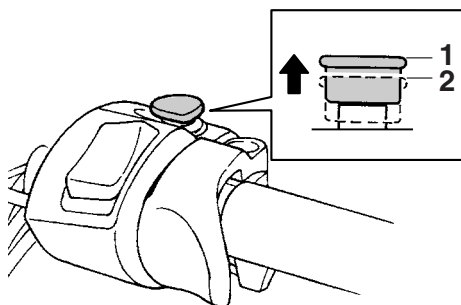

1. Run position
 2. Off position
3. Turn the main switch to the start position and release it when the engine starts.
NOTICE: Release the switch immediately after the engine starts. If the engine fails to start, release the switch, wait a few seconds, then try again. Each attempt should be as short as possible to preserve the battery. Do not crank the engine more than 10 seconds on any one attempt. [ECS00331]

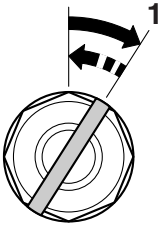

1. Start
4. Warm up the engine until it runs smoothly.
5. Be sure the low coolant temperature indicator light has gone out before operation. (See page 23 for detailed information about the indicator light.)

ESU11310

Break-in

There is never a more important period in the life of your engine than the period between 0 and 500 km (300 mi). For this reason, you should read the following material carefully. Since the engine is brand new, do not put an excessive load on it for the first 500 km (300 mi). The various parts in the engine wear and polish themselves to the correct operating clearances. During this period, prolonged full-throttle operation or any condition that might result in engine overheating must be avoided.

Operating your snowmobile for the first time

Start the engine and let it idle for 15 minutes.

0–160 km (0–100 mi)

Avoid prolonged operation above 6000 r/min.

160–500 km (100–300 mi)

Avoid prolonged operation above 8000 r/min.

500 km (300 mi) and beyond

The snowmobile can now be operated normally.

ECS00340

NOTICE

- After 800 km (500 mi) of operation, the engine oil must be changed and the oil filter cartridge replaced.
- If any engine trouble should occur during the engine break-in period, immediately have a Yamaha dealer check the snowmobile.

ESU12624

Riding your snowmobile

Getting to know your snowmobile

EWS00211

WARNING

To avoid severe injury or death:

- Keep both hands on the handlebar during operation.
- Never put your feet outside the running boards.
- Avoid higher speeds or more difficult maneuvers until you have become thoroughly familiar with your snowmobile and all of its controls.

A snowmobile is a rider active vehicle, and your riding position and your balance are the two basic factors of maneuvering your snowmobile.

Riding your snowmobile requires skills acquired through practice over a period of time. Take the time to learn the basic techniques well before attempting more difficult maneuvers.

Riding your new snowmobile can be a very enjoyable activity, providing you with hours of pleasure. However, it is essential to familiarize yourself with the operation of the snowmobile to achieve the skill necessary to enjoy riding safely. Before operating the snowmobile, read this Owner's Manual completely and understand the operation of the controls.

Operation

Pay particular attention to the safety information on page 16.

Please read all warning and notice labels on your snowmobile.

Also, read the Snowmobiler's Safety Handbook that is supplied with your snowmobile (for Canada).

Learning to ride your snowmobile

Before you ride, always perform the pre-operation checks listed on page 48. The short time spent checking the condition of the snowmobile will be rewarded with added safety and a more reliable snowmobile. Always wear the proper clothing for both warmth and to help protect you from injury if an accident occurs.

Become familiar with operating your snowmobile at low speeds, even if you are an experienced rider. Do not attempt to operate at maximum performance until you are totally familiar with the snowmobile's handling and performance characteristics.

The beginning operator should select a large flat area to become familiar with the snowmobile. Make sure that this area is free of obstacles and other traffic. You should practice control of the throttle and brake, and master turning techniques in this area before trying more difficult terrain.

Set the parking brake and follow the instructions on page 50 to start the engine. Once the engine has warmed up, you are ready to begin riding your snowmobile.

To start out and accelerate

1. With the engine idling, release the parking brake.
2. Apply the throttle slowly and smoothly. The V-belt clutch will engage and you will start to accelerate. **WARNING! Do not allow anyone to stand behind the snowmobile when starting the engine.**

A broken track, track fittings, or debris thrown by the track could be dangerous to bystanders. [EWS00690]

Braking

EWS00220

WARNING

- Many surfaces such as ice and hard-packed snow require much longer stopping distances. Be alert, plan ahead, and begin decelerating early.
- Improper use of the brake can cause the drive track to lose traction, reduce control, and increase the possibility of an accident.

When slowing down or stopping, release the throttle and apply the brake gently—not suddenly.

Turning

For most snow surfaces, “body English” is the key to turning.

As you approach a curve, slow down and begin to turn the handlebar in the desired direction. As you do so, put your weight on the running board to the inside of the turn and lean your upper body into the turn.

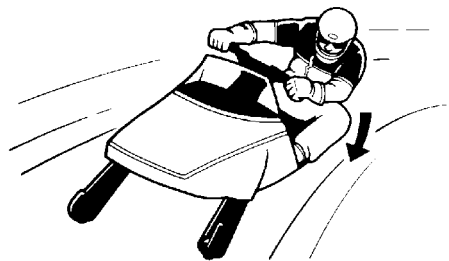

This procedure should be practiced at low speeds many times, in a large flat area with no obstacles. Once you have learned this technique, you should be able to perform it at high-

er speeds or in tighter curves. Lean more as the turn gets sharper or is made at higher speeds.

Improper riding techniques such as abrupt throttle changes, excessive braking, incorrect body movements, or too much speed for the sharpness of the turn may cause the snowmobile to tip.

If your snowmobile begins to tip while turning, lean more into the turn to regain balance. If necessary, gradually let off on the throttle or steer to the outside of the turn.

Remember:

Avoid higher speeds until you are thoroughly familiar with the operation of your snowmobile.

Riding uphill

EWS00231



Operation on slopes can lead to loss of control if proper techniques are not used. Follow these instructions to reduce your risk of an accident. Do not try steeper or more difficult inclines until you have developed your skill on gentle slopes.

You should practice first on gentle slopes. Try more difficult climbs only after you have developed your skill. As you approach a hill, accelerate before you start the climb, and then reduce the throttle to prevent track slippage. It is also important to keep your weight on the uphill side at all times. On climbs straight up the hill, this can be accomplished by leaning forward and, on steeper inclines, standing on the running boards and leaning forward over the handlebar. (Also see "Traversing a slope".)

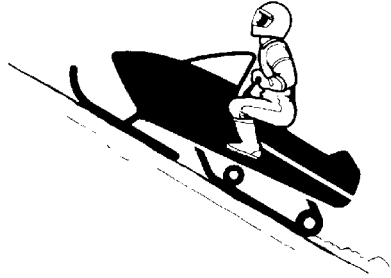

Slow down as you reach the crest of the hill, and be prepared to react to obstacles, sharp drops, or other vehicles or people which may be on the other side. If you are unable to continue up a hill, do not spin the track. Stop the engine and set the parking brake. Then pull the rear of the snowmobile around to point the snowmobile back down the hill. When the snowmobile is pointed downhill, mount your snowmobile from the uphill side. Restart the engine, release the parking brake, and descend the hill.

Riding downhill

EWS00240



Use extra caution when applying the brake during a descent. Excessive braking will cause the drive track to lock, causing a loss of control.

When riding downhill, keep speed to a minimum. It is important to apply just enough throttle to keep the clutch engaged while descending the hill. This will allow you to use engine compression to help slow the snowmobile, and to keep the snowmobile from rolling freely down the hill. Also apply the brake frequently, with light pressure.

Operation

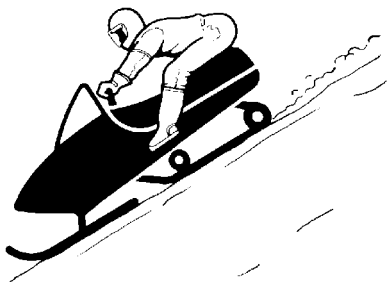

Traversing a slope

EWS00251

! WARNING

Driving across the face of a slope (“side-hilling”) can lead to overturn or loss of control if proper techniques are not used. Follow these instructions to reduce your risk of an accident. Do not try steeper or more difficult inclines until you have developed your skill on gentle slopes.

Traversing a slope requires you to properly position your weight to maintain proper balance. As you travel across the slope, lean your body to position your weight towards the uphill side. A recommended riding position is to kneel with the knee of your downhill leg on the seat and the foot of your uphill leg on the running board. This position will make it easier for you to shift your body weight as needed.

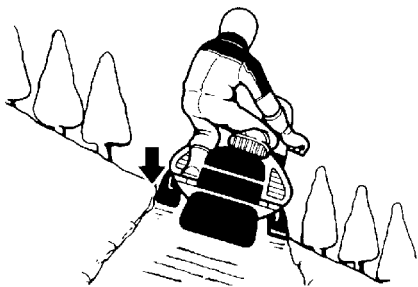

Snow and ice are slippery, so be prepared for the possibility that your snowmobile could begin to slip sideways on the slope. If this happens, steer in the direction of the slide if there are no obstacles in your path. As you regain proper balance, gradually steer again in the direction you wish to travel.

If your snowmobile starts to tip, steer down the hill to regain balance. **WARNING! If you are unable to maintain correct balance, and your snowmobile is going to tip over, dismount your snowmobile immediately on the uphill side to avoid being hit or caught under the snowmobile as it tips over.** [EWS00261]

Ice or icy surface

EWS00270

! WARNING

When you have to operate on ice or icy surfaces, drive slowly and cautiously. Avoid accelerating, turning, and braking rapidly. Steering is minimal and uncontrolled spins are an ever-present danger.

Operating on ice or icy surfaces can be very dangerous. Traction for turning, stopping, and starting is much less than that on snow.

Hard-packed snow

It can be more difficult to negotiate on hard-packed snow as both the skis and drive track do not have as much traction as when the snowmobile is operated on fresh snow. Avoid rapid acceleration, turning, and braking.

Operation on surfaces other than snow or ice

Operation of your snowmobile on surfaces other than snow or ice should be avoided. Operation under such conditions will damage or result in rapid wear of the ski runners, drive

track, slide runners, and drive sprockets. Operation of the snowmobile on the following surfaces should be avoided at all times:

- Dirt
- Sand
- Rocks
- Grass
- Bare pavement

Other surfaces that should be avoided for the sake of drive track and slide runner life are:

- Glare ice surfaces
- Snow mixed with a lot of dirt and sand

All of the above surfaces have one thing in common in regard to drive track and slide runners: little or no lubricating ability. Drive track and all slide rail systems require lubrication (snow or water) between the slide runners and the slide metal. In the absence of lubrication, the slide runners will rapidly wear and in severe cases, literally melt away, and the drive track will be subject to damage or failure. Also traction aids such as studs, cleats, etc., may cause further track damage or failure.

EWS00280

WARNING

Drive track damage or failure could result in loss of braking ability and snowmobile control, which could cause an accident.

- **Always check the drive track for damage or maladjustment before operating the snowmobile.**
- **Do not operate the snowmobile if you find damage to the drive track.**

ECS00350

NOTICE

Ride on fresh snow frequently. Operating on ice or hard-packed snow will rapidly wear the slide runners.

ESU11350

Maximizing drive track life

Recommendations

Track tension

During initial break-in, the new drive track will tend to stretch quickly as the track settles. Be sure to correct the track tension and alignment frequently. (See page 84 for adjustment procedures.) A loose track can slip (ratchet), derail or catch on suspension parts causing severe damage. Do not overtighten the drive track, otherwise it may increase the friction between the track and the slide runners, resulting in the rapid wear of both components. Also, this may put an excessive load on the suspension components, resulting in component failure.

Marginal snow

The drive track and the slide runners are lubricated and cooled by snow and water. To prevent the drive track and slide runners from overheating, avoid sustained high-speed usage in areas such as icy trails, frozen lakes and rivers that have minimal snow coverage. An overheated track will be weakened internally, which may cause failure or damage.

Off-trail riding

Avoid off-trail riding until there is sufficient snow coverage. It generally takes several feet of snow to provide a good overall base to properly cover debris, such as rocks, logs, etc. If snow coverage is not sufficient, stay on trails to avoid impact damage to the drive track.

Studded track

In general, track life will be shortened when studs are installed. Drilling stud holes into the drive track will cut the internal fibers, which weakens the track. Avoid spinning the drive track. Studs may catch on an object and pull out of the track, leaving tears and damage

Operation

around the already weakened area. To minimize possible damage, consult your stud manufacturer for installation and stud pattern recommendations.

Yamaha does not recommend track strapping.

ESU11360

Strap (FX10M53S/FX10M62S)

The strap should be used only by experienced operators to assist them when traverse (side-hill) riding.

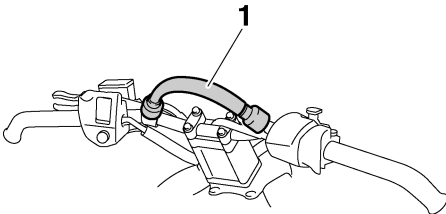

1. Strap

EWS00290

WARNING

Improper use of the strap on the handlebar can result in severe injury or death.

- Use the strap only as an operator grip point when needed to shift weight uphill to maintain balance during traverse (side-hill) riding. Only experienced operators should traverse slopes steep enough to require strap use.
- Keep the right hand on the right handlebar grip for steering, and grip the strap with the left hand to shift weight uphill for balance during traverse riding.
- Ride cautiously while using the strap. Do not accelerate or decelerate abruptly while holding onto the strap.
- Do not use the strap to lift the snowmobile.

- Do not use the strap as a mounting point for cargo or accessories.

ESU13224

Driving

EWS00300

WARNING

Be sure to read the “SAFETY INFORMATION” section on page 16 and the “Riding your snowmobile” section on page 51 carefully before operating the snowmobile.

EWS00310

WARNING

- Make sure that the throttle lever is fully released and the snowmobile is at a full stop before shifting.
- Be sure to slide the shift lever to “FWD” or “REV” until it stops completely and only while the engine is idling.
- Make sure that the area behind the snowmobile is clear before reversing. Watch behind.
- Reduce speed and avoid sharp turning when operating the snowmobile in reverse.

TIP

Make sure that the engine is warmed up enough before riding.

1. To select the desired operating position, pull the shift lever out, slide it to “FWD” or to “REV” until it stops, and then push it back in. **NOTICE:** Do not shift from “FWD” to “REV” or from “REV” to “FWD” while the snowmobile is moving, as the drive train could be damaged. [ECS00811]

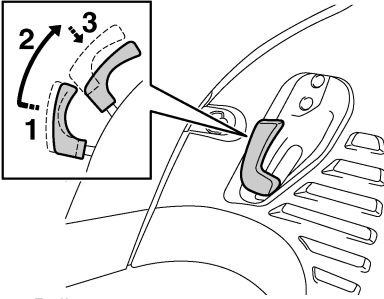

1. Pull out.
2. Slide to "FWD" (forward).
3. Push in.

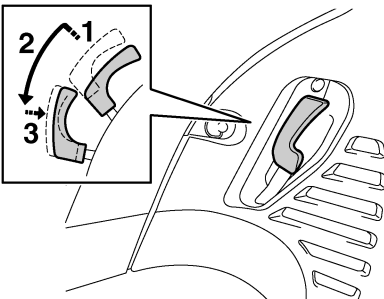

1. Pull out.
2. Slide to "REV" (reverse).
3. Push in.

TIP

The reverse buzzer beeps while the shift lever is in reverse.

2. While squeezing the brake lever, release the parking brake by moving the parking brake lever to the right, and then release the brake lever.

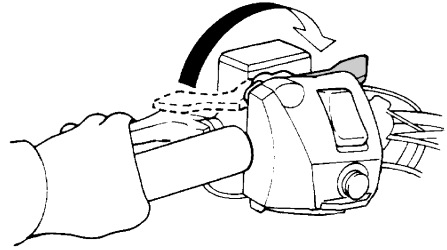

3. Squeeze the throttle lever slowly to start out.
4. Turn the handlebar in the desired direction.
5. Squeeze the brake lever to stop the snowmobile.
6. Apply the parking brake by moving the parking brake lever to the left.

ESU11411

Stopping the engine

- Turn the main switch to the off position to stop the engine.

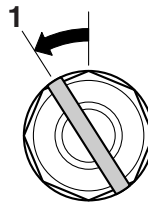

1. Off
- Push down the engine stop switch to stop the engine in an emergency.

Operation

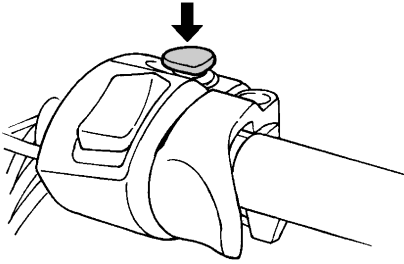

ESU11430

Transporting

When transporting your snowmobile on a trailer or in a truck, observe the following recommendations to help protect it from damage:

- If transporting the snowmobile in an open trailer or truck, put a tight fitting cover on the snowmobile. A cover specifically designed for your snowmobile is best. This will help keep foreign objects out of the cooling vents, and also help protect the snowmobile against damage from debris on the road.
- If transporting the snowmobile in an open trailer or truck in areas where road salt is used, coat metal suspension surfaces lightly with oil or another protectant. This will help protect against corrosion. Be sure to clean the snowmobile when you get to your destination to remove any corrosive salts.

Periodic maintenance and adjustment

ESU13181

Periodic inspection, adjustment, and lubrication will keep your snowmobile in the safest and most efficient condition possible. Safety is an obligation of the vehicle owner/operator. The most important points of vehicle inspection, adjustment, and lubrication are explained on the following pages.

EWS00341



Failure to properly maintain the snowmobile or performing maintenance activities incorrectly may increase your risk of injury or death during service or while using the snowmobile. If you are not familiar with snowmobile service, have a Yamaha dealer perform service.

EWS00700



Turn off the engine when performing maintenance unless otherwise specified.

- **A running engine has moving parts that can catch on body parts or clothing, and electrical parts that can cause shocks or fires.**
 - **Running the engine while servicing can lead to eye injury, burns, fire, or carbon monoxide poisoning—possibly leading to death. See page 16 for more information about carbon monoxide.**
-

EWS00790



Brake discs, calipers, and linings can become very hot during use. To avoid possible burns, let brake components cool before touching them.

Periodic maintenance and adjustment

ESU11461

Periodic maintenance chart for the emission control system

Items marked with an asterisk should be performed by a Yamaha dealer as they require special tools, data and technical skills.

	ITEM	REMARKS	INITIAL	EVERY	PAGE
			1 month or 800 km (500 mi) (40 hr)	Seasonally or 4000 km (2500 mi) (200 hr)	
	Spark plugs	<ul style="list-style-type: none"> • Check condition. • Adjust gap and clean. • Replace if necessary. 		●	65
*	Valve clearance	<ul style="list-style-type: none"> • Check and adjust valve clearance when engine is cold. 	Every 40000 km (25000 mi)		68
*	Crankcase breather system	<ul style="list-style-type: none"> • Check breather hose for cracks or damage. • Replace if necessary. 		●	—
*	Fuel line	<ul style="list-style-type: none"> • Check fuel hose for cracks or damage. • Replace if necessary. 		●	—
*	Fuel injection	<ul style="list-style-type: none"> • Check synchronization. • Adjust if necessary. 	●	●	—
*	Exhaust system	<ul style="list-style-type: none"> • Check for leakage. • Tighten or replace gasket if necessary. 		●	—

Periodic maintenance and adjustment

ESU11565

General maintenance and lubrication chart

ITEM	REMARKS	INITIAL	EVERY	PAGE
		1 month or 800 km (500 mi) (40 hr)	Seasonally or 4000 km (2500 mi) (200 hr)	
Engine oil	<ul style="list-style-type: none"> Change (warm engine before draining). 	●	●	69
* Engine oil filter cartridge	<ul style="list-style-type: none"> Replace. 	●	Every 20000 km (12000 mi)	69
* Cooling system	<ul style="list-style-type: none"> Check coolant level. Bleed the cooling system if necessary. 		●	74
* Primary and secondary clutches	<ul style="list-style-type: none"> Check engagement and shift speed. Adjust if necessary. 		●	—
		Whenever operating elevation is changed.		—
	<ul style="list-style-type: none"> Inspect sheaves for wear and damage. Inspect weights/rollers and bushings for wear for primary. Inspect ramp shoes/bushings for wear for secondary. Replace if necessary. 		●	—
	<ul style="list-style-type: none"> Lubricate with specified grease. 		●	—
* Drive chain	<ul style="list-style-type: none"> Check chain slack. Adjust if necessary. 	Initial at 500 km (300 mi) and every 800 km (500 mi) thereafter.		78
* Drive chain oil	<ul style="list-style-type: none"> Check oil level. 	●	●	78
	<ul style="list-style-type: none"> Change. 		●	78
* Shift lever	<ul style="list-style-type: none"> Lubricate with specified grease. 		●	—
* Brake and parking brake	<ul style="list-style-type: none"> Adjust free play and/or replace pads if necessary. 		●	79
	<ul style="list-style-type: none"> Change brake fluid. 	See TIP following this chart.		79
Control cables	<ul style="list-style-type: none"> Make sure that operation is smooth. Lubricate if necessary. 		●	88
* Disc brake installation	<ul style="list-style-type: none"> Check for slight free play. Lubricate shaft with specified grease as required. 	Every 1600 km (1000 mi)		—

Periodic maintenance and adjustment

	ITEM	REMARKS	INITIAL	EVERY	PAGE
			1 month or 800 km (500 mi) (40 hr)	Seasonally or 4000 km (2500 mi) (200 hr)	
*	Extrovert drive sprocket (FX10/FX10RTRS/ FX10XT75/ FX10M53S/ FX10M62S)	<ul style="list-style-type: none"> • Check for wear and damage. • Replace if necessary. 	●	●	82
*	Slide runners	<ul style="list-style-type: none"> • Check for wear and damage. • Replace if necessary. 		●	84
*	Skis and ski runners	<ul style="list-style-type: none"> • Check for wear and damage. • Replace if necessary. 		●	83
*	Steering system	<ul style="list-style-type: none"> • Check toe-out. • Adjust if necessary. 		●	84
*	Steering bearings	<ul style="list-style-type: none"> • Check bearing assemblies for looseness. • Lubricate with specified grease. 		●	—
*	Suspension component	<ul style="list-style-type: none"> • Lubricate with specified grease. • Check ball joints for wear and damage. • Replace if necessary. 		●	88
*	Drive track	<ul style="list-style-type: none"> • Check the deflection. • Adjust if necessary. 	Initial at 500 km (300 mi) and every 800 km (500 mi) thereafter.		84
	Fittings and fasteners	<ul style="list-style-type: none"> • Make sure that all nuts, bolts and screws are properly tightened. • Tighten if necessary. 	●	●	90
*	Battery	<ul style="list-style-type: none"> • Check condition. • Charge if necessary. 		●	90

TIP

Brake system:

- After disassembling the master cylinder or caliper cylinder, always change the brake fluid. Regularly check the brake fluid level and add fluid if necessary.
- Replace the oil seals of the master cylinder and caliper cylinder every two years.
- Replace the brake hose every four years, or if cracked or damaged.

Periodic maintenance and adjustment

ESU13003

Tool kit

The owner's tool kit is located in the storage pouch. (See page 31 for more information about the storage pouch.)

The service information included in this manual and the tools provided in the owner's tool kit are intended to assist you in the performance of preventive maintenance and minor repairs. However, additional tools such as a torque wrench may be necessary to perform certain maintenance work correctly.

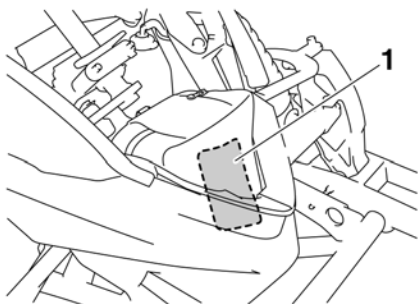

1. Tool kit

ECS00781

NOTICE

Before starting the engine, make sure that the tool kit is securely fastened and that the storage pouch zipper is completely closed.

TIP

If you do not have a torque wrench available during a service operation requiring one, take your snowmobile to a Yamaha dealer to check the torque settings and adjust them if necessary.

ESU14230

Recommended equipment

It is good practice to carry the spare parts and other necessary equipment with you while riding the snowmobile so that minor repairs can be done if necessary. The following should be carried at all times:

- Flashlight
- Roll of plastic tape
- Steel wire
- Tow rope
- V-belt
- Light bulbs

When you start out for a long distance trip, extra fuel should be carried as well.

ESU12783

Removing and installing the shroud and covers

EWS00091

⚠ WARNING

Be sure shroud and covers are secured before operation. A loose shroud or cover could move and cause loss of control.

Shroud

To remove the shroud

Loosen the fasteners, and then slide the shroud forward.

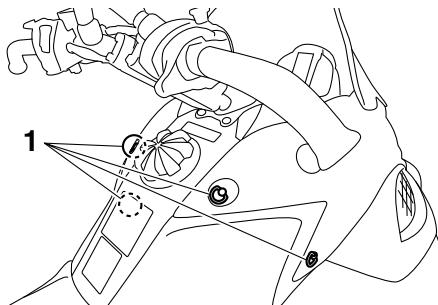

1. Fastener

Periodic maintenance and adjustment

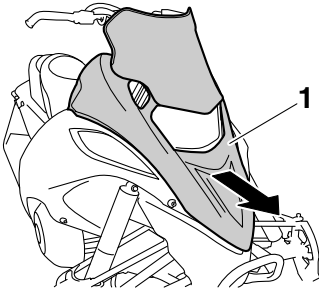

1. Shroud

To install the shroud

Hook the end of the shroud onto the front cover, insert the projections on the shroud into the slots in the headlight unit stay, and then tighten the fasteners.

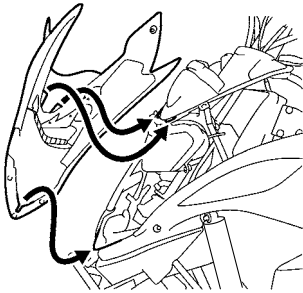

Left and right side covers

To remove a side cover

1. Remove the shroud. (See above for removal procedures.)
2. Loosen the fasteners, and then remove the side cover as shown.

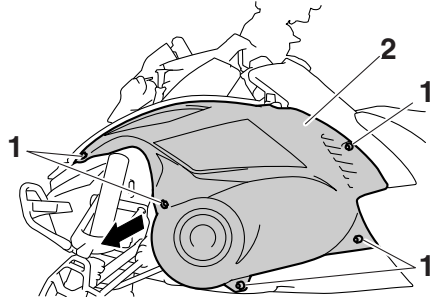

1. Fastener
2. Left side cover

To install a side cover

1. Insert the projection on the rear of the side cover into the slot in the fuel tank side cover and insert the projections on the front of the side cover into the slots in the lower cover.

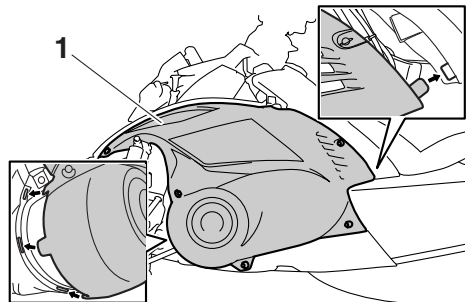

1. Left side cover
2. Tighten the fasteners.
3. Install the shroud.

ECS00372

NOTICE

- Make sure that all cables, hoses and leads are routed properly before installing the shroud and covers.
- When installing the shroud and covers, be sure to tighten the fasteners securely.

Periodic maintenance and adjustment

ESU11784

Checking the spark plugs

The spark plugs are important engine components and are easy to inspect. The condition of the spark plugs can indicate the condition of the engine.

Check the coloration on the white porcelain insulator around the center electrode. The ideal coloration at this point is a medium-to-light tan color for a snowmobile that is being ridden normally. If any spark plug shows a distinctly different color, there could be something wrong with the engine. For example, a very white center electrode porcelain color could indicate an intake track air leak or carburetion problem for that cylinder. Do not attempt to diagnose such problems yourself. Instead, take the snowmobile to a Yamaha dealer for inspection and possible repairs.

You should periodically remove and inspect the spark plugs because heat and deposits will cause any spark plug to slowly break down and erode. Consult a Yamaha dealer before changing to a different type of spark plug.

Specified spark plug:
Manufacturer:
NGK
Model:
CR9E

EWS00710



WARNING

Be sure to use the specified spark plug and spark plug cap. Otherwise, the T.O.R.S. may not work properly.

Spark plugs are produced in several different thread lengths. The thread length or reach is the distance from the spark plug gasket seat to the end of the threaded portion. If the reach is too long, overheating and engine damage may result. If the reach is too short, spark plug

fouling and poor performance may result. Also, if the reach is too short, carbon will form on the exposed threads resulting in combustion chamber hot spots and thread damage. Always use a spark plug with the specified reach.

Spark plug reach:
19.0 mm (0.75 in)

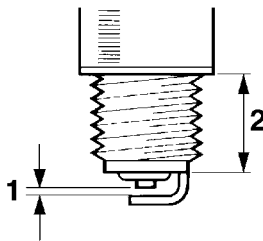

1. Spark plug gap
2. Spark plug reach

Before installing any spark plug, measure the spark plug gap with a wire thickness gauge and adjust to specification.

Spark plug gap:
0.7–0.8 mm (0.028–0.031 in)

When installing the spark plug, always clean the gasket surface. Wipe off any grime from the threads and tighten the spark plug to the specified torque.

Spark plug tightening torque:
13 Nm (1.3 m·kgf, 9.4 ft·lbf)

ECS00382

NOTICE

Make sure that the spark plug caps are securely installed. Otherwise the spark plug caps could be damaged due to engine vibration.

Periodic maintenance and adjustment

ESU13663

Adjusting the throttle lever free play

1. Slide the rubber cover back.
2. Loosen the locknut.
3. To increase the throttle lever free play, turn the adjusting nut in direction (a). To decrease the throttle lever free play, turn the adjusting nut in direction (b).

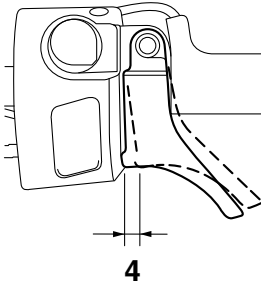
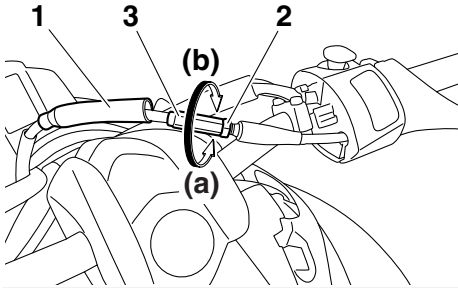

1. Rubber cover
2. Locknut
3. Throttle lever free play adjusting nut
4. Throttle lever free play

Throttle lever free play:
3.0–4.0 mm (0.12–0.16 in)

4. Tighten the locknut.
5. Slide the rubber cover to its original position.

ESU11863

Checking the throttle override system (T.O.R.S.)

EWS00352



When checking the T.O.R.S., take precautions to avoid snowmobile movement which could cause an accident:

- Make sure that the throttle lever moves smoothly with the engine off before checking the T.O.R.S.
- Make sure that the parking brake is applied.
- Do not rev the engine to the point that the clutch engages.

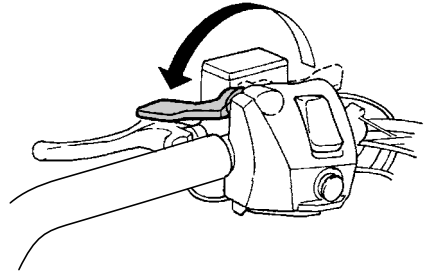

Check the T.O.R.S. for proper operation.

1. Start the engine.

TIP

Refer to the “Starting the engine” section on page 50.

2. Hold the pivot point of the throttle lever away from the throttle switch by putting your thumb (above) and forefinger (below) between the throttle lever pivot and the engine stop switch housing. While holding the pivot point as described above, squeeze the throttle lever gradually.

Periodic maintenance and adjustment

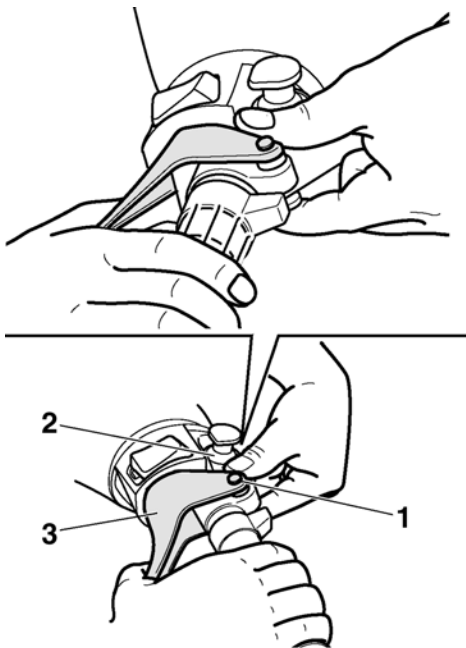

1. Throttle lever pivot
2. Engine stop switch housing
3. Throttle lever

The T.O.R.S. will be activated and the engine speed will be limited to less than the clutch engagement speed. (See page 98 for the clutch engagement speed.)

WARNING! If the engine speed does not decrease to less than the clutch engagement speed, stop the engine by turning the main switch to the off position and consult a Yamaha dealer. Operating the snowmobile with a malfunctioning T.O.R.S. could result in loss of control. [EWS00362]

ESU12803

Checking the air filter

Check that there is no snow under the air filter element frame after each ride. In addition, snow may need to be cleaned during a ride depending on the riding conditions.

1. Place the snowmobile on a level surface and apply the parking brake.
2. Remove the shroud, the left side cover, and the right side cover. (See page 63 for removal procedures.)
3. Remove the headlight unit stay quick fasteners and disconnect the air temperature sensor coupler.

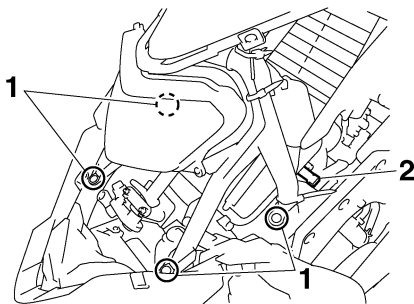

1. Quick fastener
 2. Air temperature sensor coupler
4. Unhook the air filter case cover fasteners.

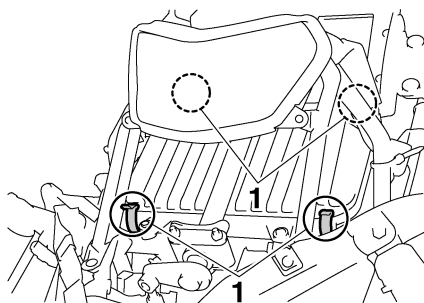

1. Air filter case cover fastener
5. Lift the headlight unit and headlight unit stay, and then slide the air filter case cover toward the right side of the snowmobile and remove it.

Periodic maintenance and adjustment

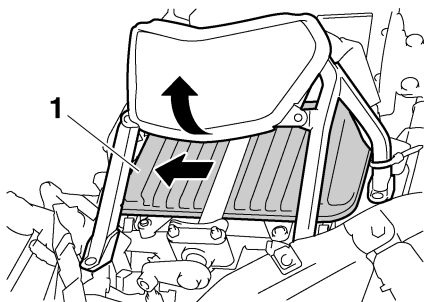

1. Air filter case cover

6. Lift up the air filter element frame and check the air filter element. If there is any snow on the air filter element, remove the element, brush off the snow, and then install the air filter element.

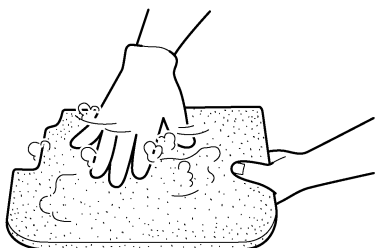
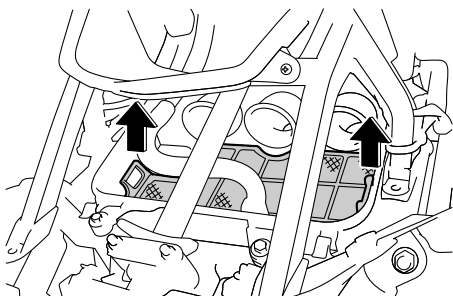

7. Place the air filter element frame in the original position, and then install the air filter case cover.
8. Hook the fasteners onto the air filter case cover.

9. Connect the air temperature sensor coupler and install the headlight unit stay quick fasteners.
10. Install the right side cover, the left side cover, and the shroud.

ESU11931

High-altitude settings

Operating at high altitude reduces the performance of a gasoline engine about 3% for every 305 m (1000 ft) of elevation. This is because there is less air as altitude increases. Less air means less oxygen available for combustion.

Your snowmobile utilizes an electronic fuel injection system that delivers the optimal air/fuel ratio required by the engine. Therefore, the fuel injection system does not need to be adjusted, even for operation at high altitude.

Remember:

Less air at higher altitude means there is less horsepower available, even with the optimal air/fuel ratio. Expect acceleration and top speed to be reduced at higher altitudes.

To overcome operating with less power at high altitudes, your snowmobile may also require different settings for the drive chain gears and V-belt clutch to avoid poor performance and rapid wear. If you plan to operate your snowmobile at an altitude different from the area where you bought it, be sure to consult a Yamaha dealer. The dealer can tell you if there are any changes necessary for the altitude where you plan to ride. **NOTICE: The drive chain gears and V-belt clutch should be adjusted when operating above a high altitude of 900 m (3000 ft). Consult a Yamaha dealer.** [ECS00431]

ESU11950

Valve clearance

The valve clearance changes with use, resulting in improper air-fuel mixture and/or engine noise. To prevent this from occurring, the

Periodic maintenance and adjustment

valve clearance must be adjusted by a Yamaha dealer at the intervals specified in the periodic maintenance chart.

ESU12817

Engine oil and oil filter cartridge

The engine oil level should be checked before each use. In addition, the oil must be changed and the oil filter cartridge replaced at the intervals specified in the periodic maintenance and lubrication chart.

EWS00370

WARNING

Engine oil is extremely hot immediately after the engine is turned off. Coming into contact with or getting any engine oil on your clothes could result in burns.

ECS00482

NOTICE

- Do not run the engine with too much or not enough oil in the oil tank. Oil could spray out or the engine could be damaged.
- Be sure to change the engine oil after the first 800 km (500 mi) of operation, and every 4000 km (2500 mi) thereafter or at the start of a new season, otherwise the engine will wear quickly.
- The oil filter cartridge should be replaced after the first 800 km (500 mi) of operation, and every 20000 km (12000 mi) of operation thereafter.

To check the engine oil level

1. Place the snowmobile on a level surface and apply the parking brake.

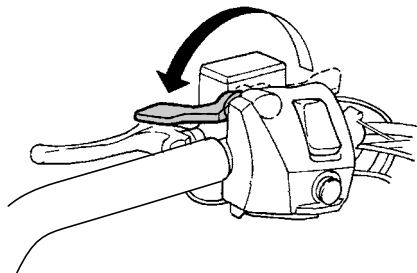

2. Start the engine, warm it up for 10–15 minutes, and then turn it off.

TIP

- The engine can also be warmed up by driving the snowmobile for 10–15 minutes.
- After operating the snowmobile, allow the engine to idle for at least 10 seconds before turning it off.

3. Remove the shroud and the right side cover. (See page 63 for removal procedures.)
4. Disconnect the oil level gauge coupler. **NOTICE: Disconnect the oil level gauge coupler before removing the oil filler cap, otherwise the cable could twist and break.** [ECS00452]

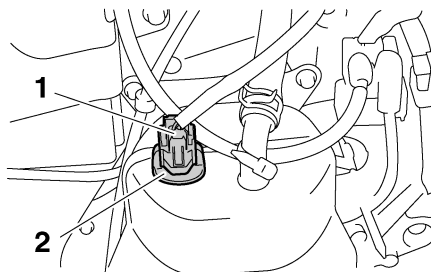

1. Oil level gauge coupler
2. Oil filler cap

Periodic maintenance and adjustment

5. Remove the oil filler cap, wipe the dipstick clean, insert it back into the oil filler hole (without screwing it in), and then remove it again to check the oil level.

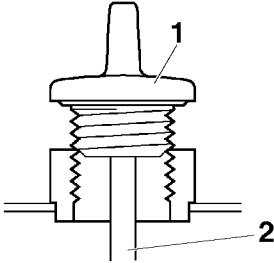

1. Oil filler cap
2. Dipstick

TIP

The engine oil should be between the “H” and “L” level marks on the dipstick.

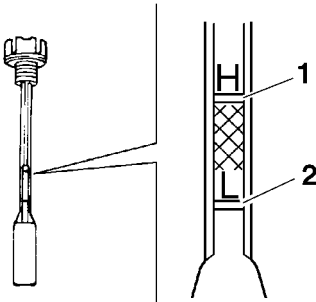

1. “H” level mark
2. “L” level mark

6. If the engine oil is below the “L” level mark, add sufficient oil of the recommended type to raise it to the “H” level mark. (See page 98 for the recommended oil.) **NOTICE: When adding the engine oil, be careful not to fill above the “H” level mark on the dipstick. Use only the recommended oil. (See page 98.) Make sure that no foreign material enters the engine oil tank.** [ECS00462]

7. Insert the dipstick into the oil filler hole, and then tighten the oil filler cap.
8. Connect the oil level gauge coupler.
9. Install the right side cover and the shroud.

To change the engine oil (with or without oil filter cartridge replacement)

1. Place the snowmobile on a level surface and apply the parking brake.
2. Start the engine, warm it up for several minutes, and then turn it off.
3. Remove the shroud, the left side cover, the right side cover, and the drive guard. (See pages 30 and 63 for removal procedures.)
4. Remove the left lower cover, the right lower cover, and the bottom panel.

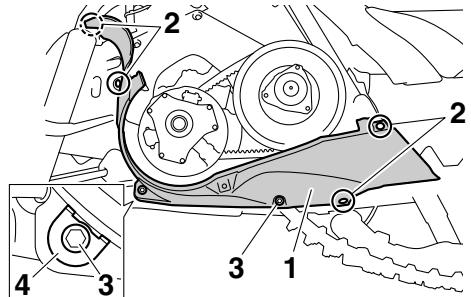

1. Left lower cover
2. Quick fastener
3. Bolt
4. Washer

Periodic maintenance and adjustment

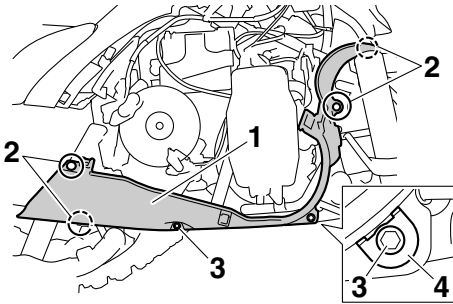

1. Right lower cover
2. Quick fastener
3. Bolt
4. Washer

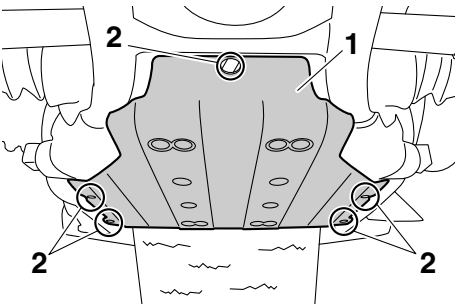

1. Bottom panel
2. Quick fastener
5. Place an oil pan under the oil tank to collect the used oil.
6. Disconnect the oil level gauge coupler.

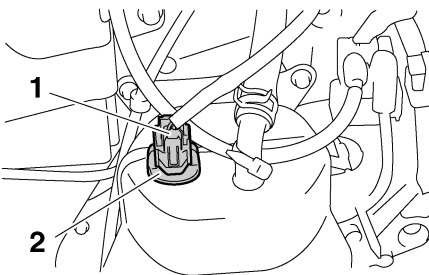

1. Oil level gauge coupler
2. Oil filler cap

7. Remove the oil filler cap and cylinder head cap, and then remove the engine oil drain bolt and its gasket to drain the oil from the oil tank.

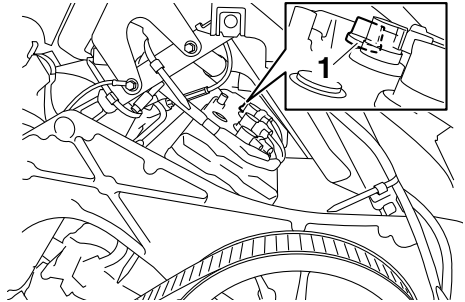

1. Cylinder head cap

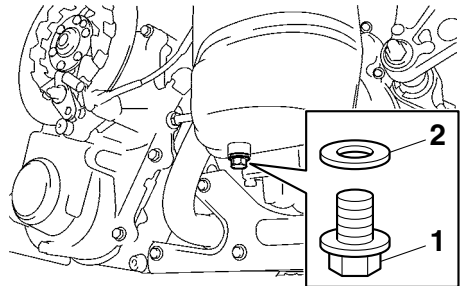

1. Engine oil drain bolt (oil tank)
2. Gasket
8. Place an oil pan under the engine to collect the used oil.
9. Remove the engine oil drain bolt and its gasket to drain the oil from the crankcase.

Periodic maintenance and adjustment

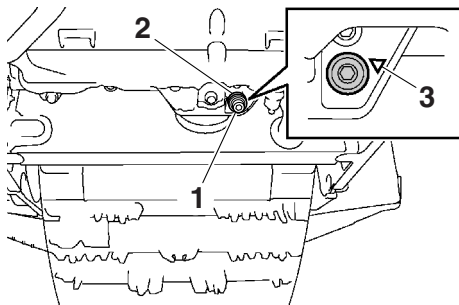

1. Engine oil drain bolt (crankcase)
2. Gasket
3. “▽” mark

TIP

- A “▽” mark is stamped on the crankcase near the engine oil drain bolt.
- Dispose of used oil according to local regulations.
- Skip steps 10–12 if the oil filter cartridge is not being replaced.

10. Remove the oil filter cartridge with an oil filter wrench.

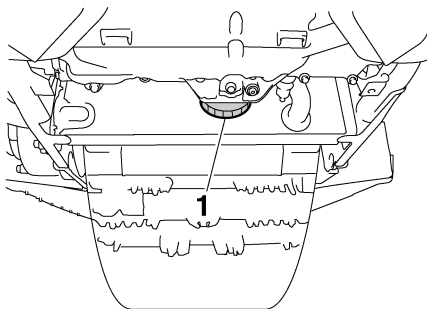

1. Oil filter cartridge

TIP

An oil filter wrench is available at a Yamaha dealer.

11. Apply a thin coat of engine oil to the O-ring of the new oil filter cartridge.

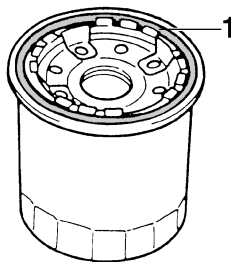

1. O-ring

TIP

Make sure that the O-ring is properly seated.

12. Install the new oil filter cartridge with an oil filter wrench, and then tighten it to the specified torque.

Tightening torque:
Oil filter cartridge:
17 Nm (1.7 m·kgf, 12 ft·lbf)

13. Install the engine oil drain bolts and their new gasket, and then tighten the bolts to the specified torques.

Tightening torques:
Engine oil drain bolt (crankcase):
10 Nm (1.0 m·kgf, 7.2 ft·lbf)
Engine oil drain bolt (oil tank):
16 Nm (1.6 m·kgf, 12 ft·lbf)

14. Add 2.0 L (2.11 US qt, 1.76 Imp.qt) of the recommended engine oil to the oil tank, and then install and tighten the oil filler cap and the cylinder head cap.
15. Start the engine, warm it up for several minutes, and then turn it off.
16. Remove the oil filler cap, and then add sufficient oil of the recommended type to raise it to the “H” level mark on the dipstick. (See above for the checking procedure.) **NOTICE: When adding the engine oil, be careful not to fill above**

Periodic maintenance and adjustment

the “H” level mark on the dipstick. Use only the recommended oil. (See page 98.) Make sure that no foreign material enters the engine oil tank. [ECS00462]

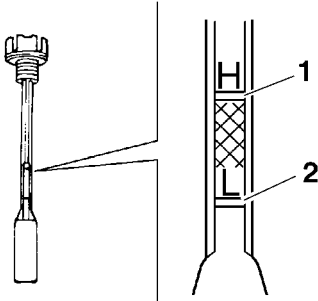

Recommended engine oil:

See page 98.

Oil quantity:

With oil filter cartridge replacement:

3.2 L (3.38 US qt, 2.82 Imp.qt)

Without oil filter cartridge replacement:

3.0 L (3.17 US qt, 2.64 Imp.qt)

Total amount:

3.9 L (4.12 US qt, 3.43 Imp.qt)

17. Install and tighten the oil filler cap.
18. Start the engine, and then let it idle for several minutes while checking it for oil leakage. If oil is leaking, immediately turn the engine off and make sure that the engine oil drain bolt, oil tank drain bolt, cylinder head cap, and the oil filler cap are installed correctly.
19. Turn the engine off, and then connect the oil level gauge coupler. **NOTICE: If oil is leaking or the oil level warning indicator comes on when the engine is running, immediately turn the engine off and have a Yamaha dealer check the snowmobile. Continuing to operate**

the engine under such conditions could cause severe engine damage.

[ECS00471]

20. Install the bottom panel.
21. Install the right lower cover and the left lower cover.

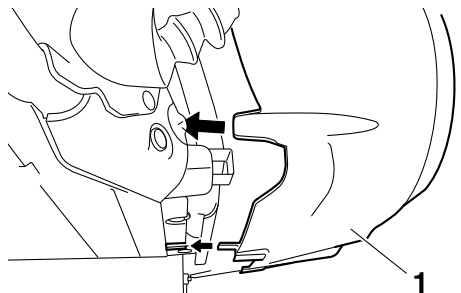
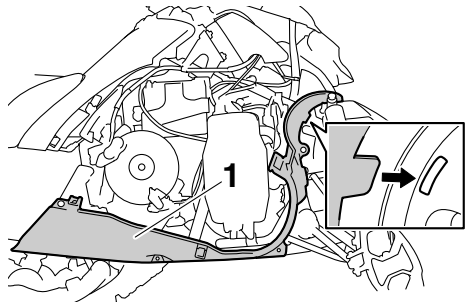
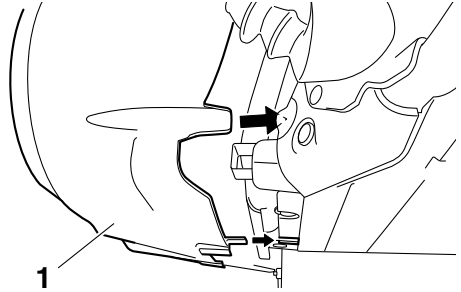

Periodic maintenance and adjustment

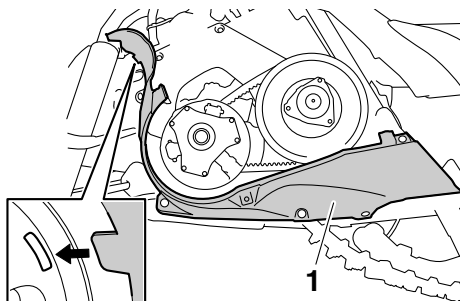

1. Left lower cover

22. Install the drive guard, the right side cover, the left side cover, and the shroud.

ESU12828

Cooling system

The coolant level should be checked before each ride. In addition, the cooling system must be bled at the intervals specified in the periodic maintenance and lubrication chart.

EWS00390

WARNING

Do not remove the radiator cap when the engine is hot. Scalding hot fluid and steam may be blown out under pressure, which could cause serious injury.

When the engine has cooled, place a thick rag or towel over the radiator cap, and slowly rotate the cap counterclockwise to the detent. This procedure allows any residual pressure to escape. When the hissing sound has stopped, press down on the cap while turning counterclockwise and remove it.

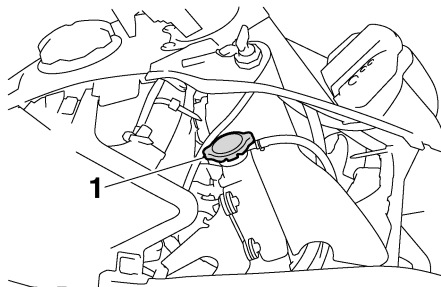

1. Radiator cap

To check the coolant level

1. Place the snowmobile on a level surface and apply the parking brake.
2. Check the coolant level in the coolant reservoir when the engine is cold. If the coolant level is below the “LOW” mark, add coolant until it reaches the “FULL” mark. (See the following section “Replenishing the coolant” for more details.)

NOTICE: If coolant is not available, use distilled water or soft tap water instead. Do not use hard water or salt water since it is harmful to the engine. If water has been used instead of coolant, replace it with coolant as soon as possible, otherwise the cooling system will not be protected against frost and corrosion. If water has been added to the coolant, have a Yamaha dealer check the antifreeze content of the coolant as soon as possible, otherwise the effectiveness of the coolant will be reduced. [ECS00492]

Periodic maintenance and adjustment

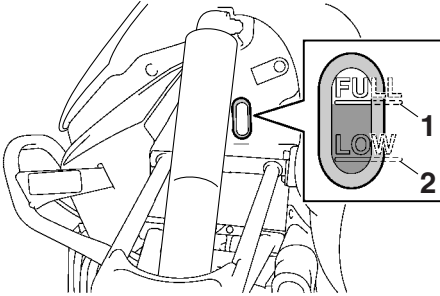

1. "FULL" mark
2. "LOW" mark

Bleeding the cooling system

The cooling system must be bled if the coolant reservoir becomes empty, if air can be seen in the cooling system, or if there is a cooling system leak. Consult a Yamaha dealer.

ECS00500

NOTICE

Operating the engine with an improperly bled cooling system can cause overheating and severe engine damage.

Replenishing the coolant

1. Place the snowmobile on a level surface and apply the parking brake.
2. Remove the shroud. (See page 63 for removal procedures.)
3. Remove the coolant reservoir cap and add coolant until it reaches the "FULL" mark.

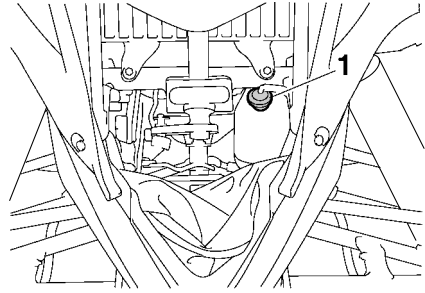

1. Coolant reservoir cap

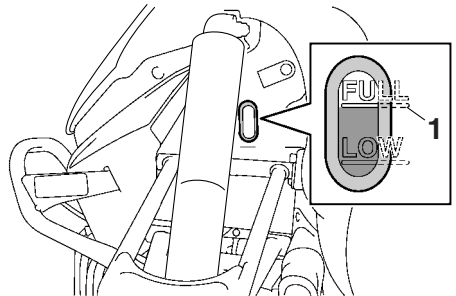
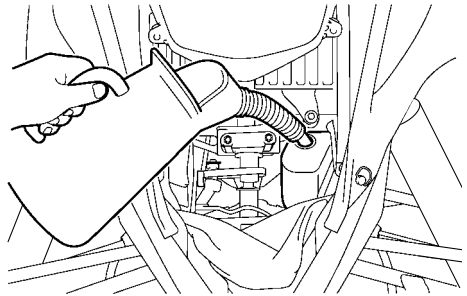

1. "FULL" mark

Periodic maintenance and adjustment

Recommended antifreeze:

High-quality ethylene glycol antifreeze containing corrosion inhibitors

Antifreeze and water mixing ratio:
3:2

Total amount:

FX10 3.80 L (4.02 US qt, 3.34 Imp.qt)

FX10M53S 4.90 L (5.18 US qt,
4.31 Imp.qt)

FX10M62S 4.90 L (5.18 US qt,
4.31 Imp.qt)

FX10RTSR 3.80 L (4.02 US qt,
3.34 Imp.qt)

FX10XT 3.80 L (4.02 US qt,
3.34 Imp.qt)

FX10XT75 4.90 L (5.18 US qt,
4.31 Imp.qt)

4. Start the engine and add coolant until the coolant level stabilizes, and then stop the engine.
5. Check for any coolant leakage. If coolant is leaking, check for the cause.

TIP

If you find any leaks, consult a Yamaha dealer.

6. Fill the coolant reservoir with coolant until it reaches the "FULL" mark.
7. Install the coolant reservoir cap.
8. Install the shroud.

ESU12067

V-belt

EWS00402

WARNING

- Coming in contact with the rotating V-belt or clutch parts can cause severe injury or death. Never run the engine with the drive guard removed.
- Make sure that the drive guard is installed securely before operating the snowmobile to protect against severe injury or death from a broken V-belt or other part should it come off the snowmobile while it is in operation.

ECS00830

NOTICE

Never run the engine with the V-belt removed. Clutch components can be damaged.

The V-belt should be checked before each ride.

To check the V-belt

1. Remove the shroud and the left side cover, and then remove the drive guard. (See pages 30 and 63 for removal procedures.)
2. Check the V-belt for wear and damage. Replace if necessary.

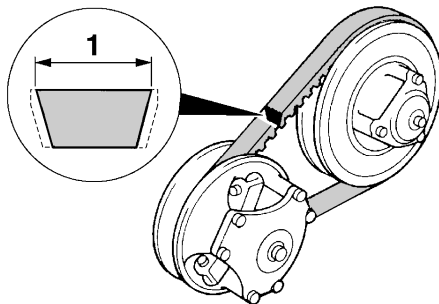

1. V-belt wear limit

New V-belt width:

34.5 mm (1.36 in)

V-belt wear limit width:

32.5 mm (1.28 in)

3. Install the drive guard, and then install the left side cover and the shroud.

To replace and adjust the V-belt

EWS00411

WARNING

When installing a new V-belt, make sure that it is positioned properly. Otherwise, the V-belt clutch engagement speed will be changed and the snowmobile may move unexpectedly when the engine is started, which could cause an accident.

Periodic maintenance and adjustment

ECS00511

NOTICE

As the V-belt wears, the position of the V-belt will change. If the V-belt position is out of specification, it must be adjusted to ensure proper clutch performance. Have a Yamaha dealer make this adjustment.

1. Place the snowmobile on a level surface and apply the parking brake.
2. Remove the shroud and the left side cover, and then remove the drive guard. (See pages 30 and 63 for removal procedures.)
3. Rotate the secondary sliding sheave clockwise and push it so that it separates from the secondary fixed sheave.

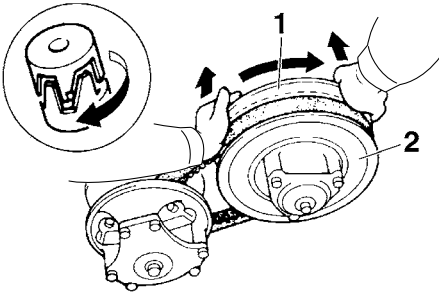

1. Secondary sliding sheave
2. Secondary fixed sheave

4. Pull the V-belt up over the secondary fixed sheave.

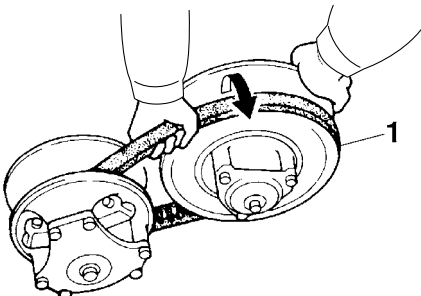

1. V-belt

5. Remove the V-belt from the secondary sheave assembly and primary sheave assembly.
6. Temporarily install the new V-belt on the secondary sheave assembly only, and then measure the V-belt position. Do not force the V-belt between the sheaves; the secondary sliding and fixed sheaves must touch each other.

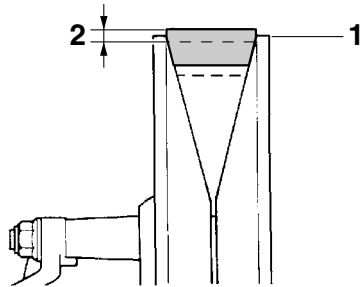
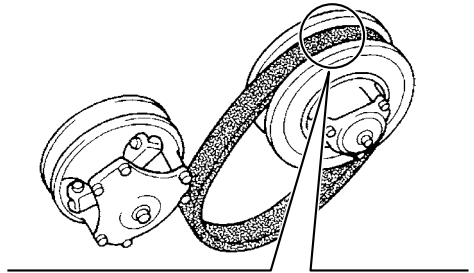

1. Edge of the secondary sheave assembly
2. Standard V-belt position

Standard V-belt position:

From 1.5 mm (0.06 in) above the edge of the secondary sheave assembly to 0.5 mm (0.02 in) below the edge

7. If the V-belt position is incorrect, adjust it by removing or adding a spacer on each V-belt position adjusting bolt.

Periodic maintenance and adjustment

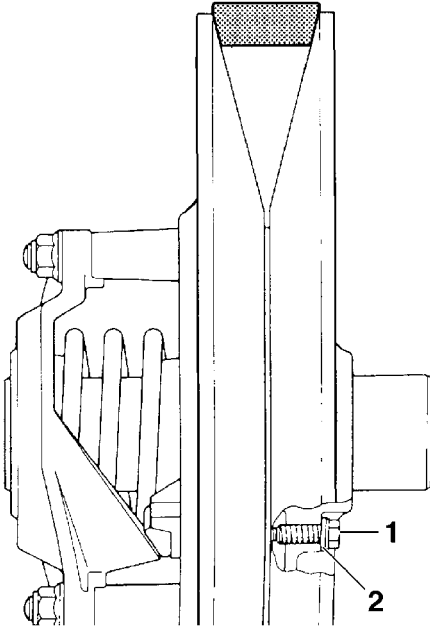

- 1. V-belt position adjusting bolt
- 2. Spacer

V-belt position	Adjustment
More than 1.5 mm (0.06 in) above the edge	Remove a spacer.
From 1.5 mm (0.06 in) above the edge to 0.5 mm (0.02 in) below the edge	Not necessary (it is correct).
More than 0.5 mm (0.02 in) below the edge	Add a spacer.

- 8. Tighten the V-belt position adjusting bolts.

V-belt position adjusting bolt tightening torque:
 10 Nm (1.0 m·kgf, 7.2 ft·lbf)

- 9. Install the V-belt over the primary sheave assembly.

- 10. Rotate the secondary sliding sheave clockwise and push it so that it separates from the secondary fixed sheave.

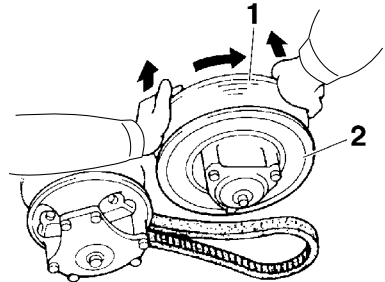

- 1. Secondary sliding sheave
- 2. Secondary fixed sheave
- 11. Install the V-belt between the secondary sliding and fixed sheaves.

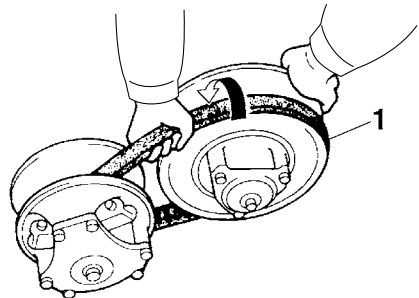

- 1. V-belt
- 12. Install the drive guard, and then install the left side cover and the shroud.

ESU12834

Drive chain housing

To check the drive chain housing oil level

- 1. Place the snowmobile on a level surface and apply the parking brake.
- 2. Remove the shroud and the right side cover. (See page 63 for removal procedures.)
- 3. Remove the dipstick, wipe it off with a clean rag, and then screw it back into the filler hole.

Periodic maintenance and adjustment

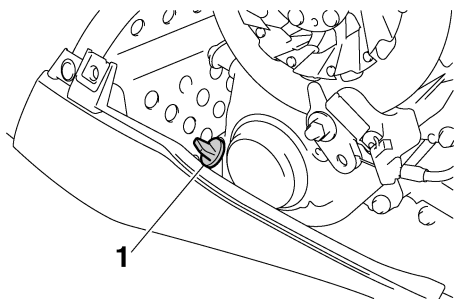

1. Dipstick
4. Remove the dipstick and check that the oil level is within the range shown at the bottom of the dipstick. If the oil does not reach the bottom of the dipstick, add sufficient oil of the recommended type to raise it to the correct level. **NOTICE:** Make sure that no foreign material enters the drive chain housing. [ECS00531]

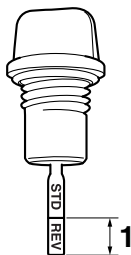

1. Oil level range

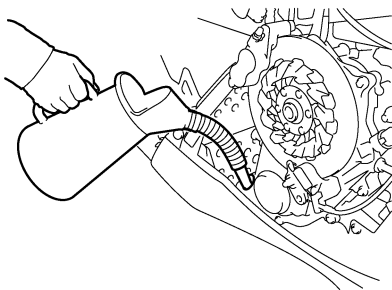

Recommended drive chain oil:
SAE 75W or 80W API GL-3 Gear oil

5. Install the dipstick.
6. Install the right side cover and the shroud.

To adjust the chain tension

1. Remove the shroud and the right side cover. (See page 63 for removal procedures.)
2. Loosen the locknut.
3. Turn the chain tension adjusting bolt clockwise until it is finger tight, and then loosen it 1/4 turn.

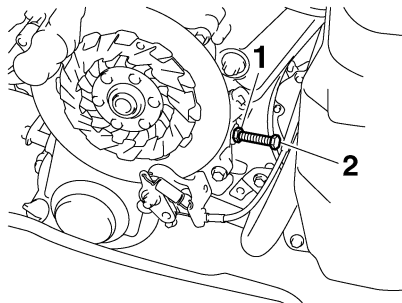

1. Locknut
2. Chain tension adjusting bolt
4. While holding the chain tension adjusting bolt with a wrench, tighten the locknut to the specified torque.

Tightening torque:

Locknut:
25 Nm (2.5 m·kgf, 18 ft·lbf)

5. Install the right side cover and the shroud.

ESU13541

Brake and parking brake

EWS00440

WARNING

- A soft, spongy feeling in the brake lever indicates a failure in the brake system.
- Do not operate the snowmobile if you find any problems in the brake system. You could lose braking ability, which could lead to an accident. Ask a Yamaha dealer to inspect and repair the brake system.

Periodic maintenance and adjustment

Test the brake at a low speed when starting out to make sure that it is working properly. If the brake does not provide proper braking performance, inspect the brake for wear or brake fluid leakage. (See the following section for more details.)

Checking the brake pads

Check the brake pads for wear according to the following procedure.

1. Place the snowmobile on a level surface and apply the parking brake.
2. Remove the shroud and the right side cover. (See page 63 for removal procedures.)
3. Check the brake pads for wear. If the brake pads reach the wear limit, ask a Yamaha dealer to replace them.

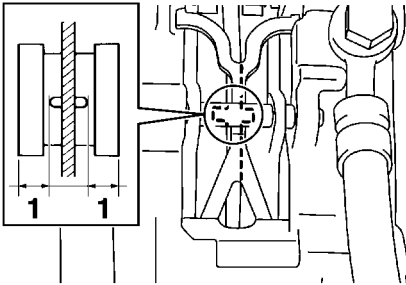

1. Brake pad wear limit

Brake pad wear limit:
4.7 mm (0.19 in)

4. Install the right side cover and the shroud.

Checking the parking brake pads

Check the parking brake pads for wear according to the following procedure.

1. Remove the shroud and the right side cover. (See page 63 for removal procedures.)

2. Check the parking brake pads for wear by measuring the thickness of the pads. If the parking brake pads reach the wear limit, ask a Yamaha dealer to replace them.

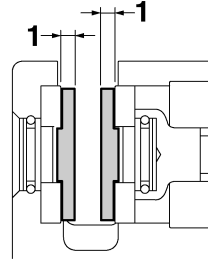

1. Parking brake pad wear limit

Parking brake pad wear limit:
1.2 mm (0.047 in)

3. Install the right side cover and the shroud.

To adjust the parking brake

As the parking brake pads wear, adjustment may be necessary to ensure proper brake performance.

1. Remove the shroud and the right side cover. (See page 63 for removal procedures.)
2. Loosen the parking brake pad adjusting bolt locknut and the parking brake pad adjusting bolt.
3. Loosen the parking brake cable locknut.
4. Turn the parking brake cable adjusting bolt in or out to adjust the cable length.

Periodic maintenance and adjustment

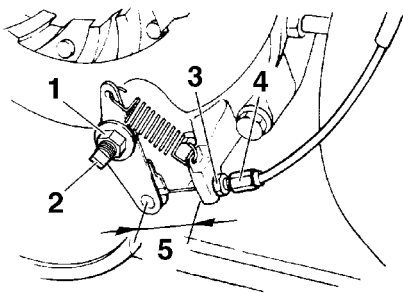

1. Parking brake pad adjusting bolt locknut
2. Parking brake pad adjusting bolt
3. Parking brake cable locknut
4. Parking brake cable adjusting bolt
5. Parking brake cable length

Parking brake cable length:
43.5–46.5 mm (1.713–1.831 in)

5. Tighten the parking brake cable locknut.
6. Turn the parking brake pad adjusting bolt in or out to adjust the clearance between the parking brake pads and the brake disc.

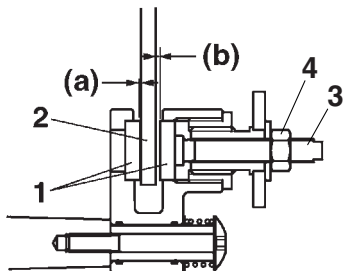

1. Parking brake pad
2. Brake disc
3. Parking brake pad adjusting bolt
4. Parking brake pad adjusting bolt locknut

Parking brake pad to brake disc clearance (a) + (b):
1.5–2.0 mm (0.059–0.079 in)

7. Tighten the parking brake pad adjusting bolt locknut.

8. Install the right side cover and the shroud.

Checking the brake fluid level

Before riding, check that the brake fluid is above the lower level. Check the brake fluid level with the top of the reservoir level. Replenish the brake fluid if necessary.

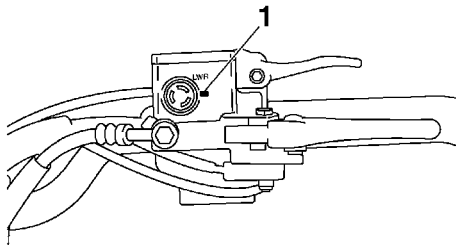

1. Lower level

Specified brake fluid:
DOT 4

EWS00820

WARNING

Improper maintenance can result in loss of braking ability. Observe these precautions:

- Insufficient brake fluid may allow air to enter the brake system, reducing braking performance.
- Clean the filler cap before removing. Use only DOT 4 brake fluid from a sealed container.
- Use only the specified brake fluid; otherwise, the rubber seals may deteriorate, causing leakage.
- Refill with the same type of brake fluid. Adding a brake fluid other than DOT 4 may result in a harmful chemical reaction.

Periodic maintenance and adjustment

- Be careful that water does not enter the brake fluid reservoir when refilling. Water will significantly lower the boiling point of the fluid and may result in vapor lock.

ECS01050

NOTICE

Brake fluid may damage painted surfaces or plastic parts. Always clean up spilled fluid immediately.

As the brake pads wear, it is normal for the brake fluid level to gradually go down. A low brake fluid level may indicate worn brake pads and/or brake system leakage; therefore, be sure to check the brake pads for wear and the brake system for leakage. If the brake fluid level goes down suddenly, have a Yamaha dealer check the cause before further riding.

Changing the brake fluid

EWS00471

WARNING

Make sure that the brake fluid and the following parts are replaced by a Yamaha dealer.

Brake fluid replacement is necessary when the following components are replaced during the periodic maintenance or if they are damaged or leaking.

- All oil seals of the master cylinder and caliper cylinder
- The brake hose

ESU14360

Extrovert drive sprocket (FX10/FX10RTRS/FX10XT75/ FX10M53S/FX10M62S)

Check the extrovert drive sprocket for wear and damage. Replace if necessary.

FX10/FX10RTRS/FX10M53S/ FX10M62S

To measure the drive sprocket wear

Measure the drive sprocket tooth width. If the tooth width is less than 28 mm (1.10 in), replace the drive sprocket.

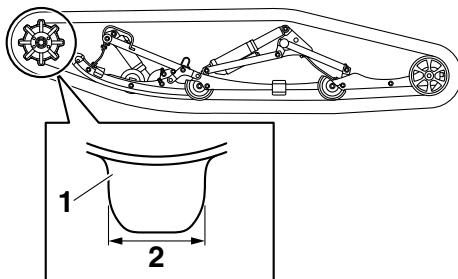

1. Drive sprocket tooth
2. Drive sprocket tooth width

FX10XT75

To measure the drive sprocket wear

Measure the drive sprocket tooth width at the measuring line shown. If the tooth width is 13 mm (0.51 in) or less, replace the drive sprocket.

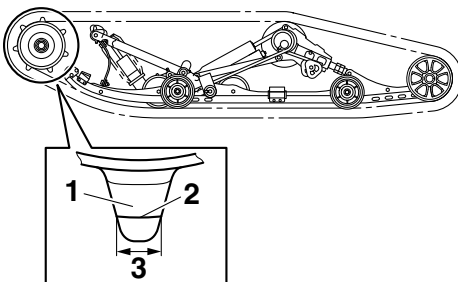

1. Drive sprocket tooth
2. Measuring line
3. Drive sprocket tooth width

Periodic maintenance and adjustment

ESU14420

Skis and ski runners

Checking the skis and ski runners

Check the skis and ski runners for wear and damage. Replace if necessary.

ECS00560

NOTICE

Avoid scratching the skis when loading and unloading the snowmobile, when riding in areas with little or no snow, or on sharp edges such as concrete, curbs, etc. This will wear or damage the skis.

FX10/FX10RTS/FX10XT/FX10XT75

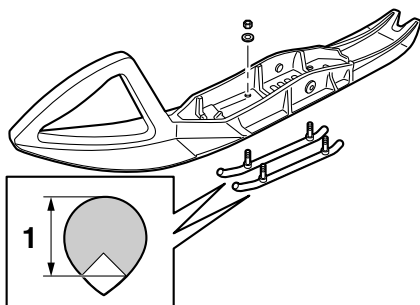

1. Ski runner wear limit

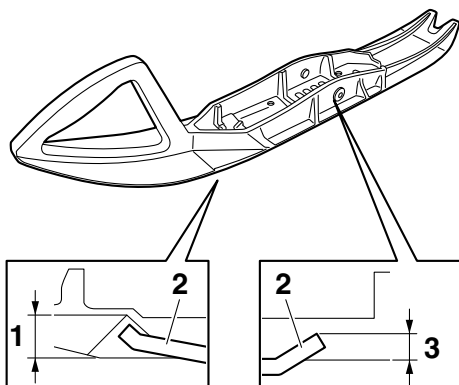

1. Ski wear limit (front)
2. Ski runner
3. Ski wear limit (rear)

- Ski runner wear limit:
6.0 mm (0.24 in)
Ski wear limit (front):
13.0 mm (0.51 in)
Ski wear limit (rear):
8.0 mm (0.31 in)

FX10M53S/FX10M62S

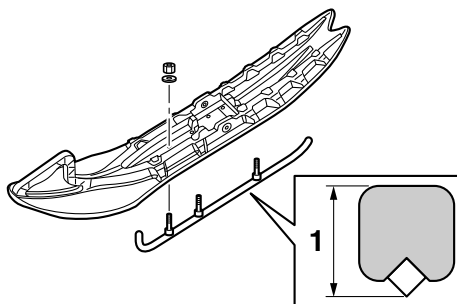

1. Ski runner wear limit

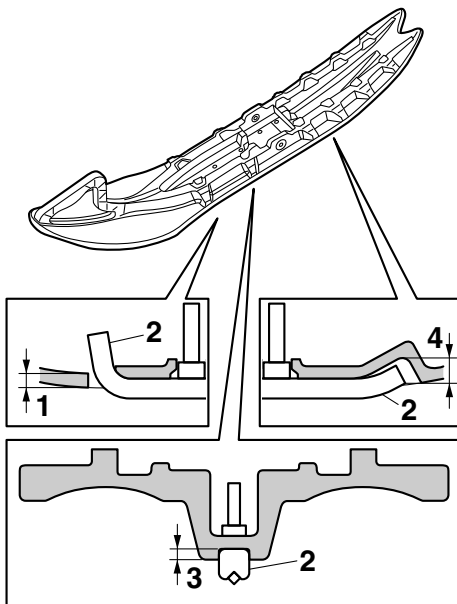

1. Ski wear limit (front)
2. Ski runner
3. Ski wear limit (center)
4. Ski wear limit (rear)

Periodic maintenance and adjustment

Ski runner wear limit:
8.0 mm (0.31 in)
Ski wear limit (front):
3.0 mm (0.12 in)
Ski wear limit (center):
1.0 mm (0.04 in)
Ski wear limit (rear):
10.0 mm (0.39 in)

Aligning the skis

1. Turn the handlebar so the skis face straight ahead.
2. Check the following for ski alignment:
 - Skis are facing forward.
 - Ski toe-out (distance A – distance B) is within specification.

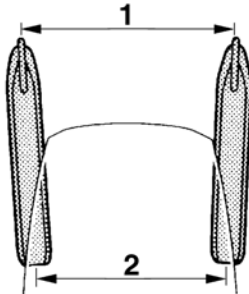

1. Distance A
2. Distance B

Ski toe-out (distance A – distance B):
0.0–15.0 mm (0.00–0.59 in)

TIP

Move the front tip of each ski fully inward before measuring or aligning.

3. If the alignment is not correct, consult a Yamaha dealer.

ESU12152

Steering system

Check the handlebar for excessive free play.

To check the handlebar

1. Push the handlebar up and down and back and forth.

2. Turn the handlebar slightly to the right and left.

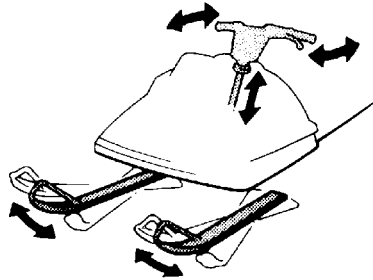

If excessive free play is felt, consult a Yamaha dealer.

ESU12176

Drive track and slide runners

Drive track

EWS00481



A broken track, track fittings or debris thrown by the drive track could be dangerous to an operator or bystanders. Observe the following precautions:

- Do not allow anyone to stand behind the snowmobile when the engine is running.
- When the rear of the snowmobile is raised to allow the drive track to spin, a suitable stand must be used to support the rear of the snowmobile. Never allow anyone to hold the rear of the snowmobile off the ground to allow the drive track to spin. Never allow anyone near a rotating drive track.
- Inspect the drive track condition frequently. Replace any damaged slide metal. Replace the drive track if it is damaged to the depth where fabric reinforcement material is visible or support rods are broken. Otherwise, track dam-

Periodic maintenance and adjustment

age or failure could result in loss of braking ability and snowmobile control, which could cause an accident.

Checking the drive track

EWS00490

WARNING

Do not operate the snowmobile if you find damage to the drive track, or if it has been maladjusted. Drive track damage or failure could result in loss of braking ability and snowmobile control, which could cause an accident.

Check the drive track alignment and deflection, and check the track for wear and damage.

Adjust or replace if necessary. (See the following section for more details.)

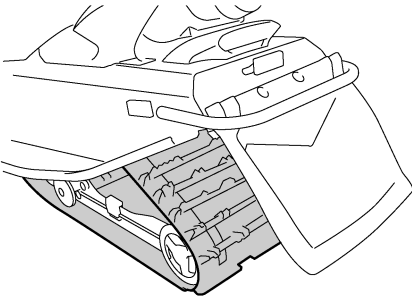

Checking the drive track alignment

1. Lift the rear of the snowmobile onto a suitable stand to raise the drive track off the ground.
2. Start the engine and rotate the drive track one or two turns. Stop the engine.
3. Check the drive track alignment with the slide runners. If the alignment is incorrect, adjust the drive track.

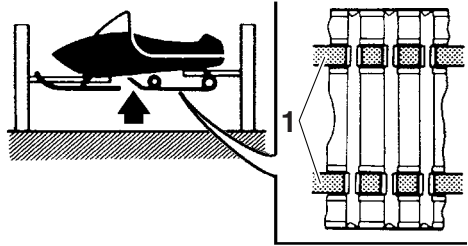

1. Slide runner

Measuring the drive track deflection

1. Lay the snowmobile on its side.
2. Measure the drive track deflection with a spring scale. Pull at the center of the drive track with a force of 100 N (10 kgf, 22 lbf).

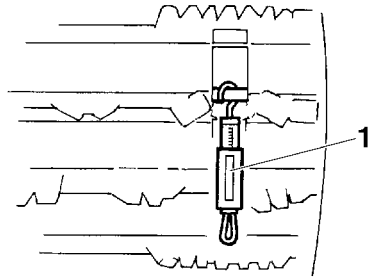

1. Spring scale

TIP

Measure the gap between the slide runner and the edge of the track window on both sides.

Periodic maintenance and adjustment

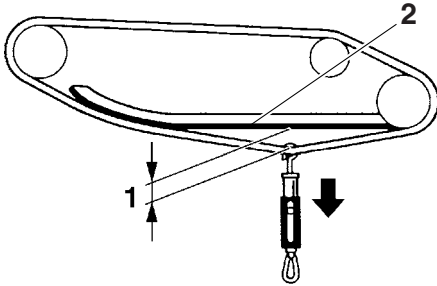

1. Drive track deflection
2. Slide runner

Standard drive track deflection:	
FX10	30.0–35.0 mm (1.18–1.38 in)
FX10M53S	40.0–45.0 mm (1.57–1.77 in)
FX10M62S	40.0–45.0 mm (1.57–1.77 in)
FX10RTS	30.0–35.0 mm (1.18–1.38 in)
FX10XT	25.0–30.0 mm (0.98–1.18 in)
FX10XT75	30.0–35.0 mm (1.18–1.38 in)

3. If the deflection is incorrect, adjust the drive track.

Adjusting the drive track alignment and deflection

1. Loosen the rear axle nut.

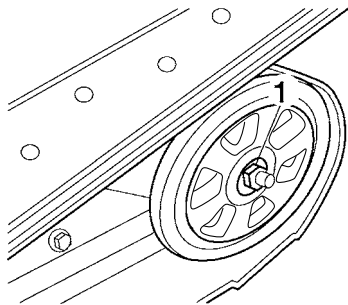

1. Rear axle nut
2. Lift the rear of the snowmobile onto a suitable stand to raise the drive track off the ground.

3. Start the engine and rotate the drive track one or two turns. Stop the engine.
4. Align the drive track by turning the left and right adjusting nuts.

Drive track alignment	Shifted to right	Shifted to left
Left adjusting nut	Turn out	Turn in
Right adjusting nut	Turn in	Turn out

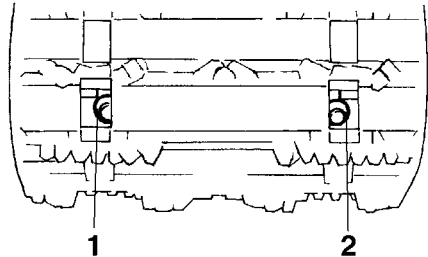

1. Left adjusting nut
2. Right adjusting nut

Shifted to right

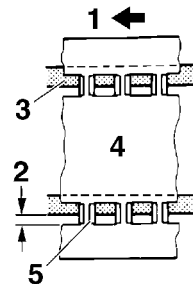

1. Forward
2. Gap
3. Slide runner
4. Drive track
5. Slide metal

Periodic maintenance and adjustment

Shifted to left

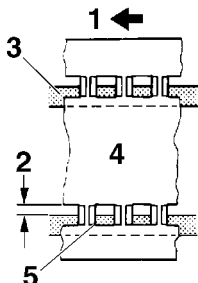

1. Forward
2. Gap
3. Slide runner
4. Drive track
5. Slide metal

5. Adjust the drive track deflection to specification. **NOTICE: The right and left adjusting nuts should be turned an equal amount.** [ECS00592]

Drive track deflection	More than specified	Less than specified
Left adjusting nut	Turn in	Turn out
Right adjusting nut	Turn in	Turn out

6. Recheck alignment and deflection. If necessary, repeat steps 3 to 5 until the proper adjustment is achieved.
7. Lower the snowmobile to the ground.
8. Tighten the rear axle nut.

Rear axle nut tightening torque:
75 Nm (7.5 m-kgf, 54 ft-lbf)

Slide runners

Check the slide runners for wear and damage.

If the slide runners reach the wear limit, they should be replaced.

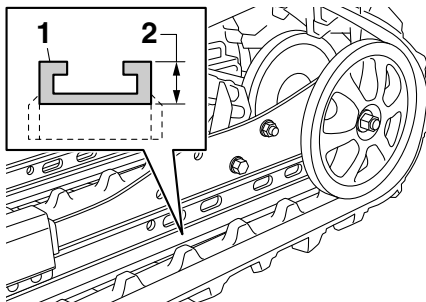

1. Slide runner
2. Wear limit height

Slide runner wear limit height:
10.5 mm (0.41 in)

ECS00350

NOTICE

Ride on fresh snow frequently. Operating on ice or hard-packed snow will rapidly wear the slide runners.

ESU12182

High-profile pattern drive track

FX10XT75/FX10M53S/FX10M62S

This snowmobile is originally equipped with a high-profile pattern drive track with a lug height of 38 mm (1.5 in.) or more specifically for use in deep snow riding conditions.

Therefore, avoid prolonged operation on hard surfaces such as ice, hard-packed snow, dirt, etc., to extend the life of the track and slide runners.

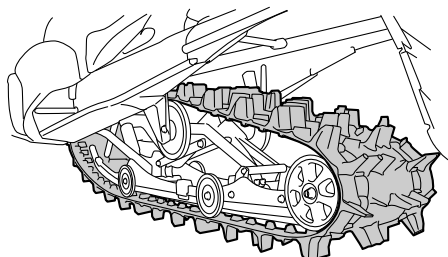

Periodic maintenance and adjustment

ECS00610

NOTICE

- Only use in deep snow riding conditions.
- Operation on areas with light snowfall, ice, hard-packed snow, dirt, or grass will result in rapid wear or damage to the track and slide runners from lack of snow which serves as a lubricant.

ESU12198

Lubrication

Lubricate the following points with the specified grease.

EWS00511

WARNING

Do not grease the throttle cable because it could become frozen, which could cause loss of control. Apply a dab of grease onto the cable end only.

TIP

For parts equipped with a grease nipple, use a grease gun.

Lubricants:

Brake lever:

Silicone grease

Other lubrication points:

Low-temperature grease

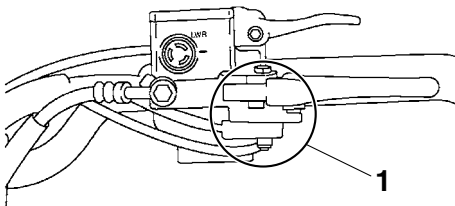

1. Lubrication point

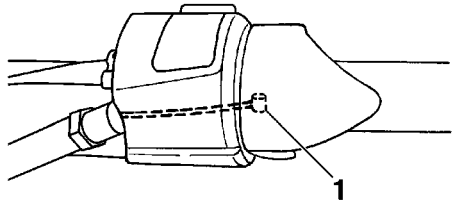

1. Throttle cable end

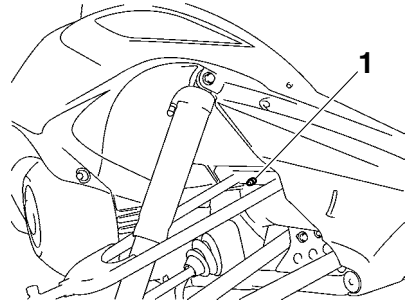

1. Grease nipple

FX10/FX10RTRS

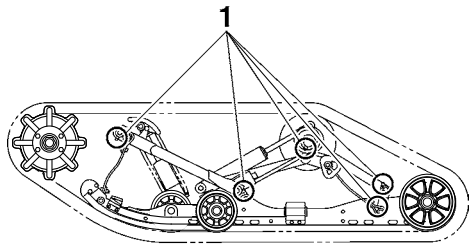

1. Grease nipple

Periodic maintenance and adjustment

FX10XT/FX10XT75

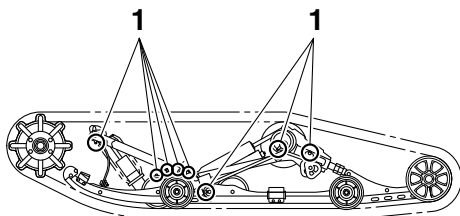

1. Grease nipple

FX10M53S/FX10M62S

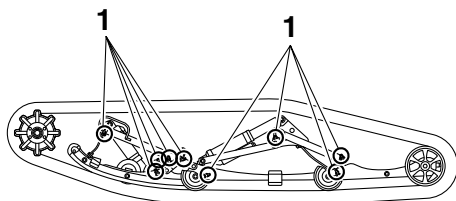

1. Grease nipple

ESU12852

Replacing a headlight bulb

1. Remove the shroud. (See page 63 for removal procedures.)
2. Disconnect the headlight coupler.
3. Remove the bulb holder cover.

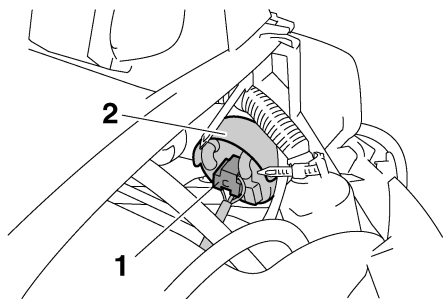

1. Headlight coupler
2. Bulb holder cover

4. Unhook the headlight bulb holder, and then remove the burnt-out bulb.

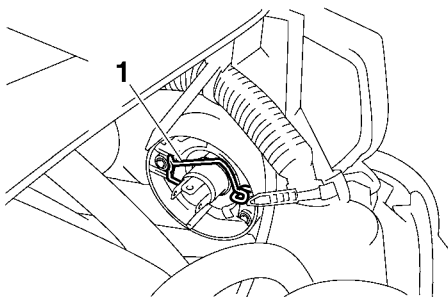

1. Bulb holder

5. Install the new bulb, and then hook the bulb holder onto the headlight unit.
NOTICE: Keep oil and your hands away from the glass part of the bulb or its life and illumination will be affected. If the glass is oil stained, thoroughly clean it with a cloth moistened with alcohol or lacquer thinner. [ECS00621]

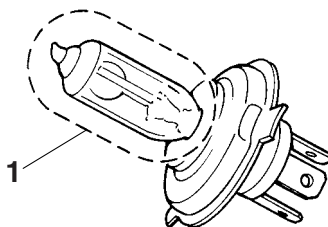

1. Do not touch the glass part of the bulb.

Bulb type:
Halogen bulb

6. Install the bulb holder cover, and then connect the headlight coupler.
7. Install the shroud.

ESU12861

Adjusting the headlight beams

1. Remove the shroud. (See page 63 for removal procedures.)

Periodic maintenance and adjustment

- Turn the headlight beam adjusting screw in or out to adjust the headlight beams. To lower the headlight beams, turn the headlight beam adjusting screw in direction (a). To raise the headlight beams, turn the headlight beam adjusting screw in direction (b).

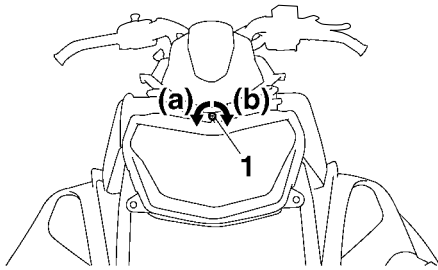

1. Headlight beam adjusting screw

- Install the shroud.

ESU12290

Fittings and fasteners

Check the tightness of the fittings and fasteners.

Tighten in proper sequence and torque if necessary.

ESU13890

Battery

The battery is located behind the right side cover. (See page 63 for right side cover removal procedures.)

This model is equipped with a VRLA (Valve Regulated Lead Acid) battery. There is no need to check the electrolyte or to add distilled water. However, the battery lead connections need to be checked and, if necessary, tightened.

EWS00540

WARNING

Battery electrolyte is poisonous and dangerous. It contains sulfuric acid and can cause severe burns. Avoid contact with skin, eyes, or clothing.

ANTIDOTE:

- **EXTERNAL:** Flush with water.
- **INTERNAL:** Drink large quantities of water or milk. Follow with milk of magnesia, beaten egg, or vegetable oil. Call physician immediately.
- **EYES:** Flush with water for 15 minutes and get prompt medical attention.

Batteries produce explosive gases. Keep sparks, flame, cigarettes, etc. away. Ventilate when charging or using in an enclosed space. Always shield your eyes when working near batteries.

KEEP OUT OF THE REACH OF CHILDREN.

Charge or have a Yamaha dealer charge the battery as soon as possible if it seems to have discharged. Keep in mind that the battery tends to discharge more quickly if the snowmobile is equipped with electrical accessories.

EWS00610

WARNING

- **Never smoke around the battery while it is being charged. Sparks may ignite the hydrogen gas created by the battery.**
- **Disconnect the negative lead first, then the positive lead from the battery.**
- **Connect the positive lead first, then the negative lead to the battery when installing the battery.**
- **Never connect the battery to or disconnect it from the snowmobile while it is being charged. Sparks may ignite the hydrogen gas created by the battery.**
- **Make sure that the battery terminals are tight.**

Periodic maintenance and adjustment

ECS00843

NOTICE

- To charge a VRLA (Valve Regulated Lead Acid) battery, a special (constant-voltage) battery charger is required. Using a conventional battery charger will damage the battery.
- Do not charge the battery quickly.

ESU12874

Replacing a fuse

EWS00550

WARNING

Be sure to use the specified fuse. A wrong fuse could cause electrical system damage or A FIRE HAZARD.

ECS00631

NOTICE

Be sure to turn the main switch to the off position and disconnect the negative battery lead to prevent accidental short-circuiting.

The main fuse, the fuel injection system fuse, and the fuse box are located behind the right side cover. (See page 63 for right side cover removal procedures.)

1. Remove the shroud and the right side cover. (See page 63 for removal procedures.)
2. Disconnect the negative battery lead.

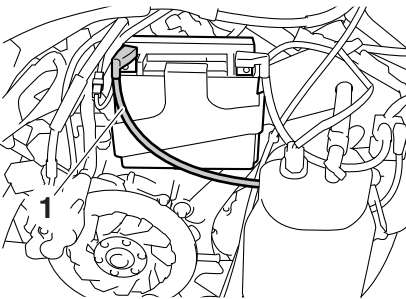

1. Negative battery lead

3. Replace the blown fuse with one of the proper amperage.

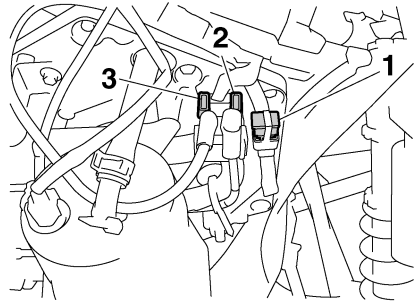

1. Main fuse
2. Spare fuse
3. Fuel injection system fuse

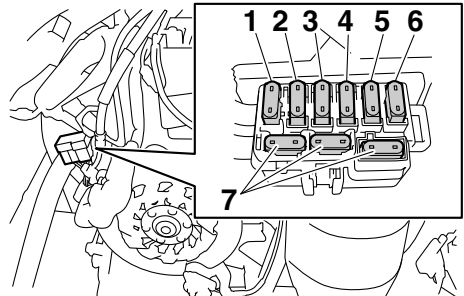

1. "IGN" (ignition) fuse
2. "S/H" (helmet shield heater jack) fuse (CANADA)
3. "FAN" (radiator fan) fuse
4. "SIG" (signaling system) fuse
5. "DC TERM" (auxiliary DC jack) fuse
6. "HEAD" (headlight) fuse
7. Spare fuse

Periodic maintenance and adjustment

Specified fuses:

Main fuse:

40.0 A

Fuel injection system fuse:

10.0 A

Headlight fuse:

20.0 A

Signaling system fuse:

3.0 A

Auxiliary DC jack fuse:

3.0 A

Ignition fuse:

20.0 A

Radiator fan fuse:

10.0 A

Helmet shield heater jack fuse:

FX10 3.0 A

FX10M53S 3.0 A (CAN)

FX10M62S 3.0 A (CAN)

FX10RTRS 3.0 A (CAN)

FX10XT 3.0 A (CAN)

FX10XT75 3.0 A (CAN)

Spare fuses:

20.0 A, 10.0 A, 3.0 A

4. Connect the negative battery lead.
5. Install the right side cover and the shroud.

TIP

If the fuse immediately blows again, ask a Yamaha dealer to inspect the snowmobile.

ESU12887

Engine turns over but does not start

1. Fuel system

- No fuel supplied to combustion chamber
 - No fuel in tank:
Supply fuel.
↓
 - Clogged fuel line:
Clean fuel line.
↓
 - Clogged injector:
Ask a Yamaha dealer to inspect.
- Fuel supplied to combustion chamber
 - Flooded engine:
Crank engine or wipe the spark plugs dry.

2. Electrical system

- Poor spark or no spark
 - Spark plugs are dirty with carbon or are wet:
Remove carbon or wipe the spark plugs dry. Replace if necessary.
↓
 - Faulty ignition system:
Ask a Yamaha dealer to inspect.
↓
 - T.O.R.S. malfunction:
Disconnect the throttle switch connectors and connect the wire harness connectors together to bypass the T.O.R.S. **WARNING! Before bypassing the T.O.R.S., make sure that the throttle returns properly to the fully closed position. The T.O.R.S. is an important safety device; in the case of a malfunction, take the snowmobile to a Yamaha dealer immediately for repair.**

[EWS00561]

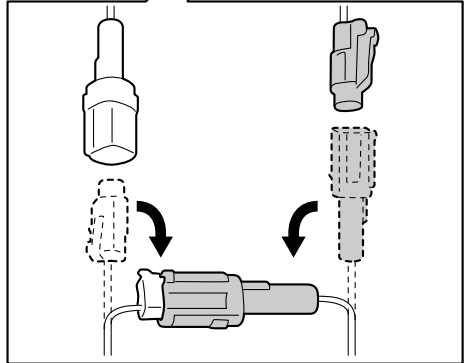
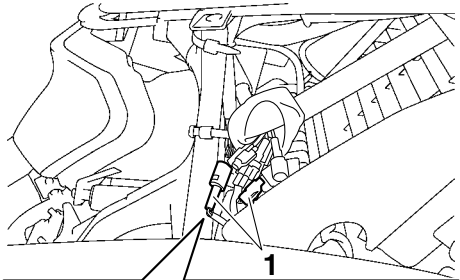

1. Throttle switch connector

3. Compression

- Insufficient
 - Loose cylinder head nuts:
Tighten nuts properly.
↓
 - Worn or damaged gasket:
Replace gasket.
↓
 - Worn or damaged piston and cylinder:
Ask a Yamaha dealer to inspect.

Discharged battery

If the battery is discharged, the engine can be started using a fully-charged 12-volt battery and jumper cables.

EWS00580



- Connect the jumper cables only to the battery terminals. Do not connect them to the frame or any wire or other lead.

Troubleshooting

- **When connecting the jumper cables, do not contact the jumper cables to each other or to the frame or any metal part of the snowmobile. This can cause electrical system damage or A FIRE HAZARD.**

1. Apply the parking brake and turn the main switch to the off position.
2. Remove the shroud and the right side cover. (See page 63 for removal procedures.)
3. Connect the red (+) jumper cable to the positive (+) terminal of the discharged battery.
4. Connect the other end of the red (+) jumper cable to the positive (+) terminal of the booster battery.
5. Connect the black (-) jumper cable to the negative (-) terminal of the booster battery.
6. Connect the other end of the black (-) jumper cable to the negative (-) terminal of the discharged battery. **NOTICE: Do not reverse the connections! Make sure that all connections are secure and correct before attempting to start the engine. Any wrong connection could damage the electrical system.**

[ECS00671]

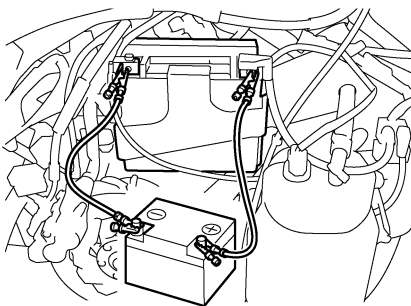

7. Start the engine.
8. Disconnect the black (-) jumper cable from the negative (-) terminal of the discharged battery.

9. Disconnect the black (-) jumper cable from the negative (-) terminal of the battery used to jump-start the engine.
10. Disconnect the red (+) jumper cable from the positive (+) terminal of the battery used to jump-start the engine.
11. Disconnect the red (+) jumper cable from the positive (+) terminal of the discharged battery.
12. Install the right side cover and the shroud.

Electric starter does not operate or operates slowly

- Engine stop switch is pushed in: Pull it out.
- Faulty wire connections: Check connections or ask a Yamaha dealer to inspect.
- Discharged battery: Charge battery or see “Discharged battery” above.
- Seized engine: Seizure is caused by poor lubrication, inadequate fuel, or an air leak. Ask a Yamaha dealer to inspect.

Engine power is low

- Low coolant temperature indicator light is flashing: Warm the engine up.
- Faulty spark plugs: Clean or replace the spark plugs.
- Improper fuel flow: See “Fuel system” above.
- Incorrect V-belt clutch settings for altitude or conditions: Ask a Yamaha dealer to inspect.

Engine constantly backfires or misfires

- Faulty spark plugs: Replace the spark plugs.
- Clogged fuel system: See “Fuel system” above.
- Malfunctioning T.O.R.S.: See “Electrical system” above.

Engine overheats

- Insufficient coolant: Add coolant.

- Air in cooling system: Bleed the cooling system or ask a Yamaha dealer to inspect.
- Leaking coolant: Ask a Yamaha dealer to inspect.
- Worn or damaged bearings: Ask a Yamaha dealer to inspect.
- Worn or damaged V-belt with flat spots: Replace.

Snowmobile does not move

- Malfunctioning V-belt clutch: Ask a Yamaha dealer to inspect.
- Drive track does not move: Foreign object is caught in the drive track, or slide runners have melted to the slide metal due to lack of lubrication.
- Tight, loose, or broken drive chain: Ask a Yamaha dealer to inspect.
- Worn or damaged idler wheels or shafts: Ask a Yamaha dealer to inspect.
- Worn or damaged drive track: Ask a Yamaha dealer to inspect.

V-belt twists

- Improper V-belt: Replace with the correct V-belt.
- Incorrect V-belt clutch offset: Ask a Yamaha dealer to inspect.
- Loose or broken engine mount(s): Ask a Yamaha dealer to inspect.

V-belt slips or becomes extremely hot

- Oily or dirty V-belt or primary and secondary sheave assembly surfaces: Clean.
- Problem with the driveline: See “V-belt twists” above.

Engine does not upshift or downshift properly or engages harshly

- Worn or damaged V-belt: Replace the V-belt or ask a Yamaha dealer to inspect.
- Incorrect V-belt clutch settings for altitude or conditions: Ask a Yamaha dealer to inspect.
- Worn or sticking primary sheave assembly: Ask a Yamaha dealer to inspect.
- Worn or sticking secondary sheave assembly: Ask a Yamaha dealer to inspect.

Noise or excessive vibration in drive chain and sprockets

- Broken V-belt clutch components: Ask a Yamaha dealer to inspect.

Storage

ESU12444

Long-term storage of your snowmobile will require some preventive procedures to guard against deterioration.

Engine

Perform the following steps to protect the cylinders, piston rings, etc., from corrosion.

1. Remove the spark plug caps and spark plugs.
2. Pour a teaspoonful of engine oil into each spark plug bore.
3. Install the spark plug caps onto the spark plugs, and then place the spark plugs on the cylinder head so that the electrodes are grounded. (This will limit sparking during the next step.)
4. Turn the engine over several times with the starter. (This will coat the cylinder walls with oil.) **WARNING! To prevent damage or injury from sparking, make sure to ground the spark plug electrodes while turning the engine over.**

[EWS00601]

5. Remove the spark plug caps from the spark plugs, and then install the spark plugs and the spark plug caps.

Fuel

Add a fuel stabilizer to the fuel tank to help prevent fuel oxidation and gum and varnish deposits, and to inhibit corrosion in the fuel system and injectors. In areas where oxygenated fuel (gasohol) is used, consult a Yamaha dealer.

Chassis

1. Lubricate all specified points with grease. (See page 88 for detailed information about the lubrication points.)
2. Loosen the drive track and block up the chassis so that the track is suspended above the ground.

3. Clean the exterior of the snowmobile and apply a rust inhibitor.
4. Store the snowmobile in a dry, well-ventilated place with a porous cover placed over it.
5. Keep the snowmobile on a level surface during storage or while transporting.

ECS00870

NOTICE

- **Improper cleaning can damage plastic parts such as shroud, covers, windshields, headlight lenses, meter lenses, etc. Use only a soft, clean cloth or sponge with mild detergent and water to clean plastic.**
 - **Do not use any harsh chemical products on plastic parts. Be sure to avoid using cloths or sponges which have been in contact with strong or abrasive cleaning products, solvent or thinner, fuel (gasoline), rust removers or inhibitors, brake fluid, antifreeze or electrolyte.**
 - **Do not use high-pressure washers or steam-jet cleaners since they cause water seepage and deterioration in the following areas: seals (of the slide rail suspension, front suspension and brakes), electric components (couplers, connectors, instruments, switches and lights), breather hoses and vents.**
 - **For snowmobiles equipped with a windshield: Do not use strong cleaners or hard sponges as they will cause dulling or scratching. Some cleaning compounds for plastic may leave scratches on the windshield. Test the product on a small hidden part of the windshield to make sure that it does not leave any marks. If the windshield is scratched, use a quality plastic polishing compound after washing.**
-

Battery

Remove the battery from the snowmobile. Store it in a cool, dry place that is above 0 °C (32 °F), but less than 30 °C (90 °F). Check the condition of the battery once a month, and charge it as necessary. **NOTICE: Always keep the battery charged. Storing a discharged battery can cause permanent battery damage.**^[ECS00691]

TIP

Before installing the battery, have a Yamaha dealer inspect and fully charge it.

Specifications

ESU1246C

Dimensions:

Overall length:

- FX10 2820 mm (111.0 in)
- FX10M53S 3405 mm (134.1 in)
- FX10M62S 3405 mm (134.1 in)
- FX10RTRS 2820 mm (111.0 in)
- FX10XT 3060 mm (120.5 in)
- FX10XT75 3060 mm (120.5 in)

Overall width:

- FX10 1205 mm (47.4 in)
- FX10M53S 1250 mm (49.2 in)
- FX10M62S 1250 mm (49.2 in)
- FX10RTRS 1205 mm (47.4 in)
- FX10XT 1205 mm (47.4 in)
- FX10XT75 1205 mm (47.4 in)

Overall height:

- FX10 1160 mm (45.7 in)
- FX10M53S 1195 mm (47.0 in)
- FX10M62S 1195 mm (47.0 in)
- FX10RTRS 1140 mm (44.9 in)
- FX10XT 1160 mm (45.7 in)
- FX10XT75 1160 mm (45.7 in)

Weight:

With oil and fuel:

- FX10 269.0 kg (593 lb)
- FX10M53S 277.0 kg (611 lb) (CAN)
- FX10M62S 278.0 kg (613 lb) (CAN)
- FX10RTRS 272.0 kg (600 lb) (CAN)
- FX10XT 278.0 kg (613 lb) (CAN)
- FX10XT75 283.0 kg (624 lb) (CAN)

Mass in running order:

- FX10M53S 278.0 kg (613 lb) (FIN)(SWE)
- FX10M62S 279.0 kg (615 lb) (FIN)(RUS)(SWE)
- FX10RTRS 272.0 kg (600 lb) (FIN)(SWE)
- FX10XT 278.0 kg (613 lb) (FIN)(RUS)(SWE)
- FX10XT75 283.0 kg (624 lb) (FIN)(RUS)(SWE)

Ski stance:

- FX10 1050 mm (41.3 in)
- FX10M53S 1009 mm (39.7 in)
- FX10M62S 1009 mm (39.7 in)
- FX10RTRS 1050 mm (41.3 in)
- FX10XT 1050 mm (41.3 in)
- FX10XT75 1050 mm (41.3 in)

Engine:

Type:

Liquid cooled 4-stroke, 12 valves

Cylinder arrangement:

Inline 3-cylinder

Displacement:

1049 cm³

Bore × stroke:

82.0 × 66.2 mm (3.23 × 2.61 in)

Idling speed:

1450–1550 r/min

Engine oil:

Recommended grade:

API service SG type or higher, JASO standard MA

Recommended brand:

YAMALUBE

Type:

SAE 0W-30

Fuel injection:

ID mark:

8GL1 10

Fuel:

Type:

- FX10 REGULAR UNLEADED GASOLINE ONLY
- FX10M53S Min 95 RON UNLEADED GASOLINE ONLY (FIN)(SWE)
- FX10M53S REGULAR UNLEADED GASOLINE ONLY (CAN)
- FX10M62S Min 91 RON UNLEADED GASOLINE ONLY (RUS)
- FX10M62S Min 95 RON UNLEADED GASOLINE ONLY (FIN)(SWE)
- FX10M62S REGULAR UNLEADED GASOLINE ONLY (CAN)
- FX10RTRS Min 95 RON UNLEADED GASOLINE ONLY (FIN)(SWE)
- FX10RTRS REGULAR UNLEADED GASOLINE ONLY (CAN)
- FX10XT Min 91 RON UNLEADED GASOLINE ONLY (RUS)

Specifications

FX10XT Min 95 RON UNLEADED
GASOLINE ONLY (FIN)(SWE)
FX10XT REGULAR UNLEADED
GASOLINE ONLY (CAN)
FX10XT75 Min 91 RON UNLEADED
GASOLINE ONLY (RUS)
FX10XT75 Min 95 RON UNLEADED
GASOLINE ONLY (FIN)(SWE)
FX10XT75 REGULAR UNLEADED
GASOLINE ONLY (CAN)

Minimum pump octane (R+M)/2:

FX10 86
FX10M53S 86 (CAN)
FX10M62S 86 (CAN)
FX10RTRS 86 (CAN)
FX10XT 86 (CAN)
FX10XT75 86 (CAN)

Minimum research octane:

FX10M53S 95 (FIN)(SWE)
FX10M62S 91 (RUS)
FX10M62S 95 (FIN)(SWE)
FX10RTRS 95 (FIN)(SWE)
FX10XT 91 (RUS)
FX10XT 95 (FIN)(SWE)
FX10XT75 91 (RUS)
FX10XT75 95 (FIN)(SWE)

Starting system:

Electric starter

Noise level and vibration level:

Noise level (77/311/EEC):

FX10M53S 91.9 dB(A)@4375 r/min
(FIN)(SWE)
FX10M62S 91.9 dB(A)@4375 r/min
(FIN)(SWE)
FX10RTRS 91.9 dB(A)@4375 r/min
(FIN)(SWE)
FX10XT 91.9 dB(A)@4375 r/min
(FIN)(SWE)
FX10XT75 91.9 dB(A)@4375 r/min
(FIN)(SWE)

A-weighted sound power level:

FX10M53S 100.0 dB(A)@4375 r/min
(FIN)(SWE)
FX10M62S 100.0 dB(A)@4375 r/min
(FIN)(SWE)
FX10RTRS 100.0 dB(A)@4375 r/min
(FIN)(SWE)
FX10XT 100.0 dB(A)@4375 r/min
(FIN)(SWE)
FX10XT75 100.0 dB(A)@4375 r/min
(FIN)(SWE)

Vibration on seat (EN1032, ISO 5008):

FX10M53S Not exceed 0.5 m/s²
(FIN)(SWE)
FX10M62S Not exceed 0.5 m/s²
(FIN)(SWE)
FX10RTRS Not exceed 0.5 m/s²
(FIN)(SWE)
FX10XT Not exceed 0.5 m/s² (FIN)(SWE)
FX10XT75 Not exceed 0.5 m/s²
(FIN)(SWE)

Vibration on handlebar (EN1032, ISO 5008):

FX10M53S Not exceed 2.5 m/s²
(FIN)(SWE)
FX10M62S Not exceed 2.5 m/s²
(FIN)(SWE)
FX10RTRS Not exceed 2.5 m/s²
(FIN)(SWE)
FX10XT Not exceed 2.5 m/s² (FIN)(SWE)
FX10XT75 Not exceed 2.5 m/s²
(FIN)(SWE)

Chassis:

Drive track:

Material:

Molded rubber, fiberglass-rod reinforced

Type:

FX10 Extrovert drive type
FX10M53S Extrovert drive type
FX10M62S Extrovert drive type
FX10RTRS Extrovert drive type
FX10XT Internal drive type
FX10XT75 Extrovert drive type

Width:

381 mm (15.0 in)

Deflection:

FX10 30.0–35.0 mm (1.18–1.38 in)
FX10M53S 40.0–45.0 mm (1.57–1.77 in)
FX10M62S 40.0–45.0 mm (1.57–1.77 in)
FX10RTRS 30.0–35.0 mm (1.18–1.38 in)
FX10XT 25.0–30.0 mm (0.98–1.18 in)
FX10XT75 30.0–35.0 mm (1.18–1.38 in)

Length on ground:

FX10 810 mm (31.9 in)
FX10M53S 1095 mm (43.1 in)
FX10M62S 1209 mm (47.6 in)
FX10RTRS 810 mm (31.9 in)
FX10XT 1051 mm (41.4 in)
FX10XT75 1051 mm (41.4 in)

Rear suspension:

Type:

Slide rail suspension

Specifications

Track sprocket wheel:

Material:

Polyethylene

Number of teeth:

FX10 8

FX10M53S 7

FX10M62S 7

FX10RTRS 8

FX10XT 9

FX10XT75 9

Transmission:

Clutch type:

Automatic centrifugal engagement

Overall reduction ratio:

FX10 7.06–1.86 : 1

FX10M53S 6.91–1.82 : 1 (FIN)(SWE)

FX10M53S 8.44–2.22 : 1 (CAN)

FX10M62S 6.91–1.82 : 1

(FIN)(RUS)(SWE)

FX10M62S 8.44–2.22 : 1 (CAN)

FX10RTRS 7.06–1.86 : 1

FX10XT 7.06–1.86 : 1

FX10XT75 7.41–1.95 : 1

Sheave distance:

267.0–270.0 mm (10.51–10.63 in)

Sheave offset:

13.5–16.5 mm (0.53–0.65 in)

Engagement speed (Subject to change according to elevation settings.):

FX10 3550–3950 r/min

FX10M53S 3100–3500 r/min (FIN)(SWE)

FX10M53S 3300–3700 r/min (CAN)

FX10M62S 3100–3500 r/min

(FIN)(RUS)(SWE)

FX10M62S 3300–3700 r/min (CAN)

FX10RTRS 3900–4300 r/min

FX10XT 3550–3950 r/min

FX10XT75 3550–3950 r/min

Shift speed [Subject to change according to elevation settings. Usually achieved after approximately 800 m (0.5 mi) traveled.]:

8500–9000 r/min

Drive chain type:

Silent chain enclosed in oil bath

Drive chain housing oil:

Type:

SAE 75W or 80W API GL-3 Gear oil

Capacity:

0.20 L (0.21 US qt, 0.18 Imp.qt)

Reverse system:

Yes

Primary reduction ratio:

3.80–1.00 : 1

Secondary reduction ratio:

FX10 39/21 (1.86)

FX10M53S 40/18 (2.22) (CAN)

FX10M53S 40/22 (1.82) (FIN)(SWE)

FX10M62S 40/18 (2.22) (CAN)

FX10M62S 40/22 (1.82)

(FIN)(RUS)(SWE)

FX10RTRS 39/21 (1.86)

FX10XT 39/21 (1.86)

FX10XT75 39/20 (1.95)

Secondary reduction ratio [R]:

FX10 2.38

FX10M53S 2.27 (FIN)(SWE)

FX10M53S 2.78 (CAN)

FX10M62S 2.27 (FIN)(RUS)(SWE)

FX10M62S 2.78 (CAN)

FX10RTRS 2.38

FX10XT 2.38

FX10XT75 2.50

Fuel tank capacity:

27.7 L (7.32 US gal, 6.09 Imp.gal)

Engine oil quantity:

With oil filter cartridge replacement:

3.2 L (3.38 US qt, 2.82 Imp.qt)

Without oil filter cartridge replacement:

3.0 L (3.17 US qt, 2.64 Imp.qt)

Total amount:

3.9 L (4.12 US qt, 3.43 Imp.qt)

Brake:

Type:

Hydraulic disc type (ventilated disc)

Operation:

Handle lever, left-hand operated

Throttle:

Operation:

Handle lever, right-hand operated

Electrical system:

Ignition system:

T.C.I.

Spark plug:

Manufacturer:

NGK

Model:

CR9E

Gap:

0.7–0.8 mm (0.028–0.031 in)

Battery:

Model:

YTX20L-BS

Voltage, capacity:

12 V, 18.0 Ah

Ten-hour rate amperage:

1.8 A

Bulb voltage, wattage × quantity:

Headlight:

12 V, 60/55 W × 2

Headlight bulb type:

Halogen bulb

Tail/brake light:

LED

Meter lighting:

LED

High beam indicator light:

LED

Warning light:

LED

Low coolant temperature indicator light:

LED

ESU14250

For EUR only

The figures quoted are emission levels and are not necessarily safe working levels. Whilst there is a correlation between the emission and exposure levels, this cannot be used reliably to determine whether or not further precautions are required. Factors that influence the actual level of exposure of work-force include the characteristics of the work room, the other sources of noise, etc. i.e. the number of machines and other adjacent processes, and the length of time for which an operator is exposed to the noise. Also the permissible exposure level can vary from country. This information, however, will enable the user of the machine to make a better evaluation of the hazard and risk.

Consumer information

ESU14220

Identification number records

Record the frame serial number and engine serial number (Primary ID) in the spaces provided for assistance when ordering spare parts from a Yamaha dealer.

Also, record and keep the ID numbers in a separate place in case the snowmobile is stolen.

Frame serial number

The frame serial number is the seventeen-digit number stamped on the frame of the snowmobile.

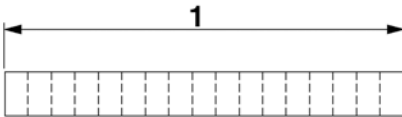
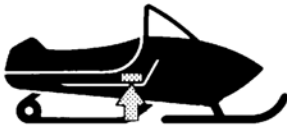

1. Frame serial number

Engine serial number (Primary ID)

The engine serial number is stamped in the location as shown.

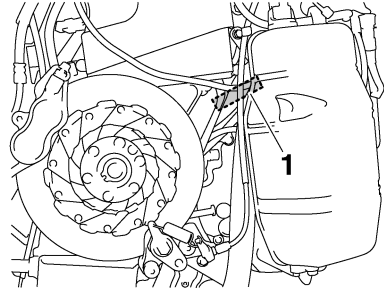

1. Engine serial number

ESU13461

Vehicle Emission Control Information label (for CANADA)

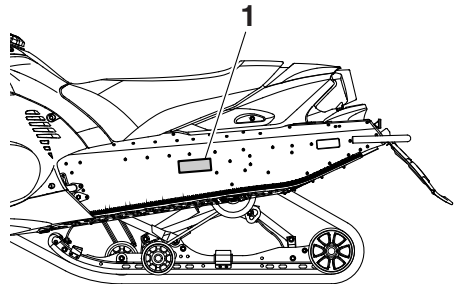

1. Vehicle Emission Control Information label

The Vehicle Emission Control Information label is affixed at the location in the illustration. This label shows specifications related to exhaust emissions as required by federal law, state law and Environment Canada.

ESU12491

WARRANTY

If doubt exists as to the cause and cure of a problem, consult your authorized Yamaha snowmobile dealer. This is especially important during the warranty period, as unauthorized, haphazard, or improper repairs can void the warranty. Remember that your autho-

rized Yamaha dealer has the special tools, techniques, and spare parts necessary for proper repair of your snowmobile.

Always consult your Yamaha dealer if you are in doubt as to proper specifications and/or maintenance procedures. Occasionally, printing errors or production changes will result in incorrect documentation in this manual.

Until you are thoroughly familiar with this model, consult your Yamaha dealer before attempting any maintenance. Should further maintenance or service information be desired, service manuals can be purchased from your local authorized Yamaha snowmobile dealer.

Index

- A**
Air filter, checking 67
Auxiliary DC jack
(FX10M53S/FX10M62S) 28
- B**
Battery 90
Brake and parking brake 79
Brake lever 28
Break-in 51
- C**
Center and rear shock absorbers,
or rear shock absorber, adjusting
damping forces 44
Center shock absorber and rear shock
absorber, adjusting air pressure
(FX10M53S/FX10M62S) 40
Center shock absorber and rear torsion
springs, adjusting spring preload
(FX10/FX10RTRS/FX10XT/
FX10XT75) 39
Control rods, adjusting
(FX10XT/FX10XT75) 46
Coolant temperature warning indicator 26
Cooling system 74
- D**
Drive chain housing 78
Drive guard 30
Drive track and slide runners 84
Drive track, high-profile pattern 87
Drive track life, maximizing 55
Driving 56
- E**
Engine oil and oil filter cartridge 69
Engine stop switch 27
Extrovert drive sprocket
(FX10/FX10RTRS/FX10XT75/
FX10M53S/FX10M62S) 82
- F**
Fittings and fasteners 90
Fuel 32
Fuel level warning indicator 25
Fuel meter and grip/thumb warmer level
indicator 24
Fuse, replacing 91
- G**
General maintenance and lubrication
chart 61
Grip/thumb warmer adjusting switch 27
- H**
Headlight beam switch 27
Headlight beams, adjusting 89
Headlight bulb, replacing 89
High beam indicator light 23
High-altitude settings 68
- I**
Identification numbers 102
- L**
Location of the important labels 1
Low coolant temperature indicator light ... 23
Lubrication 88
- M**
Main switch 21
Multi-function meter unit 22
- O**
Oil level/pressure warning indicator 25
- P**
Parking brake lever 29
Part locations 19
Periodic maintenance chart for the
emission control system 60
Pre-operation check list 48
- R**
Recommended equipment 63
Riding your snowmobile 51
- S**
Safety information 16
Self-diagnosis device 26
Shift lever 29
Shock absorbers, front, adjusting air
pressure
(FX10RTRS/FX10M53S/FX10M62S) ... 35
Shock absorbers, front, adjusting
damping forces (FX10RTRS) 38
Shock absorbers, front, adjusting spring
preload (FX10/FX10XT/FX10XT75) 34
Shroud and covers, removing and
installing 63
Skis and ski runners 83
Spark plugs, checking 65
Specifications 98

Starting the engine	50
Steering system	84
Stopping the engine	57
Storage.....	96
Storage pouch.....	31
Strap (FX10M53S/FX10M62S)	56
Suspension	33
T	
Throttle lever	21
Throttle lever free play, adjusting	66
Throttle override system (T.O.R.S.)	21
Throttle override system (T.O.R.S.), checking.....	66
Tool kit.....	63
Transporting	58
Troubleshooting	93
V	
Valve clearance.....	68
V-belt.....	76
Vehicle Emission Control Information label (for CANADA).....	102



Printed in Japan
2012.06-0.5×1 CR

Printed on recycled paper